

MicroHAWK Accessory Guide

This guide contains instructions for how to install the following accessories on a MicroHAWK ID-20, ID-30, or ID-40 Reader, or on a MicroHAWK MV-20, MV-30, or MV-40 Smart Camera:

- Kit, Diffuser, MicroHAWK ID-20/MV-20 (98-9000077-01)
- Kit, Polarizer, MicroHAWK ID-20/MV-20 (98-9000062-01)
- Kit, Window Replacement, MicroHAWK ID-30 and ID-40/MV-30 and MV-40 (98-9000051-01)
- Kit, Red LEDs, MicroHAWK ID-30 and ID-40/MV-30 and MV-40 (98-9000045-01)
- Kit, White LEDs, MicroHAWK ID-30 and ID-40/MV-30 and MV-40 (98-9000046-01)

MicroHAWK ID-20/MV-20

Diffuser Kit Hardware, MicroHAWK ID-20/MV-20

Qty.	Description	Part Number
1	Kit, Diffuser, MicroHAWK ID-20/MV-20	98-9000077-01

Diffuser Kit Installation, MicroHAWK ID-20/MV-20

Step 1: Peel the protective liner from the adhesive on the diffuser.

Step 2: Rest the narrow edge of the diffuser on the bottom edge of the window opening at an angle as shown below.

Step 3: Center the diffuser left-to-right in the window opening.

Step 4: Affix the diffuser to the window.

Step 5: Run your finger over the surface of the diffuser using light pressure to complete the bond.

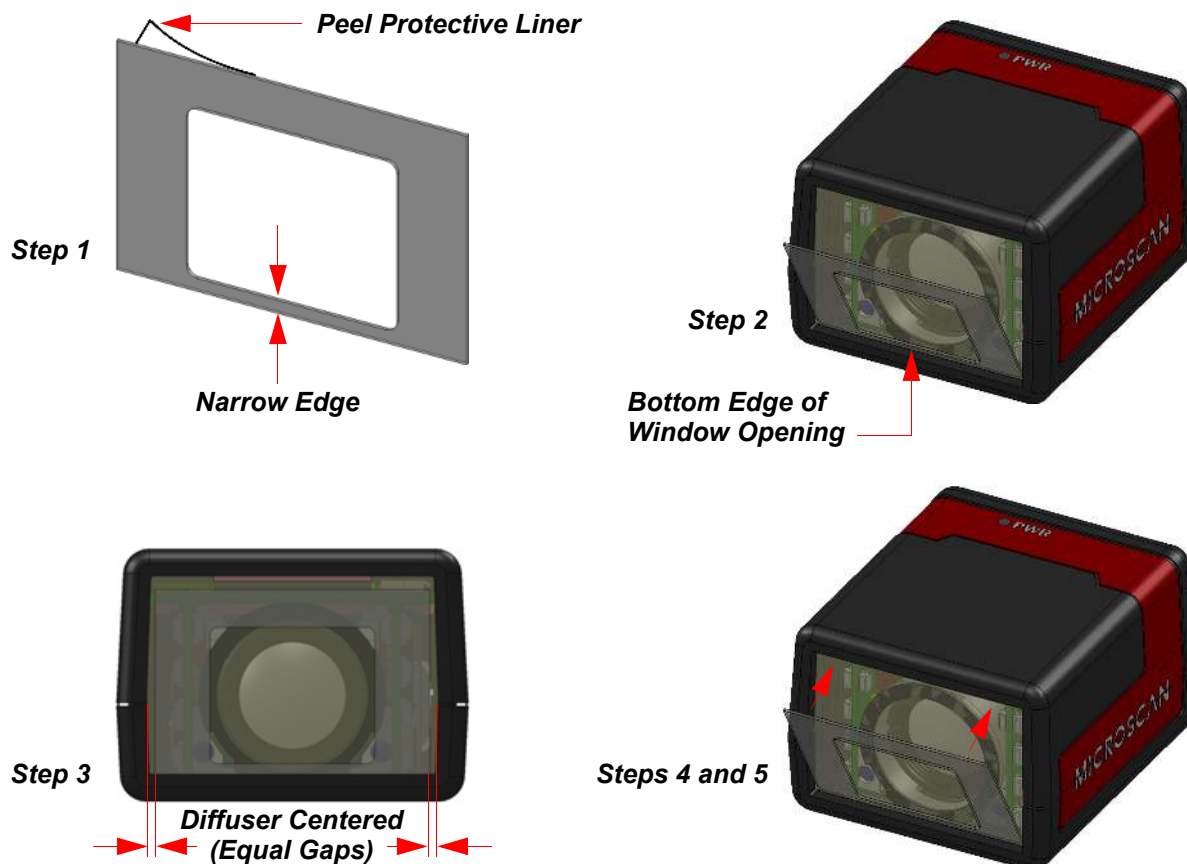

Polarizer Kit Hardware, MicroHAWK ID-20/MV-20

Qty.	Description	Part Number
1	Kit, Polarizer, MicroHAWK ID-20/MV-20	98-9000062-01

Polarizer Kit Installation, MicroHAWK ID-20/MV-20

Step 1: Peel the protective liner from adhesive on the polarizer.

Step 2: Rest the narrow edge of the polarizer on the bottom edge of the window opening at an angle as shown below.

Step 3: Center the polarizer left-to-right in the window opening.

Step 4: Affix the polarizer to the window.

Step 5: Run your finger over the surface of the polarizer using light pressure to complete the bond.

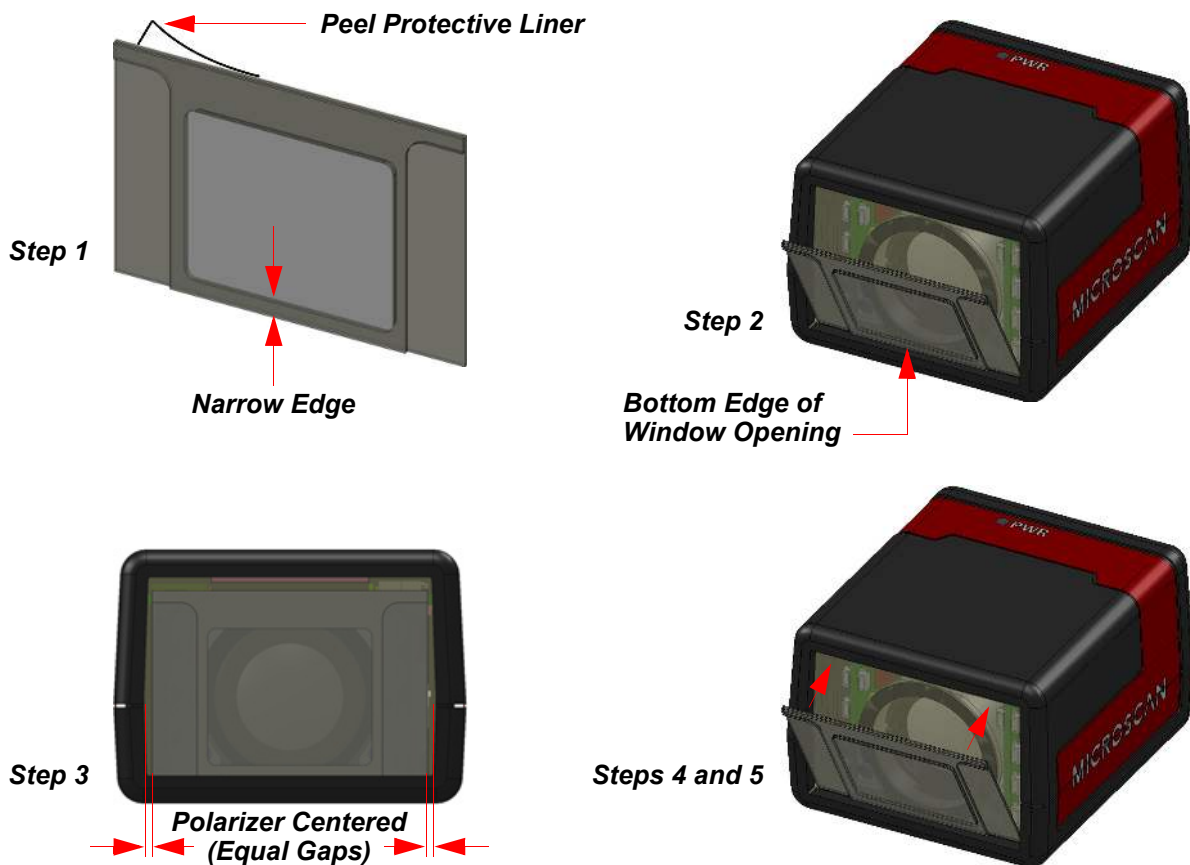

MicroHAWK ID-30/MV-30 and ID-40/MV-40

Window Replacement Kit Hardware, MicroHAWK ID-30/MV-30 and ID-40/MV-40

Qty.	Description	Part Number
1	Window or Window Accessory (included)	98-9000051-01
4	0-80 Phillips-Head Screws (included)	
1	Gasket (included)	
1	Phillips Torque Wrench (not included)	N/A

LED Kit Hardware, MicroHAWK ID-30/MV-30 and ID-40/MV-40

Qty.	Description	Part Number
2	LED Boards (included)	98-9000045-01 (Red)
6	0-80 Phillips-head Screws (included)	or
1	Gasket (included)	98-9000046-01 (White)
1	Phillips Torque Wrench (not included)	N/A
1	Fine-Tip Tweezers (not included)	

Window Removal, MicroHAWK ID-30/MV-30 and ID-40/MV-40

Step 1: Disconnect power from the reader.

Step 2: Remove the four screws from the front window of the reader.

Step 3: Remove the front window and gasket.

Note: If installing a window accessory only, skip to **Step 8**.

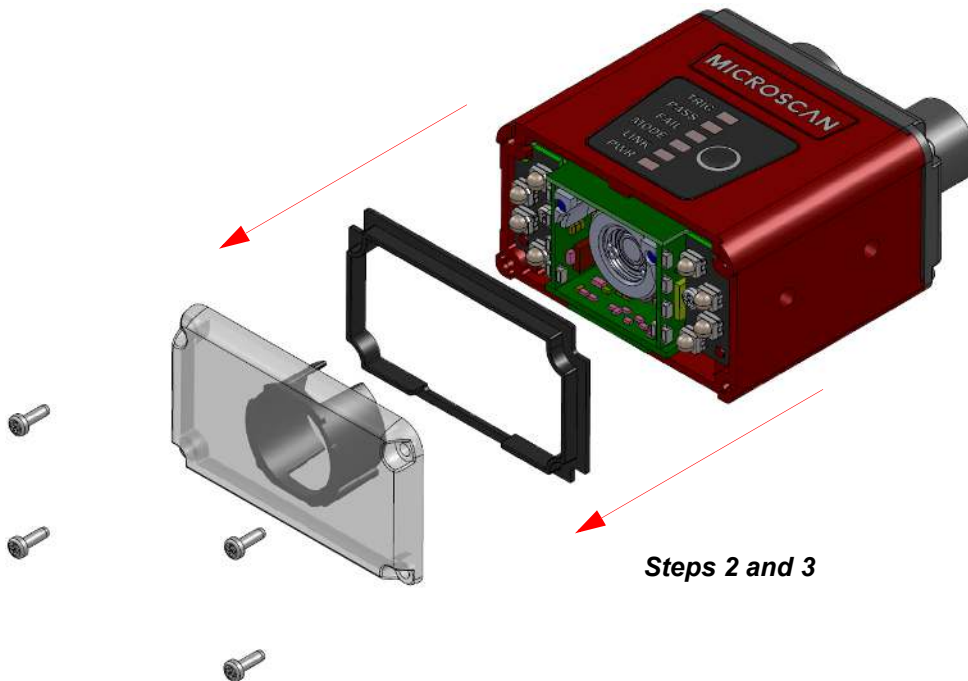

Outer LED Removal, MicroHAWK ID-30/MV-30 and ID-40/MV-40

Note: If installing an LED accessory only, skip to **Step 6**.

Step 4: Remove the two screws from the LED boards.

Step 5: Unplug the LED boards from the reader.

Note: The LED boards have a connector interface. Gently pry the top of each LED board from the main board using fine-tipped tweezers or an equivalent tool. Use caution not to contact the LEDs as they may become damaged.

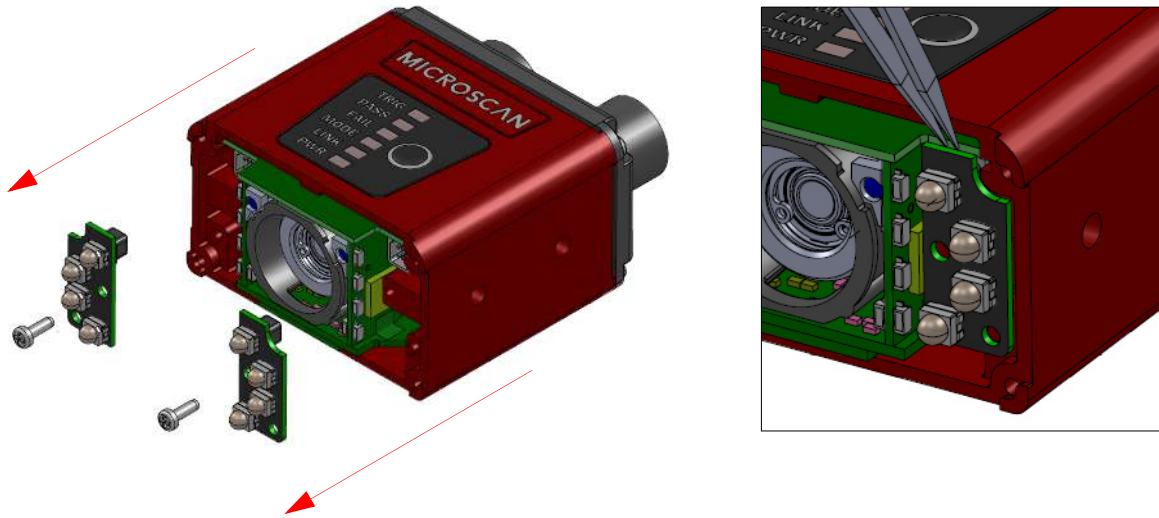

Steps 4 and 5

Outer LED Installation, MicroHAWK ID-30/MV-30 and ID-40/MV-40

Step 6: Plug the LED boards into the main board. Use caution not to touch the LEDs, as they may be damaged by contact.

Step 7: Secure the LED boards in place using the screws provided. Do not over-tighten the screws. (1.0 in./lbs. (0.11 nm max.)

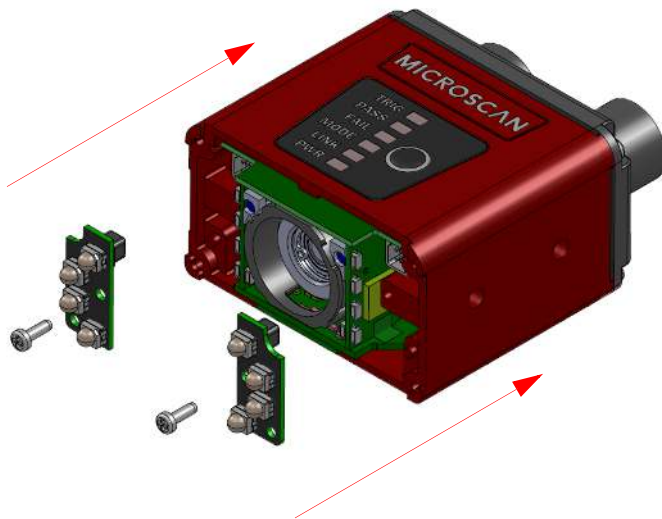

Steps 6 and 7

Window Installation, MicroHAWK ID-30/MV-30 and ID-40/MV-40

Step 8: Install the gasket onto the reader. Ensure that the gasket is properly seated in place and is covering all sealing surfaces.

Step 9: Install the window (or window accessory) onto the reader.

Step 10: Secure the window in place using the screws provided. Do not over-tighten the screws. (1.0 in./lbs. (0.11 nm max.)

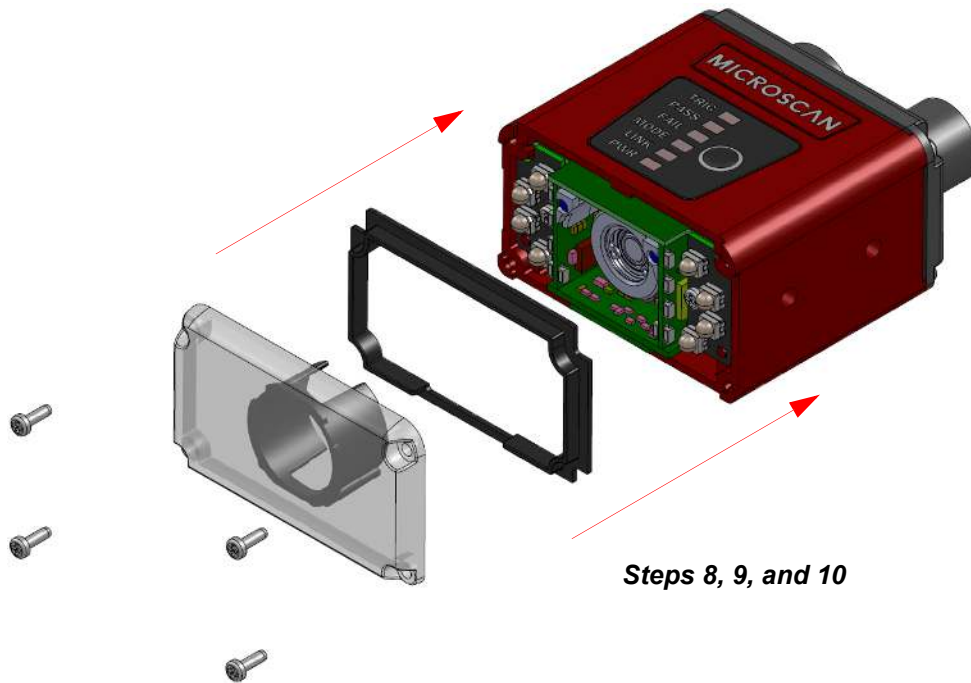

Steps 8, 9, and 10

MicroHAWK ID-45

Polarizer Kit Hardware, MicroHAWK ID-45

Qty.	Description	Part Number
1	Window Gasket (included)	98-9000220-01
1	Window Assembly (included)	
2	#2-56 X 3/8" Phillips Flat Head Screw (included)	
4	#4-40 X 1/4" Phillips Pan Head Screw w/ Lock Washers (included)	
1	Phillips Torque Driver (not included)	N/A

Step 1: Disconnect power from the reader.

Step 2: Unscrew the four #4-40 pan head screws that secure the window.

Step 3: Remove the gasket from around the window frame.

Step 4: Remove the two #2-56 flat head screws and diffuser.

Note: Do not touch the electronics or lens, as this may cause damage.

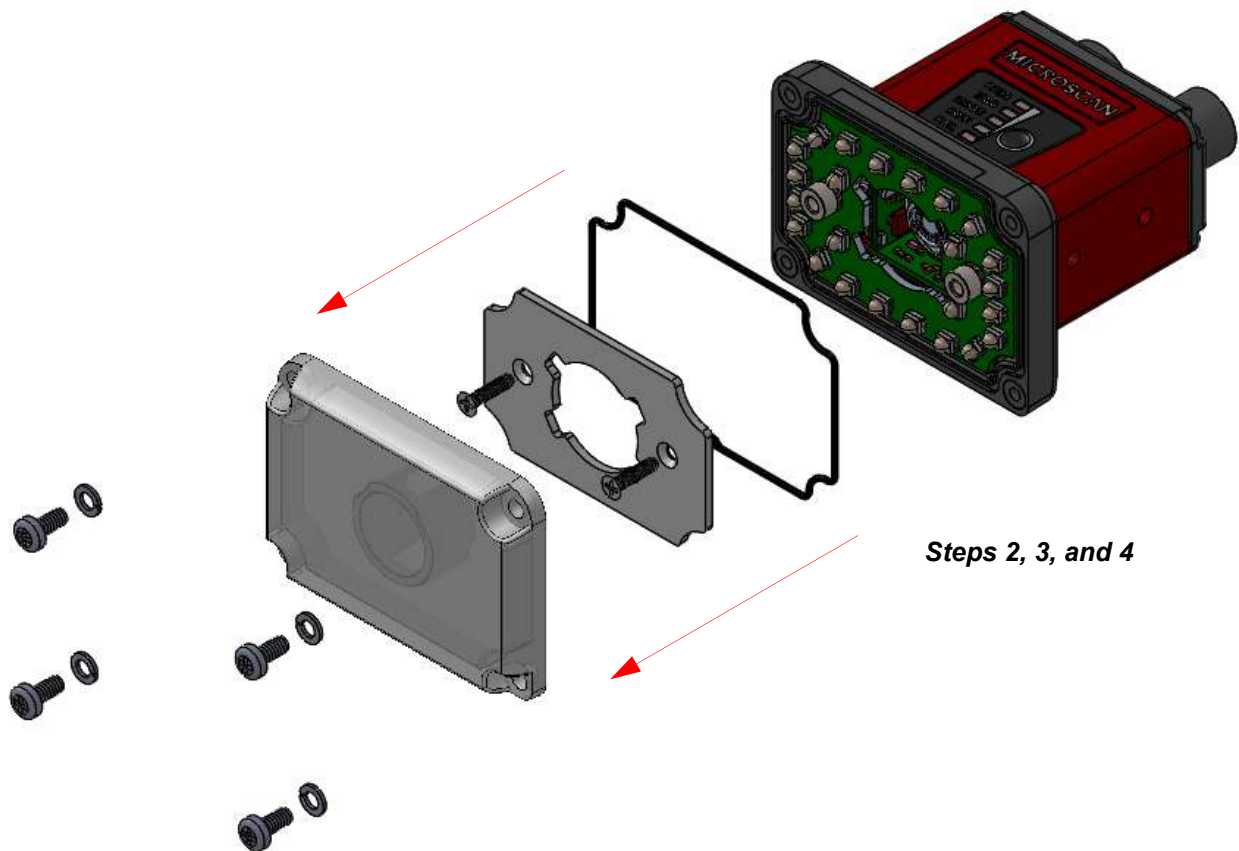

Step 5: Reinstall the new #2-56 flat head screws through the LED board PEM nuts. Do not overtighten the screws (1.9 in-lbs. (0.21 Nm) max)

Step 6: Install the new gasket, ensuring that it is fully constrained within the gasket groove.

Step 7: Place the polarizer window on the front of the unit and secure with the new #4-40 pan head screws and lock washers. Do not overtighten the screws (2.9 in-lbs. (0.33 Nm) max).

Step 8: Inspect the gasket to ensure it did not come out of the groove in the window frame.

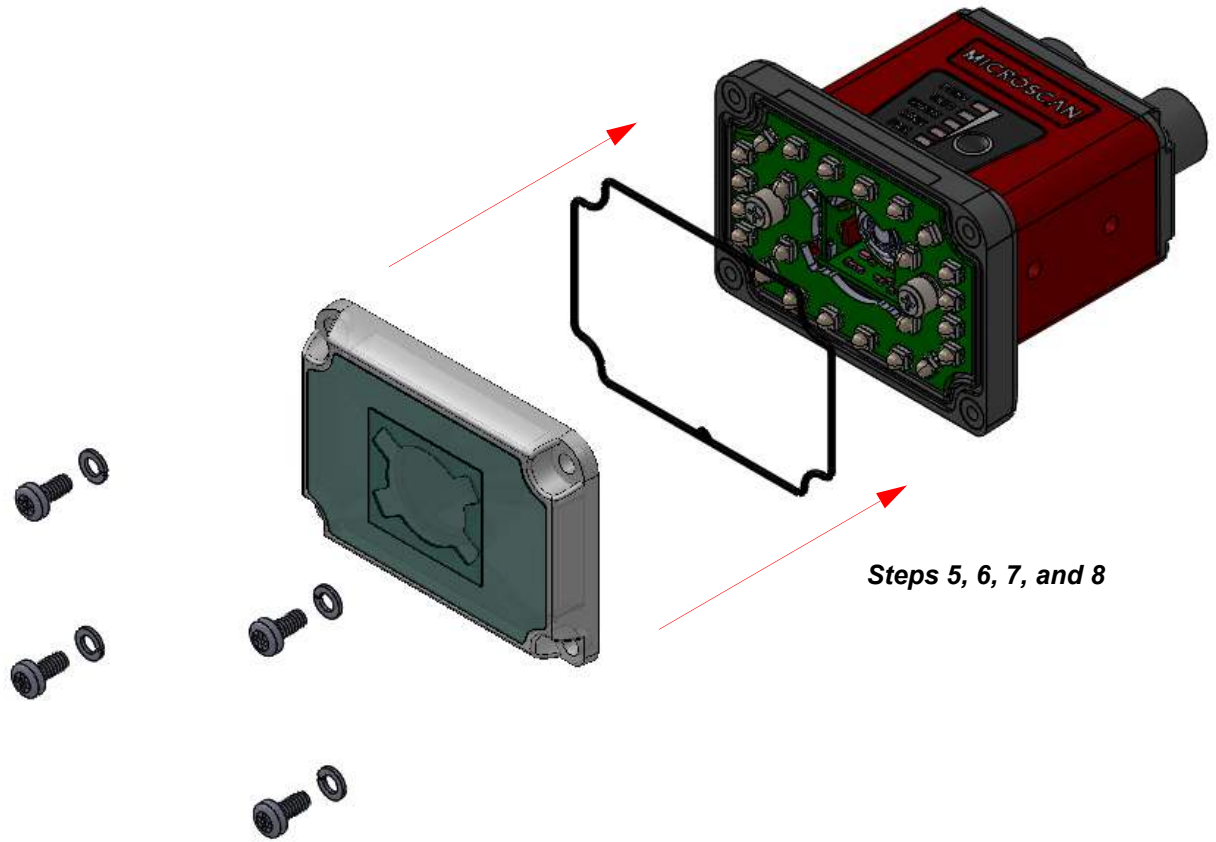

Steps 5, 6, 7, and 8



Reassembled MicroHAWK ID-45