

GlobTek, Inc. www.globtek.com 186 Veterans Drive, Northvale, NJ 07647 Tel. (201) 784-1000 Fax (201) 784-0111	Drawing Title: GTM96181-18PD-T2, USB Adaptive Power Source ICT/ITE/Medical Power supply, Efficiency Level: USA DOE Level VI / Eco-design Directive 2009/125/EC, (EU) 2019/1782, Case Color/Style: GlobTek Black, Desktop/External, USB Adaptive Power Supply AC Adaptor, Input Rating: 100-240V~, 50-60 Hz, IEC 60320/C8 , Output Rating: 18W, 5.0V, 5.8V, 9.0V, 12.0V, 15.0V, 15.1V, 20.0VV@3.0A, 3.0A, 2.0A, 1.5A, 1.2A, 1.19A, 0.9AA, Output Configuration: 1000 mm, 2C 20 + 3C 28/5C + Shield Cond, N/A, USB Type-C Connector, Shielded, Unibody, Rugged, Ferrite: None, GlobTek Black, GT Cord # C59970, Pin Out: A1, A12, B1, B12: COM A4, A9, B4, B9: V+ CC1:A5, D+ :A6 D- : A7, Blades/Input Cord: Not Applicable, Approvals: UKCA; Morocco;	
	Model No. GTM96181-18PD-T2	
	Part No./Ordering No. TR9KZ900USBCFG2R6B	Rev C2

In Addition to GlobTek Inc.'s renewed ISO9001:2015 - Quality Management System Certification, GlobTek Inc. is now certified to:

ISO13485:2016 - Medical Devices Quality Management System Certification

ISO14001:2015 - Environmental Management System Certification

ISO Certificates are available online at <https://www.globtek.com/iso-certificates/>

The acceptance of this specification and use of the product described in this document indicates the acceptance and binding of the customer to Globtek TERMS AND CONDITIONS (attached to the end of this document), which supersede all other agreements, terms, and conditions (<https://en.globtek.com/terms-and-conditions/>).

The purchaser of this product (Customer) agrees that it is their sole responsibility to determine suitability/fitness of the product described in this specification for their application and to take precautions for protection against any hazards attendant to the handling and use of the product.

Footnote:

GlobTek Inc. will not be liable for the safety and performance of these power supplies/battery packs if unauthorized access and repair occurs. End user should consult applicable UL, CSA or EN standards for proper installation instruction.

Limitation of Use:

GlobTek products are intended for use with commercial, medical, and/or industrial equipment only. GlobTek product are not authorized for use as mission critical components in life support hazardous environment, nuclear or aircraft applications without prior written approval from the CEO of GlobTek Inc.

Contents of this document are subject to change without prior notice.

### Customer Approval of Specification:

Please approve, sign and send back to GlobTek so we can complete order processing.

A delay in receipt of this form will delay delivery schedule.

Company Name: _____	Customer P/N: _____
Quote Number: _____	Date: _____
Authorized Representative Name: _____	Authorized Representative Signature: _____

<b>GlobTek, Inc.</b> www.globtek.com 186 Veterans Drive, Northvale, NJ 07647 Tel. (201) 784-1000 Fax (201) 784-0111	Drawing Title: GTM96181-18PD-T2, USB Adaptive Power Source ICT/ITE/Medical Power supply, Efficiency Level: USA DOE Level VI / Eco-design Directive 2009/125/EC, (EU) 2019/1782, Case Color/Style: GlobTek Black, Desktop/External, USB Adaptive Power Supply AC Adaptor, Input Rating: 100-240V~, 50-60 Hz, IEC 60320/C8 , Output Rating: 18W, 5.0V, 5.8V, 9.0V, 12.0V, 15.0V, 15.1V, 20.0VV@3.0A, 3.0A, 2.0A, 1.5A, 1.2A, 1.19A, 0.9AA, Output Configuration: 1000 mm, 2C 20 + 3C 28/5C + Shield Cond, N/A, USB Type-C Connector, Shielded, Unibody, Rugged, Ferrite: None, GlobTek Black, GT Cord # C59970, Pin Out: A1, A12, B1, B12: COM A4, A9, B4, B9: V+ CC1:A5, D+ :A6 D- : A7, Blades/Input Cord: Not Applicable, Approvals: UKCA; Morocco;	
	Model No. GTM96181-18PD-T2	
	Part No./Ordering No. TR9KZ900USBCFG2R6B	Rev C2

## REVISION HISTORY

REV	DESCRIPTION	SUB	DATE	APPROVED
C2	Update Firmware from GTF-7440-3 to GTF-7483-3	QA	04/05/2023	QA
C1	Add Firmware GTF-7440-3 to Power supply Information Update packing to 75 pcs, master carton dimensions to 455*430*320 mm, GW to 14.0 kg	QA	01/04/2022	QA
C	Add O/P cord for the unit	QA	07/09/2021	QA
B	Update Current out, update Advertised Power Data Objects (PDOs/APDOs)	QA	02/03/2021	QA
A	Initial release	DR	10/29/2020	DAVID

### POWER SUPPLY INFORMATION

TYPE	Desktop/External
TECHNOLOGY	USB Adaptive Power Supply AC Adaptor
FIRMWARE VER	GTF-7483-3
CASE COLOR	GlobTek Black
NAMEPLATE RATED INPUT	100-240V~, 50-60 Hz, 1.2A
INPUT CONFIG	IEC 60320/C8
WATTS	18.00
VOLTS OUT	5.0V, 5.8V, 9.0V, 12.0V, 15.0V, 15.1V, 20.0V
CURRENT OUT (Amps)	3.0A, 3.0A, 2.0A, 1.5A, 1.2A, 1.19A, 0.9A
BLADE/CORD INCLUDED	N/A Not Applicable
BLADE/CORD INSTALLED	N/A :Not Applicable
INGRESS PROTECTION	IP42
GROUNDING CONFIGURATION	(F1) Class II / Double Insulated
EFFICIENCY LEVEL	<a href="#">USA DOE Level VI</a> / <a href="#">Eco-design Directive 2009/125/EC, (EU) 2019/1782</a> - <a href="#">Europe Code of Conduct on Energy Efficiency of External Power Supplies - Version 5</a>
OUTPUT CONFIGURATION	1000 mm, 2C 20 + 3C 28/5C + Shield Cond, N/A, USB Type-C Connector, Shielded, Unibody, Rugged, Ferrite: None, GlobTek Black, GT Cord # C59970
OVERMOLDED	Yes
OUTPUT CONNECTOR GENDER	Male
CONNECTOR PIN OUT	A1, A12, B1, B12: COM A4, A9, B4, B9: V+ CC1:A5, D+ :A6 D- : A7
LABEL SPECS	ISO 15223 medical device compliant label,L-1470
SPECIAL BARCODE LABEL MATERIAL	No
PACK SPEC	Standard, Cellular packaging
USER MANUAL	

#### PROPRIETARY INFORMATION

<p>GlobTek, Inc.  www.globtek.com  186 Veterans Drive,  Northvale, NJ 07647  Tel. (201) 784-1000  Fax (201) 784-0111</p>	<p>Drawing Title: GTM96181-18PD-T2, USB Adaptive Power Source ICT/ITE/Medical Power supply, Efficiency Level: USA DOE Level VI / Eco-design Directive 2009/125/EC, (EU) 2019/1782, Case Color/Style: GlobTek Black, Desktop/External, USB Adaptive Power Supply AC Adaptor, Input Rating: 100-240V~, 50-60 Hz, IEC 60320/C8 , Output Rating: 18W, 5.0V, 5.8V, 9.0V, 12.0V, 15.0V, 15.1V, 20.0VV@3.0A, 3.0A, 2.0A, 1.5A, 1.2A, 1.19A, 0.9AA, Output Configuration: 1000 mm, 2C 20 + 3C 28/5C + Shield Cond, N/A, USB Type-C Connector, Shielded, Unibody, Rugged, Ferrite: None, GlobTek Black, GT Cord # C59970, Pin Out: A1, A12, B1, B12: COM A4, A9, B4, B9: V+ CC1:A5, D+ :A6 D- : A7, Blades/Input Cord: Not Applicable, Approvals: UKCA; Morocco;</p>
	<p>Model No. GTM96181-18PD-T2</p>
	<p>Part No./Ordering No. TR9KZ900USBCFG2R6B</p>
	<p>Rev C2</p>

Notes/Modifications/Customizations (notes in this section supersede the values shown in the standard spec)  
DIMENSIONS ARE IN MM UNLESS SPECIFIED OTHERWISE

GloTek, Inc. www.globtek.com 186 Veterans Drive, Northvale, NJ 07647 Tel. (201) 784-1000 Fax (201) 784-0111	Drawing Title: GTM96181-18PD-T2, USB Adaptive Power Source ICT/ITE/Medical Power supply, Efficiency Level: USA DOE Level VI / Eco-design Directive 2009/125/EC, (EU) 2019/1782, Case Color/Style: GlobTek Black, Desktop/External, USB Adaptive Power Supply AC Adaptor, Input Rating: 100-240V~, 50-60 Hz, IEC 60320/C8 , Output Rating: 18W, 5.0V, 5.8V, 9.0V, 12.0V, 15.0V, 15.1V, 20.0VV@3.0A, 3.0A, 2.0A, 1.5A, 1.2A, 1.19A, 0.9AA, Output Configuration: 1000 mm, 2C 20 + 3C 28/5C + Shield Cond, N/A, USB Type-C Connector, Shielded, Unibody, Rugged, Ferrite: None, GlobTek Black, GT Cord # C59970, Pin Out: A1, A12, B1, B12: COM A4, A9, B4, B9: V+ CC1:A5, D+ :A6 D- : A7, Blades/Input Cord: Not Applicable, Approvals: UKCA; Morocco;	
	Model No. GTM96181-18PD-T2	
	Part No./Ordering No. TR9KZ900USBCFG2R6B	Rev C2

## ELECTRICAL SPECIFICATIONS

### USB Power Delivery Capabilities

Protocol supported:	USB Power Delivery (PD) 2.0/3.0 + PPS
Advertised Power Data Objects (PDOs/APDOs):	Standard option: 5V, 5.8V, 9V, 12V, 15V, 15.1V, 20V PPS option (18W): 5V, 9V, 12V, 15V, 15.1V, 20V, PPS (5-21V) PPS option (36W): 5V, 9V, 15V, 20V, PPS (5-11V), PPS (5-16V), PPS (5-21V)
Note 1:	Custom fixed PDOs available upon request. PDO1 must be 5V. PDO2 through PDO7 may be set to any custom voltage from 5V to 20V, with a step size of 100mV.
Note 2:	In critical applications, the use of a non-authorized USB PD power supply may pose a substantial risk. Power supply authorization may be implemented using USB PD Vendor Defined Messages (VDMs) to prevent system operation with non-authorized power sources. Please see our article <a href="#">Product Security and Risk Mitigation for USB Power Delivery (PD) Based Systems</a> for additional information.

### Input

Input Voltage:	Specified: 90-264VAC, Nameplate: 100-240VAC 100% rated load current for 90-264VAC 85% rated load current for 85-264VAC 100% rated load current for 110-370VDC
Input Frequency:	Specified: 47-63Hz, Nameplate: 50-60Hz
No Load Input Power:	< 75mW @ 230VAC (EU CoC Tier 2 compliant)
Inrush Current:	< 30A @ 115VAC, < 60A @ 230VAC (cold start)
Efficiency:	DoE Efficiency Level VI and CoC Tier 2 compliant (tested according to DoE 10 CFR Part 430, Subpart B, Appendix Z)

### Output

Turn-on Delay:	< 1 second @ 115VAC and full load
Output Regulation	± 4% max. (measured at the end of a 1m long output cord)
Line Regulation:	± 0.5% typ. (measured at the end of a 1m long output cord)
Ripple:	100mV max. (using a 47µF low-ESR electrolytic cap + 0.1µF ceramic cap, measured @ 20MHz BW, at the output connector)
Transient Response:	5% max. deviation, 1ms max. recovery time (with 25% load step),
Hold-up Time:	8ms min. (100VAC and full load)
Power Indicator:	Green LED

### Protections

Input Protection:	MOV transient suppressor, input line fusing
-------------------	---

#### PROPRIETARY INFORMATION

PROPRIETARY OF GLOBTEK, INC. ANY REPRODUCTION, DISCLOSURE OR USE OF THIS DRAWING, IN WHOLE OR IN PART, IS HEREBY PROHIBITED EXCEPT AS SPECIFIED IN WRITING BY GLOBTEK, INC. © GlobTek, Inc. 2020 - 2023

<b>GlobTek, Inc.</b> www.globtek.com 186 Veterans Drive, Northvale, NJ 07647 Tel. (201) 784-1000 Fax (201) 784-0111	Drawing Title: GTM96181-18PD-T2, USB Adaptive Power Source ICT/ITE/Medical Power supply, Efficiency Level: USA DOE Level VI / Eco-design Directive 2009/125/EC, (EU) 2019/1782, Case Color/Style: GlobTek Black, Desktop/External, USB Adaptive Power Supply AC Adaptor, Input Rating: 100-240V~, 50-60 Hz, IEC 60320/C8 , Output Rating: 18W, 5.0V, 5.8V, 9.0V, 12.0V, 15.0V, 15.1V, 20.0VV@3.0A, 3.0A, 2.0A, 1.5A, 1.2A, 1.19A, 0.9AA, Output Configuration: 1000 mm, 2C 20 + 3C 28/5C + Shield Cond, N/A, USB Type-C Connector, Shielded, Unibody, Rugged, Ferrite: None, GlobTek Black, GT Cord # C59970, Pin Out: A1, A12, B1, B12: COM A4, A9, B4, B9: V+ CC1:A5, D+ :A6 D- : A7, Blades/Input Cord: Not Applicable, Approvals: UKCA; Morocco;	
	Model No. GTM96181-18PD-T2	
	Part No./Ordering No. TR9KZ900USBCFG2R6B	Rev C2

Over-Voltage Protection:	Level 1: 110-130%, Auto-recovery, adaptive to selected PDO Level 2: 24-28V, Latched off, cycle AC to reset
Over-Current Protection:	110-130%, Auto-recovery, adaptive to selected PDO
Short-Circuit Protection:	Auto-recovery
Over-Temperature Protection:	Auto-recovery

## Environmental

MTBF:	1,500,000 hours @ 25°C ambient, full load (Telcordia SR-332, Issue 3)
Operating Temperature:	-10°C to 40°C (full load)
Storage Temperature:	-40°C to 80°C
Humidity:	0% to 95% relative humidity, non-condensing
Altitude	5000m
Cooling:	Convection
RoHS:	Complies with EU 2011/65/EU and China SJ/T 11363-2006

## Safety

Dielectric Withstand Voltage:	4000VAC or 5656VDC from input to output 10mA, 1 minute
Touch Current:	NC: 80µA max. SFC: 400µA max.
Earth Leakage Current	300µA max. NC/SFC (N/A for 2-conductor input models)
Means of Protection:	2 x MOPP
Output Isolation Options:	-Q suffix: Class II 2-conductor (interchangeable blades) -T2 suffix: Class II 2-conductor -T3 suffix: Class II, with functional earth (FE) Class I, earth wire connected directly to output negative
Note 3:	Review output isolation options with our article: <a href="#">PSU Isolation and Identify</a>

## EMC

Applicable Standards:	Medical: EN 60601-1-2 (4e) Emissions: EN55032, EN61000-6-3, EN61000-6-4 Immunity: EN55024, EN61000-6-1 (4e), EN61000-6-2 (4e)
Conducted Emissions:	Class B, FCC Part 15, Class B (with resistive load)
Radiated Emissions:	Class B, FCC Part 15, Class B (with resistive load)
Harmonic Current Voltage Distortion:	EN61000-3-2, Class A
Voltage Fluctuations/Flicker:	EN61000-3-3
Electrostatic Discharge (ESD) Immunity:	EN61000-4-2, 10KV contact discharge, 18KV air discharge, Criterion A
Radiated RF Immunity:	EN61000-4-3, 10V/m @ 80-1000MHz, 3V/m @ 1-2.7GHz, 80% 1KHz AM, Criterion A
EFT/Burst Immunity:	EN61000-4-4, 4KV/100KHz., Criterion A

### PROPRIETARY INFORMATION

PROPRIETARY OF GLOBTEK, INC. ANY REPRODUCTION, DISCLOSURE OR USE OF THIS DRAWING, IN WHOLE OR IN PART, IS HEREBY PROHIBITED EXCEPT AS SPECIFIED IN WRITING BY GLOBTEK, INC. © GlobTek, Inc. 2020 - 2023

<b>GlobTek, Inc.</b> www.globtek.com 186 Veterans Drive, Northvale, NJ 07647 Tel. (201) 784-1000 Fax (201) 784-0111	Drawing Title: GTM96181-18PD-T2, USB Adaptive Power Source ICT/ITE/Medical Power supply, Efficiency Level: USA DOE Level VI / Eco-design Directive 2009/125/EC, (EU) 2019/1782, Case Color/Style: GlobTek Black, Desktop/External, USB Adaptive Power Supply AC Adaptor, Input Rating: 100-240V~, 50-60 Hz, IEC 60320/C8 , Output Rating: 18W, 5.0V, 5.8V, 9.0V, 12.0V, 15.0V, 15.1V, 20.0VV@3.0A, 3.0A, 2.0A, 1.5A, 1.2A, 1.19A, 0.9AA, Output Configuration: 1000 mm, 2C 20 + 3C 28/5C + Shield Cond, N/A, USB Type-C Connector, Shielded, Unibody, Rugged, Ferrite: None, GlobTek Black, GT Cord # C59970, Pin Out: A1, A12, B1, B12: COM A4, A9, B4, B9: V+ CC1:A5, D+ :A6 D- : A7, Blades/Input Cord: Not Applicable, Approvals: UKCA; Morocco;	
	Model No. GTM96181-18PD-T2	
	Part No./Ordering No. TR9KZ900USBCFG2R6B	Rev C2

Line Surge Immunity:	EN61000-4-5, 2KV differential, 4KV common-mode, Criterion A
Conducted RF Immunity:	EN61000-4-6, 10VRMS, 80% 1KHz AM, Criterion A
Voltage Dip Immunity:	EN61000-4-11, Criterion B/C
Note 4:	When a Class II power supply is connected to an earth-referenced system, conducted/radiated EMI levels tend to increase since the distant earth connection creates a long return path for common-mode EMI currents. This model includes an output common-mode choke to help alleviate system-level EMI issues. This choke can be removed for cost-sensitive applications.

## Enclosure

Housing:	High impact plastic, 94V0 polycarbonate, non-vented
Markings:	Adhesive backed label or laser engraving

## Security

USB Power Delivery:	Two non-standard voltage profiles are included: 5.8V and 15.1V. System designers may use these non-standard profiles to reduce the likelihood of system operation with non-GlobTek power supplies. 12.0V is also not standard, but is often included in other power supplies.
Note 5:	The power supply will respond to a USB PD "Discover Identity" VDM with 0x4754 in the "ProductID" field. USB PD host systems may check this value before initiating/allowing power negotiation. These measures do not guarantee a secure implementation, and are only suggested as a method of risk mitigation.
Note 6:	Please see our article <a href="#">Product Security and Risk Mitigation for USB Power Delivery (PD) Based Systems</a> for additional information.

## Special Options

Non-standard - Contact GlobTek

1. Custom housing and output cord colors
2. Custom fixed output cord length, for applicable models (1m, 2m, 3m lengths)
3. Custom markings and marking methods
4. Custom USB PD PDOs: Output voltages selectable between 5V and 20V, in 100mV increments

TO ADDRESS SYSTEM-LEVEL EMI CONCERNS, FERRITE CHOKES/BEADS MAY BE ADDED/REVISED UPON REQUEST. A SAMPLE KIT OF GLOBTEK'S STANDARD FERRITES IS AVAILABLE UNDER GLOBTEK P/N: EMI-MITIGATION-KIT1

FOR ADDITIONAL INFORMATION, PLEASE READ OUR WHITE PAPER AT: <https://r.globtek.info/3QeaqtD>

INGRESS PROTECTION: IP42

<p>GlobTek, Inc.  www.globtek.com  186 Veterans Drive,  Northvale, NJ 07647  Tel. (201) 784-1000  Fax (201) 784-0111</p>	<p>Drawing Title: GTM96181-18PD-T2, USB Adaptive Power Source ICT/ITE/Medical Power supply, Efficiency Level: USA DOE Level VI / Eco-design Directive 2009/125/EC, (EU) 2019/1782, Case Color/Style: GlobTek Black, Desktop/External, USB Adaptive Power Supply AC Adaptor, Input Rating: 100-240V~, 50-60 Hz, IEC 60320/C8 , Output Rating: 18W, 5.0V, 5.8V, 9.0V, 12.0V, 15.0V, 15.1V, 20.0VV@3.0A, 3.0A, 2.0A, 1.5A, 1.2A, 1.19A, 0.9AA, Output Configuration: 1000 mm, 2C 20 + 3C 28/5C + Shield Cond, N/A, USB Type-C Connector, Shielded, Unibody, Rugged, Ferrite: None, GlobTek Black, GT Cord # C59970, Pin Out: A1, A12, B1, B12: COM A4, A9, B4, B9: V+ CC1:A5, D+ :A6 D- : A7, Blades/Input Cord: Not Applicable, Approvals: UKCA; Morocco;</p> <p>Model No. GTM96181-18PD-T2</p> <p>Part No./Ordering No. TR9KZ900USBCFG2R6B</p>	<p>Rev C2</p>
--	---	---------------

3D File Download <https://www.globtek.com/file/dl/gtm96181-wwpd-t2.stp>

Mechanical drawing

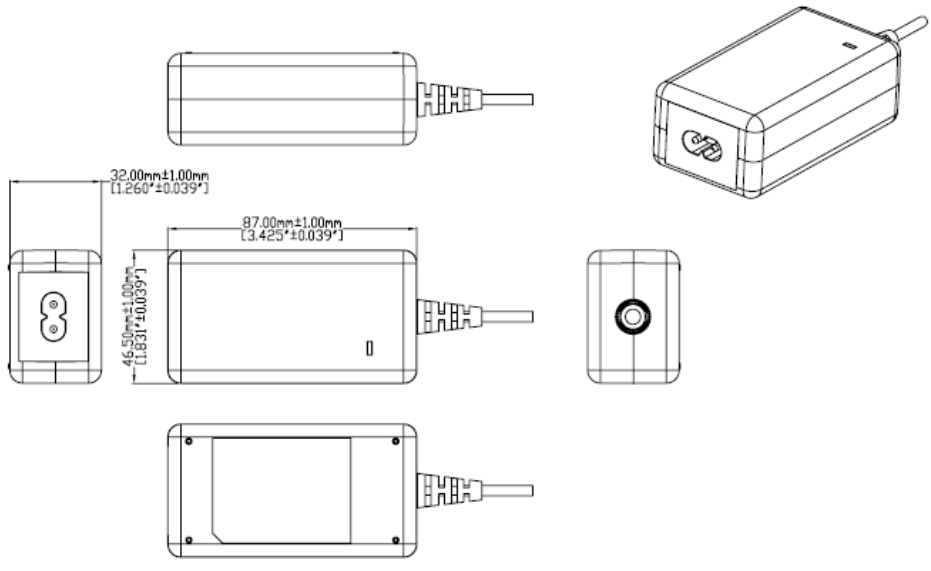

<p>GlobTek, Inc.  www.globtek.com  186 Veterans Drive,  Northvale, NJ 07647  Tel. (201) 784-1000  Fax (201) 784-0111</p>	<p>Drawing Title: GTM96181-18PD-T2, USB Adaptive Power Source ICT/ITE/Medical Power supply, Efficiency Level: USA DOE Level VI / Eco-design Directive 2009/125/EC, (EU) 2019/1782, Case Color/Style: GlobTek Black, Desktop/External, USB Adaptive Power Supply AC Adaptor, Input Rating: 100-240V~, 50-60 Hz, IEC 60320/C8 , Output Rating: 18W, 5.0V, 5.8V, 9.0V, 12.0V, 15.0V, 15.1V, 20.0VV@3.0A, 3.0A, 2.0A, 1.5A, 1.2A, 1.19A, 0.9AA, Output Configuration: 1000 mm, 2C 20 + 3C 28/5C + Shield Cond, N/A, USB Type-C Connector, Shielded, Unibody, Rugged, Ferrite: None, GlobTek Black, GT Cord # C59970, Pin Out: A1, A12, B1, B12: COM A4, A9, B4, B9: V+ CC1:A5, D+ :A6 D- : A7, Blades/Input Cord: Not Applicable, Approvals: UKCA; Morocco;</p> <p>Model No. GTM96181-18PD-T2</p> <p>Part No./Ordering No. TR9KZ900USBCFG2R6B</p>	<p>Rev C2</p>
--	---	---------------

DERATING CURVE

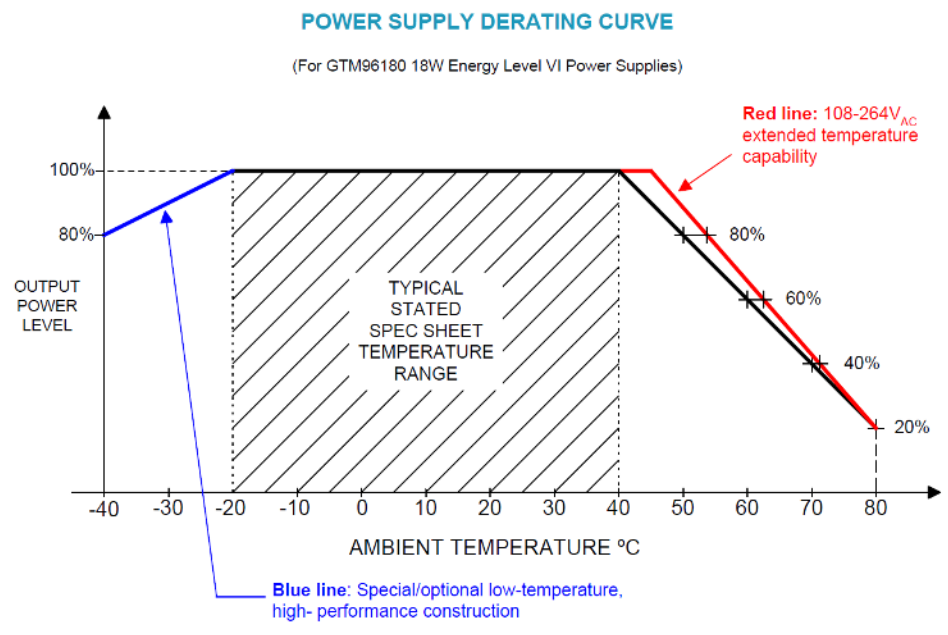



GloTek, Inc. www.globtek.com 186 Veterans Drive, Northvale, NJ 07647 Tel. (201) 784-1000 Fax (201) 784-0111	Drawing Title: GTM96181-18PD-T2, USB Adaptive Power Source ICT/ITE/Medical Power supply, Efficiency Level: USA DOE Level VI / Eco-design Directive 2009/125/EC, (EU) 2019/1782, Case Color/Style: GlobTek Black, Desktop/External, USB Adaptive Power Supply AC Adaptor, Input Rating: 100-240V~, 50-60 Hz, IEC 60320/C8 , Output Rating: 18W, 5.0V, 5.8V, 9.0V, 12.0V, 15.0V, 15.1V, 20.0VV@3.0A, 3.0A, 2.0A, 1.5A, 1.2A, 1.19A, 0.9AA, Output Configuration: 1000 mm, 2C 20 + 3C 28/5C + Shield Cond, N/A, USB Type-C Connector, Shielded, Unibody, Rugged, Ferrite: None, GlobTek Black, GT Cord # C59970, Pin Out: A1, A12, B1, B12: COM A4, A9, B4, B9: V+ CC1:A5, D+ :A6 D- : A7, Blades/Input Cord: Not Applicable, Approvals: UKCA; Morocco;	
	Model No. GTM96181-18PD-T2	
	Part No./Ordering No. TR9KZ900USBCFG2R6B	Rev C2

### INPUT CONFIGURATION

(F1) Class II / Double Insulated



[Alternate grounding configurations](#) available upon request.

Blades/Cord Included:N/A:Not Applicable

Blades/Cord Installed:N/A:Not Applicable

IEC 60320/C8 AC Inlet connector, Class II, Non-Earth Ground (aka "Figure-8")

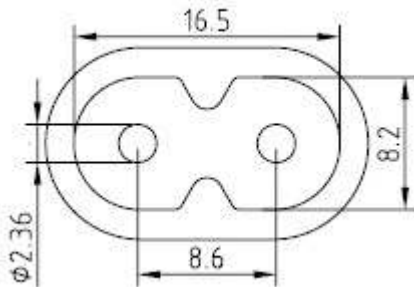

Mates with IEC 60320/C7 Plug

Below are standard cordsets which are "not included" (unless stated above); these may be purchased separately or packaged with the power supply. Please contact your Sales Engineer if the style required is not shown below. Many more available in different lengths, colors or cable material.

#### [Standard International IEC 320/C7 Cordsets](#)

Part Number	Type	Standard	Connector	Length (mm)	Length (feet)
<a href="#">2094112M703(R)</a>	Argentina (Type I)	IRAM 2063	IEC 320/C7	2000	7
<a href="#">5014112M703A(R)</a>	Australian (Type I)	AS 3112	IEC 320/C7	2000	7
<a href="#">207B4111M8703(R)</a>	Brazil (Type N)	NBR14136	IEC 320/C7	1800	6
<a href="#">4533501M8703(R)</a>	China (Type A)	GB 2099.1	IEC 320/C7	1830	6
<a href="#">2074112M703A(R)</a>	European (Type C)	CEE 7/16	IEC 320/C7	2000	7
<a href="#">2074112M703AEUSA(R)</a>	European/South Africa Combo(Type C)	CEE 7/16	IEC 320/C7	2000	7
<a href="#">2084111M8703B(R)</a>	India (Type D)	IS 1293	IEC 320/C7	1800	6

#### PROPRIETARY INFORMATION

PROPRIETARY OF GLOBTEK, INC. ANY REPRODUCTION, DISCLOSURE OR USE OF THIS DRAWING, IN WHOLE OR IN PART, IS HEREBY PROHIBITED EXCEPT AS SPECIFIED IN

WRITING BY GLOBTEK, INC. © GlobTek, Inc. 2020 - 2023

quest / 07/31/2023 7:06:32 PM GMT CLONED FROM WR9QZ900USBCFG2R6B

<p>GlobTek, Inc. www.globtek.com 186 Veterans Drive, Northvale, NJ 07647 Tel. (201) 784-1000 Fax (201) 784-0111</p>	<p>Drawing Title: GTM96181-18PD-T2, USB Adaptive Power Source ICT/ITE/Medical Power supply, Efficiency Level: USA DOE Level VI / Eco-design Directive 2009/125/EC, (EU) 2019/1782, Case Color/Style: GlobTek Black, Desktop/External, USB Adaptive Power Supply AC Adaptor, Input Rating: 100-240V~, 50-60 Hz, IEC 60320/C8 , Output Rating: 18W, 5.0V, 5.8V, 9.0V, 12.0V, 15.0V, 15.1V, 20.0VV@3.0A, 3.0A, 2.0A, 1.5A, 1.2A, 1.19A, 0.9AA, Output Configuration: 1000 mm, 2C 20 + 3C 28/5C + Shield Cond, N/A, USB Type-C Connector, Shielded, Unibody, Rugged, Ferrite: None, GlobTek Black, GT Cord # C59970, Pin Out: A1, A12, B1, B12: COM A4, A9, B4, B9: V+ CC1:A5, D+ :A6 D- : A7, Blades/Input Cord: Not Applicable, Approvals: UKCA; Morocco;</p>	
	<p>Model No. GTM96181-18PD-T2</p>	
	<p>Part No./Ordering No. TR9KZ900USBCFG2R6B</p>	<p>Rev C2</p>

<a href="#">451J3401M8703(R)</a>	Japan (Type A)	JIS 8303	IEC 320/C7	1830	6
<a href="#">2044112M703A(R)</a>	Korea (Type C)	KS C8305	IEC 320/C7	2000	7
<a href="#">4511116F703A(R)</a>	North America (Type A)	NEMA 1-15P	IEC 320/C7	1830	6
<a href="#">2084111M8703(R)</a>	South Africa (Type M)	BS 546	IEC320/C7	1830	6
<a href="#">4033401M8703A(R)</a>	Taiwan (Type A)	CNS690	IEC 320/C7	1830	6
<a href="#">6104112M703A(R)</a>	UK, Hong Kong, Singapore, Gulf States (Type G)	BS1363	IEC 320/C7	2000	7
<a href="#">451G1116F703A(R)</a>	Gulf States (Kuwait, Bahrain, Oman, Qatar, Saudi Arabia, Yemen and the United Arab Emirates (UAE))(Type A)	Nema 1-15P	IEC320/C7	1830	6
<a href="#">6303742M5703(R)</a>	Thailand (Type C)	TIS 166-2549	IEC320/C7	2500	8

GlobTek, Inc. www.globtek.com 186 Veterans Drive, Northvale, NJ 07647 Tel. (201) 784-1000 Fax (201) 784-0111	Drawing Title: GTM96181-18PD-T2, USB Adaptive Power Source ICT/ITE/Medical Power supply, Efficiency Level: USA DOE Level VI / Eco-design Directive 2009/125/EC, (EU) 2019/1782, Case Color/Style: GlobTek Black, Desktop/External, USB Adaptive Power Supply AC Adaptor, Input Rating: 100-240V~, 50-60 Hz, IEC 60320/C8 , Output Rating: 18W, 5.0V, 5.8V, 9.0V, 12.0V, 15.0V, 15.1V, 20.0VV@3.0A, 3.0A, 2.0A, 1.5A, 1.2A, 1.19A, 0.9AA, Output Configuration: 1000 mm, 2C 20 + 3C 28/5C + Shield Cond, N/A, USB Type-C Connector, Shielded, Unibody, Rugged, Ferrite: None, GlobTek Black, GT Cord # C59970, Pin Out: A1, A12, B1, B12: COM A4, A9, B4, B9: V+ CC1:A5, D+ :A6 D- : A7, Blades/Input Cord: Not Applicable, Approvals: UKCA; Morocco;	
	Model No. GTM96181-18PD-T2	
	Part No./Ordering No. TR9KZ900USBCFG2R6B	Rev C2

**OUTPUT CORD AND CONNECTOR: USB00016/C59970**

ACTUAL CONNECTORS, OVERMOLDS, FERRITES MAY VARY SLIGHTLY FROM THE PICTURE BELOW

CABLE TYPE	N/A
CABLE LENGTH (mm)	1000
CABLE TOLERANCE (mm)	±50
WIRE GAUGE (AWG)	2C 20 + 3C 28
CONDUCTORS	5C + Shield
HANK DIMENSION (mm)	80+/-20
CABLE / CONNECTOR OVERMOLD COLOR	GlobTek Black
FERRITE TYPE AND DIMENSION	None
FERRITE NUMBER OF TURNS <a href="#">(Definition)</a>	N/A
FERRITE DIMENSION FROM STRAIN RELIEF	N/A
FERRITE DIMENSION FROM PLUG	N/A
PLUG TYPE	USB Type-C Connector, Shielded, Unibody, Rugged
OUTPUT CONNECTOR GENDER	Male
OVERMOLDED	Yes
OVER MOLD ORIENTATION	Straight
CONNECTOR PIN OUT	A1, A12, B1, B12: COM A4, A9, B4, B9: V+ CC1:A5, D+ :A6 D- : A7

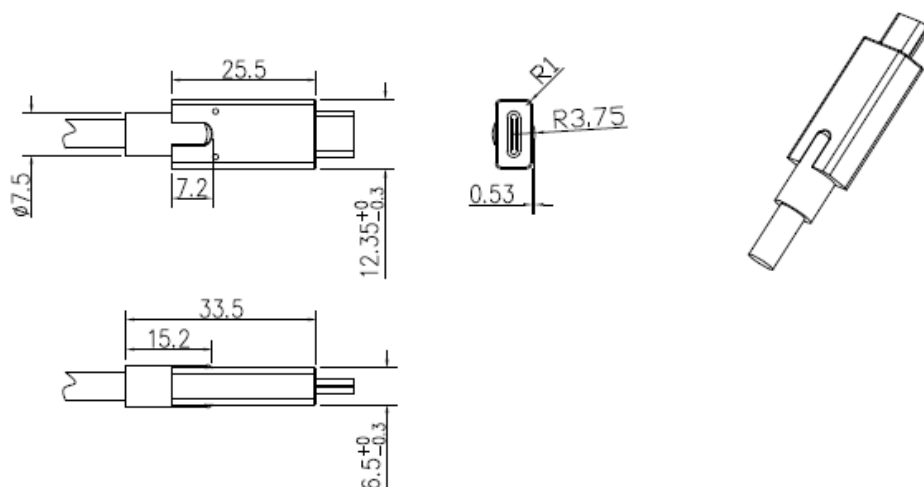

<p>GlobTek, Inc. www.globtek.com 186 Veterans Drive, Northvale, NJ 07647 Tel. (201) 784-1000 Fax (201) 784-0111</p>	<p>Drawing Title: GTM96181-18PD-T2, USB Adaptive Power Source ICT/ITE/Medical Power supply, Efficiency Level: USA DOE Level VI / Eco-design Directive 2009/125/EC, (EU) 2019/1782, Case Color/Style: GlobTek Black, Desktop/External, USB Adaptive Power Supply AC Adaptor, Input Rating: 100-240V~, 50-60 Hz, IEC 60320/C8 , Output Rating: 18W, 5.0V, 5.8V, 9.0V, 12.0V, 15.0V, 15.1V, 20.0VV@3.0A, 3.0A, 2.0A, 1.5A, 1.2A, 1.19A, 0.9AA, Output Configuration: 1000 mm, 2C 20 + 3C 28/5C + Shield Cond, N/A, USB Type-C Connector, Shielded, Unibody, Rugged, Ferrite: None, GlobTek Black, GT Cord # C59970, Pin Out: A1, A12, B1, B12: COM A4, A9, B4, B9: V+ CC1:A5, D+ :A6 D- : A7, Blades/Input Cord: Not Applicable, Approvals: UKCA; Morocco;</p> <p>Model No. GTM96181-18PD-T2</p> <p>Part No./Ordering No. TR9KZ900USBCFG2R6B</p>
	<p>Rev C2</p>



GlobTek's USB00016 USB Type C connector is:

- Shielded for improved EMI performance
- Unibody plug and PCB cover with integrated cable clamp provide superior ruggedability and prevents breakage as may be seen on simple USB C cables with separate plug and PCB components
- Cable clamp with overmold provides for very high pull force withstand
- More robust in terms of bending protection after plug is insert
- Less component stress during the manufacturing process like first step overmolding
- Superior cosmetic appearance

ADDITIONAL OUTPUT PLUG OPTIONS ARE AVAILABLE AT <https://www.globtek.com/connectors/>  
STANDARD PLUGS AND CONNECTORS CAN BE SEEN ONLINE AT <https://www.globtek.com/connectors/>  
CALCULATE VOLTAGE REGULATION/DROP WITH OUR ONLINE CALCULATOR: <https://en.globtek.com/output-cable-regulation-calculator/>

<p>GlobTek, Inc.  www.globtek.com  186 Veterans Drive,  Northvale, NJ 07647  Tel. (201) 784-1000  Fax (201) 784-0111</p>	<p>Drawing Title: GTM96181-18PD-T2, USB Adaptive Power Source ICT/ITE/Medical Power supply, Efficiency Level: USA DOE Level VI / Eco-design Directive 2009/125/EC, (EU) 2019/1782, Case Color/Style: GlobTek Black, Desktop/External, USB Adaptive Power Supply AC Adaptor, Input Rating: 100-240V~, 50-60 Hz, IEC 60320/C8 , Output Rating: 18W, 5.0V, 5.8V, 9.0V, 12.0V, 15.0V, 15.1V, 20.0VV@3.0A, 3.0A, 2.0A, 1.5A, 1.2A, 1.19A, 0.9AA, Output Configuration: 1000 mm, 2C 20 + 3C 28/5C + Shield Cond, N/A, USB Type-C Connector, Shielded, Unibody, Rugged, Ferrite: None, GlobTek Black, GT Cord # C59970, Pin Out: A1, A12, B1, B12: COM A4, A9, B4, B9: V+ CC1:A5, D+ :A6 D- : A7, Blades/Input Cord: Not Applicable, Approvals: UKCA; Morocco;</p>
	<p>Model No. GTM96181-18PD-T2</p>
	<p>Part No./Ordering No. TR9KZ900USBCFG2R6B</p>
	<p>Rev C2</p>

## OUTPUT CONNECTOR HOOK UP

TO ADDRESS SYSTEM-LEVEL EMI CONCERNS, FERRITE CHOKES/BEADS MAY BE ADDED/REVISED UPON REQUEST. A SAMPLE KIT OF GLOBTEK'S STANDARD FERRITES IS AVAILABLE UNDER GLOBTEK P/N: EMI-MITIGATION-KIT1

FOR ADDITIONAL INFORMATION, PLEASE READ OUR WHITE PAPER AT:

<https://en.globtek.com/technical-articles/ferrite-kit-radiated-emi-suppression-kit-for-globtek-power-supplies-cable-assemblies>

GlobTek, Inc. www.globtek.com 186 Veterans Drive, Northvale, NJ 07647 Tel. (201) 784-1000 Fax (201) 784-0111	Drawing Title: GTM96181-18PD-T2, USB Adaptive Power Source ICT/ITE/Medical Power supply, Efficiency Level: USA DOE Level VI / Eco-design Directive 2009/125/EC, (EU) 2019/1782, Case Color/Style: GlobTek Black, Desktop/External, USB Adaptive Power Supply AC Adaptor, Input Rating: 100-240V~, 50-60 Hz, IEC 60320/C8 , Output Rating: 18W, 5.0V, 5.8V, 9.0V, 12.0V, 15.0V, 15.1V, 20.0VV@3.0A, 3.0A, 2.0A, 1.5A, 1.2A, 1.19A, 0.9AA, Output Configuration: 1000 mm, 2C 20 + 3C 28/5C + Shield Cond, N/A, USB Type-C Connector, Shielded, Unibody, Rugged, Ferrite: None, GlobTek Black, GT Cord # C59970, Pin Out: A1, A12, B1, B12: COM A4, A9, B4, B9: V+ CC1:A5, D+ :A6 D- : A7, Blades/Input Cord: Not Applicable, Approvals: UKCA; Morocco;	
	Model No. GTM96181-18PD-T2	
	Part No./Ordering No. TR9KZ900USBCFG2R6B	Rev C2

**LABEL:L-1470**





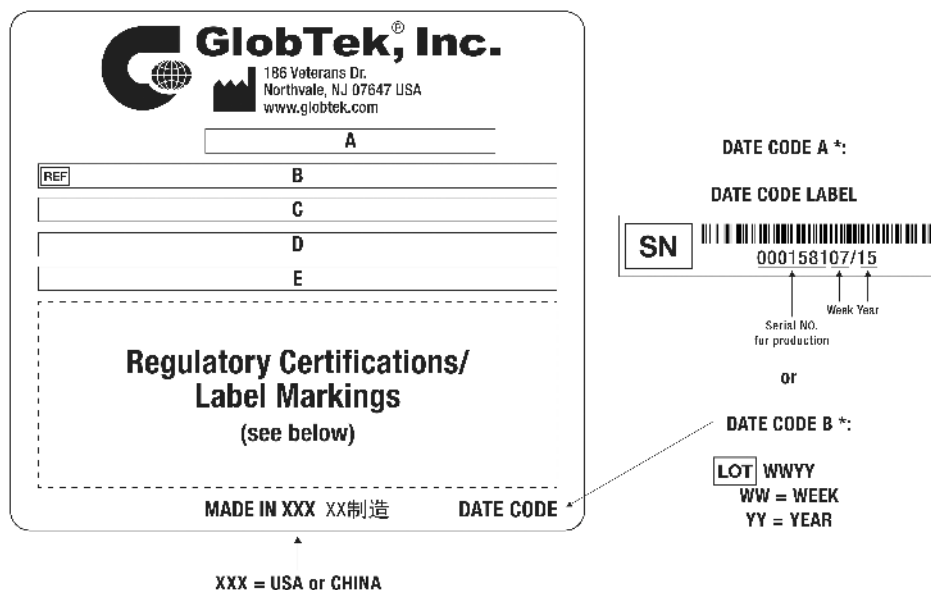

LABEL P/N	ISO 15223 medical device compliant label
MATERIAL	Flat Thermal Transfer, Imprintable, Polyester Label and/or Pad Printed and/or Molded, and/or Laser Engraved in the case
BACKGROUND COLOR	Black if housing is Black, White or Silver if housing is White or Gray.
TEXT COLOR	White or Silver if label is Black Background for Black housing. Black if label is White or Silver background and Housing is White or Gray.
LABEL WIDTH (mm)	36.5
LABEL HEIGHT (mm)	48.5
SPECIAL BARCODE LABEL MATERIAL	No

Below is the minimum information which will appear on the label. NOTE: in the logo area additional/actual positioning of symbols and text is subjected to change as per agency updates/requirements or additional model approvals become available. Agency logos may be in Regulatory Certifications/Label Markings area on the label or molded into the case housing outside the label area. Information will be shown via Label and/or Pad Printed and/or Molded in the case.



A=USB Adaptive Power Source ICT/ITE/Medical Power supply  
 B=P/N: (料号) TR9KZ900USBCFG2R6B  
 C=Model (型号) GTM96181-18PD-T2  
 D=Input (输入)100-240V~, 50-60 Hz, 1.2A

<p>GlobTek, Inc.  www.globtek.com  186 Veterans Drive,  Northvale, NJ 07647  Tel. (201) 784-1000  Fax (201) 784-0111</p>	<p>Drawing Title: GTM96181-18PD-T2, USB Adaptive Power Source ICT/ITE/Medical Power supply, Efficiency Level: USA DOE Level VI / Eco-design Directive 2009/125/EC, (EU) 2019/1782, Case Color/Style: GlobTek Black, Desktop/External, USB Adaptive Power Supply AC Adaptor, Input Rating: 100-240V~, 50-60 Hz, IEC 60320/C8 , Output Rating: 18W, 5.0V, 5.8V, 9.0V, 12.0V, 15.0V, 15.1V, 20.0VV@3.0A, 3.0A, 2.0A, 1.5A, 1.2A, 1.19A, 0.9AA, Output Configuration: 1000 mm, 2C 20 + 3C 28/5C + Shield Cond, N/A, USB Type-C Connector, Shielded, Unibody, Rugged, Ferrite: None, GlobTek Black, GT Cord # C59970, Pin Out: A1, A12, B1, B12: COM A4, A9, B4, B9: V+ CC1:A5, D+ :A6 D- : A7, Blades/Input Cord: Not Applicable, Approvals: UKCA; Morocco;</p>
	<p>Model No. GTM96181-18PD-T2</p>
	<p>Part No./Ordering No. TR9KZ900USBCFG2R6B <span style="float: right;">Rev C2</span></p>

<p>E=Output (輸出) 5.0V  3.0A  5.8V  3.0A  9.0V  2.0A  12.0V  1.5A  15.0V  1.2A  15.1V  1.19A  20.0V  0.9A</p> <p>F=GTF-7483-3</p>
---

GlobTek, Inc. www.globtek.com 186 Veterans Drive, Northvale, NJ 07647 Tel. (201) 784-1000 Fax (201) 784-0111	Drawing Title: GTM96181-18PD-T2, USB Adaptive Power Source ICT/ITE/Medical Power supply, Efficiency Level: USA DOE Level VI / Eco-design Directive 2009/125/EC, (EU) 2019/1782, Case Color/Style: GlobTek Black, Desktop/External, USB Adaptive Power Supply AC Adaptor, Input Rating: 100-240V~, 50-60 Hz, IEC 60320/C8 , Output Rating: 18W, 5.0V, 5.8V, 9.0V, 12.0V, 15.0V, 15.1V, 20.0VV@3.0A, 3.0A, 2.0A, 1.5A, 1.2A, 1.19A, 0.9AA, Output Configuration: 1000 mm, 2C 20 + 3C 28/5C + Shield Cond, N/A, USB Type-C Connector, Shielded, Unibody, Rugged, Ferrite: None, GlobTek Black, GT Cord # C59970, Pin Out: A1, A12, B1, B12: COM A4, A9, B4, B9: V+ CC1:A5, D+ :A6 D- : A7, Blades/Input Cord: Not Applicable, Approvals: UKCA; Morocco;	
	Model No. GTM96181-18PD-T2	
	Part No./Ordering No. TR9KZ900USBCFG2R6B	Rev C2

AGENCY ONLINE DOCUMENTS	<a href="http://www.globtek.info/certs/GTM96181-PD/">http://www.globtek.info/certs/GTM96181-PD/</a>
CE EC-Declaration for Medical	<a href="#">Contact GlobTek for more information</a>
CE EC-Declaration for Industrial/Commercial/ITE	<a href="http://globtek.force.com/models/ec_declaration_product?id=01t3a000005CdN6&amp;i=2">http://globtek.force.com/models/ec_declaration_product?id=01t3a000005CdN6&amp;i=2</a>
CE EC-Declaration for Household	<a href="#">Contact GlobTek for more information</a>
UKCA-Declaration for Medical	<a href="#">Contact GlobTek for more information</a>
UKCA-Declaration for Industrial/Commercial/ITE	<a href="http://globtek.force.com/models/ukca_declaration_product?id=01t3a000005CdN6&amp;i=2">http://globtek.force.com/models/ukca_declaration_product?id=01t3a000005CdN6&amp;i=2</a>
UKCA-Declaration for Household	<a href="#">Contact GlobTek for more information</a>
Morocco SDoC Declaration	<a href="https://globtek.secure.force.com/models/Morocco_SDoC_Declaration?id=a0O3a00000M3yu5EAB">https://globtek.secure.force.com/models/Morocco_SDoC_Declaration?id=a0O3a00000M3yu5EAB</a>
RoHS/RoHS3 Declaration	<a href="https://www.globtek.com/pdf/rohs_cert/01t3a000005CdN6AAK">https://www.globtek.com/pdf/rohs_cert/01t3a000005CdN6AAK</a>
REACH Declaration	<a href="https://www.globtek.com/pdf/iso_certificates/REACH.pdf">https://www.globtek.com/pdf/iso_certificates/REACH.pdf</a>
Conflict Minerals Declaration	<a href="https://www.globtek.com/pdf/conflict-minerals.pdf">https://www.globtek.com/pdf/conflict-minerals.pdf</a>
Prop 65 Statement	<a href="https://en.globtek.com/prop-65-statement.pdf">https://en.globtek.com/prop-65-statement.pdf</a>
IPXY rating is based on 3rd party testing and customers should check suitability and test system level IPXY rating before ordering.	

## Regulatory Certifications/Label Markings

Below follows a link to the latest regulatory certifications and marks for this specific product. National standards as well as certification schemes are constantly changing and so is the set of certification marks and symbols applicable to this product. Various standards, marks and symbols, and certificates are subject to change at any time without notice.

Additional standards or unique country certifications are available upon request. Please contact Globtek to request a quotation.

LATEST PRODUCT/MODEL CERTIFICATIONS: <https://www.globtek.com/datasheet/w70612>

AGENCY ONLINE DOCUMENTS <http://www.globtek.info/certs/GTM96181-PD/>



(F1) Class II / Double Insulated

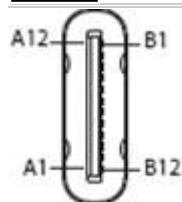

A1, A12, B1, B12: COM  
 A4, A9, B4, B9: V+  
 CC1:A5,  
 D+ :A6  
 D- : A7

[Mates with GlobTek USB Type C cables available at: https://en.globtek.com/cordsets/usb-cables-cords-assemblies](#)



GlobTek, Inc.  
 www.globtek.com  
 186 Veterans Drive,  
 Northvale, NJ 07647  
 Tel. (201) 784-1000  
 Fax (201) 784-0111

Drawing Title: GTM96181-18PD-T2, USB Adaptive Power Source ICT/ITE/Medical Power supply, Efficiency Level: USA DOE Level VI / Eco-design Directive 2009/125/EC, (EU) 2019/1782, Case Color/Style: GlobTek Black, Desktop/External, USB Adaptive Power Supply AC Adaptor, Input Rating: 100-240V~, 50-60 Hz, IEC 60320/C8 , Output Rating: 18W, 5.0V, 5.8V, 9.0V, 12.0V, 15.0V, 15.1V, 20.0VV@3.0A, 3.0A, 2.0A, 1.5A, 1.2A, 1.19A, 0.9AA, Output Configuration: 1000 mm, 2C 20 + 3C 28/5C + Shield Cond, N/A, USB Type-C Connector, Shielded, Unibody, Rugged, Ferrite: None, GlobTek Black, GT Cord # C59970, Pin Out: A1, A12, B1, B12: COM A4, A9, B4, B9: V+ CC1:A5, D+ :A6 D- : A7, Blades/Input Cord: Not Applicable, Approvals: UKCA; Morocco;

Model No. GTM96181-18PD-T2

Part No./Ordering No. TR9KZ900USBCFG2R6B

Rev C2

## PACKAGING

Packing Spec P/N	Standard, Cellular packaging
Box Qty	75
Gift Box Size (mm)	Egg Crate
Gift Box Color	None
Master Carton Size (mm)	455 x 430 x 320
Master Carton Cubic Volume (m <sup>3</sup> )	0.06
Master GW (Kg)	14.0 kg
BLADES INCLUDED	N/A: Not Applicable
BLADE/CORD INSTALLED	N/A: Not Applicable
USER MANUAL*	
USER MANUAL WEB LINK	

\* This specification sheet is considered the user manual for all applications. It is expected that the buyer of this product will use it to formulate their own user manual for their end product and a user manual specifically for the power adapter is not usually required. If a user manual is not specifically listed above then none will be provided with this unit.

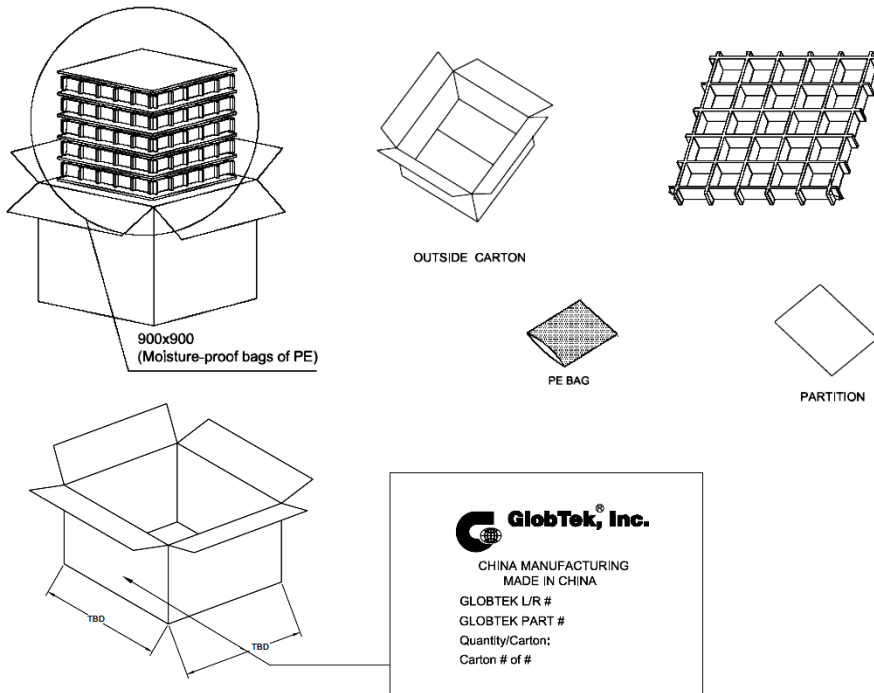

### PROPRIETARY INFORMATION

<p>GlobTek, Inc. www.globtek.com 186 Veterans Drive, Northvale, NJ 07647 Tel. (201) 784-1000 Fax (201) 784-0111</p>	<p>Drawing Title: GTM96181-18PD-T2, USB Adaptive Power Source ICT/ITE/Medical Power supply, Efficiency Level: USA DOE Level VI / Eco-design Directive 2009/125/EC, (EU) 2019/1782, Case Color/Style: GlobTek Black, Desktop/External, USB Adaptive Power Supply AC Adaptor, Input Rating: 100-240V~, 50-60 Hz, IEC 60320/C8 , Output Rating: 18W, 5.0V, 5.8V, 9.0V, 12.0V, 15.0V, 15.1V, 20.0VV@3.0A, 3.0A, 2.0A, 1.5A, 1.2A, 1.19A, 0.9AA, Output Configuration: 1000 mm, 2C 20 + 3C 28/5C + Shield Cond, N/A, USB Type-C Connector, Shielded, Unibody, Rugged, Ferrite: None, GlobTek Black, GT Cord # C59970, Pin Out: A1, A12, B1, B12: COM A4, A9, B4, B9: V+ CC1:A5, D+ :A6 D- : A7, Blades/Input Cord: Not Applicable, Approvals: UKCA; Morocco;</p>
	<p>Model No. GTM96181-18PD-T2</p>
	<p>Part No./Ordering No. TR9KZ900USBCFG2R6B</p>
	<p>Rev C2</p>

## INSTRUCTIONS TO THE OEM SYSTEMS ENGINEER

It is the responsibility of the OEM systems engineer to provide the end system user instructions and warnings for the use of this product in the end system.

If an input cord is required for this product, AC Mains voltage should be provided to the power supply by a power supply cord approved to the national standards of the country in which it will be used.

This product is not designed to be repaired. No serviceable parts inside. A blown internal fuse is an indication of catastrophic failure of circuit component(s). If a Failure Analysis is required for a failed power supply/battery charger, please return the damaged unit to GlobTek for an accurate determination of the root cause of the failure.

EMC Compliance of the complete OEM product, including the GlobTek power supply/battery charger needs to be verified by the OEM systems engineer.

## INSTRUCTION SHEET

---

<p>GlobTek, Inc.  www.globtek.com  186 Veterans Drive,  Northvale, NJ 07647  Tel. (201) 784-1000  Fax (201) 784-0111</p>	<p>Drawing Title: GTM96181-18PD-T2, USB Adaptive Power Source ICT/ITE/Medical Power supply, Efficiency Level: USA DOE Level VI / Eco-design Directive 2009/125/EC, (EU) 2019/1782, Case Color/Style: GlobTek Black, Desktop/External, USB Adaptive Power Supply AC Adaptor, Input Rating: 100-240V~, 50-60 Hz, IEC 60320/C8 , Output Rating: 18W, 5.0V, 5.8V, 9.0V, 12.0V, 15.0V, 15.1V, 20.0VV@3.0A, 3.0A, 2.0A, 1.5A, 1.2A, 1.19A, 0.9AA, Output Configuration: 1000 mm, 2C 20 + 3C 28/5C + Shield Cond, N/A, USB Type-C Connector, Shielded, Unibody, Rugged, Ferrite: None, GlobTek Black, GT Cord # C59970, Pin Out: A1, A12, B1, B12: COM A4, A9, B4, B9: V+ CC1:A5, D+ :A6 D- : A7, Blades/Input Cord: Not Applicable, Approvals: UKCA; Morocco;</p>
	<p>Model No. GTM96181-18PD-T2</p>
	<p>Part No./Ordering No. TR9KZ900USBCFG2R6B</p>
	<p>Rev C2</p>

