



ZOHO

LED Flood Light



ZOHO Flood Light

Beyond LED's ZOHO Flood lights are the best solutions to replace HID lamps. Superior performance and robust design make this product suitable for any general-purpose floodlighting application such as landscape, signage, and accent lighting in heavy commercial and residential applications.

- Up to 135 Lumens per watt
- Standard attached U-bracket with optional Yoke and Knuckle mount
- Die-Cast aluminum housing
- Heat resistant polycarbonate optical lens
- Universal 100-277Vac

ZOHO LED Flood Light

SKU #	Model #	Watts	Lumens	CCT	Housing	Type	Input Voltage	Certifications
151144	BLTSFLD30WAT1A1-50K	30W	3432Lm	5000K	Black	Knuckle	100-277Vac	UL & DLC
151162	Optional Black Yoke Mount							
151661	BLTSFLD50WAT1A1-50K	50W	6200Lm	5000K	Bronze	U-Bracket	100-277Vac	UL & DLC
151662	Optional Bronze Knuckle Mount							

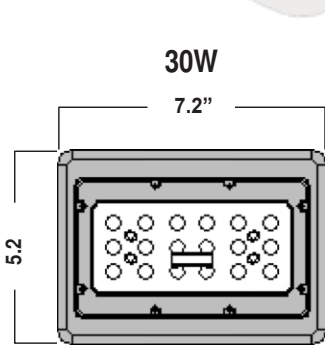

30W Knuckle



Optional 30W Yoke

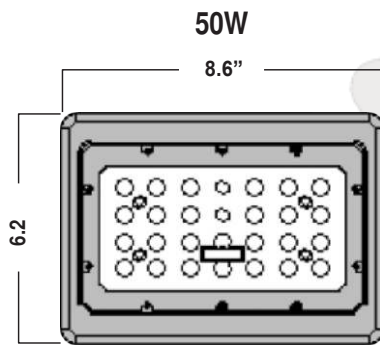

50W U-Bracket



Optional 50W Yoke

CORRELATED COLOR TEMPERATURE (CCT)

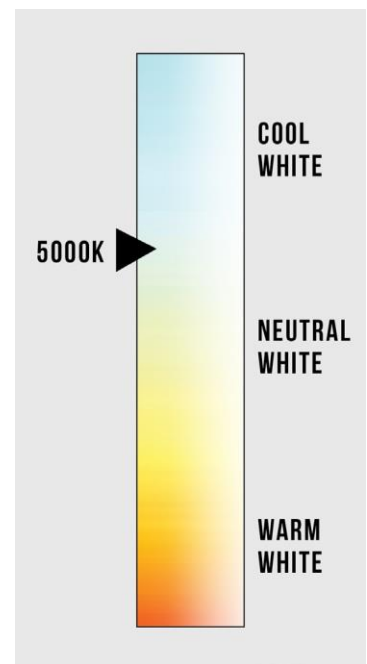

ZOHO

LED Flood Light

Specifications - 30W

Color temperature	5000K
CRI	>70
Lumen	3432Lm
Input Power	30W
Viewing Angle	7H7V
Input Voltage	100-277Vac 50/60Hz
Driver model	Beyond Brand Driver
Optional	Surge Protection Device
PF	>0.9
Waterproof Rating	WET (IP65)

LED Brand	LUMILEDS
LED Type	LUXEON 3030 2D
LED QTY	36PCS
Housing	Aluminum +PC+Steel
Housing color	Black

Operating Temperature	-20°C to 45°C
Operating Humidity	20%-90% RH
Storage Temperature	-30°C to 80°C
Storage Humidity	10%-95%
Application	Outdoor / Indoor
Safety Certification	UL, cUL, DLC
Warranty Time	5 Years

Dimensions

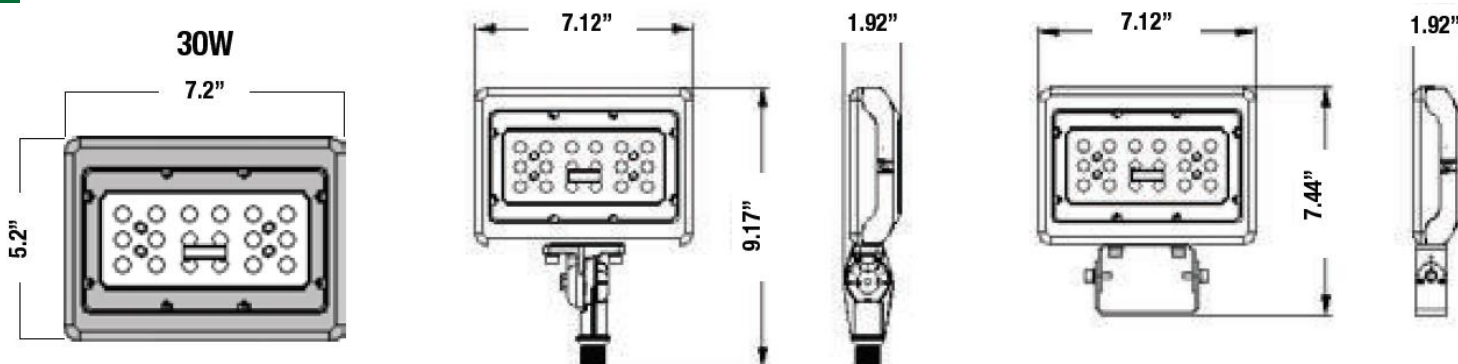

ZOHO

LED Flood Light

Distribution Diagram - 30W

DATA OF LAMP		PHOTOMETRIC DATA			
MODEL		I_{max} (cd)	1437	S/MH (C0/180)	1.28
NOMINAL POWER (W)	30	LOR (%)	100.0	S/MH (C90/270)	1.30
RATED VOLTAGE (V)	120	TOTAL FLUX (lm)	3736.9	η UP, DN (C0-180)	0.1, 50.6
NOMINAL FLUX (lm)	3736.91	CIE CLASS	DIRECT	η UP, DN (C180-360)	0.1, 49.3
LAMPS INSIDE	1	η up (%)	0.1	CIBSE SHR NOM	1.25
TEST VOLTAGE (V)	120.0	η down (%)	99.9	CIBSE SHR MAX	1.35

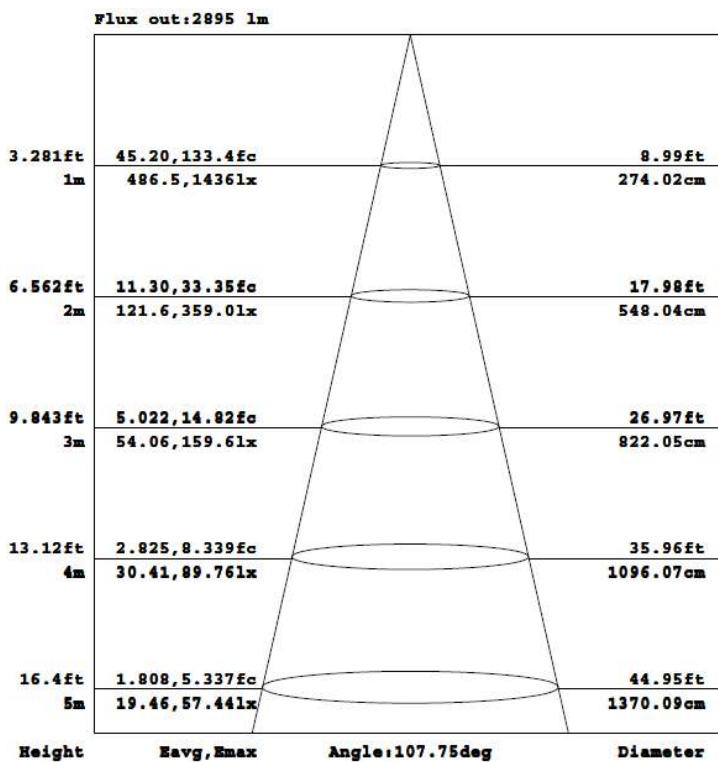
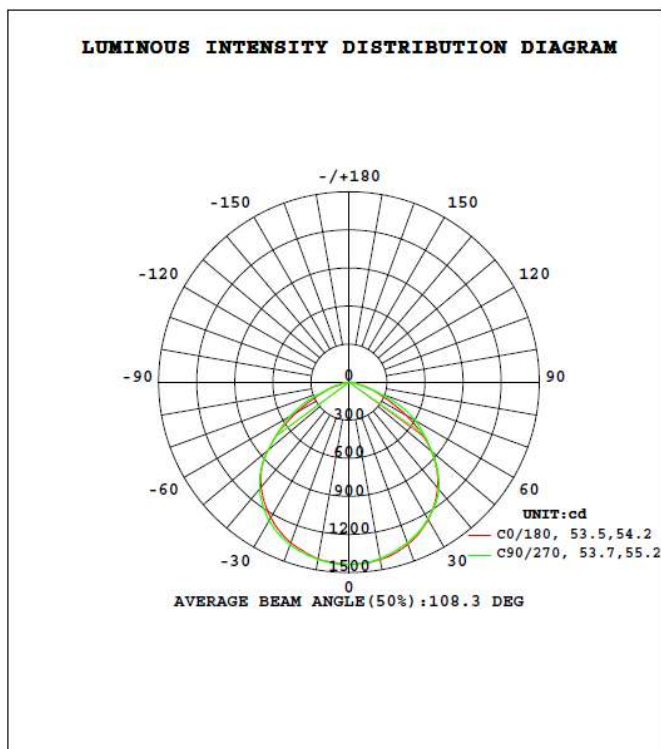

Note: The Curves indicate the illuminated area and the average illumination when the luminaire is at different distance.

ZOHO

LED Flood Light

Specifications - 50W

Color temperature	5000K
CRI	>70
Lumen	6200Lm
Input Power	50W
Viewing Angle(10%)	150°
Input Voltage	100-277Vac 50/60Hz
Driver model	Beyond Brand Driver
Surge Protection Device	optional
PF	>0.9
Waterproof Rating	WET (IP65)

LED Brand	PHILIPS LUMILEDS
LED Type	LUXEON 3030 2D
LED QTY	56PCS
Housing	Aluminum +PC+Steel
Housing color	Bronze

Operating Temperature	-20°C to 45°C
Operating Humidity	20%-90% RH
Storage Temperature	-30°C to 80°C
Storage Humidity	10%-95%
Application	Outdoor / Indoor
Safety Certification	UL, cUL, DLC
Warranty Time	5 Years

Dimensions

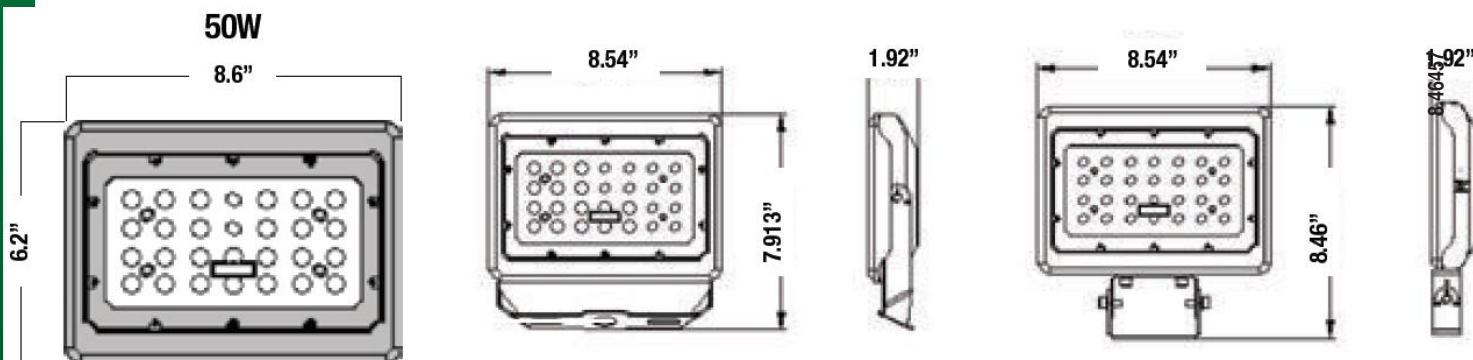

ZOHO

LED Flood Light

Distribution Diagram - 50W

DATA OF LAMP		PHOTOMETRIC DATA Eff: 133.25 lm/W			
MODEL		I _{max} (cd)	2635	S/MH (C0/180)	1.31
NOMINAL POWER (W)	50	LOR (%)	100.0	S/MH (C90/270)	1.31
RATED VOLTAGE (V)	120	TOTAL FLUX (lm)	6978.5	η UP, DN (C0-180)	0.1, 49.5
NOMINAL FLUX (lm)	6978.53	CIE CLASS	DIRECT	η UP, DN (C180-360)	0.1, 50.4
LAMPS INSIDE	1	η up (%)	0.2	CIBSE SHR NOM	1.25
TEST VOLTAGE (V)	120.0	η down (%)	99.8	CIBSE SHR MAX	1.35

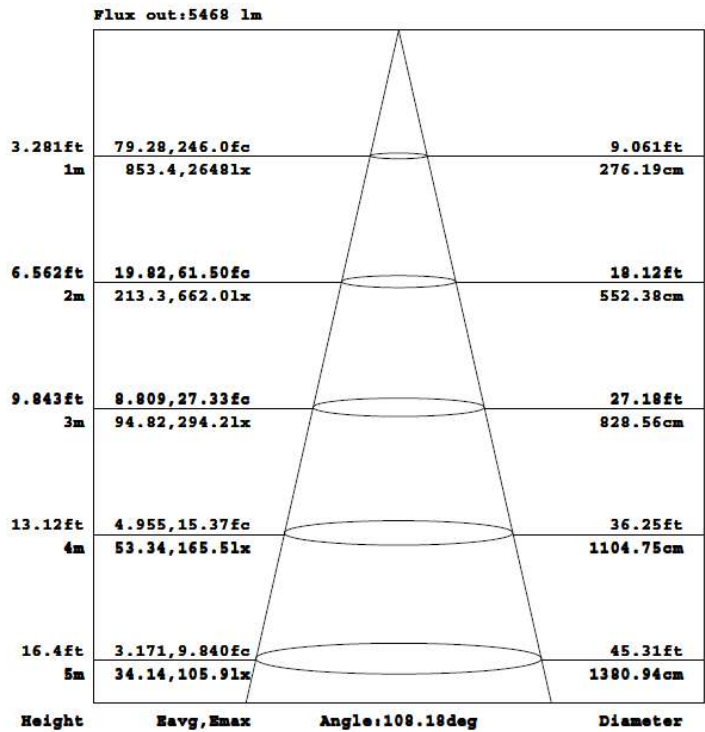
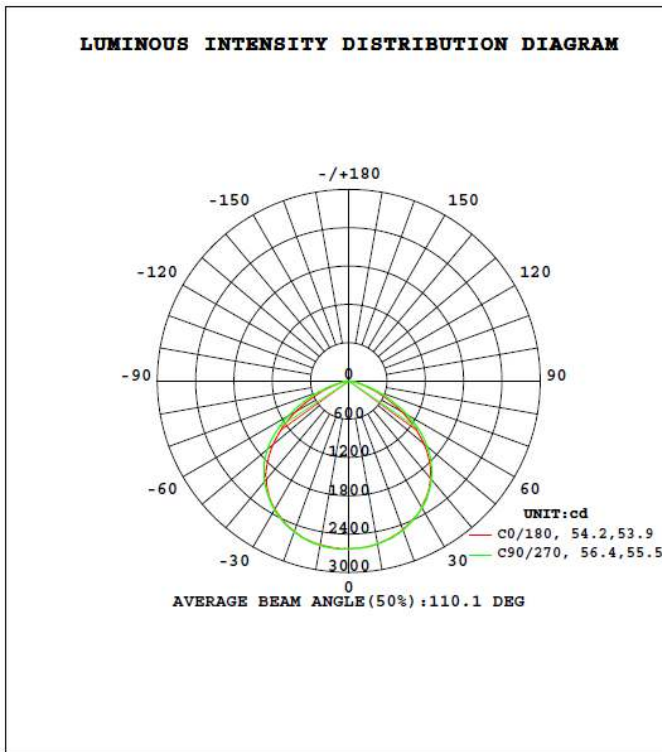

Note: The Curves indicate the illuminated area and the average illumination when the luminaire is at different distance.

ZOHO

LED Flood Light

Packaging

Tolerance of Carton Size: ± 0.590551 in, Tolerance of Weight: $\pm 10\%$.

Model	Pcs/Box	Dimensions	Weight
30W Knuckle Mount	1	12" X 9" X 3"	3 Lb
30W Yoke Mount	1	12" X 9" X 3"	3 Lb
50W U-Bracket Mount	1	13" X 11" X 4"	4 Lb
50W Yoke Mount	1	13" X 11" X 4"	4 Lb

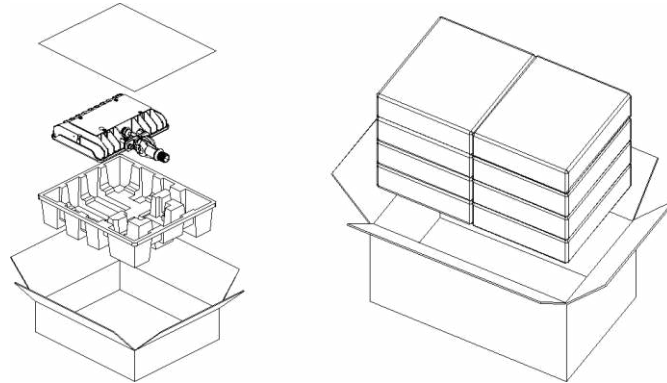

ZOHO

LED Flood Light

Mount Types

30W



50W



User Notice

- Please turn off the power before installing or changing assembly parts.
- The input voltage and lamps should be matching. Before connecting the power line, please make sure the wiring section is insulated.
- Only professionals should install and disassemble the lamps.

Trouble Shooting

- Flickering light - Turn off the power and turn on again in 3 minutes. If the same phenomena occurs, then call support.
- Not working - Please check all power connections.

(866) 786-1117 • www.BeyondLEDTechnology.com

Due to continuous product improvement, information in this document is subject to change.

ZOHO

LED Flood Light

Instructions

LED Flood Light Instruction

Cautions:

1. Can not use the electric generator to test the LED lamp.
2. Please abide by related country, regional and local law and regulations when install this fixture.
3. Please turn off the power before installation or maintenance.
4. Proper earth grounding is required to ensure safety.

Notice:

1. To avoid possibility of electrical shock or fire, the installation personnel must have professional electric knowledge.
2. Please wear gloves to avoid injury before installation.
3. If any smoke or spark of the wire happened, please turn off the power immediately and notify relevant personnel.1. To avoid possibility of electrical shock or fire, the installation personnel must have professional electric knowledge.

Attention:

1. Please check if there is any damage during shipping. If so, please contact manufacturer timely.
2. Please read the installation instruction carefully to check whether all the accessories are complete. After confirmation, then install the fixture according to installation steps.

Instruction:

Different power of this light is different. Please refer to the corresponding installation instructions.

Wiring Diagram :

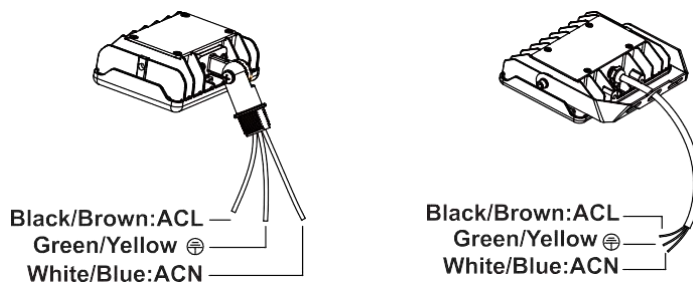

Installation 1: Adjustable fitter mounting

1.1 Installed with mounting bracket (suitable for 15W)

- Step 1: Take the lamp out of package;
- Step 2: pass the three wire through rubber mat; (figure 1.1)
- Step 3: Match the hole of rubber mat with bracket, pass wire through and fix it with screws(Watch out not to scratch the wire); (figure 1.2)
- Step 4: Pass the wire through from the other bracket and fix it with screws.(Watch out not to scratch the wire); (figure 1.3)

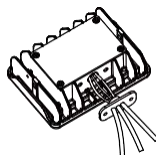

figure 1.1

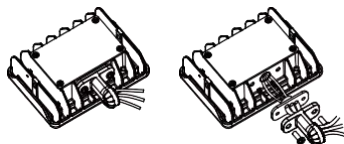

figure 1.2

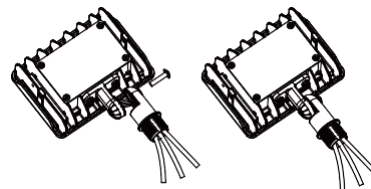

figure 1.3

ZOHO

LED Flood Light

Instructions

1.2 Installed with mounting bracket (suitable for 30W、50W)

Step 1: Take the lamp out of package;

Step 2: pass the wire through hardware and rubber mat; (figure 1.4)

Step 3: Match the hole of hardware and rubber mat with bracket, pass wire through and fix it with screws(Watch out not to scratch the wire); (figure 1.5)

Step 4: Pass the wire through from the other bracket and fix it with screws.(Watch out not to scratch the wire) (figure 1.6)

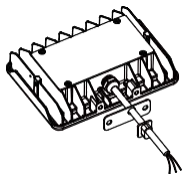

figure 1.4

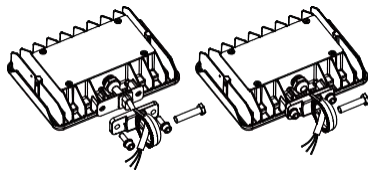

figure 1.5

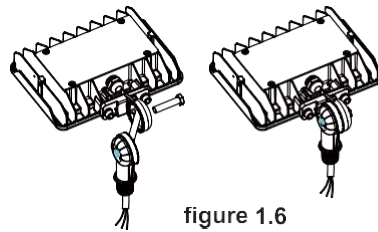

figure 1.6

1.3 Installed with whole lamp (suitable for 15W、30W、50W)

Step 1: Take the lamp out of package;

Step 2: Finish the wire connection according to the right mode of connection (pay attention to positive wire, negative wire, and ground wire), and then put wire into lamp pole; (figure 1.7)

Step 3: Loosen screws; Adjust lamp angles as per actual demands and tighten screws later;

Tips: Angles of the lamp is adjustable

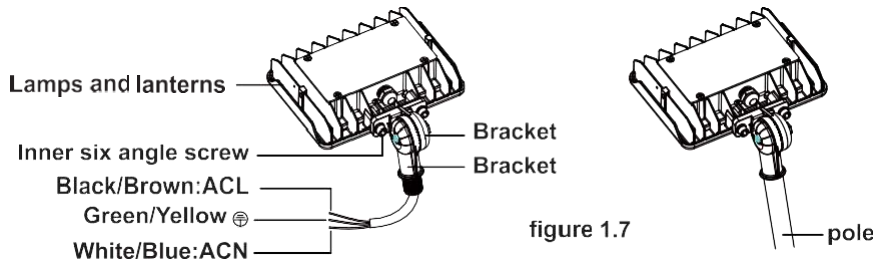

Installation 2: Yoke mounting

2.1 Installed with mounting bracket(suitable for all power of this series)

Step 1: Take the lamp out of package;

Step 2: Pass the wire through hole of bracket; (figure 2.1)

Step 3: Fix the lamp and bracket together with screws;(Watch out not to scratch the wire)(figure 2.2)

Step 4: Tighten the other bracket with screws (figure 2.3)

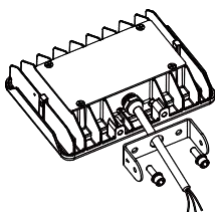

figure 2.1

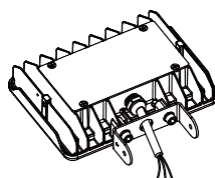

figure 2.2

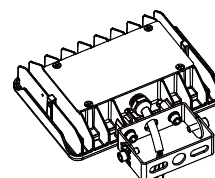

figure 2.3

ZOHO

LED Flood Light

Instructions

2.2 Installed with whole lamp(suitable for all power of this series)

Step 1: Take the lamp out of package;

Step 2: Finish the wire connection according to the right mode of connection (pay attention to positive wire, negative wire, and ground wire), and then put wire into lamp pole. (figure 2.4)

Step 3: Loosen screws; Adjust lamp angles as per actual demands and tighten screws later.(figure 2.5)

Tips: Angles of the lamp is adjustable

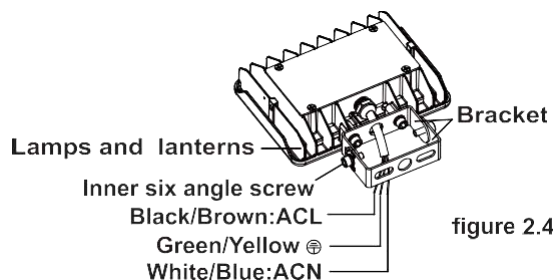

figure 2.4

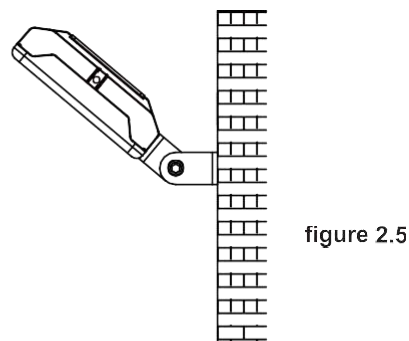

figure 2.5

Installation 3: Flood mounting

3.1 Installed with mounting bracket(suitable for all power of this series)

Step 1: Take the lamp out of package;(figure 3.1)

Step 2:Tighten the brackets and screws. (figure 3.2)

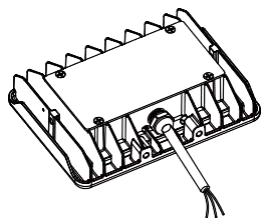

figure 3.1

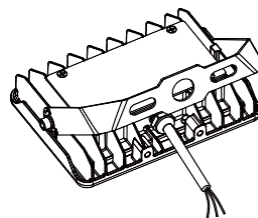

figure 3.2

3.2 Installed with whole lamp(suitable for all power of this series)

Step 1: Take the lamp out of package;

Step 2: Finish the wire connection according to the right mode of connection (pay attention to positive wire, negative wire, and ground wire), then put the wire into the lamp pole; (figure 3.3)

Step 3: Loosen screw; Adjust lamp angles as per actual demands and tighten screws later.(figure 3.4)

Tips: Angles of the lamp is adjustable

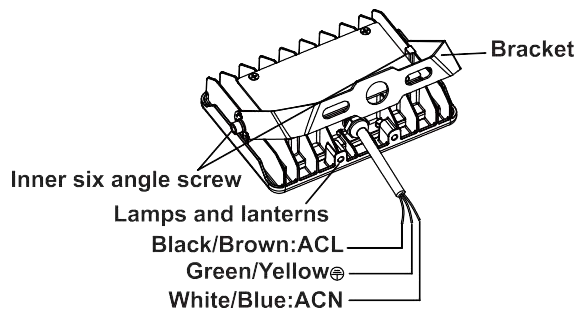

figure 3.3

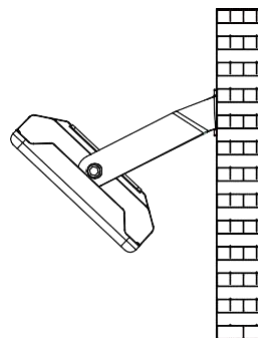

figure 3.4

ZOHO

LED Flood Light

Instructions

**MIN 75 °C SUPPLY CONDUCTOR.
THIS PRODUCT MUST BE INSTALLED IN ACCORDANCE WITH THE
APPLICABLE INSTALLATION CODE BY A PERSON FAMILIAR WITH THE
CONSTRUCTION AND OPERATION OF THE PRODUCT AND THE HAZARDS
INVOLVED**

Application

