

MCC 134

Thermocouple DAQ HAT for Raspberry Pi®



The MCC 134 is a 24-bit, 4-channel HAT add-on board for thermocouple measurements. The board is shown here connected to a Raspberry Pi (not included).

Features

- Four isolated thermocouple inputs
- 24-bit A/D converter
- 1 second update interval, minimum
- Thermocouple types J, K, R, S, T, N, E, and B supported
- Cold junction compensation
- Linearization
- Screw terminal connections
- Stack up to eight MCC HATs onto a single Raspberry Pi

Software

- MCC DAQ HAT Library; available on GitHub

Supported Operating Systems

- Linux®

Programming API

- C, C++, Python

Overview

The MCC 134 is a thermocouple measurement HAT (Hardware Attached on Top) designed for use with Raspberry Pi, the most popular single-board computer on the market today.

A HAT is an add-on board with a 40W GPIO (general purpose input/output) connector that conforms to the Raspberry Pi HAT specification.

The MCC 134 HAT provides four isolated thermocouple inputs. Up to eight MCC DAQ HATs can be stacked onto one Raspberry Pi.

Raspberry Pi Interface

The MCC 134 header plugs into the 40-pin general purpose I/O (GPIO) connector on a user-supplied Raspberry Pi. The MCC 134 was tested for use with all Raspberry Pi models with the 40-pin GPIO connector.

HAT Configuration

HAT configuration parameters are stored in an on-board EEPROM that allows the Raspberry Pi to automatically set up the GPIO pins when the HAT is connected.

Stackable HATs

Up to eight MCC DAQ HAT boards can be stacked onto a single Raspberry Pi. Users can mix and match MCC HAT models in the stack.

Thermocouple Input

Users can connect up to four differential thermocouples (TC) to the MCC 134 input channels. TC types are software-selectable per channel. TC values can be updated every 1 second, minimum.

Thermocouple inputs are electrically isolated from the Raspberry Pi to minimize noise and provide protection from harsh electrical environments.

Cold-Junction Compensation

The MCC 134 has three high-resolution cold-junction compensation (CJC) sensors.

Open-Thermocouple Detection

The MCC 134 is equipped with open-thermocouple detection (OTD) for all TC input channels so users can monitor the board for broken or disconnected thermocouples.

Power

The MCC 134 is powered with 3.3 V and 5 V provided by the Raspberry Pi through the GPIO header connector.

MCC DAQ HAT Library

The open-source MCC DAQ HAT Library of commands in C/C++ and Python allows users to develop applications on the Raspberry Pi using Linux.

The library is available to download from [GitHub](#). Comprehensive API and hardware [documentation](#) is available.

The MCC DAQ HAT Library supports operation with multiple MCC DAQ HATs running concurrently.

Console-based and user interface (UI) example programs are available.

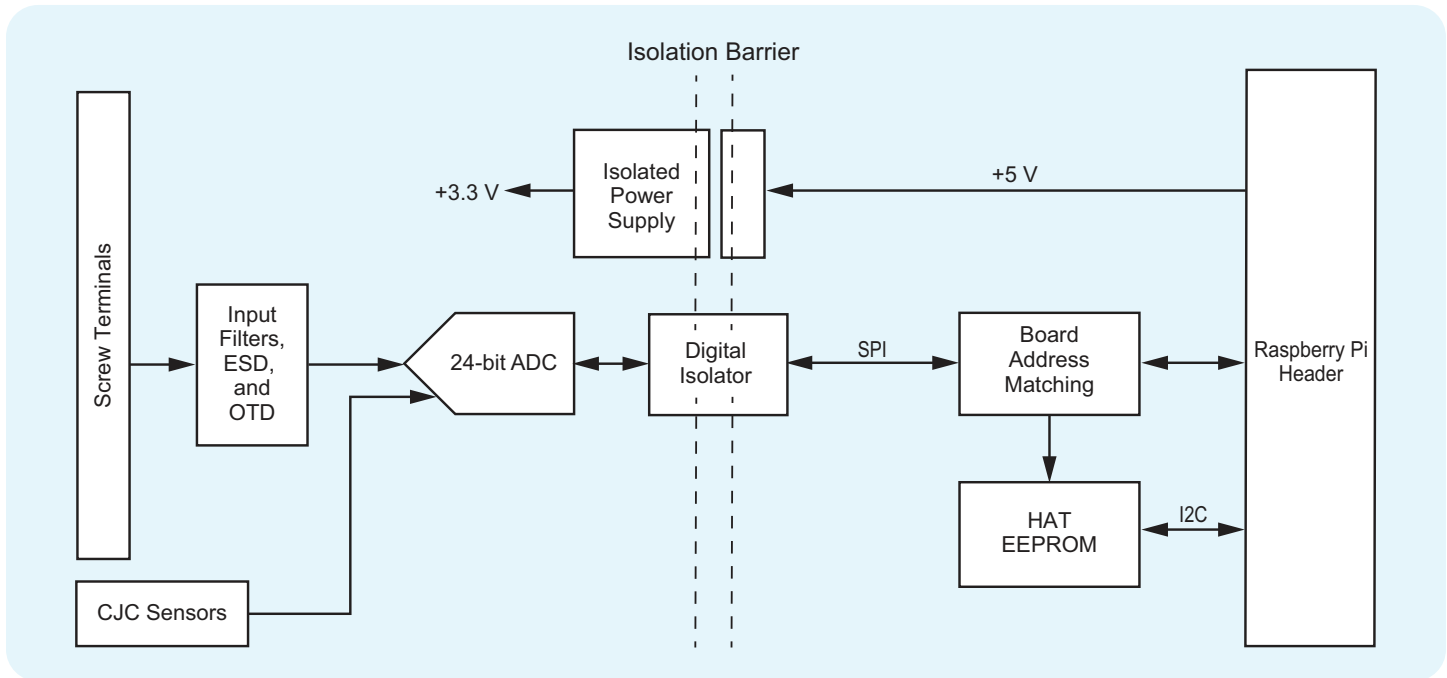

Best Practices for Accurate Thermocouple Measurements

The MCC 134 should achieve results within the maximum thermocouple accuracy specifications when operating within the documented environmental conditions. Operating in conditions with excessive temperature transients or airflow may affect results. In most cases, the MCC 134 will achieve the typical specifications. To achieve the most accurate thermocouple readings, MCC recommends the following practices:

- *Reduce the load on the Raspberry Pi processor.* Running a program that fully loads all 4 cores on the Raspberry Pi processor can raise the temperature of the processor above 70 °C. Running a program that only loads 1 core will operate approximately 20 °C cooler.
- *Minimize environmental temperature variations.* Place the MCC 134 away from heat or cooling sources that cycle on and off. Sudden environmental changes may lead to increased errors.
- *Provide a steady airflow, such as from a fan.* A steady airflow can dissipate heat and reduce errors.
- *When configuring multiple MCC DAQ Hats in a stack, position the MCC 134 farthest from the Raspberry Pi board.* Since the Raspberry Pi is a significant heat source, placing the MCC 134 farthest from the Pi will increase accuracy.

For additional information, refer to the [Measuring Thermocouples with the Raspberry Pi and the MCC 134](#) Tech Tip.

Stackable

Connect up to eight MCC DAQ HATs onto a single Raspberry Pi. Configure onboard jumpers to identify each board in the stack.



MCC 134

Example Programs



MCC DAQ HAT Examples

The MCC DAQ HAT Library includes example programs developed in C/C++ and Python that users can run to become familiar with the DAQ HAT library and boards; source code is included.

Console-Based (C/C++)

The compiled console example reads and displays the value of each thermocouple channel in a software timed loop.

```
File Edit Tabs Help
pi@janet_pi:~/daqhats_dev/examples/c/mcc134/single_value_read $ ./single_value_read
MCC 134 single data value read example
Function demonstrated: mcc134_t_in_read
Channels: 0 - 3

Press 'Enter' to continue

Acquiring data ... Press 'Enter' to abort

Sample  Channel 0  Channel 1  Channel 2  Channel 3
71       25.89 C   31.35 C   30.28 C   Open
```

Continuously read and display the value of each thermocouple input

User Interface

Example programs featuring a user interface are provided in different formats. Examples of each are shown here.

DataLogger (C/C++)

The datalogger example acquires data from the MCC 134, displays the data on a strip chart, and logs the data to a CSV file. This example can be run from the terminal.

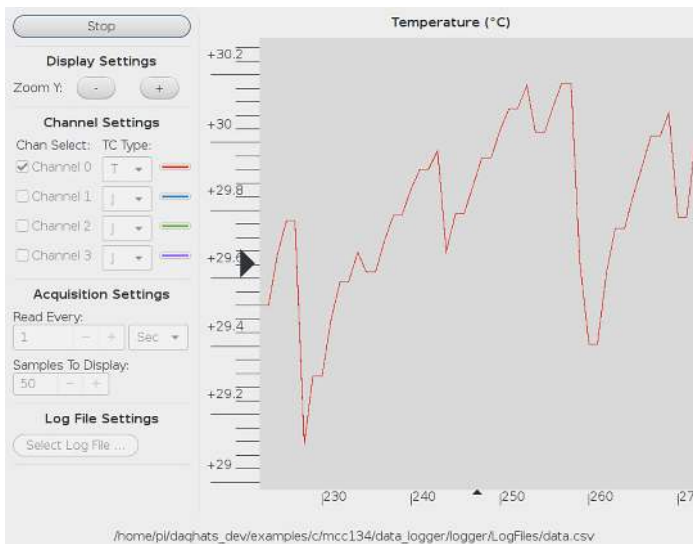

Configure options, plot data on a strip chart, and log data to a file

Web Server (Python)

The web server example lets users configure acquisition options and view acquired data from a browser window. This example is written for Python (source included).

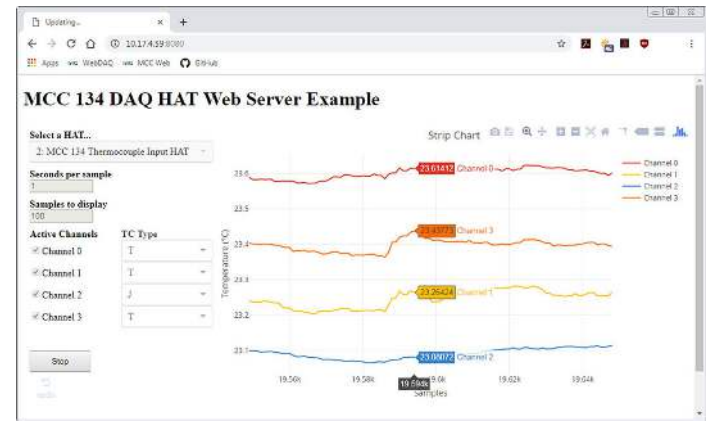

Configure options and view strip chart data from your browser

IFTTT Applet (Python)

IFTTT (If This Then That) is a free web-based service that interacts with apps and hardware to automate various functions. An IFTTT account is required.

The DAQ HAT Library includes two IFTTT example programs written for Python (source included):

- The logging example reads one channel at regular intervals and writes the data to a Google Sheets spreadsheet. Users can remotely monitor the spreadsheet from Google Drive (shown below).
- The alarm example monitors one channel and sends an email if the channel value meets specified criteria.

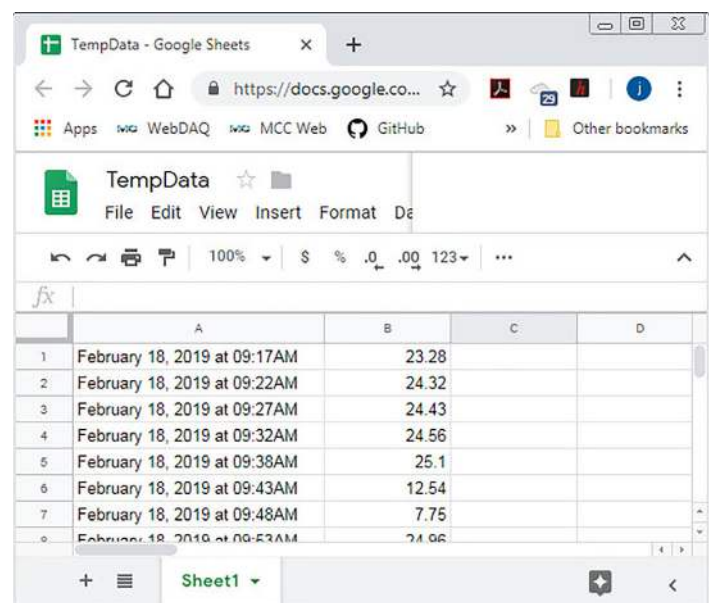

Remotely monitor acquired data from your browser

All specifications are subject to change without notice.
Typical for 25 °C unless otherwise specified.

Thermocouple input

A/D converters: Delta-Sigma

ADC resolution: 24 bits

Number of channels: 4

Input isolation

Between input and Raspberry Pi ground: 500 Vpk withstand max

Differential input voltage range: ± 78.125 mV

Common mode voltage range

Between any CHx+ or - input and any other input: 0.8 V max

Absolute maximum input voltage

Between any two TCx inputs: ± 25 V (power on), ± 25 V (power off)

Differential input impedance: 40 M Ω

Input current: 83 nA

Common mode rejection ($f_{in} = 50$ Hz or 60 Hz): 100 dB

Update interval: 1 second min

Open thermocouple detect response time: 2 seconds

Recommended Warm-up time: 15 minutes min

Calibration method: Factory

Compatible thermocouples

J: -210 °C to 1200 °C

K: -270 °C to 1372 °C

R: -50 °C to 1768 °C

S: -50 °C to 1768 °C

T: -270 °C to 400 °C

N: -270 °C to 1300 °C

E: -270 °C to 1000 °C

B: 50 °C to 1820 °C

Accuracy

Thermocouple measurement accuracy

Thermocouple accuracy specifications, including typical CJC measurement error. All specifications are (\pm).

Note 1: Thermocouple measurement accuracy specifications include polynomial linearization, cold-junction compensation error, and system noise. Accuracies shown do not include inherent thermocouple error or large temperature gradients across the board. Contact your thermocouple supplier for details on the inherent thermocouple accuracy error. The accuracy specifications assume the device has been warmed up for the recommended 15 minutes.

Note 2: To avoid excessive cold-junction compensation errors, operate the device in a stable temperature environment and away from heat sources that could cause temperature gradients across the board. Refer to the documentation for ways to decrease this error.

Note 3: When thermocouples are attached to conductive surfaces, the voltage differential between multiple thermocouples must remain within ± 0.8 V. For best results MCC recommends using electrically insulated thermocouples when possible.

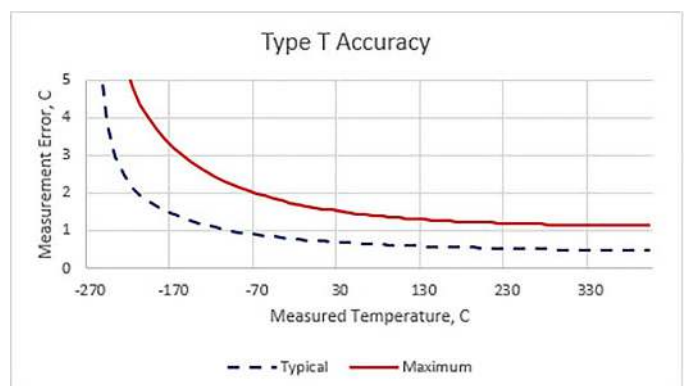
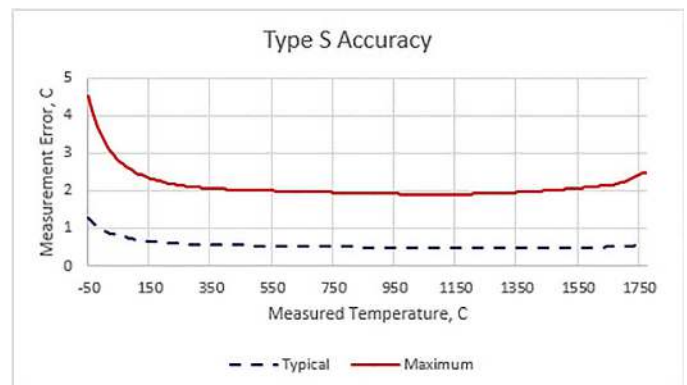
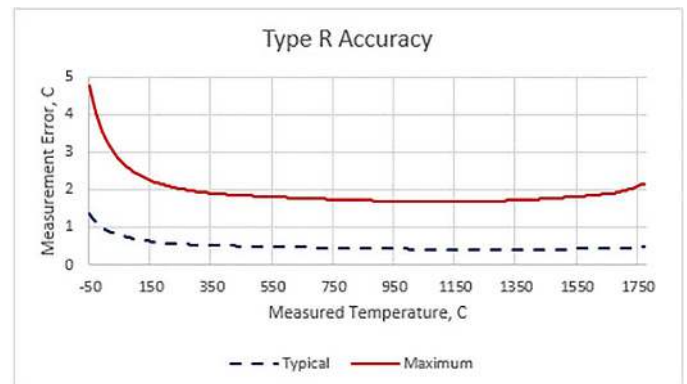
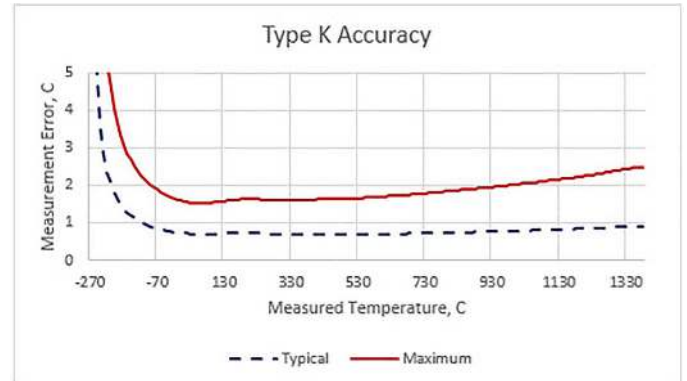
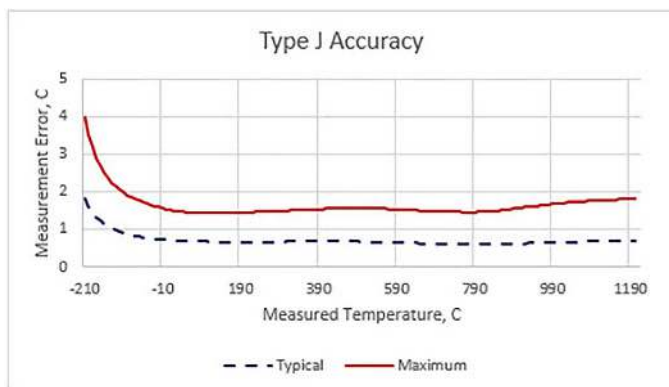

MCC 134

Specifications and Ordering

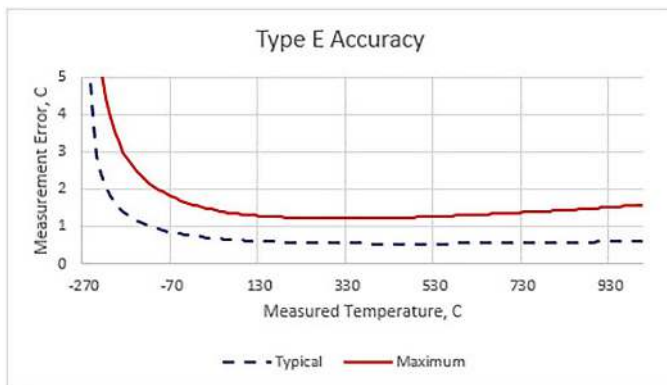
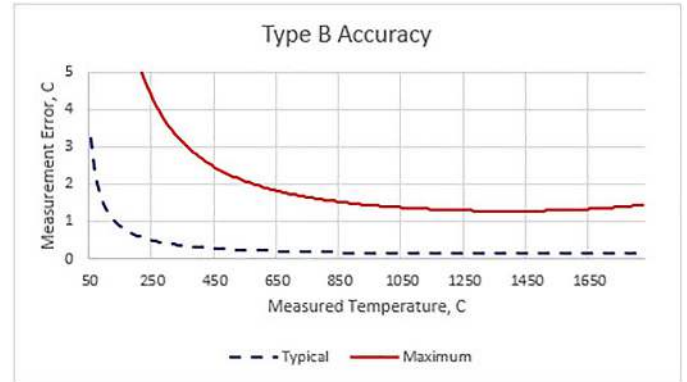
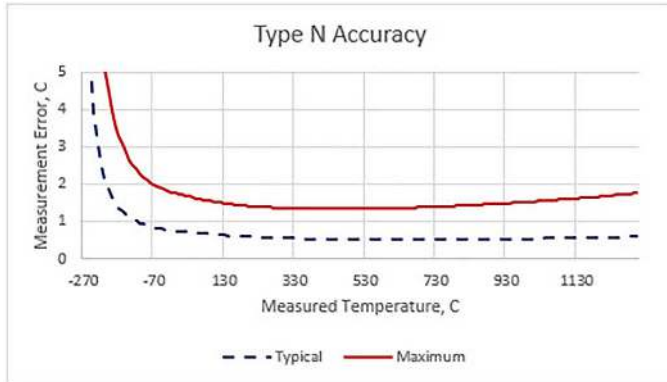

Memory

Non-volatile memory: 4 KB (ID and calibration storage, no user-modifiable memory)

Power

Supply current

5 V supply: 16 mA typ, 24 mA max

3.3 V supply: 1 mA typ, 5 mA max

Interface

Raspberry Pi GPIO pins used:

GPIO 8, GPIO 9, GPIO 10, GPIO 11 (SPI interface)

ID_SD, ID_SC (ID EEPROM)

GPIO 12, GPIO 13, GPIO 26, (Board address)

Data interface type:

SPI slave device, CEO chip select

SPI mode: 1

SPI clock rate: 10 MHz, max

Environment

Operating temperature: 0 °C to 55 °C

Storage temperature: -40 °C to 85 °C max

Relative humidity: 0% to 90% non-condensing

Mechanical

Dimensions (L × W × H): 65 × 56.5 × 12 mm (2.56 × 2.22 × 0.47 in.) max

Order Information

Hardware

Part No.	Description
MCC 134	4-channel thermocouple measurement DAQ HAT. Raspberry Pi model with the 40-pin GPIO connector required.

Software

Part No.	Description
MCC HAT Library	Open-source library for developing applications in C, C++, and Python on Linux for MCC DAQ HAT hardware. Available for download on GitHub at https://github.com/mccdaq/daqhats .

Accessories

Part No.	Description
745690-E001	E-type thermocouples wire, fiberglass (0 °C to 482 °C, 32 °F to 900 °F), 1 m
745690-E002	E-type thermocouples wire, fiberglass (0 °C to 482 °C, 32 °F to 900 °F), 2 m
745690-J001	J-type thermocouples wire, fiberglass (0 °C to 482 °C, 32 °F to 900 °F), 1 m
745690-J002	J-type thermocouples wire, fiberglass (0 °C to 482 °C, 32 °F to 900 °F), 2 m
745690-K001	K-type thermocouples wire, fiberglass (0 °C to 482 °C, 32 °F to 900 °F), 1 m
745690-K002	K-type thermocouples wire, fiberglass (0 °C to 482 °C, 32 °F to 900 °F), 2 m
745690-T001	T-type thermocouples wire, fiberglass (0 °C to 260 °C, 32 °F to 500 °F), 1 m
745690-T002	T-type thermocouples wire, fiberglass (0 °C to 260 °C, 32 °F to 500 °F), 2 m