

N-channel 600 V, 330 mΩ typ., 7 A, MDmesh M6 Power MOSFET in a PowerFLAT 5x6 HV package

PowerFLAT 5x6 HV

AM15540v7

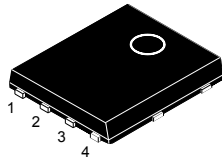
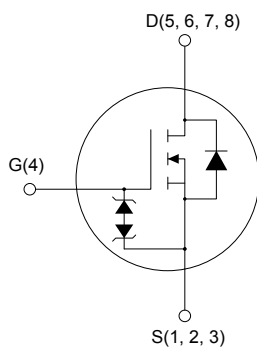

Features

Order code	V_{DS}	$R_{DS(on)}$ max.	I_D	P_{TOT}
STL13N60M6	600 V	415 mΩ	7 A	52 W

- Reduced switching losses
- Lower $R_{DS(on)}$ per area vs previous generation
- Low gate input resistance
- 100% avalanche tested
- Zener-protected

Applications

- Switching applications
- LLC converters
- Boost PFC converters

Description

The new MDmesh M6 technology incorporates the most recent advancements to the well-known and consolidated MDmesh family of SJ MOSFETs. STMicroelectronics builds on the previous generation of MDmesh devices through its new M6 technology, which combines excellent $R_{DS(on)}$ per area improvement with one of the most effective switching behaviors available, as well as a user-friendly experience for maximum end-application efficiency.

Product status link

[STL13N60M6](#)

Product summary

Order code	STL13N60M6
Marking	13N60M6
Package	PowerFLAT™ 5x6 HV
Packing	Tape and reel

1 Electrical ratings

Table 1. Absolute maximum ratings

Symbol	Parameter	Value	Unit
V_{GS}	Gate-source voltage	± 25	V
I_D	Drain current (continuous) at $T_{case} = 25\text{ }^\circ\text{C}$	7	A
	Drain current (continuous) at $T_{case} = 100\text{ }^\circ\text{C}$	4.5	
$I_{DM}^{(1)}$	Drain current (pulsed)	28	A
P_{TOT}	Total power dissipation at $T_{case} = 25\text{ }^\circ\text{C}$	52	W
$I_{AR}^{(2)}$	Avalanche current, repetitive or not repetitive	2	A
$E_{AS}^{(3)}$	Single pulse avalanche energy	140	mJ
$dv/dt^{(4)}$	Peak diode recovery voltage slope	15	V/ns
$dv/dt^{(5)}$	MOSFET dv/dt ruggedness	100	
T_{stg}	Storage temperature range	-55 to 150	$^\circ\text{C}$
T_j	Operating junction temperature range		

1. Pulse width is limited by safe operating area.
2. Pulse width limited by T_{jmax} .
3. Starting $T_j = 25\text{ }^\circ\text{C}$, $I_D = I_{AR}$, $V_{DD} = 50\text{ V}$.
4. $I_{SD} \leq 7\text{ A}$, $di/dt = 400\text{ A}/\mu\text{s}$, $V_{DS(peak)} < V_{(BR)DSS}$, $V_{DD} = 400\text{ V}$
5. $V_{DS} \leq 480\text{ V}$

Table 2. Thermal data

Symbol	Parameter	Value	Unit
$R_{thj-case}$	Thermal resistance junction-case	2.4	$^\circ\text{C}/\text{W}$
$R_{thj-pcb}^{(1)}$	Thermal resistance junction-pcb	50	

1. When mounted on an 1-inch² FR-4, 2 Oz copper board.

2 Electrical characteristics

($T_{\text{case}} = 25\text{ }^{\circ}\text{C}$ unless otherwise specified)

Table 3. Static

Symbol	Parameter	Test conditions	Min.	Typ.	Max.	Unit
$V_{(\text{BR})\text{DSS}}$	Drain-source breakdown voltage	$V_{\text{GS}} = 0\text{ V}$, $I_{\text{D}} = 1\text{ mA}$	600			V
I_{DSS}	Zero gate voltage drain current	$V_{\text{GS}} = 0\text{ V}$, $V_{\text{DS}} = 600\text{ V}$			1	μA
		$V_{\text{GS}} = 0\text{ V}$, $V_{\text{DS}} = 600\text{ V}$, $T_{\text{case}} = 125\text{ }^{\circ}\text{C}$ ⁽¹⁾			100	
I_{GSS}	Gate-body leakage current	$V_{\text{DS}} = 0\text{ V}$, $V_{\text{GS}} = \pm 25\text{ V}$			± 5	μA
$V_{\text{GS(th)}}$	Gate threshold voltage	$V_{\text{DS}} = V_{\text{GS}}$, $I_{\text{D}} = 250\text{ }\mu\text{A}$	3.25	4	4.75	V
$R_{\text{DS(on)}}$	Static drain-source on-resistance	$V_{\text{GS}} = 10\text{ V}$, $I_{\text{D}} = 3.5\text{ A}$		330	415	$\text{m}\Omega$

1. Defined by design, not subject to production test.

Table 4. Dynamic

Symbol	Parameter	Test conditions	Min.	Typ.	Max.	Unit
C_{iss}	Input capacitance		-	509	-	pF
C_{oss}	Output capacitance	$V_{\text{DS}} = 100\text{ V}$, $f = 1\text{ MHz}$, $V_{\text{GS}} = 0\text{ V}$	-	34.4	-	
C_{riss}	Reverse transfer capacitance		-	4.2	-	
$C_{\text{oss eq.}}^{(1)}$	Equivalent output capacitance	$V_{\text{DS}} = 0\text{ to }480\text{ V}$, $V_{\text{GS}} = 0\text{ V}$	-	94	-	pF
R_{G}	Intrinsic gate resistance	$f = 1\text{ MHz}$, $I_{\text{D}} = 0\text{ A}$	-	5.6	-	Ω
Q_{g}	Total gate charge	$V_{\text{DD}} = 480\text{ V}$, $I_{\text{D}} = 10\text{ A}$, $V_{\text{GS}} = 0\text{ to }10\text{ V}$ (see Figure 14. Test circuit for gate charge behavior)	-	13	-	nC
Q_{gs}	Gate-source charge		-	3.4	-	
Q_{gd}	Gate-drain charge		-	6.4	-	

1. $C_{\text{oss eq.}}$ is defined as a constant equivalent capacitance giving the same charging time as C_{oss} when V_{DS} increases from 0 to 80% V_{DSS} .

Table 5. Switching times

Symbol	Parameter	Test conditions	Min.	Typ.	Max.	Unit
$t_{\text{d(on)}}$	Turn-on delay time	$V_{\text{DD}} = 300\text{ V}$, $I_{\text{D}} = 5\text{ A}$, $R_{\text{G}} = 4.7\text{ }\Omega$, $V_{\text{GS}} = 10\text{ V}$	-	15.8	-	ns
t_{r}	Rise time		-	6.5	-	
$t_{\text{d(off)}}$	Turn-off delay time	(see Figure 13. Test circuit for resistive load switching times and Figure 18. Switching time waveform)	-	25.5	-	
t_{f}	Fall time		-	9.4	-	

Table 6. Source-drain diode

Symbol	Parameter	Test conditions	Min.	Typ.	Max.	Unit
I_{SD}	Source-drain current		-		7	A
$I_{SDM}^{(1)}$	Source-drain current (pulsed)		-		28	A
$V_{SD}^{(2)}$	Forward on voltage	$V_{GS} = 0\text{ V}$, $I_{SD} = 7\text{ A}$	-		1.6	V
t_{rr}	Reverse recovery time	$I_{SD} = 10\text{ A}$, $di/dt = 100\text{ A}/\mu\text{s}$, $V_{DD} = 60\text{ V}$	-	182		ns
Q_{rr}	Reverse recovery charge		-	1.35		μC
I_{RRM}	Reverse recovery current	(see Figure 15. Test circuit for inductive load switching and diode recovery times)	-	14.8		A
t_{rr}	Reverse recovery time	$I_{SD} = 10\text{ A}$, $di/dt = 100\text{ A}/\mu\text{s}$, $V_{DD} = 60\text{ V}$, $T_j = 150\text{ }^\circ\text{C}$	-	253		ns
Q_{rr}	Reverse recovery charge		-	2		μC
I_{RRM}	Reverse recovery current		(see Figure 15. Test circuit for inductive load switching and diode recovery times)	-	16	

1. Pulse width is limited by safe operating area.
2. Pulse test: pulse duration = 300 μs , duty cycle 1.5%.

2.1 Electrical characteristics (curves)

Figure 1. Safe operating area

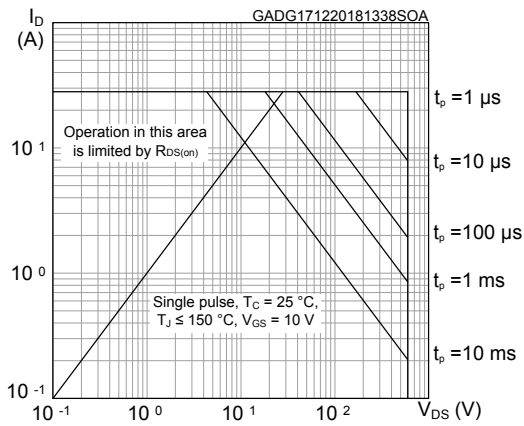

Figure 2. Thermal impedance

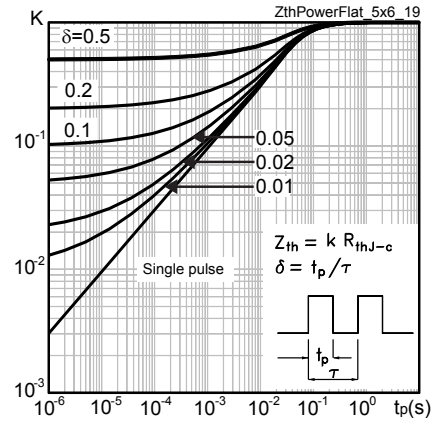

Figure 3. Output characteristics

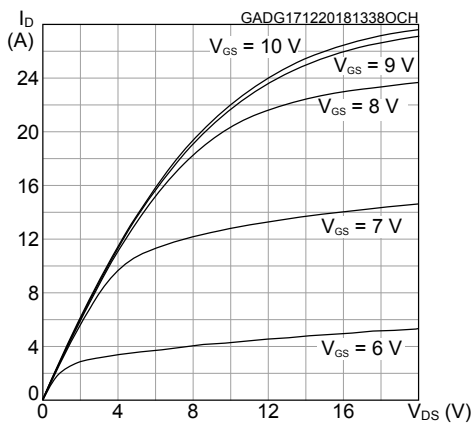

Figure 4. Transfer characteristics

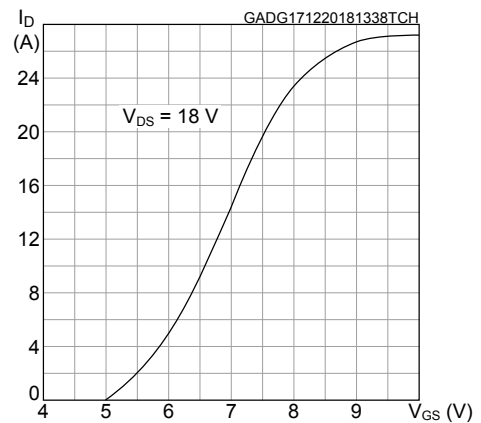

Figure 5. Gate charge vs gate-source voltage

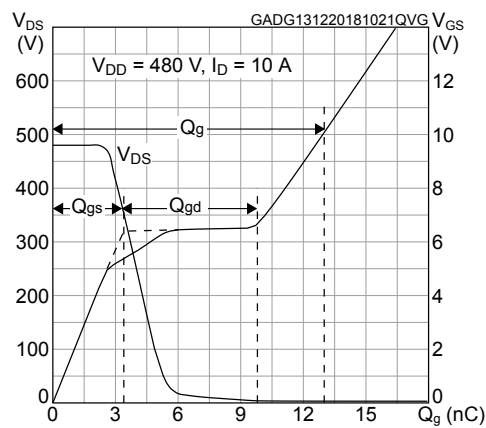

Figure 6. Static drain-source on-resistance

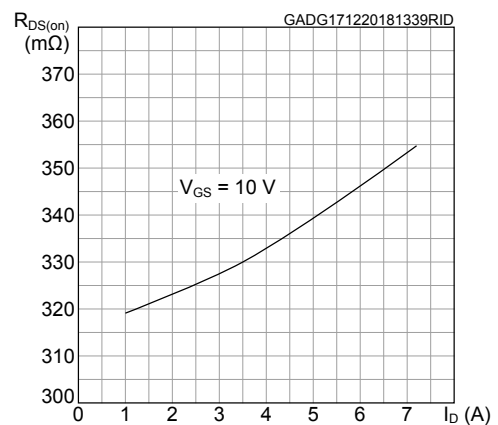

Figure 7. Capacitance variations

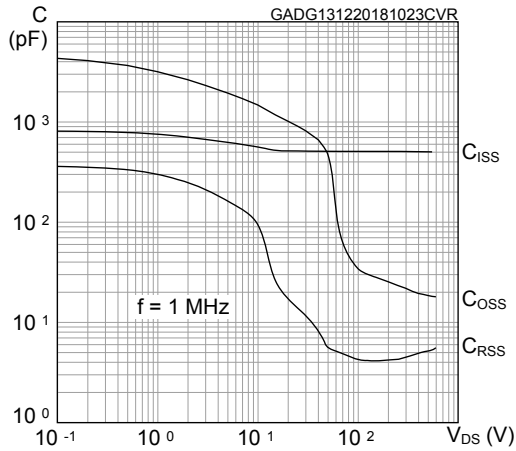

Figure 8. Output capacitance stored energy

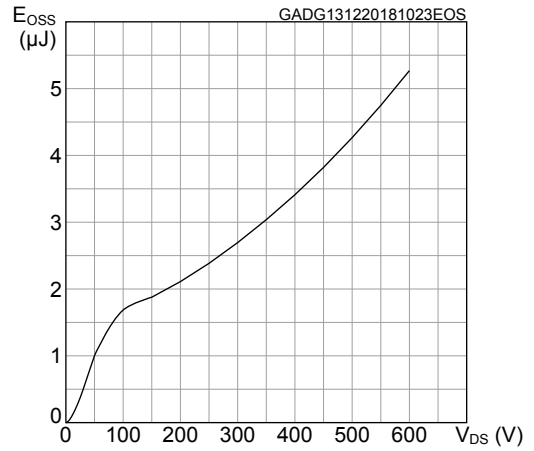

Figure 9. Normalized gate threshold voltage vs temperature

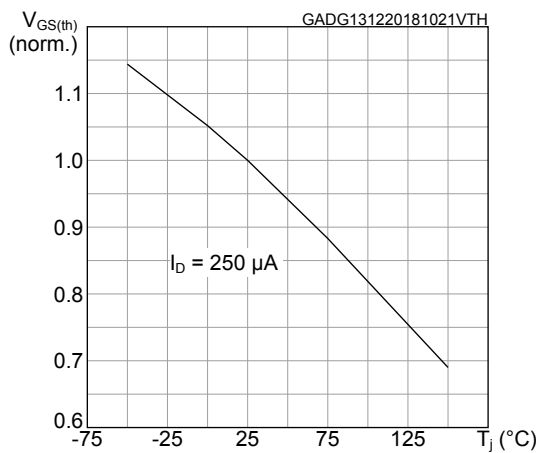

Figure 10. Normalized on-resistance vs temperature

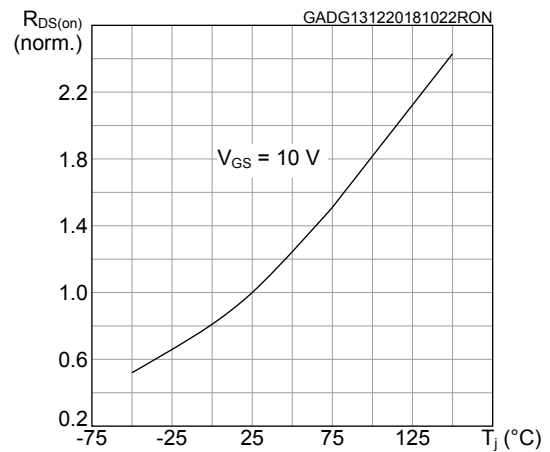

Figure 11. Normalized V_(BR)DSS vs temperature

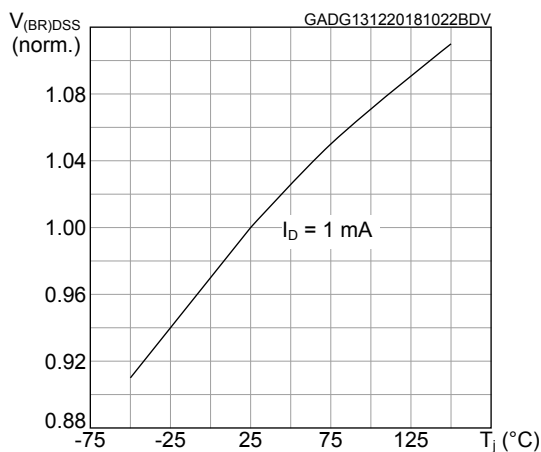
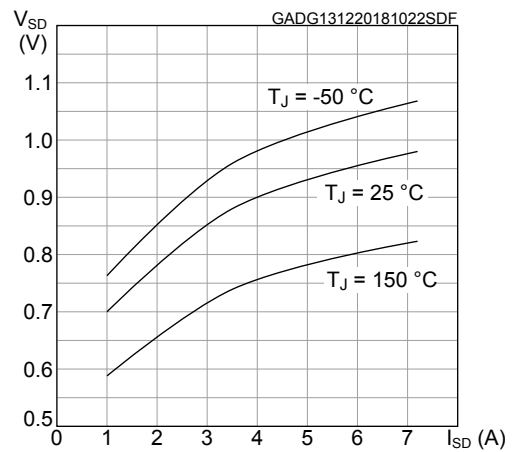
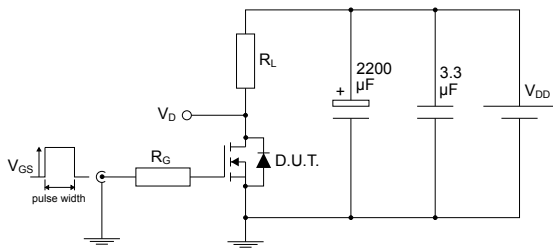

Figure 12. Source-drain diode forward characteristics



3 Test circuits

Figure 13. Test circuit for resistive load switching times

AM01468v1

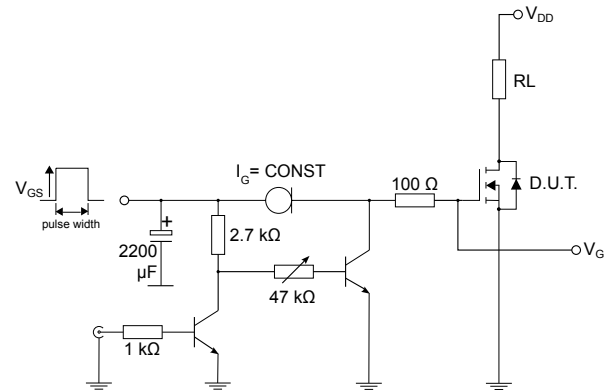
Figure 14. Test circuit for gate charge behavior

AM01469v10

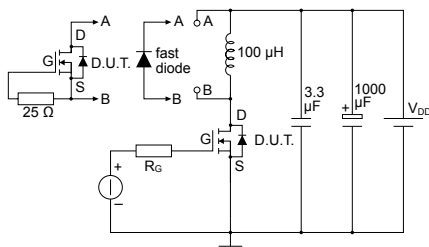
Figure 15. Test circuit for inductive load switching and diode recovery times

AM01470v1

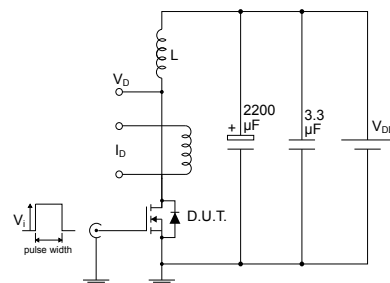
Figure 16. Unclamped inductive load test circuit

AM01471v1

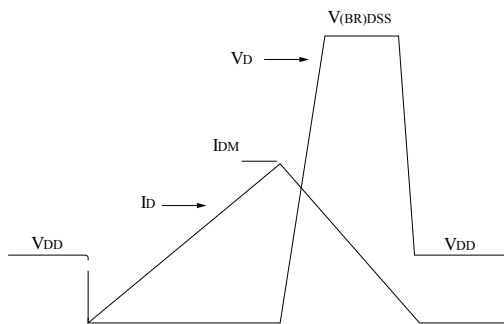
Figure 17. Unclamped inductive waveform

AM01472v1

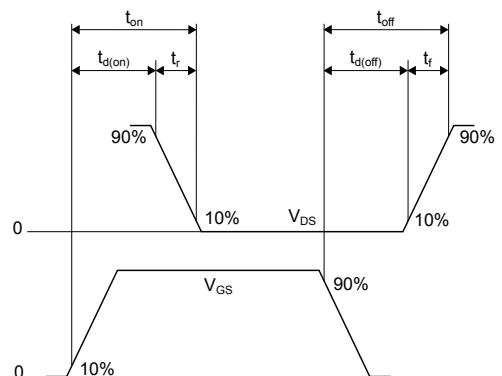
Figure 18. Switching time waveform

AM01473v1

4 Package information

In order to meet environmental requirements, ST offers these devices in different grades of **ECOPACK** packages, depending on their level of environmental compliance. ECOPACK specifications, grade definitions and product status are available at: www.st.com. ECOPACK is an ST trademark.

4.1 PowerFLAT 5x6 HV package information

Figure 19. PowerFLAT 5x6 HV package outline

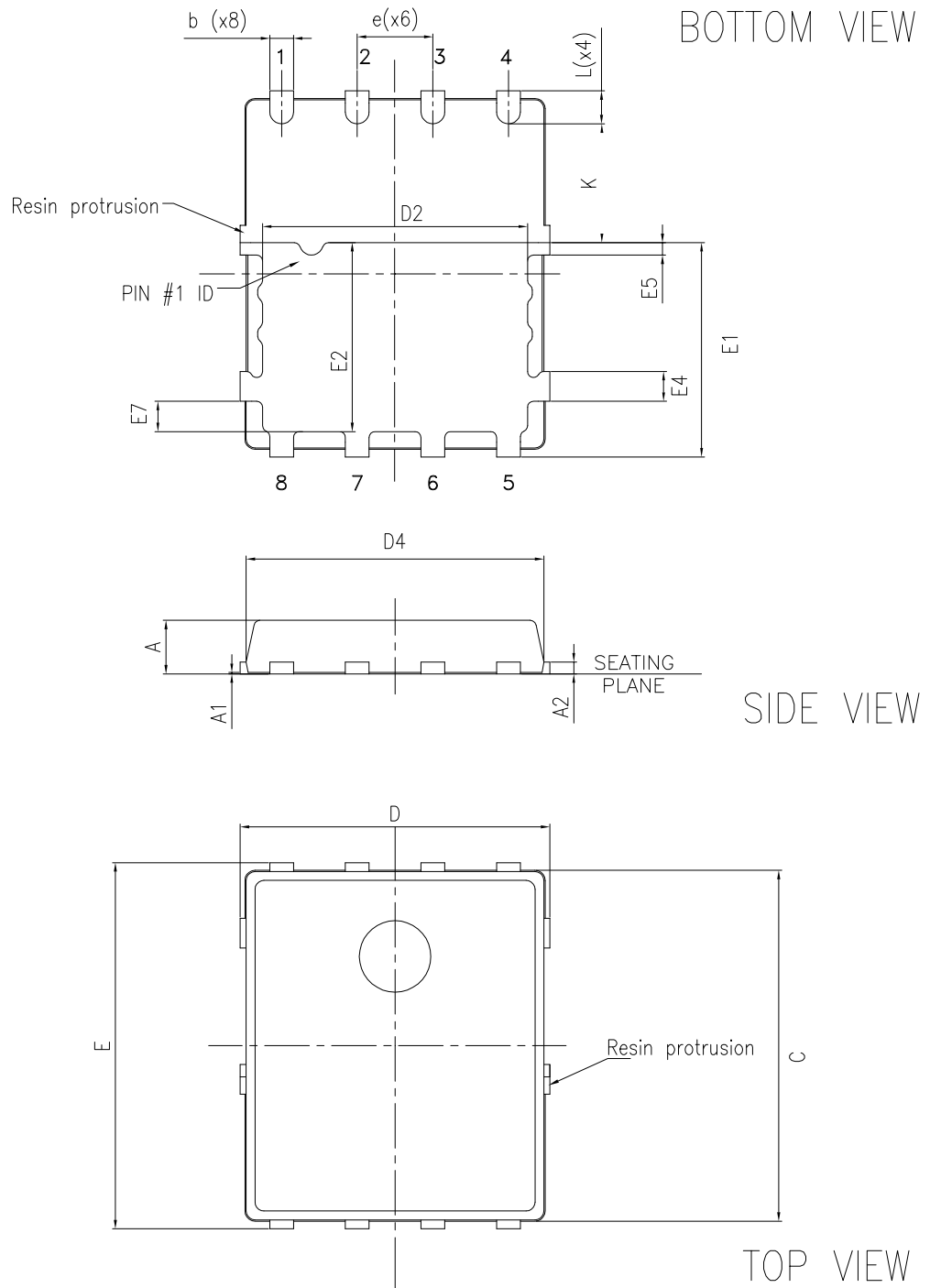

8368143_Rev_4

Table 7. PowerFLAT 5x6 HV mechanical data

Dim.	mm		
	Min.	Typ.	Max.
A	0.80		1.00
A1	0.02		0.05
A2		0.25	
b	0.30		0.50
C	5.60	5.80	6.00
D	5.10	5.20	5.30
D2	4.30	4.40	4.50
D4	4.60	4.80	5.00
E	6.05	6.15	6.25
E1	3.50	3.60	3.70
E2	3.10	3.20	3.30
E4	0.40	0.50	0.60
E5	0.10	0.20	0.30
E7	0.40	0.50	0.60
e		1.27	
L	0.50	0.55	0.60
K	1.90	2.00	2.10

Figure 20. PowerFLAT™ 5x6 HV recommended footprint (dimensions are in mm)

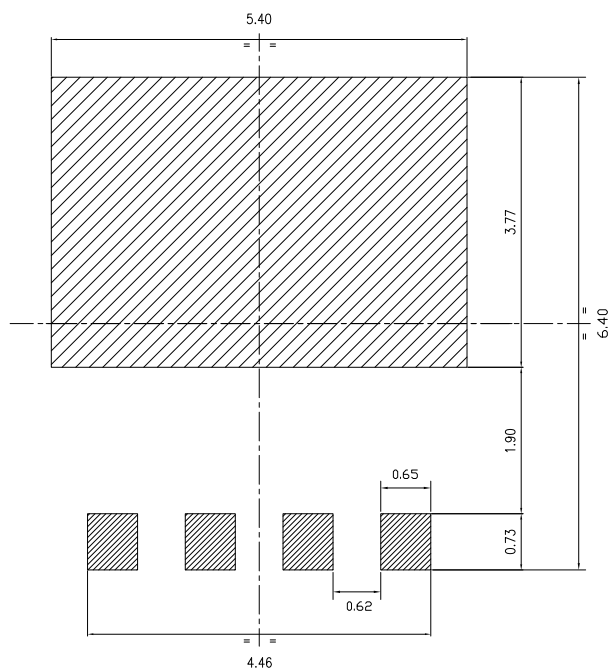

8368143_Rev_4_footprint

4.2 PowerFLAT 5x6 packing information

Figure 21. PowerFLAT 5x6 tape (dimensions are in mm)

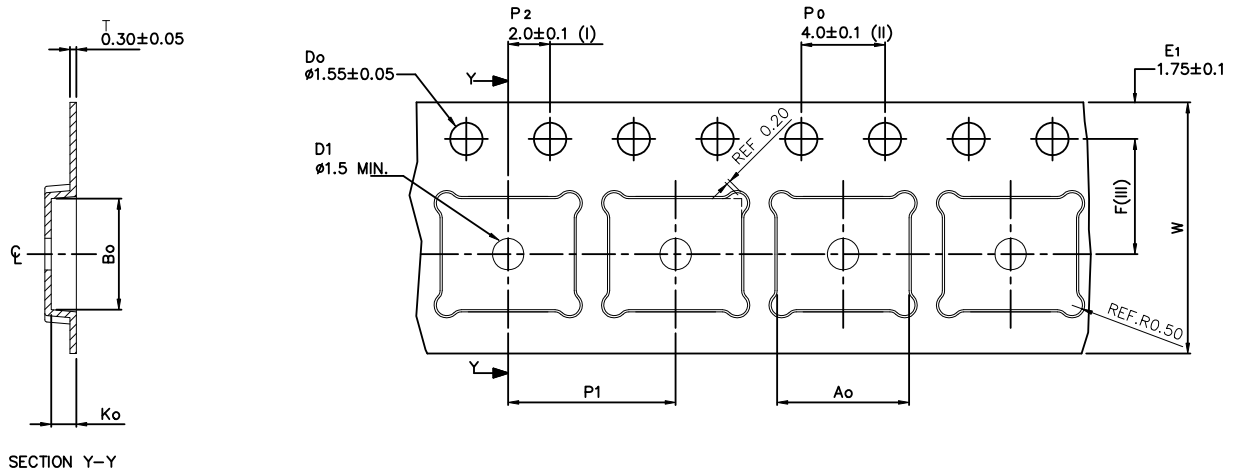

A ₀	6.30 +/- 0.1
B ₀	5.30 +/- 0.1
K ₀	1.20 +/- 0.1
F	5.50 +/- 0.1
P ₁	8.00 +/- 0.1
W	12.00 +/- 0.3

(I) Measured from centreline of sprocket hole to centreline of pocket.

(II) Cumulative tolerance of 10 sprocket holes is ± 0.20 .

(III) Measured from centreline of sprocket hole to centreline of pocket

Base and bulk quantity 3000 pcs
All dimensions are in millimeters

8234350_Tape_rev_C

Figure 22. PowerFLAT 5x6 package orientation in carrier tape

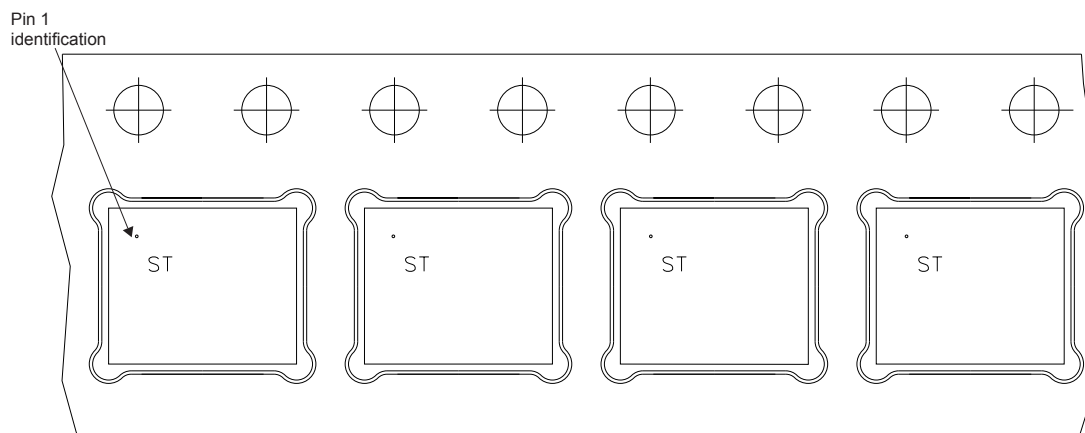
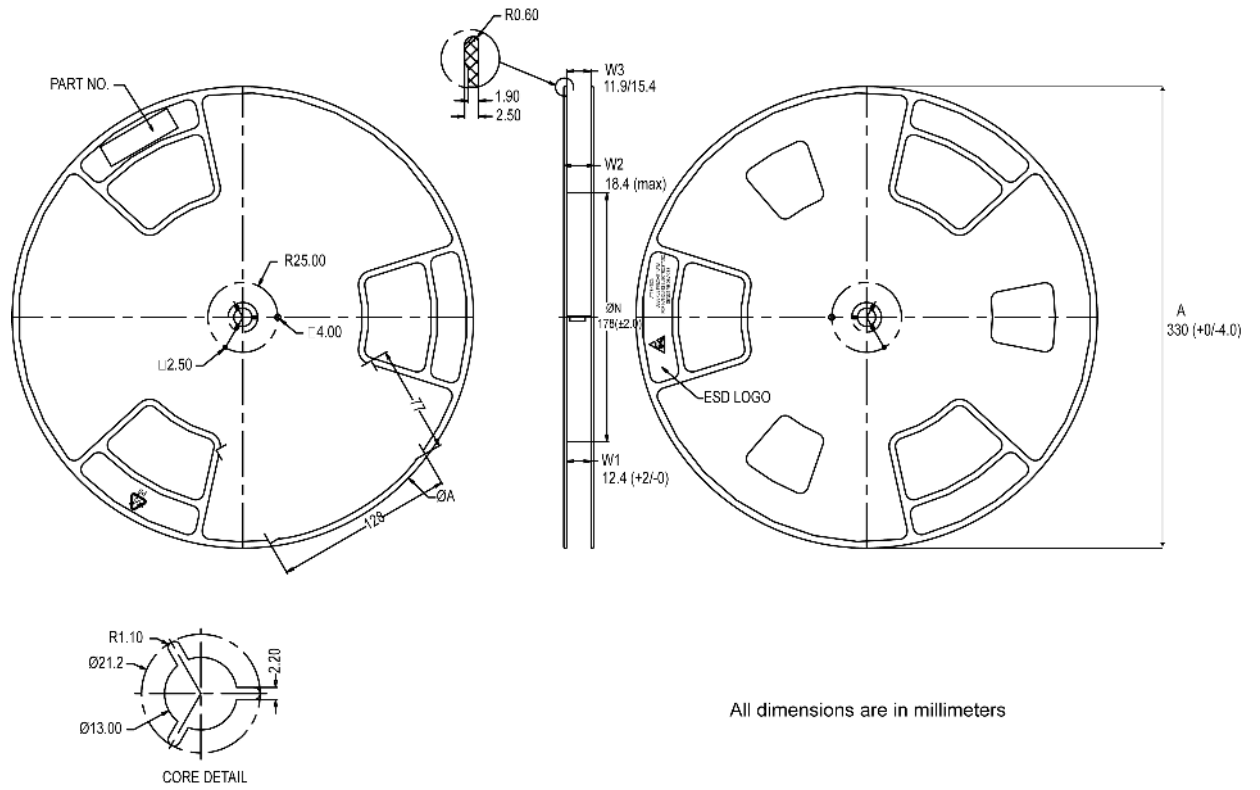

Figure 23. PowerFLAT 5x6 reel



8234350_Reel_rev_C

Revision history

Table 8. Document revision history

Date	Version	Changes
18-Dec-2018	1	First release.
20-May-2019	2	Updated Table 3. Static . Updated Figure 14. Test circuit for gate charge behavior . Minor text changes.

Contents

1	Electrical ratings	2
2	Electrical characteristics	3
2.1	Electrical characteristics (curves)	5
3	Test circuits	7
4	Package information	8
4.1	PowerFLAT 5x6 HV package information	8
4.2	PowerFLAT 5x6 packing information	10
	Revision history	13

IMPORTANT NOTICE – PLEASE READ CAREFULLY

STMicroelectronics NV and its subsidiaries (“ST”) reserve the right to make changes, corrections, enhancements, modifications, and improvements to ST products and/or to this document at any time without notice. Purchasers should obtain the latest relevant information on ST products before placing orders. ST products are sold pursuant to ST’s terms and conditions of sale in place at the time of order acknowledgement.

Purchasers are solely responsible for the choice, selection, and use of ST products and ST assumes no liability for application assistance or the design of Purchasers’ products.

No license, express or implied, to any intellectual property right is granted by ST herein.

Resale of ST products with provisions different from the information set forth herein shall void any warranty granted by ST for such product.

ST and the ST logo are trademarks of ST. For additional information about ST trademarks, please refer to www.st.com/trademarks. All other product or service names are the property of their respective owners.

Information in this document supersedes and replaces information previously supplied in any prior versions of this document.

© 2019 STMicroelectronics – All rights reserved