

# TE Connectivity DEUTSCH DJT Series MIL-DTL-38999 Series I Connectors



## INTERMATEABLE WITH SOURIAU CONNECTORS AND ALL MIL-DTL-38999 SERIES I

TE DEUTSCH DJT series MIL-DTL-38999 series I connectors offer high density contact arrangements in a miniature metal circular connector. DJT connectors meet MIL-38999 and were originally designed as military and aerospace components. The TE DEUTSCH DJT series is now being used in many applications requiring extremely reliable interconnections. These TE DEUTSCH connectors are quick-mating, environmentally-sealed, triple-lead threaded, have a self-locking coupling, and are EMI-RFI-shielded. A variety of D38999 backshells are available. For full product details on the TE DEUTSCH DJT series MIL-DTL-38999 series I connectors, please see the specifications below.

### APPLICATIONS

- High-performance military aircraft
- Commercial aircraft
- Communications equipment
- Armored personnel carriers & tanks
- High temperature industrial equipment
- Missiles
- Shipboard

### FEATURES

- High Reliability
- Outstanding EMI/RFI Shielding Protection
- High Density
- Self Locking Connector Systems
- MIL-DTL-38999
- Scoop-Proof Contact Protection

**MATERIALS AND FINISHES**

Shell	Aluminium alloy
Bayonet Pins	Passivated stainless steel per QQ-S-763
Shell Plating	Electroless nickel and olive drab chromate over nickel
Contacts	Copper alloy
Contact Platings	50u" gold plated
Insulator	Rigid plastic dielectric
Seals	Fluorinated silicone based elastomer
Grounding Springs	Beryllium copper

**ELECTRICAL DATA**

Wire Range Sizes	12-28AWG
Insulation Resistance	5000 Megaohms minimum at 77°F (25°C)

Contact Resistance of mated contacts end to end

CONTACT SIZE	MAXIMUM MILLIVOLT DROP
22D	40
20	35
16	25
12	25

Test Voltage ac rms

SERVICE RATING	SEA LEVEL		100,000 FEET ALTITUDE	
	MATED	UNMATED	MATED	UNMATED
M	1300	1300	800	200
N	1000	1000	600	200
I	1800	1800	1000	200
II	2300	2300	1000	200

Operating Voltage

	SERVICE RATING			
	N	M	I	II
Operating Voltage	300VAC/450VDC	400VAC/500VDC	600VAC/850VDC	900VAC/1250VDC

Current Rating

WIRE SIZE	CONTACT SIZE	MAX. CURRENT FOR TEST IN AMPS	POTENTIAL DROP MILLIVOLT AT 77°F (25°C)
24	20	3	<45
20	20	7.5	<55
20	16	7.5	<45
16	16	13	<50
14	12	17	<45
12	12	23	<50

**MECHANICAL DATA**

Operating Temperature	B - Olive Drab -65°C to +175°C (-85°F to +347°F) F - Electroless Nickel -65°C to +200°C (-85°F to +392°F)
Sealing	Against sand, dust per MIL-STD-202 & ice resistance

Wire Sealing Range

CONTACT SIZE	MINIMUM		MAXIMUM	
	INCHES	MM	INCHES	MM
22D	0.030	0.76	0.054	1.37
20	0.040	1.02	0.83	2.11
16	0.065	1.65	0.109	2.77
12	0.097	2.46	0.142	3.61
8 (Coax)	0.135	3.43	0.155	3.94
8 (Twinax)	0.124	3.15	0.134	3.4

Insulation Strip Length

CONTACT SIZE	STRIP LENGTH	
	INCHES	MM
22D	0.125	3.18
20	0.188	4.77
16	0.188	4.77
12	0.188	4.77

Mating Life	500 mating cycle
Salt Spray	B - Olive Drab, 500 hours per MIL-STD-1344A method 1001 condition C F - Electroless Nickel, 48 hours per MIL-STD-1344A method 1001 condition B
Temp Durability	B - Olive Drab -65°C to +175°C (-85°F to +347°F) F - Electroless Nickel -65°C to +200°C (-85°F to +392°F)
Chemical Resistance	Lubricating oils, hydraulic fluids, coolants, deicing fluids per MIL-STD-1344A Method 1016 condition a-1
Sine Vibration	60g at -55°C per MIL-DTL-38999L 4.5.23.2.1
Random Vibration	49.5 grms at ambient temperatures
Shock	300 grms
EMI Shielding Effectiveness	100 MHz to 10 GHz - minimum attenuation of 50dB
Contact Type	Crimp, fiber optic, coax, twinax, or printed circuit
Number of Circuits	2 to 128
Contact Insertion	Rear Insertion/Rear Extraction with simple plastic or high quality metal hand tools.
Polarization	Five keyways with optional master keyway rotations (Note insert and main keyways remain fixed)
Approvals	MIL-DTL-38999

Contact Retention

CONTACT SIZE	RETENTION AXIAL LOAD +/-10 PERCENT		SEPARATION FORCE MINIMUM (INITIAL)	
	NEWTONS	LBS.	NEWTONS	OUNCES
22D	44	10	0.19	0.7
20	15	67	0.19	0.7
16	25	111	0.56	2
12	25	111	0.83	3
8	25	111	1.39	5
8 Twinax	25	111	1.39	5

## HOW TO ORDER DJT SERIES CONNECTORS - MILITARY

<b>1</b>	<b>2</b>	<b>3A</b>	<b>4</b>	<b>3B</b>	<b>5</b>	<b>6</b>	<b>7</b>
<b>MS27468</b>	<b>T</b>	<b>25</b>	<b>F</b>	<b>35</b>	<b>P</b>		<b>-LC</b>
<b>SHELL STYLE</b>	<b>CLASS</b>	<b>SIZE</b>	<b>PLATING</b>	<b>LAYOUT</b>	<b>CONTACT</b>	<b>POLARIZATION</b>	<b>MODIFIER</b>
<small>(Military part number example)</small>						<small>(OMIT FOR NORMAL)</small>	

### STEP 1: SELECT SHELL STYLE, PLUG OR RECEPTACLE



### STEP 2: SELECT CLASS

T = No Rear Accessories
P = Potting Ring & Cup

Available with PC pins. Contact us for more details.

### STEP 3: SELECT LAYOUT

⇨ See page 52 for listing by # of contacts

NUMBER	RATING	TOTAL	22D	20	16	12
9-35	M	6	6			
9-98	I	3		3		
11-5	I	5		5		
11-35	M	13	13			
11-99	I	7		7		
13-4	I	4			4	
13-35	M	22	22			
13-98	I	10		10		
15-5	II	5			5	
15-18	I	18		18		
15-35	M	37	37			
15-97	I	12		8	4	
17-6	I	6				6
17-8	II	8			8	
17-26	I	26		26		
17-35	M	55	55			
19-11	II	11			11	
19-32	I	32		32		
19-35	M	66	66			
21-11	I	11				11
21-16	II	16			16	
21-35	M	79	79			
21-41	I	41		41		
23-21	II	21			21	
23-35	M	100	100			
23-53	I	53		53		
23-55	I	55		55		
25-4	I	56		48	8	
25-19	I	19				19
25-24	I	24			12	12
25-29	I	29			29	
25-35	M	128	128			
25-61	I	61		61		

WHEN CHOOSING LAYOUT First Number = Step 3A – Shell Size, Second Number = 3B – Layout

**STEP 4: SELECT PLATING**



- B** = Olive Drab Chromate over Cadmium over Electroless Nickel -65°C to 175°C (-85°F to 347°F)
- F** = Electroless Nickel -65°C to 200°C (-85°F to 392°F)

**STEP 5: SELECT CONTACT**



- P** = Pin
- S** = Socket
- H** = 1500 cycle Pin contacts
- J** = 1500 cycle Socket contacts
- Note:** See Step 7 if you are not ordering contacts with part.
  
- A** = Less Pin Contacts
- B** = Less Socket Contact
- May be used for special contact types (PC Pin, Thermocouple, Fiber optic).

**STEP 6: SELECT POLARIZATION**



- Omit for normal
- A** = Next Most Popular
- B** = Limited Availability
- C** = Check for Availability
- D** = Check for Availability

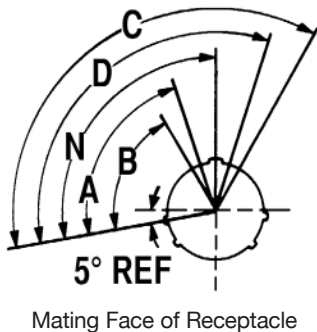

SHELL SIZE	N	A	B	C	D
9	95	77	-	-	113
11	95	81	67	123	109
13	95	75	63	127	115
15	95	74	61	129	116
17	95	77	65	125	113
19	95	77	65	125	113
21	95	77	65	125	113
23	95	80	69	121	110
25	95	80	69	121	110

**STEP 7: SELECT MODIFIER**



- Omit for standard contacts
- LC** = less contacts, wire hole fillers and plastic insertion/extraction tool. (Purchase Order must state Less Contacts)
- Note:** -LC is not marked on part

HOW TO ORDER DJT SERIES CONNECTORS - COMMERCIAL

<b>1</b>	<b>2</b>	<b>3</b>	<b>4</b>	<b>5</b>	<b>6</b>
<b>DJT14</b>	<b>E</b>	<b>25-35</b>	<b>P</b>	<b>N</b>	<b>-LC</b>
<b>SHELL STYLE</b>	<b>PLATING</b>	<b>LAYOUT</b>	<b>CONTACT</b>	<b>POLARIZATION</b>	<b>MODIFIER</b>

(Commercial part number example)

**STEP 1: SELECT SHELL STYLE, PLUG OR RECEPTACLE**



**STEP 2: SELECT PLATING**

- E** = Olive Drab Chromate over Cadmium over Electroless Nickel -65°C to 175°C (-85°F to 347°F)
- F** = Electroless Nickel -65°C to 200°C (-85°F to 392°F)

**STEP 3: SELECT LAYOUT**

⇒ See page 52 for listing by # of contacts

NUMBER	RATING	TOTAL	22D	20	16	12
9-35	M	6	6			
9-98	I	3		3		
11-5	I	5		5		
11-35	M	13	13			
11-99	I	7		7		
13-4	I	4			4	
13-35	M	22	22			
13-98	I	10		10		
15-5	II	5			5	
15-18	I	18		18		
15-35	M	37	37			
15-97	I	12		8	4	
17-6	I	6				6
17-8	II	8			8	
17-26	I	26		26		
17-35	M	55	55			
19-11	II	11			11	
19-32	I	32		32		
19-35	M	66	66			
21-11	I	11				11
21-16	II	16			16	
21-35	M	79	79			
21-41	I	41		41		
23-21	II	21			21	
23-35	M	100	100			
23-53	I	53		53		
23-55	I	55		55		
25-4	I	56		48	8	
25-19	I	19				19
25-24	I	24			12	12
25-29	I	29			29	
25-35	M	128	128			
25-61	I	61		61		

**STEP 4: SELECT CONTACT**



- P** = Pin
- S** = Socket
- H** = 1500 cycle Pin contacts
- J** = 1500 cycle Socket contacts
- Note:** See Step 7 if you are not ordering contacts with part.
  
- A** = Less Pin Contacts
- B** = Less Socket Contact
- May be used for special contact types (PC Pin, Thermocouple, Fiber optic).

**STEP 5: SELECT POLARIZATION**



- N** = Normal Standard
- A** = Next Most Popular
- B** = Limited Availability
- C** = Check for Availability
- D** = Check for Availability

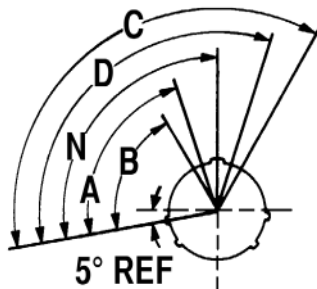

Mating Face of Receptacle

SHELL SIZE	N	A	B	C	D
9	95	77	-	-	113
11	95	81	67	123	109
13	95	75	63	127	115
15	95	74	61	129	116
17	95	77	65	125	113
19	95	77	65	125	113
21	95	77	65	125	113
23	95	80	69	121	110
25	95	80	69	121	110

**STEP 6: SELECT MODIFIER**



For other commercial modification, i.e., less tools, with PC contact or with endbell, contact us.

- Omit for standard contacts
- LC** = less contacts, wire hole fillers and plastic insertion/extraction tool. (Purchase Order must state Less Contacts)
- Note:** LC is not marked on part

LAYOUTS BY NUMBER OF CONTACTS

•=22   ○=20   ◊=16   ▲=12   ⊕=8

LAYOUT	09-35	09-98	11-05	11-35	11-99	13-04	13-35
# OF CONTACTS	6 - #22	3 - #20	5 - #20	13 - #22	7 - #20	4 - #16	22 - #22
SERVICE RATING	M	I	I	M	I	I	M
LAYOUT	13-98	15-05	15-18	15-35	15-97*	17-06	17-08*
# OF CONTACTS	10 - #20	5 - #16	18 - #20	37 - #22	8 - #20, 4 - #16	6 - #12	8 - #16
SERVICE RATING	I	II	I	M	I	I	II
LAYOUT	17-26	17-35	19-11*	19-32	19-35	21-11*	21-16
# OF CONTACTS	26 - #20	55 - #22	11 - #16	32 - #20	66 - #22	11 - #12	16 - #16
SERVICE RATING	I	M	II	I	M	I	II
LAYOUT	21-41	21-35	23-21*	23-35*	23-53	23-55*	
# OF CONTACTS	41 - #20	79 - #22	21 - #16	100 - #22	53 - #20	55 - #20	
SERVICE RATING	I	M	II	M	I	I	
LAYOUT	25-04*	25-19*	25-24*	25-29*	25-35	25-61*	
# OF CONTACTS	48 - #20, 8 - #16	19 - #12	12 - #16, 12 - #12	29 - #16	128 - #22	61 - #20	
SERVICE RATING	I	I	I	I	M	I	



## PINS

CONTACT SIZE	WIRE CRIMP SIZE RANGE	PIN PART NUMBER	COLOR BANDS			WIRE STRIP LENGTHS		WIRE INSULATION SEALING RANGE				WIRE HOLE FILLER	WIRE HOLE FILLER COLOR
			1	2	3	IN.	MM	MIN. IN.	MIN. MM	MAX. IN.	MAX. MM		
22D	28,26,24,22	M39029/58-360	Orange	Blue	Black	0.125	3.18	0.030	0.760	0.054	1.37	MS27488-22-2	Black
20	24,22,20	M39029/58-363	Orange	Blue	Orange	0.188	4.77	0.040	1.020	0.083	2.11	MS27488-20-2	Red
16	20,18,16	M39029/58-364	Orange	Blue	Yellow	0.188	4.77	0.065	1.65	0.109	2.77	MS27488-16-2	Blue
12	14,12	M39029/58-365	Orange	Blue	Green	0.188	4.77	0.097	2.46	0.142	3.61	MS27488-12-2	Yellow

## SOCKETS

CONTACT SIZE	WIRE CRIMP SIZE RANGE	SOCKET PART NUMBER	COLOR BANDS			WIRE STRIP LENGTHS		WIRE INSULATION SEALING RANGE				WIRE HOLE FILLER	WIRE HOLE FILLER COLOR
			1	2	3	IN.	MM	MIN. IN.	MIN. MM	MAX. IN.	MAX. MM		
22D	28,26,24,22	M39029/56-348	Orange	Yellow	Gray	0.125	3.18	0.030	0.760	0.054	1.37	MS27488-22-2	Black
20	24,22,20	M39029/56-351	Orange	Green	Brown	0.188	4.77	0.040	1.020	0.083	2.11	MS27488-20-2	Red
16	20,18,16	M39029/56-352	Orange	Green	Red	0.188	4.77	0.065	1.65	0.109	2.77	MS27488-16-2	Blue
12	14,12	M39029/56-353	Orange	Green	Orange	0.188	4.77	0.097	2.46	0.142	3.61	MS27488-12-2	Yellow

CONTACT TOOLS

PINS



CONTACT SIZE	HAND CRIMP TOOL	TURRET HEAD (LOCATOR)	TURRET HEAD (LOCATOR) COLOR	POWER CRIMP TOOL	POWER TOOL LOCATOR	METAL		PLASTIC		
						INSERTION TOOL	EXTRACTION TOOL	INSERTION/ EXTRACTION TOOL	INSERTION TIP COLOR	EXTRACTION TIP COLOR
22D	M22520/2-01	M22520/2-09	-	WA22	M22520/2-09	MS27495A22M	MS27495A22M	M81969/14-01	Green	White
20	M22520/1-01	M22520/1-04	Red	WA27F	M22520/1-04	MS27495A20	MS27495A20	M81969/14-10	Red	Orange
16	M22520/1-01	M22520/1-04	Blue	WA27F	M22520/1-04	MS27495A16	MS27495A16	M81969/14-03	Blue	White
12	M22520/1-01	M22520/1-04	Yellow	WA27F	M22520/1-04	DAK95-12B	DRK95-12B	M81969/14-04	Yellow	White

SOCKETS

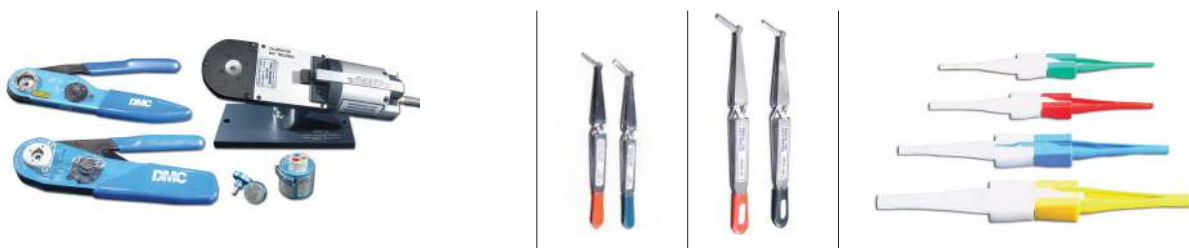

CONTACT SIZE	HAND CRIMP TOOL	TURRET HEAD (LOCATOR)	TURRET HEAD (LOCATOR) COLOR	POWER CRIMP TOOL	POWER TOOL LOCATOR	METAL		PLASTIC		
						INSERTION TOOL	EXTRACTION TOOL	INSERTION/ EXTRACTION TOOL	INSERTION TIP COLOR	EXTRACTION TIP COLOR
22D	M22520/2-01	M22520/2-09	-	WA22	M22520/2-09	MS27495A22M	MS27495A22M	M81969/14-01	Green	White
20	M22520/1-01	M22520/1-04	Red	WA27F	M22520/1-04	MS27495A20	MS27495A20	M81969/14-10	Red	Orange
16	M22520/1-01	M22520/1-04	Blue	WA27F	M22520/1-04	MS27495A16	MS27495A16	M81969/14-03	Blue	White
12	M22520/1-01	M22520/1-04	Yellow	WA27F	M22520/1-04	DAK95-12B	DRK95-12B	M81969/14-04	Yellow	White

PLUGS

MS27467/ DJT16

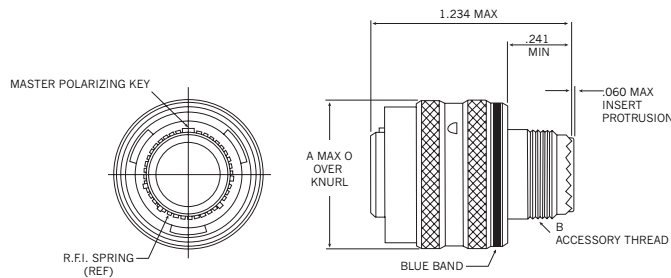

SHELL SIZE	A DIA. +/- .020 (+/- 0.51)	B THREAD UNEF-2A
9	0.859 (21.81)	0.4375-28
11	0.984 (24.99)	0.5625-24
13	1.156 (29.36)	0.6875-24
15	1.281 (32.53)	0.8125-20
17	1.406 (35.71)	0.9375-20
19	1.516 (38.50)	1.0625-18
21	1.641 (41.68)	1.1875-18
23	1.766 (44.85)	1.3125-18
25	1.891 (48.03)	1.4375-18

FLANGE MOUNT

MS27466/ DJT10

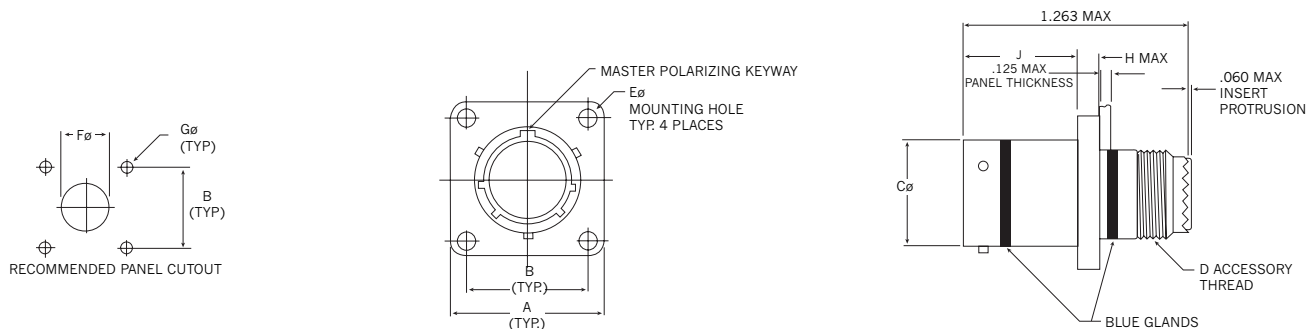

SHELL SIZE	A +/- .020 (+/- .508)	B +/- .005 (+/- .127)	C DIA. +/- .003 (+/- .076)	D THREAD UNEF-2A	E DIA. +.010/- .005 (+ .254/ -.127)	F DIA. MIN.	G DIA. +/- .005 (+/- .127)	H MAX.	J +.000/ -.005 (+ 0 / -.127)
9	0.938 (23.82)	0.719 (18.26)	0.570 (14.47)	0.4375-28	0.128 (3.25)	0.516 (13.10)	0.128 (3.25)	.100 (2.54)	0.632 (16.05)
11	1.031 (26.18)	0.812 (20.62)	0.698 (17.72)	0.5625-24	0.128 (3.25)	0.664 (16.86)	0.128 (3.25)	.100 (2.54)	0.632 (16.05)
13	1.125 (28.57)	0.906 (23.01)	0.848 (21.53)	0.6875-24	0.128 (3.25)	0.750 (19.05)	0.128 (3.25)	.100 (2.54)	0.632 (16.05)
15	1.219 (30.96)	0.969 (24.61)	0.973 (24.71)	0.8125-20	0.128 (3.25)	0.906 (23.01)	0.128 (3.25)	.100 (2.54)	0.632 (16.05)
17	1.312 (33.32)	1.062 (26.97)	1.098 (27.88)	0.9375-20	0.128 (3.25)	1.016 (25.80)	0.128 (3.25)	.100 (2.54)	0.632 (16.05)
19	1.438 (36.52)	1.156 (29.36)	1.205 (30.60)	1.0625-18	0.128 (3.25)	1.141 (28.98)	0.128 (3.25)	.100 (2.54)	0.632 (16.05)
21	1.562 (39.67)	1.250 (31.75)	1.330 (33.78)	1.1875-18	0.128 (3.25)	1.266 (32.15)	0.128 (3.25)	.130 (3.30)	0.602 (15.29)
23	1.688 (42.87)	1.375 (34.92)	1.455 (36.95)	1.3125-18	0.147 (3.73)	1.377 (34.97)	1.54 (39.11)	.130 (3.30)	0.602 (15.29)
25	1.812 (46.02)	1.500 (38.10)	1.580 (40.13)	1.4375-18	0.147 (3.73)	1.484 (37.69)	1.54 (39.11)	.130 (3.30)	0.602 (15.29)

All dimensions in inches (millimeters in parenthesis)

DIMENSIONS

JAM NUT RECEPTACLE

MS27484/ DJT14

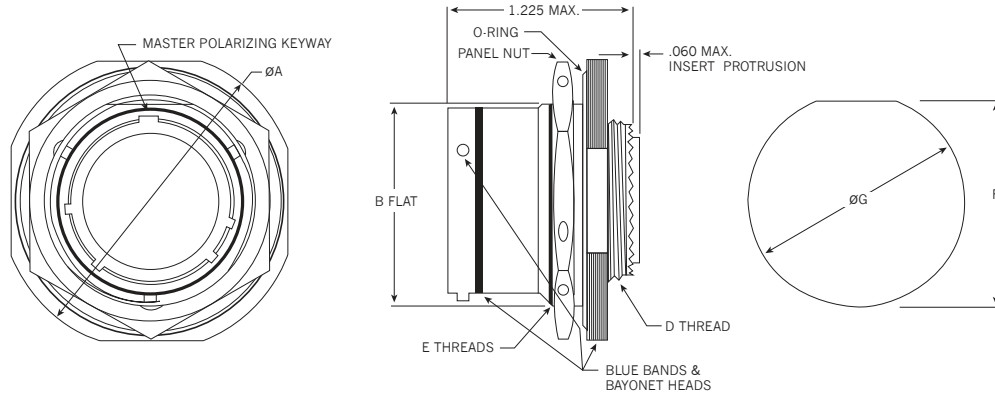

SHELL SIZE	A DIA. +/- .016 (+/- .406)	B FLAT + .000/- .010 (+.000/- .254)	D THREAD UNEF -2A	E THREAD UNEF -2A	F + .000/- .010 (+.000/- .254)	G DIA. + .000/- .010 (+.000/- .254)
9	1.188 (30.18)	0.655 (16.64)	0.4375-28	0.6875-24	0.670 (17.02)	0.700 (17.78)
11	1.375 (34.93)	0.755 (19.18)	0.5625-24	0.8125-20	0.771 (19.58)	0.825 (20.96)
13	1.500 (38.10)	0.942 (23.93)	0.6875-24	1.000-20	0.955 (24.26)	1.010 (25.65)
15	1.625 (41.28)	1.066 (27.08)	0.8125-20	1.1250-18	1.085 (27.60)	1.135 (28.83)
17	1.750 (44.45)	1.191 (30.25)	0.9375-20	1.2500-18	1.210 (30.73)	1.260 (32.00)
19	1.938 (49.23)	1.316 (33.43)	1.0625-18	1.3750-18	1.335 (33.91)	1.385 (35.18)
21	2.062 (52.37)	1.441 (36.60)	1.1875-18	1.5000-18	1.460 (37.08)	1.510 (38.35)
23	2.188 (55.58)	1.566 (39.78)	1.3125-18	1.6250-18	1.585 (40.26)	1.635 (41.53)
25	2.312 (58.72)	1.691 (42.95)	1.4375-18	1.7500-18	1.710 (43.43)	1.760 (44.70)

All dimensions in inches (millimeters in parenthesis)

DUMMY RECEPTACLES, DUST CAPS & PLUG CAPS

DJT	DUMMY RECEPTACLES	RECEPTACLE DUST CAPS		PLUG DUST CAP
		FOR FLANGED	FOR JAM NUT	
9	M38999/9-9B	MS27502**9C	MS27502**9N	MS27501**9C
11	M38999/9-11B	MS27502**11C	MS27502**11N	MS27501**11C
13	M38999/9-13B	MS27502**13C	MS27502**13N	MS27501**13C
15	M38999/9-15B	MS27502**15C	MS27502**15N	MS27501**15C
17	M38999/9-17B	MS27502**17C	MS27502**17N	MS27501**17C
19	M38999/9-19B	MS27502**19C	MS27502**19N	MS27501**19C
21	M38999/9-21B	MS27502**21C	MS27502**21N	MS27501**21C
23	M38999/9-23B	MS27502**23C	MS27502**23N	MS27501**23C
25	M38999/9-25B	MS27502**25C	MS27502**25N	MS27501**25C

\*\* Select Code for Plating

B = Olive Drab Chromate over Cadmium over Nickel

F = Electroless Nickel

A = Gold Iridite over Cadmium Nickel

C = Hard Anodized

CABLE CLAMPS

DJT	STRAIGHT LOW COST	RIGHT ANGLE LOW COST	CABLE RANGE			
			MIN		MAX	
			INCHES	MM	INCHES	MM
9	M85049/49-2-8**	M85049/47**8	0.098	2.49	0.234	5.94
11	M85049/49-2-10**	M85049/47**10	0.153	3.89	0.234	5.94
13	M85049/49-2-12**	M85049/47**12	0.190	4.83	0.328	8.33
15	M85049/49-2-14**	M85049/47**14	0.260	6.60	0.457	11.61
17	M85049/49-2-16**	M85049/47**16	0.283	7.19	0.614	15.60
19	M85049/49-2-18**	M85049/47**18	0.325	8.25	0.634	16.10
21	M85049/49-2-20**	M85049/47**20	0.343	8.71	0.698	17.73
23	M85049/49-2-22**	M85049/47**22	0.381	9.68	0.823	20.90
25	M85049/49-2-24**	M85049/47**24	0.418	10.62	0.853	21.67

\*\* Select Code for Plating







W = Olive Drab Chromate over Cadmium over Nickel

N = Electroless Nickel

A = Hard Anodized

All dimensions in inches (millimeters in parenthesis)

## STANDARD MIL-SPEC

MIL-SPEC PREFIX	SEALED	EMI/RFI	S = STRAIGHT A = 90 DEGREES B = 45 DEGREES	ENDBELL TYPE	DESCRIPTION
M85049/62 	Y	N	S	Heat Shrink Boot Adapters	Designed for use with straight or right angle shrink boots. A knurled rear section with a boot groove provide an excellent surface for the boot to grab the metal endbell. Available with lock wire and drain holes. ⇨ See Heat Shrink Boots on pages 168-169.
M85049/32 	N	N	S	Extender Backshell with cable clamp	Non-environmental, designed for use with jacketed cable, allows extra space to break out the wires and still provide strain relief clamping to the outside of the cable jacket.
M85049/17 	Y	Y	S	Environmental Shielded Endbell	This EMI/RFI shielding environmentally sealing endbell features a standard style cable clamp with gland seal at the end of and extender style backshell.
M85049/29 	N	Y	S	Non-Environmental Shielded Endbell	This EMI/RFI shielding non-environmentally sealing endbell features a standard style cable clamp.
M85049/85 M85049/86 M85049/87 	Y	Y	S B A	Banding Adapter	Banding adapters utilize a band of metal that fastens and grounds cable shields to the outside of endbells. This method of terminating shields has advantages in that they typically use tools to tighten trim the bands. These tools make the termination tight, repeatable, reworkable (if you make a mistake just cut the band off and start again) and facilitates service. Banding adapters help lower the total applied cost by having simpler designs that have fewer parts with uncomplicated assembly procedures.
M85049/27 	N	N	S	Compression Nut	Wire Seal Compression Nut

NOTE: If military-standard versions won't work for your applications, please contact us with your requirements.

## WIRE STRIPPING

Strip insulation from end of wire to be crimped. (See table for proper stripping dimensions.) Do not cut or damage wire strands.

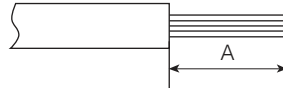

WIRE SIZE	A
22, 22M, 22D	.125 (3.18)
20	.188 (4.77)
16	.188 (4.77)
12	.188 (4.77)
10	.335 (8.51)
8 (power)	.470 (11.99)

## CONTACT CRIMPING

correct crimp



incorrect crimp



**STEP 1:** Strip wires. See above for correct strip length for contact. Insert wire into rear of contact. Wire insulation must push against rear of contact. Wire must be visible through inspection hole.

**STEP 2:** M22520 series crimp tool and locator is recommended. → See page 54 for choice of turret head and selection setting according to correct size, part number and wire gauge size.

**STEP 3:** Insert contact and wire into tool jaws. To crimp, squeeze handles together fully until ratchet releases and allows handles to expand; otherwise, contact cannot be extracted from tool jaws. Maintain slight insertion pressure on wire while crimping contact to wire.\*

## CONTACT INSERTION



**STEP 1:** Remove hardware from plug or receptacle and slip over wire bundle in proper order for reassembly.



**STEP 2:** Using proper plastic or metal insertion tool for corresponding contact, position wire in tip of the tool so that the tool tip presses against the contact shoulder.



**STEP 3:** Press tool against contact shoulder and, with firm and even pressure, insert wired contact and tool tip into center contact cavity.

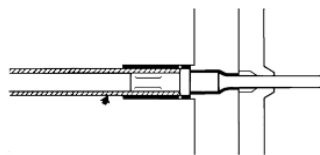

**STEP 4:** When contact bottoms, a slight "click" can be heard as tines of metal retaining clip snap into place behind contact shoulder.



**STEP 5:** Remove tool and pull back lightly on wire to make sure contact is properly seated. Repeat operation with remainder of contacts to be inserted, beginning with the center cavity and working outward in alternating rows.



**STEP 6:** After all contacts are inserted, fill any empty cavities with wire sealing plugs. Reassemble plug or receptacle hardware.

## ASSEMBLY INSTRUCTIONS



**STEP 1:** Remove hardware from plug or receptacle and slide hardware back along wire bundle.

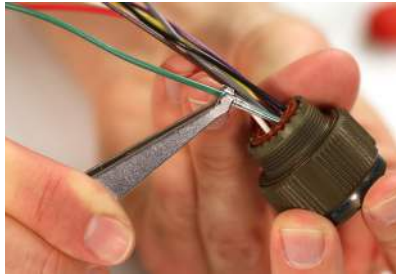

**STEP 2:** Using plastic or metal extraction tool with proper color code corresponding to contact size, place wire in tool.

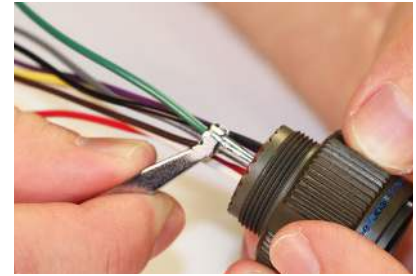

**STEP 3:** Insert tool into contact cavity until tool tip bottoms against the contact shoulder, expanding clip retaining lines.



**STEP 4:** Hold wire firmly in tool and extract wired contact and tool. Repeat operation for all contacts to be extracted.



**STEP 5:** Fill any empty cavities with wire sealing plugs. Reassemble plug or receptacle hardware.

Note: DTS series shown.