

1376073-2 ✓ ACTIVE

[Dynamic Series](#) | [Dynamic 2000 Series](#)

TE Internal #: 1376073-2

Housing, Housing for Male Terminals, Wire-to-Wire, 50 Position, .098 in [2.5 mm] Centerline, Crimp, 2 Row, Black, Dynamic 2000 Series

[View on TE.com >](#)



[Connectors](#) > [PCB Connectors](#) > [Wire-to-Board Connectors](#) > [Wire-to-Board Connector Assemblies & Housings](#) >

[Receptacle and Tab Housing: 2.5 mm Pitch, 250V](#)



Connector Product Type: **Housing**

Connector & Housing Type: **Housing for Male Terminals**

Connector System: **Wire-to-Wire**

Number of Positions: **50**

Centerline (Pitch): **2.5 mm [.098 in]**

[All Receptacle and Tab Housing: 2.5 mm Pitch, 250V \(54\)](#)

Features

Product Type Features

Connector Product Type	Housing
Connector & Housing Type	Housing for Male Terminals
Connector System	Wire-to-Wire
Sealable	No
Connector & Contact Terminates To	Wire & Cable

Configuration Features

Number of Positions	50
Number of Rows	2

Body Features

Primary Product Color	Black
-----------------------	-------

Termination Features

Termination Method to Wire & Cable	Crimp
------------------------------------	-------

Mechanical Attachment

Mating Retention	With
Connector Mounting Type	Panel Mount



Housing Features

Centerline (Pitch)	2.5 mm[.098 in]
--------------------	-----------------

Dimensions

Row-to-Row Spacing	3.75 mm[.147 in]
--------------------	------------------

Usage Conditions

Operating Temperature Range	-55 – 105 °C[-67 – 221 °F]
-----------------------------	----------------------------

Operation/Application

Circuit Application	Signal
---------------------	--------

Product Compliance

[For compliance documentation, visit the product page on TE.com>](#)

EU RoHS Directive 2011/65/EU	Compliant
EU ELV Directive 2000/53/EC	Compliant
China RoHS 2 Directive MIIT Order No 32, 2016	No Restricted Materials Above Threshold
EU REACH Regulation (EC) No. 1907/2006	Current ECHA Candidate List: JUNE 2023 (235) Candidate List Declared Against: JAN 2021 (211) SVHC > Threshold: Pb (.35% in Component) Article Safe Usage Statements: Do not eat, drink or smoke when using this product. Wash thoroughly after handling. Recycle if possible and dispose of the article by following all applicable governmental regulations relevant to your geographic location.
Halogen Content	Not Low Halogen - contains Br or Cl > 900 ppm.
Solder Process Capability	Not applicable for solder process capability

Product Compliance Disclaimer

This information is provided based on reasonable inquiry of our suppliers and represents our current actual knowledge based on the information they provided. This information is subject to change. The part numbers that TE has identified as EU RoHS compliant have a maximum concentration of 0.1% by weight in homogenous materials for lead, hexavalent chromium, mercury, PBB, PBDE, DBP, BBP, DEHP, DIBP, and 0.01% for cadmium, or qualify for an exemption to these limits as defined in the Annexes of Directive 2011/65/EU (RoHS2). Finished electrical and electronic equipment products will be CE marked as required by Directive 2011/65/EU. Components may not be CE marked. Additionally, the part numbers that TE has identified as EU ELV compliant have a maximum concentration of 0.1% by weight in homogenous materials for lead, hexavalent chromium, and mercury, and 0.01% for cadmium, or qualify for an exemption to these limits as defined in the Annexes of Directive 2000/53/EC (ELV). Regarding the REACH Regulation, the information TE provides on SVHC in articles for this part number is based on the latest European Chemicals Agency (ECHA) 'Guidance on requirements for substances in articles' posted at this URL: <https://echa.europa.eu/guidance-documents/guidance-on-reach>

Compatible Parts



Also in the Series | Dynamic 2000 Series

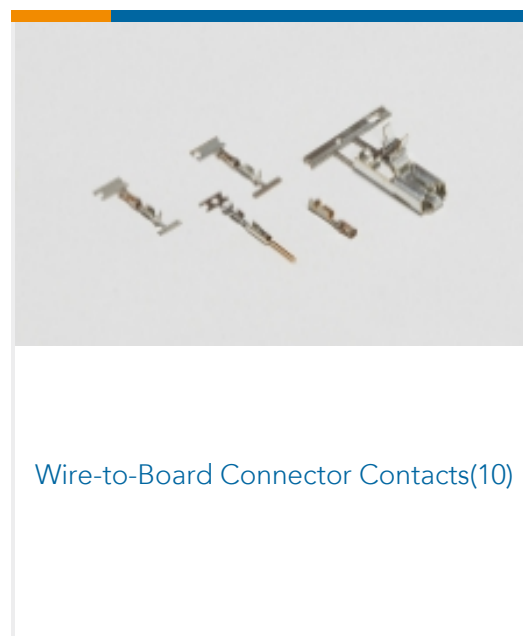
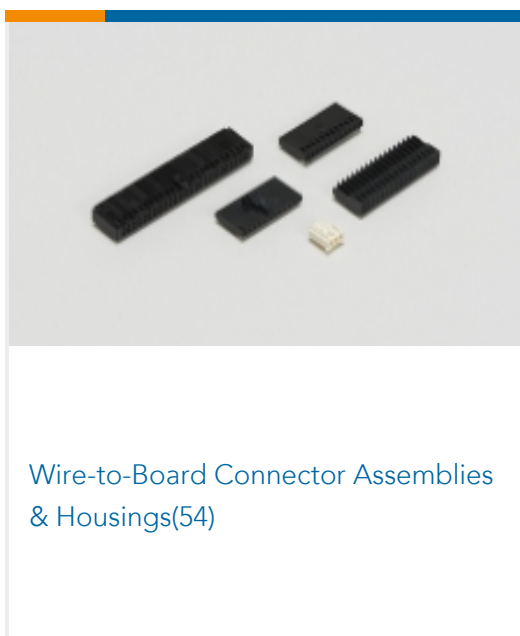
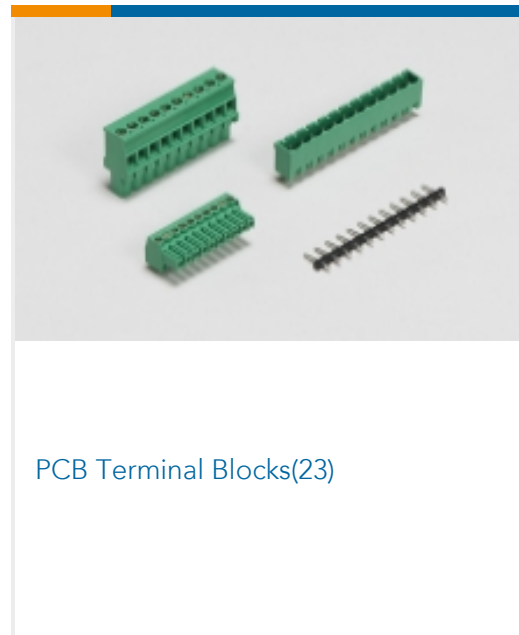
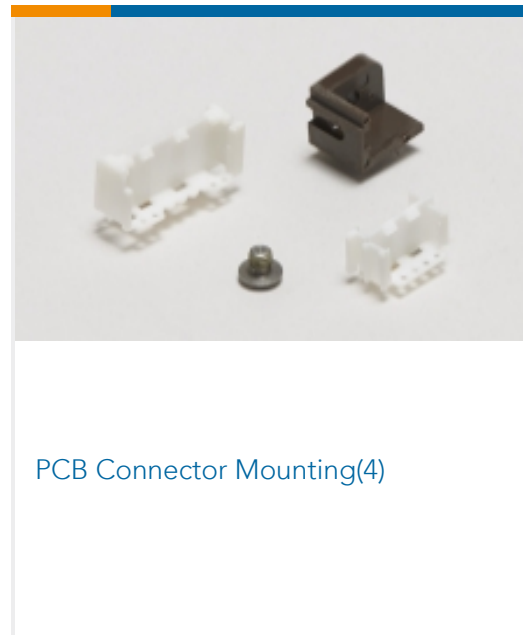
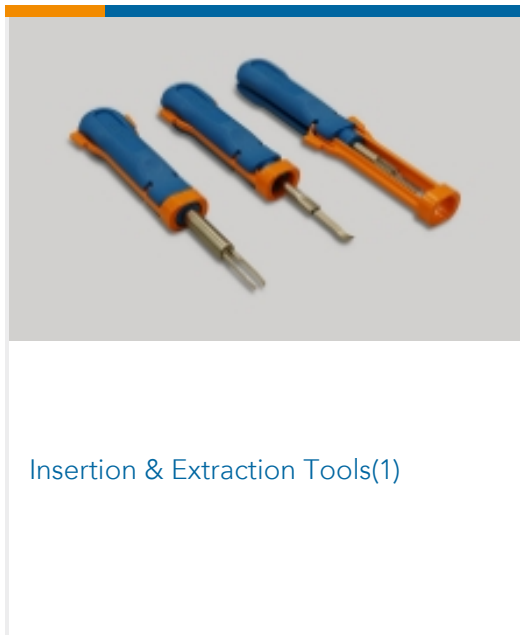

Customers Also Bought

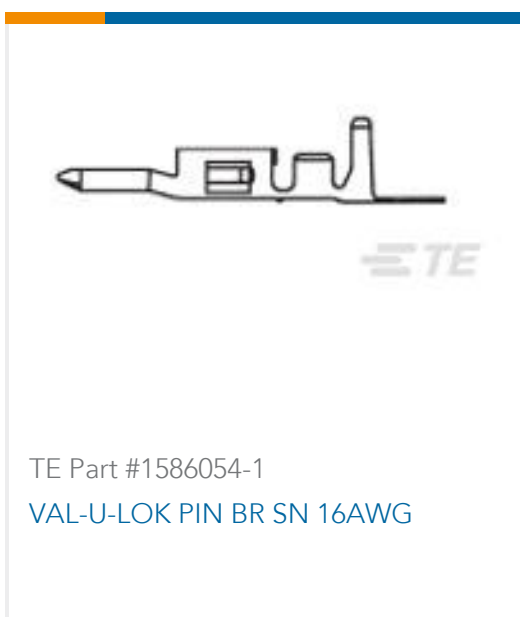
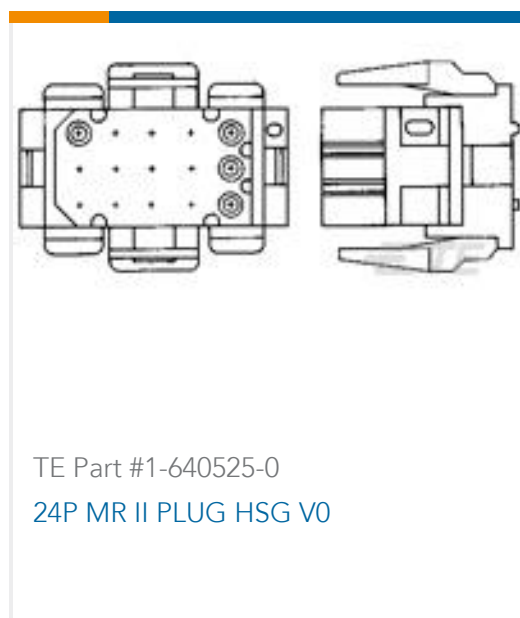



Documents

Product Drawings

[DYNAMIC D-2000 TAB ASSY 50P](#)

English

CAD Files

[3D PDF](#)

3D

Customer View Model

[ENG_CVM_CVM_1376073-2_A.2d_dxf.zip](#)

English

Customer View Model

[ENG_CVM_CVM_1376073-2_A.3d_igs.zip](#)

English

Customer View Model

[ENG_CVM_CVM_1376073-2_A.3d_stp.zip](#)

English

By downloading the CAD file I accept and agree to the [Terms and Conditions](#) of use.

Datasheets & Catalog Pages

[1-1773721-5_DYNAMIC_SERIES_ORG](#)

English

[1-1773732-4_DYNAMIC_SERIES_CATALOG_ENGLISH](#)

Japanese

[1-1773732-4_DYNAMIC_SERIES_CATALOG_ENGLISH](#)

English

Product Specifications

[Dynamic Connector D-2000 Series](#)

Japanese

[Application Specification](#)

Japanese