

- NOTES:
- CABLE LENGTH DEPENDS ON WIRE GAUGE, DATA RATE, AND HOST BOARD DRIVER CAPABILITIES
 - MATERIALS:
 - BACKSHELLS - ZINC DIE CAST WITH BRIGHT NICKEL PLATING
 - DELATCH - STAINLESS STEEL WITH OVERMOLDED NYLON
 - PCB - HALOGEN FREE
 - RAW CABLE JACKET- PVC
 - RIVETS - STAINLESS STEEL
 - IMPEDANCE - 100 OHMS DIFFERENTIAL
 - 'P1' LABEL REQUIRED ON zQ END, 'P2' & 'P3' LABELS REQUIRED ON BOTH 2zQ ENDS
 - RoHS COMPLIANT, NO EXEMPTIONS
 - ALL PART NUMBERS MAY USE TEMPFLEX OR BELDEN CABLE

THIS DRAWING CONTAINS INFORMATION THAT IS PROPRIETARY TO MOLEX ELECTRONIC TECHNOLOGIES, LLC AND SHOULD NOT BE USED WITHOUT WRITTEN PERMISSION									
DIMENSION UNITS	SCALE	CURRENT REV DESC: REMOVED OBSOLETE PART NUMBER AS PER PCN#512658.							
mm	2:1	molex ZQSFP+ TO 2X ZQSFP+ BREAKOUT CABLE ASSEMBLY PRODUCT CUSTOMER DRAWING							
GENERAL TOLERANCES (UNLESS SPECIFIED)									
ANGULAR TOL	± 1.0°								
4 PLACES	±								
3 PLACES	±								
2 PLACES	± 0.13	EC NO: 722794	2022/10/07		DRWN: SANTHN		2022/10/12		
1 PLACE	± 0.25	CHK'D: GGA	2022/10/12		APPR: GGA		2022/10/12		
0 PLACES	±	INITIAL REVISION:		2017/01/11		DRWN: MTAMBRALLI		2017/02/07	
DRAFT WHERE APPLICABLE MUST REMAIN WITHIN DIMENSIONS		THIRD ANGLE PROJECTION		DRAWING	SERIES	MATERIAL NUMBER	CUSTOMER	SHEET NUMBER	
		DUST COVER		D-SIZE	100346	SEE PN TABLE	GENERAL MARKET	1 OF 3	

DOCUMENT STATUS	P1	RELEASE DATE	2022/10/12	10:21:53
-----------------	----	--------------	------------	----------

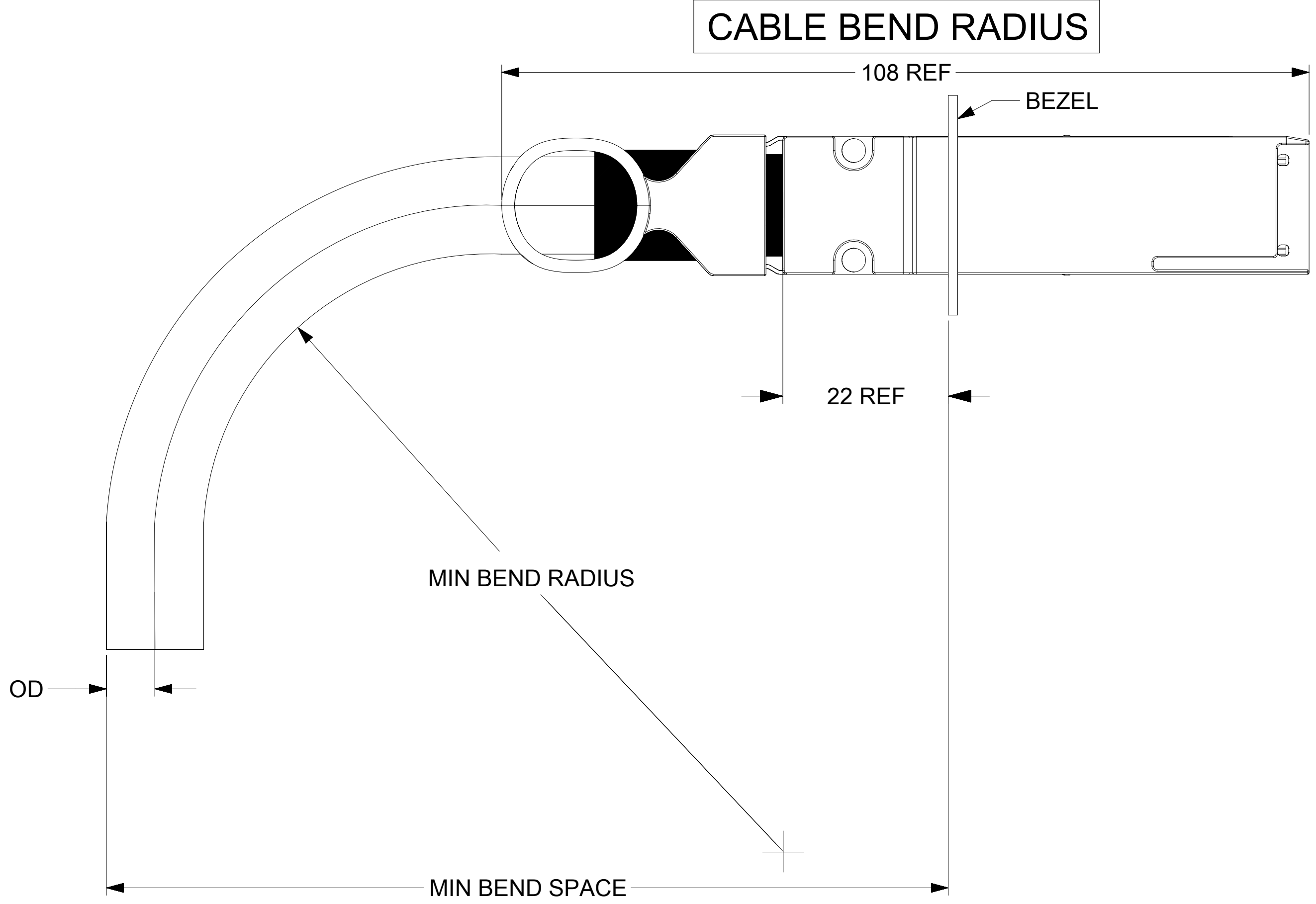

CABLE AWG	OD (mm)	MINIMUM BEND RADIUS (mm)	MINIMUM BEND SPACE (mm)
30	5.89	28	61
28	6.1	30	64
26	7.62	38	75

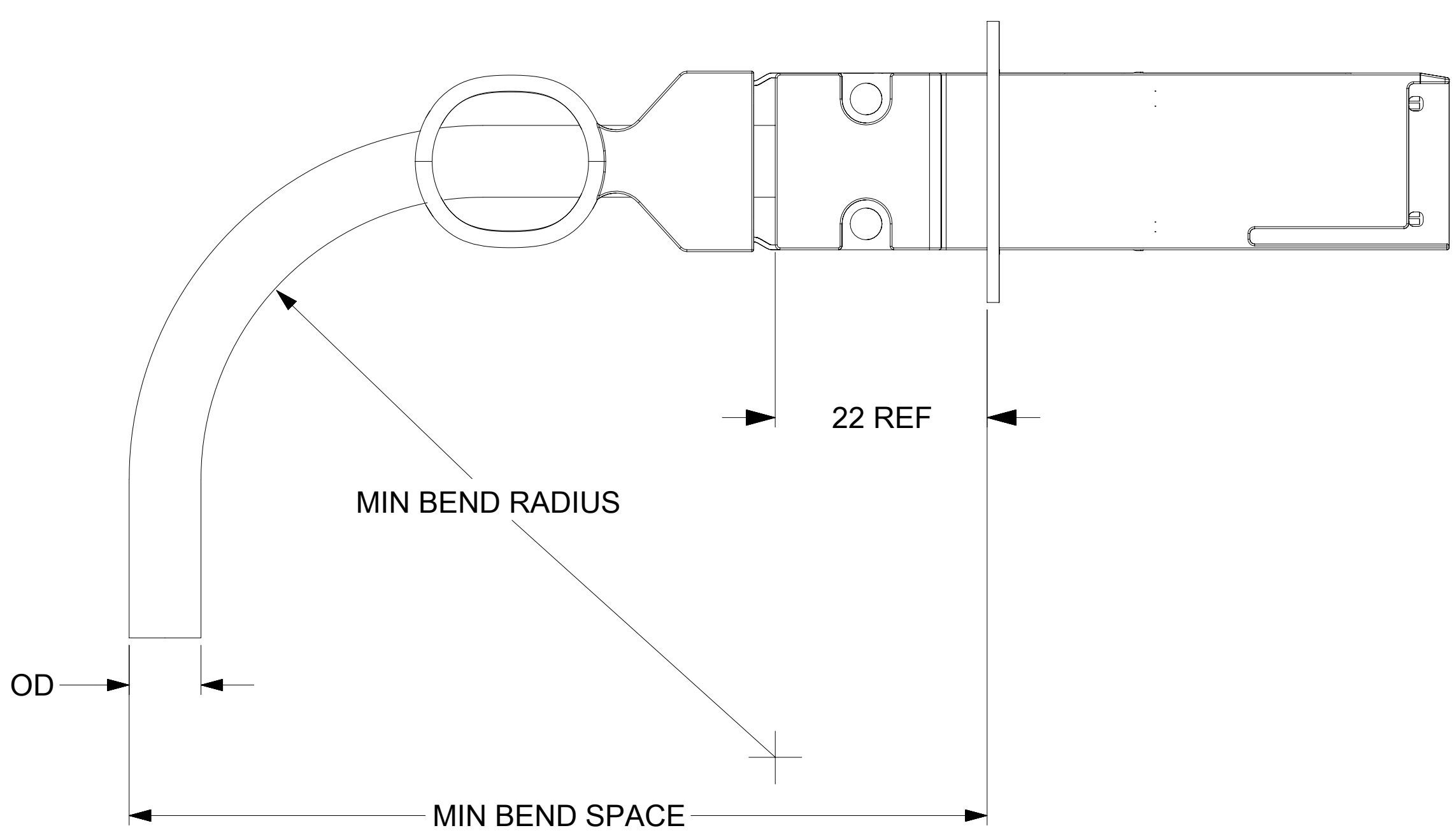

CABLE AWG	OD (mm)	MINIMUM BEND RADIUS (mm)	MINIMUM BEND SPACE (mm)
30	5.89	28	55
28	6.1	30	58
26	7.62	38	67

PINOUT

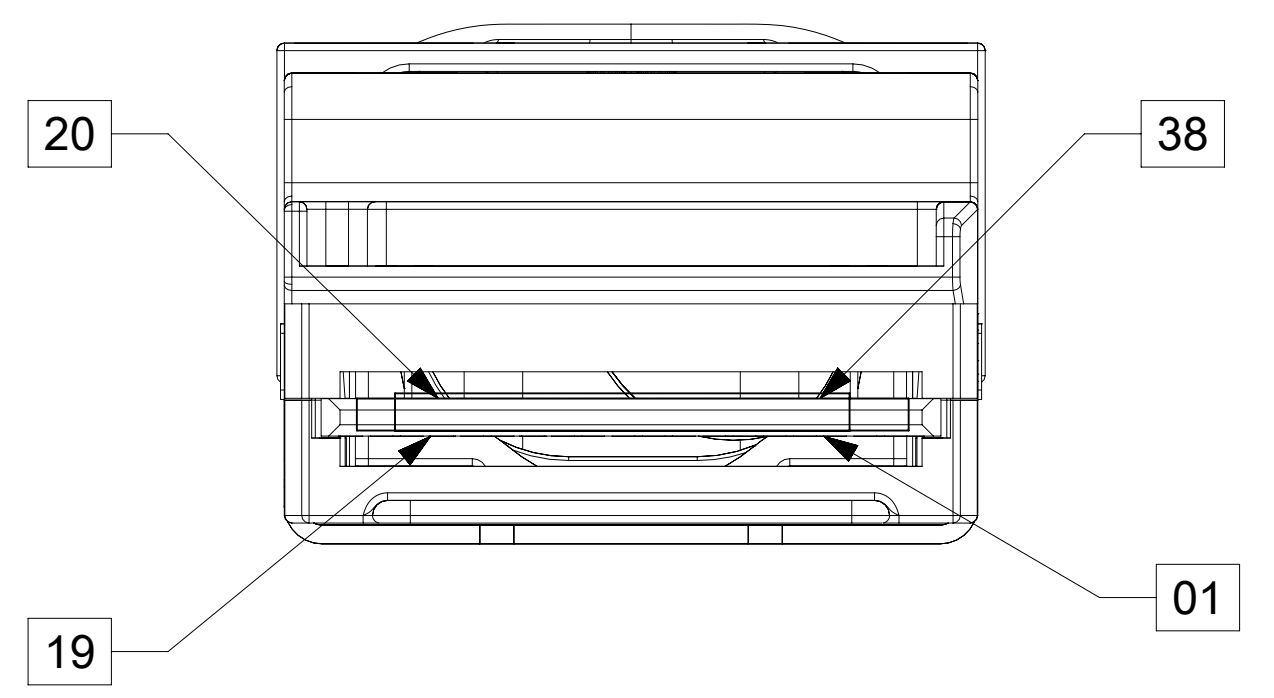

**LOW SPEED SIGNALS
P1, P2 & P3**

PAD	SIGNAL
08	ModSelL
09	ResetL
10	VccRx
11	SCL
12	SDA
27	ModPrsL
28	IntL
29	VccTx
30	Vcc1
31	LPMODE

WIRING DIAGRAM

QSFP P1		QSFP		PLUG
PAD	SIGNAL	SIGNAL	PAD	
38	GND	GND	19	P2
37	TX1-	Rx1-	18	
36	TX1+	Rx1+	17	
35	GND	GND	16	
19	GND	GND	38	
17	RX1+	Tx1+	36	
18	RX1-	Tx1-	37	
16	GND	GND	35	
01	GND	GND	20	
02	TX2-	Rx2-	21	
03	TX2+	Rx2+	22	
04	GND	GND	23	
20	GND	GND	01	
22	RX2+	Tx2+	03	
21	RX2-	Tx2-	02	
23	GND	GND	04	
35	GND	GND	19	P3
34	TX3-	Rx1-	18	
33	TX3+	Rx1+	17	
32	GND	GND	16	
16	GND	GND	38	
13	GND	GND	35	
14	RX3+	Tx1+	36	
15	RX3-	Tx1-	37	
04	GND	GND	20	
05	TX4-	Rx2-	21	
06	TX4+	Rx2+	22	
07	GND	GND	23	
23	GND	GND	01	
26	GND	GND	04	
25	RX4+	Tx2+	03	
24	RX4-	Tx2-	02	

QSFP+ PADS 1, 4, 7, 13, 16, 19, 20, 23, 26
32, 35 AND 38 ARE GND

THIS DRAWING CONTAINS INFORMATION THAT IS PROPRIETARY TO MOLEX ELECTRONIC TECHNOLOGIES, LLC AND SHOULD NOT BE USED WITHOUT WRITTEN PERMISSION

DIMENSION UNITS mm	SCALE 2:1	CURRENT REV DESC: REMOVED OBSOLETE PART NUMBER AS PER PCN#512658.			
GENERAL TOLERANCES (UNLESS SPECIFIED)					
ANGULAR TOL	± 1.0°	EC NO: 722794	DOCUMENT NUMBER		
4 PLACES	±	DRWN: SANTHN 2022/10/07	1003461051		
3 PLACES	±	CHK'D: GGA 2022/10/12	DOC TYPE	DOC PART	REVISION
2 PLACES	± 0.13	APPR: GGA 2022/10/12	PSD	001	M1
1 PLACE	± 0.25	INITIAL REVISION: DRWN: MTAMBRALLI 2017/01/11 APPR: ARAYBURN 2017/02/07	SHEET NUMBER		
0 PLACES	±		2 OF 3		
DRAFT WHERE APPLICABLE MUST REMAIN WITHIN DIMENSIONS		THIRD ANGLE PROJECTION	DRAWING	SERIES	SHEET NUMBER
			D-SIZE	100346	
			SEE PN TABLE	GENERAL MARKET	

LABEL DETAILS

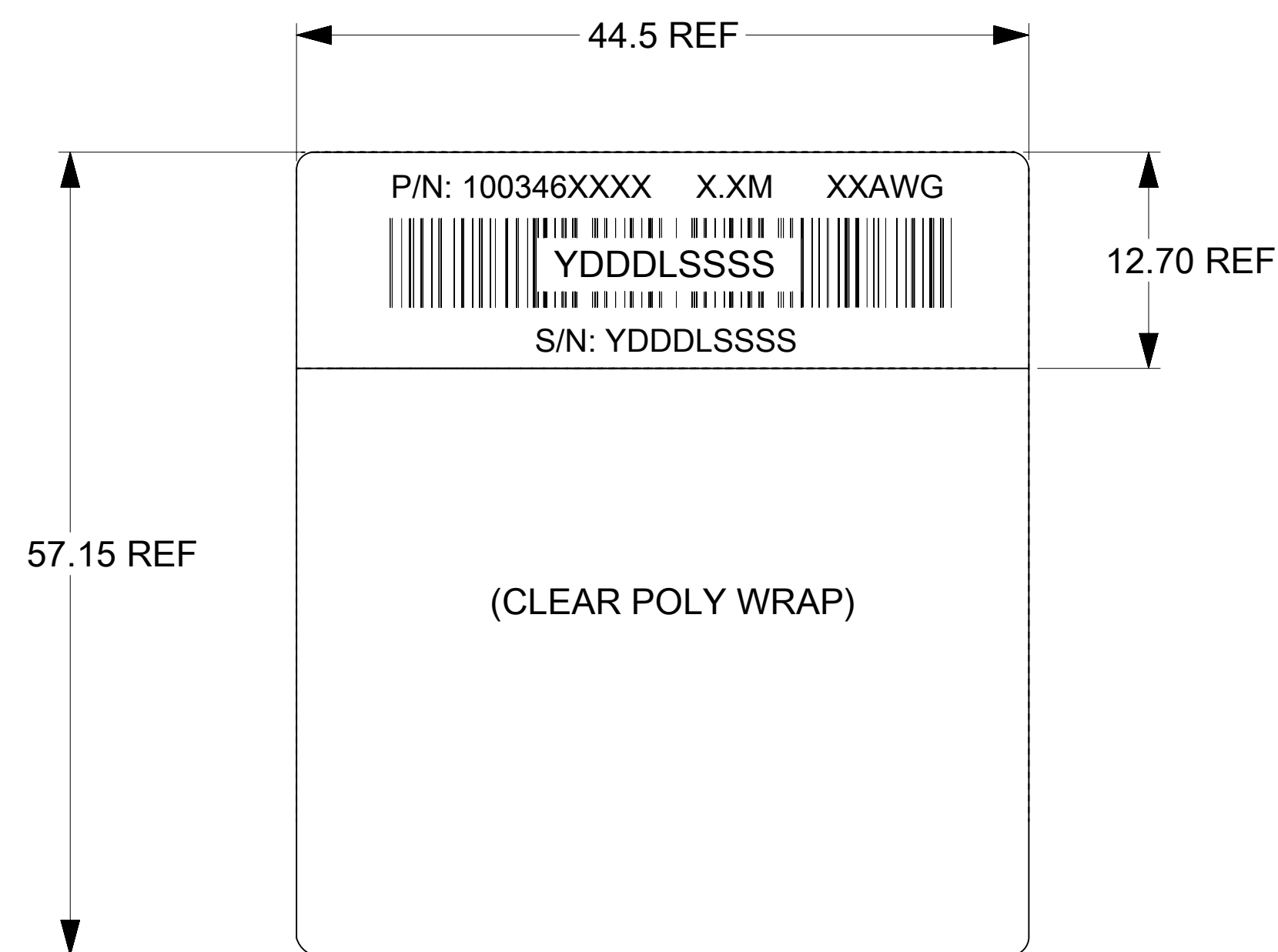

P/N: 100346XXXX - MOLEX PART NUMBER (SEE P/N TABLE)
 X.XM - CABLE LENGTH IN METERS (EXAMPLES - 0.5M, 1.0M)
 S/N: YDDLSSSS - SERIAL NUMBER
 Y - YEAR, THE LAST DIGIT OF YEAR
 DDD - DAY OF THE YEAR
 L - LOCATION
 1 - USA
 2 - MEXICO
 3 - CHINA
 4 - PHILIPPINES
 SSSS - SERIAL NUMBER (0001-9999)

END LABEL

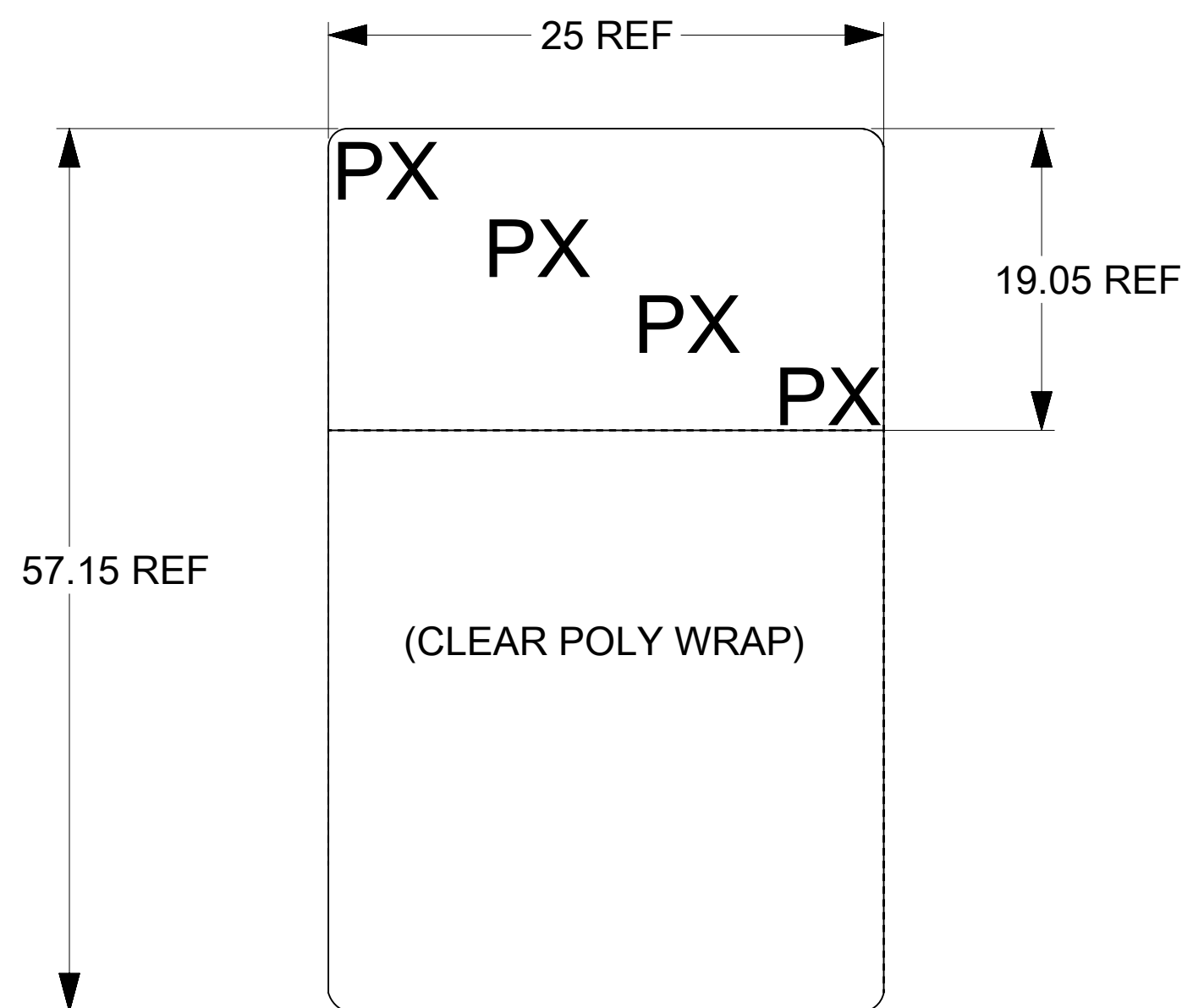

'P2' & 'P3' LABELS REQUIRED ON BOTH 2zQ ENDS.
 'P1' LABEL REQUIRED ON zQ END.
 PX - P1/P2/P3 ENDS

MOLEX P/N	LENGTH(M)	TOL.(M)	AWG	RAW CABLE
1003461051	0.5	±0.05	30	TEMPFLEX
1003461071	0.75	±0.05	30	
1003461101	1.0	±0.05	30	
1003461151	1.5	±0.08	30	
1003461201	2.0	±0.08	30	
1003461251	2.5	±0.08	30	
1003461301	3.0	±0.08	30	
1003462051	0.5	±0.05	28	
1003462071	0.75	±0.05	28	
1003462101	1.0	±0.05	28	
1003462151	1.5	±0.05	28	
1003462201	2.0	±0.08	28	
1003462251	2.5	±0.08	28	
1003462301	3.0	±0.08	28	
1003463051	0.5	±0.05	26	
1003463071	0.75	±0.05	26	
1003463101	1.0	±0.05	26	
1003463151	1.5	±0.05	26	
1003463201	2.0	±0.08	26	
1003463251	2.5	±0.08	26	
1003463301	3.0	±0.08	26	
1003463351	3.5	±0.08	26	
1003463401	4.0	±0.08	26	
1003463451	4.5	±0.08	26	
1003463501	5.0	±0.08	26	

*CABLES SHORTER THAN 1.0M, MAY NOT MEET ALL SI PARAMETERS OF IEEE 802.3BJ.

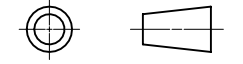
THIS DRAWING CONTAINS INFORMATION THAT IS PROPRIETARY TO MOLEX ELECTRONIC TECHNOLOGIES, LLC AND SHOULD NOT BE USED WITHOUT WRITTEN PERMISSION										
DIMENSION UNITS	SCALE	CURRENT REV DESC: REMOVED OBSOLETE PART NUMBER AS PER PCN#512658.								
mm	1:1	 ZQSFP+ TO 2X ZQSFP+ BREAKOUT CABLE ASSEMBLY PRODUCT CUSTOMER DRAWING								
GENERAL TOLERANCES (UNLESS SPECIFIED)										
ANGULAR TOL	± 1.0°									
4 PLACES	±									
3 PLACES	±									
2 PLACES	± 0.13									
1 PLACE	± 0.25	EC NO: 722794	2022/10/07		DOCUMENT NUMBER			DOC TYPE	DOC PART	REVISION
0 PLACES	±	DRWN: SANTHN	2022/10/12		1003461051			PSD	001	M1
DRAFT WHERE APPLICABLE MUST REMAIN WITHIN DIMENSIONS		APPR: GGA	2022/10/12		INITIAL REVISION:					
		DRWN: MTAMBRALLI	2017/01/11		SERIES					
		APPR: ARAYBURN	2017/02/07		MATERIAL NUMBER			CUSTOMER		
		THIRD ANGLE PROJECTION		DRAWING	SHEET	SEE PN TABLE		GENERAL MARKET		SHEET NUMBER
				D-SIZE	100346					3 OF 3