

General Description

The Micrel MIC61300 is a 3A output, low input voltage, single-supply regulator. This regulator operates over a single input voltage range of 1.1V to 3.6V and offers an ultra-low dropout less than 350mV over the entire operating temperature range.

The MIC61300 is designed to drive digital circuits requiring low voltages at high currents such as DSPs, FPGAs, microcontrollers, etc. The regulator is available as a 1.0V fixed-output voltage option or as an adjustable-output voltage option.

The MIC61300 is stable with a 47 μ F, low-ESR ceramic output capacitor, and includes protection features such as thermal shutdown, current limiting and logic enable.

The MIC61300 is offered in two different packages: a low-profile, leadless 10-pin 3mm x 3mm MLF[®] and a 10-pin ePad MSOP. The MIC61300 has an operating junction temperature range of -40°C to +125°C.

Data sheets and support documentation can be found on Micrel's web site at: www.micrel.com.

Features

- Single V_{IN} rail: 1.1V to 3.6V
- Output voltage accuracy: $\pm 2.5\%$ over temperature
- Typical dropout of 150mV at room temperature
 - Maximum dropout of 350mV at full load over temperature
- Output voltage adjustable down to 0.5V
- Soft-start control via external capacitor
- Excellent line and load regulation
- Logic controlled shutdown
- Thermal-shutdown and current-limit protection
- 10-pin 3mm x 3mm MLF[®] package
- 10-pin ePad MSOP package
- Junction temperature range from -40°C to +125°C

Applications

- Point-of-load applications
- ASIC / Microprocessor power supply
- FPGA power supply
- Telecom / Networking cards
- Wireless infrastructure

Typical Application

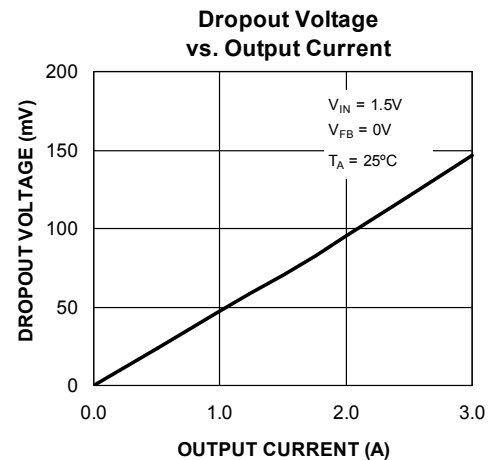
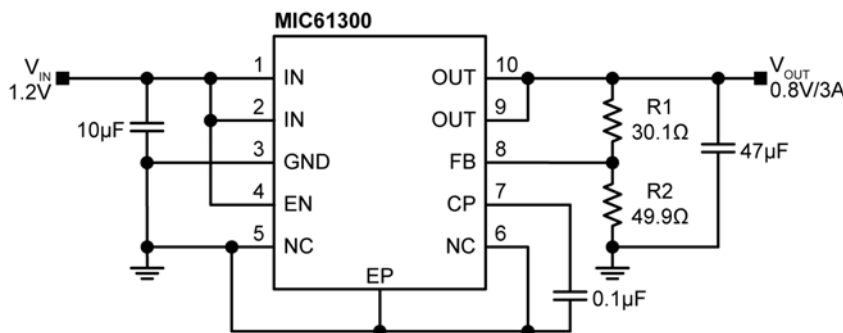

Ordering Information

Part Number	Top Mark	Voltage	Temperature Range	Package	Lead Finish
MIC61300YMME	61300	Adjustable	-40°C to +125°C	ePad MSOP-10L	Pb Free
MIC61300-10YMME	Z10J	1.0V	-40°C to +125°C	ePad MSOP-10L	Pb Free
MIC61300YML	ZJ30	Adjustable	-40°C to +125°C	3mmx3mm MLF [®] -10L	Pb Free
MIC61300-10YML	10ZJ	1.0V	-40°C to +125°C	3mmx3mm MLF [®] -10L	Pb Free

Pin Configuration

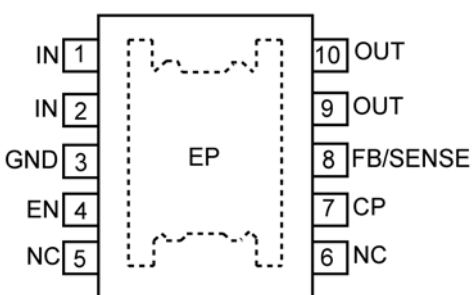

10-Pin ePad MSOP (MME)

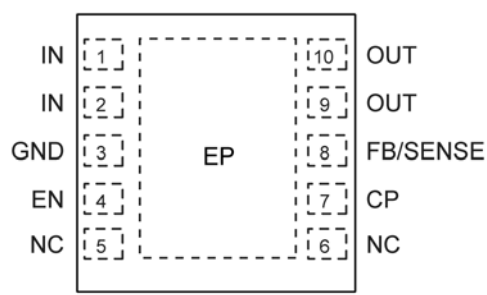

10-Pin 3mm x 3mm MLF[®] (ML)

Pin Description

Pin Number	Pin Name	Pin Function
1, 2	IN	Input Voltage.
3	GND	Ground: Input and output return pin.
4	EN	Enable: Active-high control input that allows turn-on/-off of the LDO.
5, 6	NC	No external function. Tie to ground.
7	CP	Internal Charge Pump Circuit Output: Connect a 0.1 μ F to 1 μ F capacitor from CP pin-to-GND to control the ramp rate of the output.
8	FB	Adjustable Regulator Feedback Input: Connect to the resistor voltage divider network that is placed from OUT pin to GND pin in order to set the output voltage.
	SENSE	Fixed-Output Voltage Sense Input: Apply a Kelvin connection from this pin of the fixed output at the point-of-load to sense the output voltage level.
9, 10	OUT	Regulator Output: The output voltage is set by the resistor divider connected from V _{OUT} to GND (with the divided connection tied to FB). A 47 μ F ceramic capacitor with low ESR is required to maintain stability. See <i>Applications Information</i> .
EP	GND	Connect to GND.

Absolute Maximum Ratings^(1, 2)

V_{IN} to GND.....	-0.3V to 4.5V
V_{CP} to GND.....	-0.3V to 5.5V
V_{OUT} to GND.....	-0.3V to V_{IN}
V_{SENSE} to GND.....	-0.3V to V_{IN}
V_{EN} to GND.....	-0.3V to 4.5V
V_{FB} to GND.....	-0.3V to V_{IN}
Junction Temperature (T_J).....	150°C
Lead Temperature (soldering, 10 sec.).....	260°C
Storage Temperature (T_S).....	-65°C to +150°C

Operating Ratings⁽³⁾

Supply Voltage (V_{IN}).....	1.1V to 3.6V
Enable Voltage (V_{EN}).....	-0.3V to 3.6V
Output Voltage Range (V_{OUT}).....	0.5V to 3.0V
Ambient Temperature Range (T_A).....	-40°C to +85°C
Junction Temperature (T_J).....	-40°C to +125°C
Maximum Power Dissipation (P_D).....	Note 4
Package Thermal Resistance	
3mm × 3mm MLF-10L (θ_{JA}).....	60.7°C/W
ePad MSOP-10 (θ_{JA}).....	76.7°C/W

Electrical Characteristics⁽⁵⁾

$V_{IN} = V_{OUT} + 0.4V$; $V_{EN} = 1.1V$; $I_{OUT} = 10mA$; $C_{CP} = 0.1\mu F$; $C_{OUT} = 47\mu F$; $T_J = 25^\circ C$. **Bold** values indicate $-40^\circ C \leq T_J \leq +125^\circ C$, unless noted.

Parameter	Condition	Min.	Typ.	Max.	Units
Power Supply Input					
Input Voltage Range (V_{IN})		1.1		3.6	V
Ground Pin Current	$I_{OUT} = 3A$; $V_{IN} = 1.4V$		1.8		mA
	$I_{OUT} = 3A$; $V_{IN} = 3.6V$		7.6	15	
Ground Current in Shutdown	$V_{EN} = 0V$; $V_{IN} = 2V$; $V_{OUT} = 0V$		0.1	10	μA
Reference					
Feedback Pin Voltage (FB Pin)	Adjustable Output	0.495	0.500	0.505	V
		0.4875	0.500	0.5125	
Output Voltage Accuracy (SENSE Pin)	Fixed Output	-1	0	+1	%
		-2.5	0	+2.5	
Load Regulation	$I_{OUT} = 10mA$ to 3A	-0.35		0.35	%
Line Regulation ⁽⁶⁾	$V_{IN} = (V_{OUT} + 0.4V)$ to 3.6V	-0.2	0.12	0.2	%/V
FB Pin Current	$V_{FB} = 0.5V$		0.01	1	μA
Current Limit					
Current Limit	$V_{OUT} = 0V$	3.5	4.7		A
Dropout Voltage					
Dropout Voltage ($V_{IN} - V_{OUT}$)	$I_{OUT} = 3A$		150	350	mV

Notes:

- Exceeding the absolute maximum rating may damage the device.
- Devices are ESD sensitive. Handling precautions recommended. Human body model (HBM), 1.5k in series with 100pF.
- The device is not guaranteed to function outside its operating rating.
- $P_{D(MAX)} = (T_{J(MAX)} - T_A) / \theta_{JA}$, where θ_{JA} , depends upon the printed circuit layout. See "Applications Information."
- Specification for packaged product only.
- $\Delta V_{OUT} (\%) = (0.12) \times \Delta V_{IN}$

Electrical Characteristics⁽⁵⁾ (Continued)

$V_{IN} = V_{OUT} + 0.4V$; $V_{EN} = 1.1V$; $I_{OUT} = 10mA$; $C_{CP} = 0.1\mu F$; $C_{OUT} = 47\mu F$; $T_J = 25^\circ C$. **Bold** values indicate $-40^\circ C \leq T_J \leq +125^\circ C$, unless noted.

Parameter	Condition	Min.	Typ.	Max.	Units
Enable Input					
EN Logic Level High		1.1	0.6		V
EN Logic Level Low			0.5	0.2	V
EN Hysteresis			100		mV
EN Pin Current	$V_{EN} = 0.2V$ (Regulator Shutdown)		0.02		μA
	$V_{EN} = 3.6V$ (Regulator Enabled)		15		
Start-Up Time	$C_{CP} = 0.1\mu F$; $C_{OUT} = 10\mu F$ $V_{IN} = 1.2V$, $V_{OUT} = 0.5V$		250	750	μs
Minimum Load Current					
Minimum Load Current		10			mA
Thermal Protection					
Over-Temperature Shutdown	T_J Rising		160		$^\circ C$
Over-Temperature Shutdown Hysteresis			5		$^\circ C$

Typical Characteristics

Dropout Voltage vs. Input Voltage

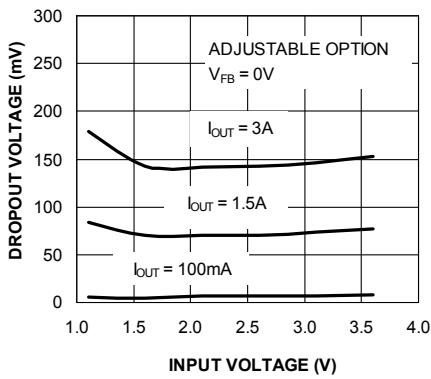

GND Pin Current vs. Input Voltage

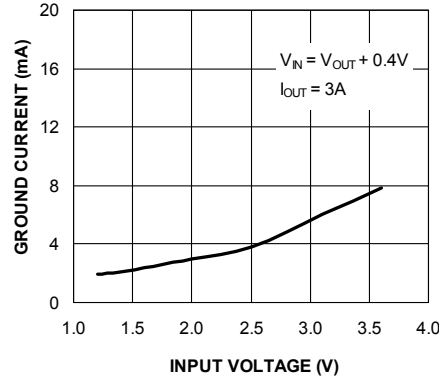

Shutdown Ground Current vs. Input Voltage

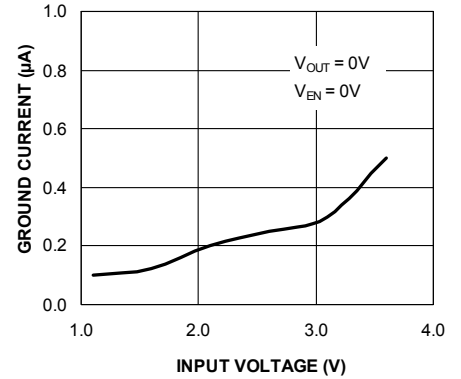

Feedback Voltage vs. Input Voltage

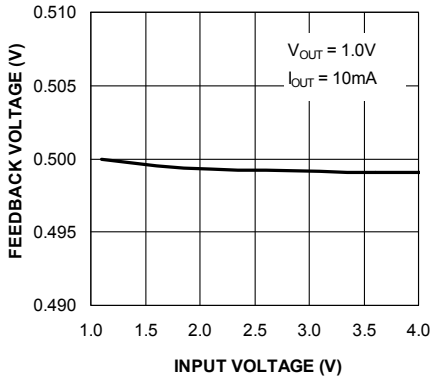

Feedback Pin Current vs. Input Voltage

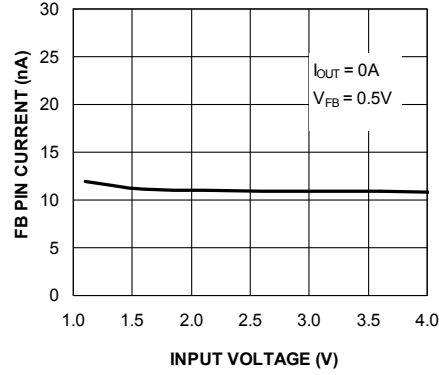

Load Regulation vs. Input Voltage

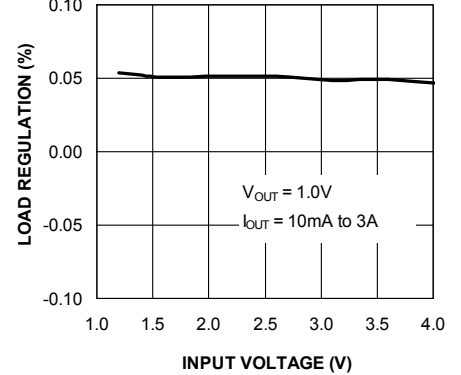

Short-Circuit Current vs. Input Voltage

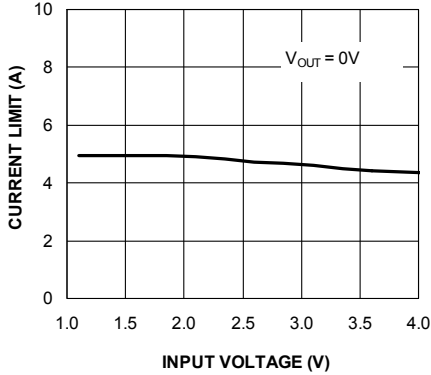

Enable Pin Current vs. Input Voltage

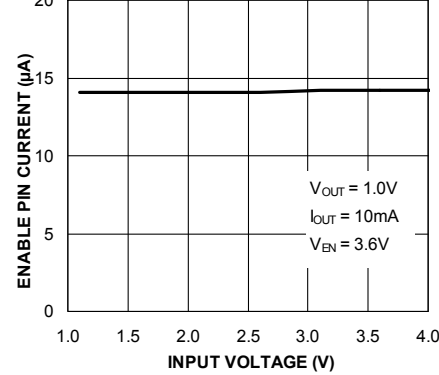

Charge Pump Voltage vs. Input Voltage

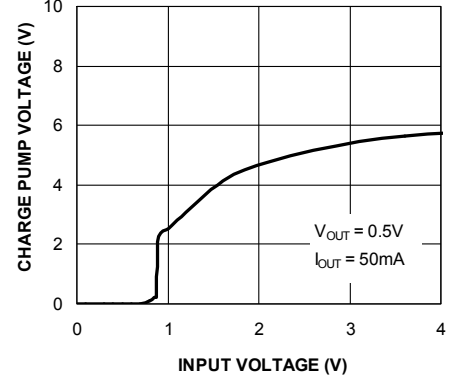

Typical Characteristics (Continued)

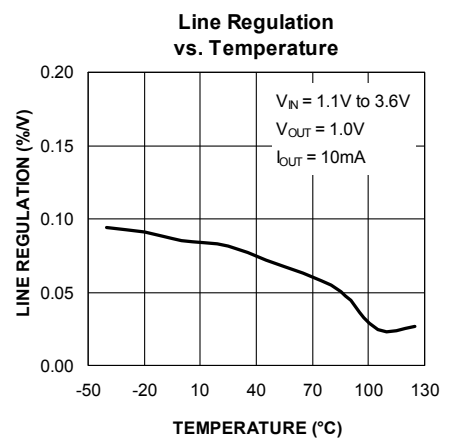
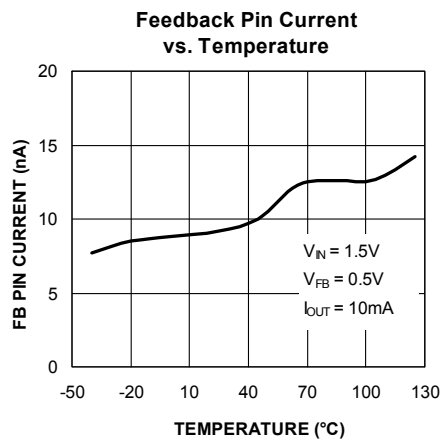
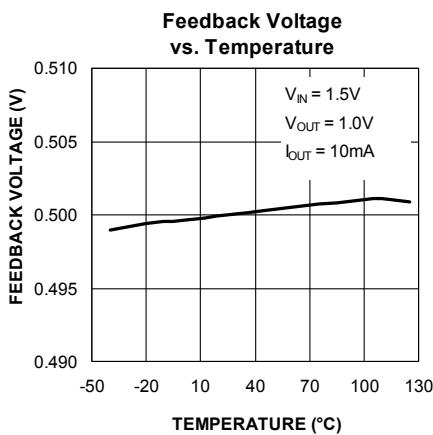
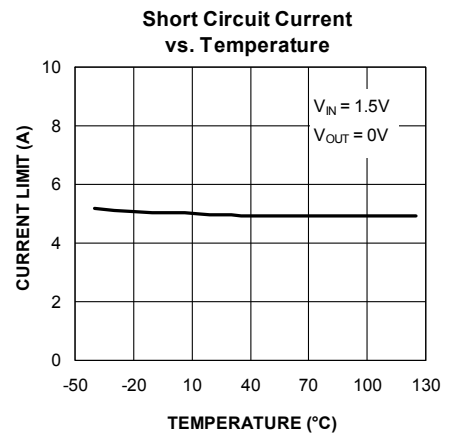
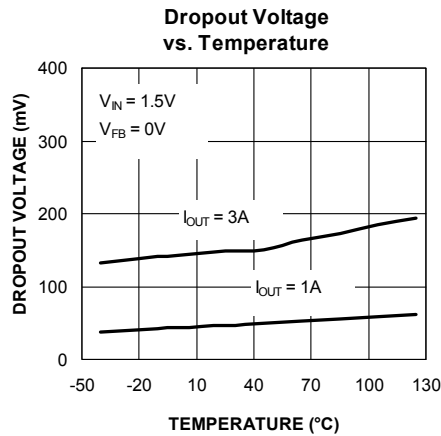
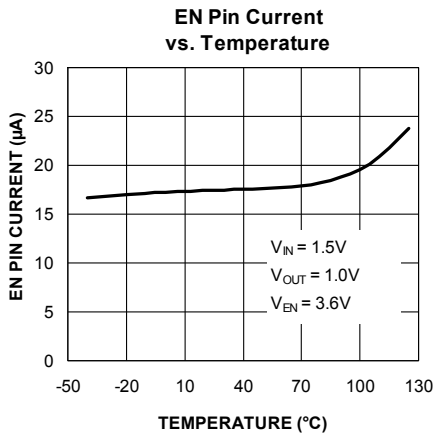
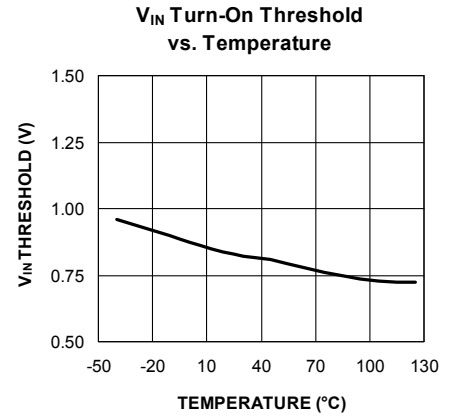
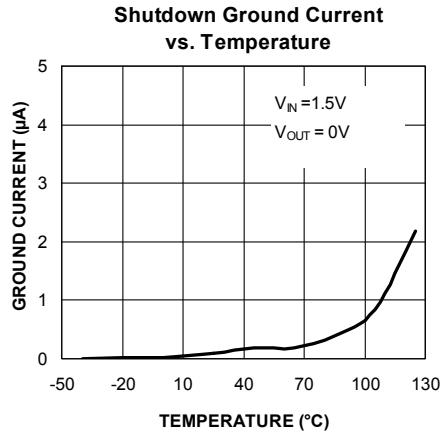
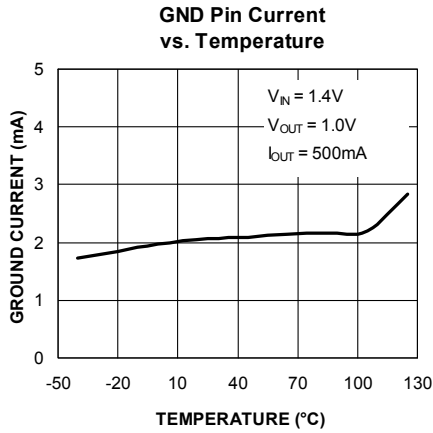

Typical Characteristics (Continued)

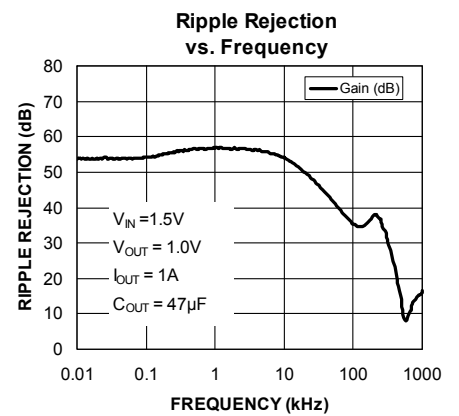
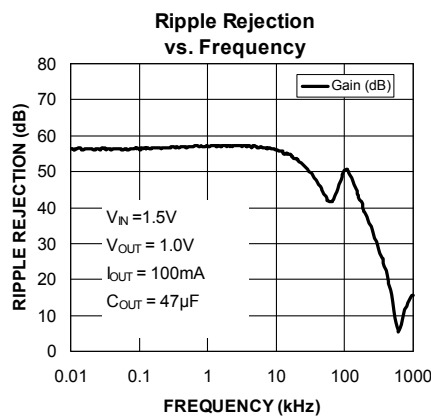
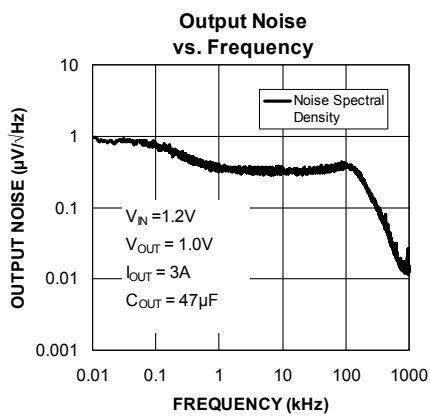
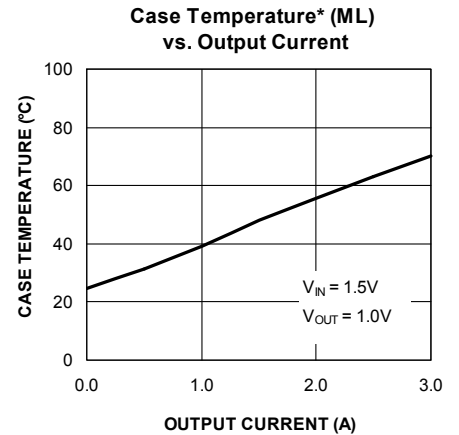
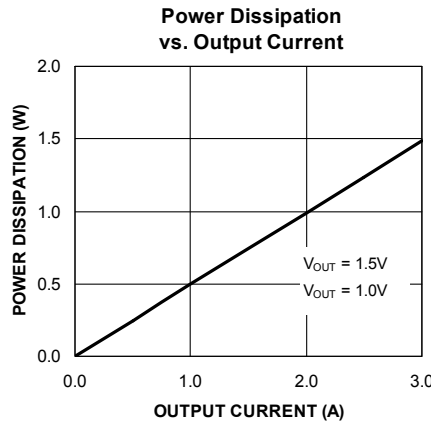
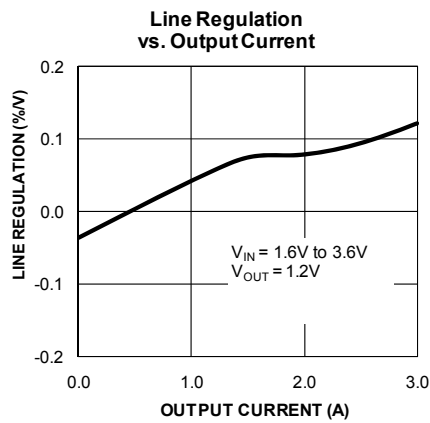
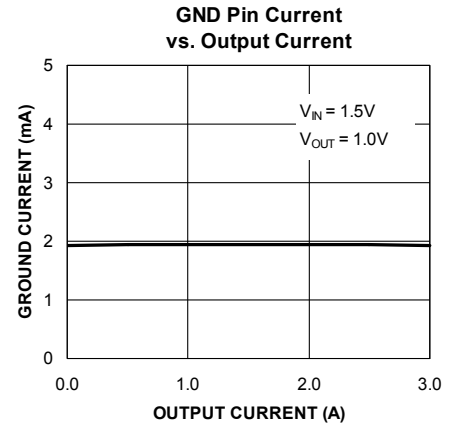
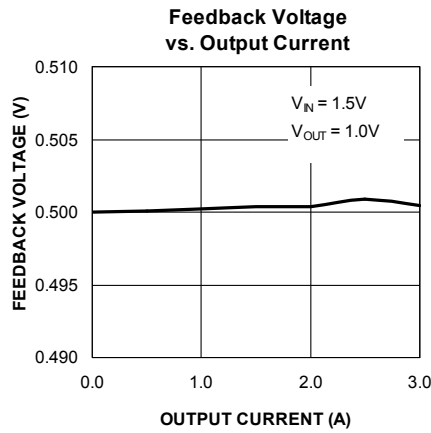
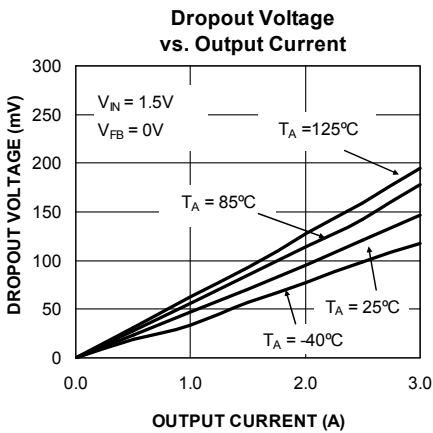

Case Temperature*: The temperature measurement was taken at the hottest point on the MIC61300 case mounted on a 2.25 square inch PCB at an ambient temperature of 25 $^\circ\text{C}$; see "Thermal Measurement" section. Actual results will depend upon the size of the PCB, ambient temperature and proximity to other heat emitting components.

Functional Characteristics

V_{IN} Turn-On, Soft-Start

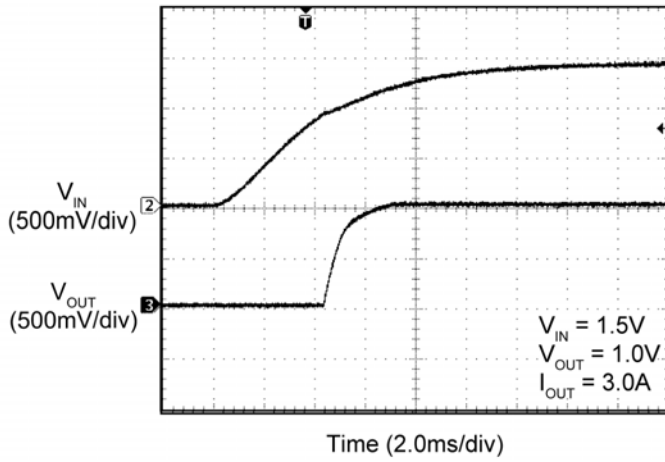

V_{IN} Soft Turn-Off

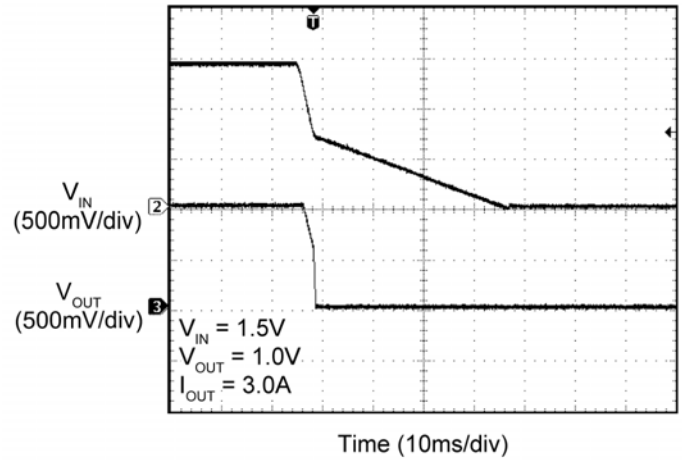

Enable Turn-On

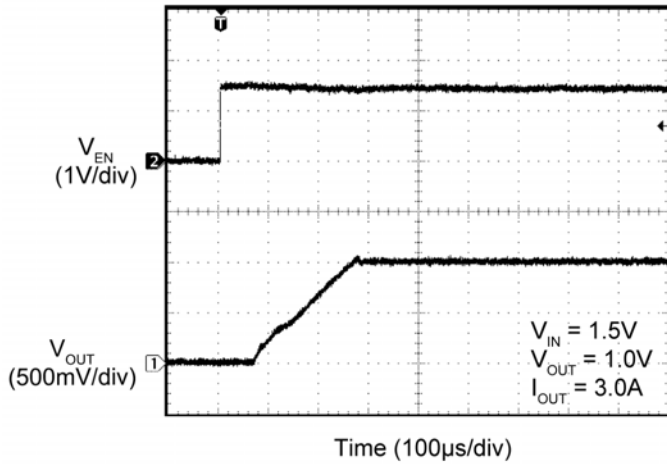

Enable Turn-Off

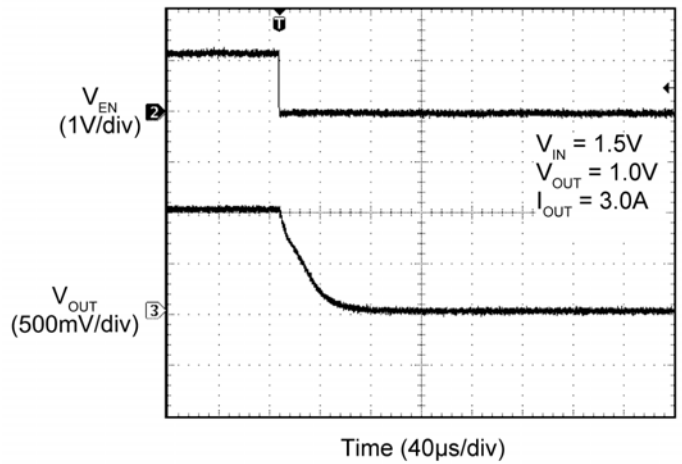

V_{IN} UVLO Threshold

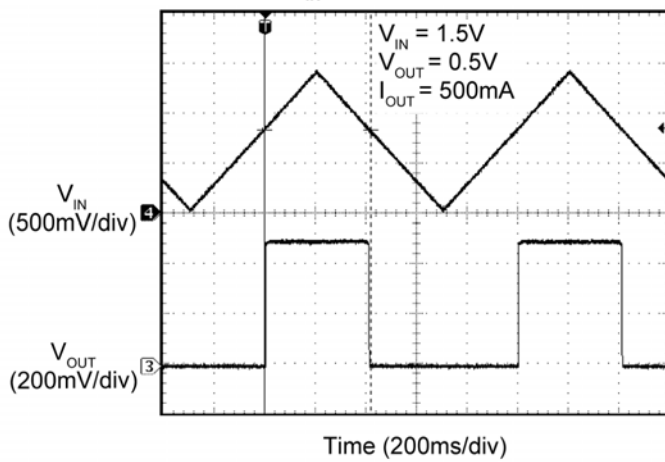

Enable Threshold

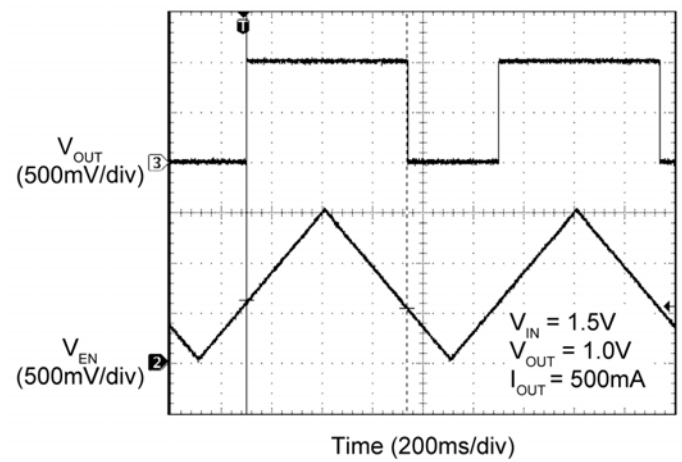

Functional Characteristics (Continued)

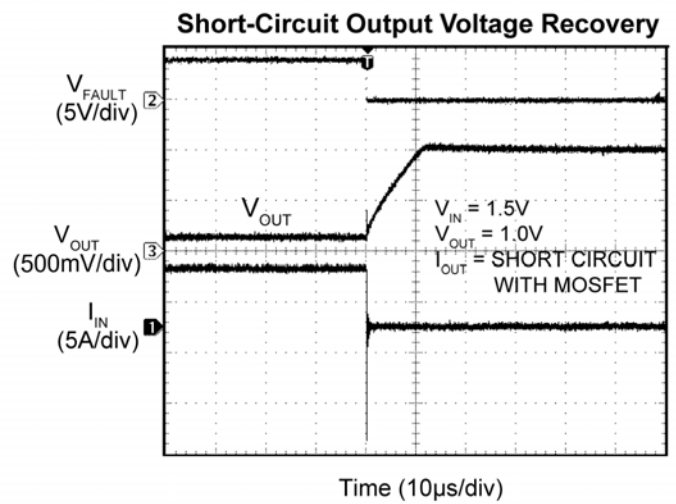
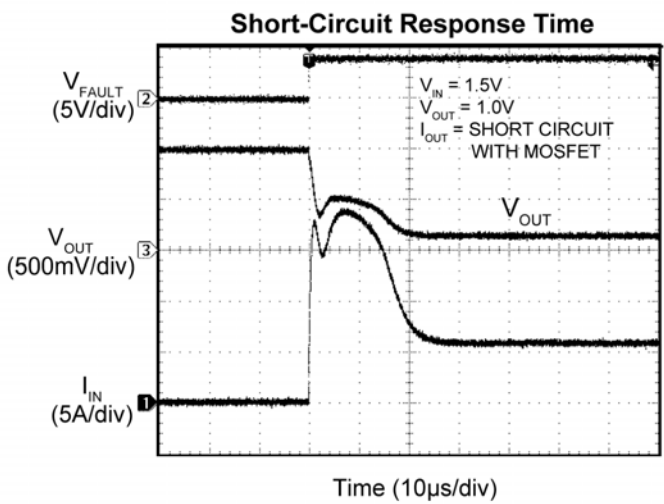
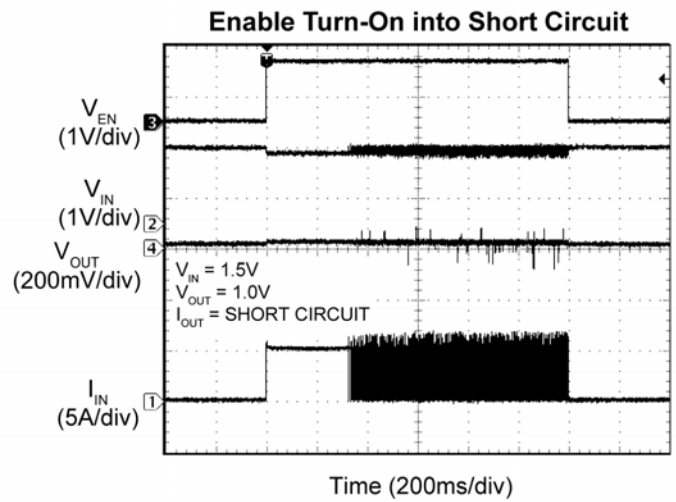
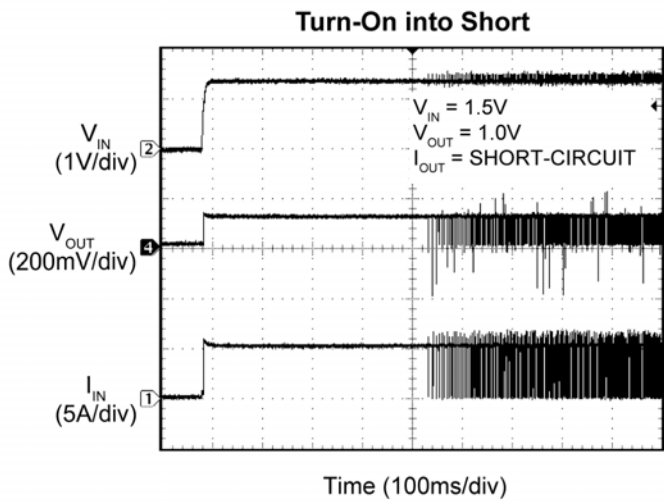
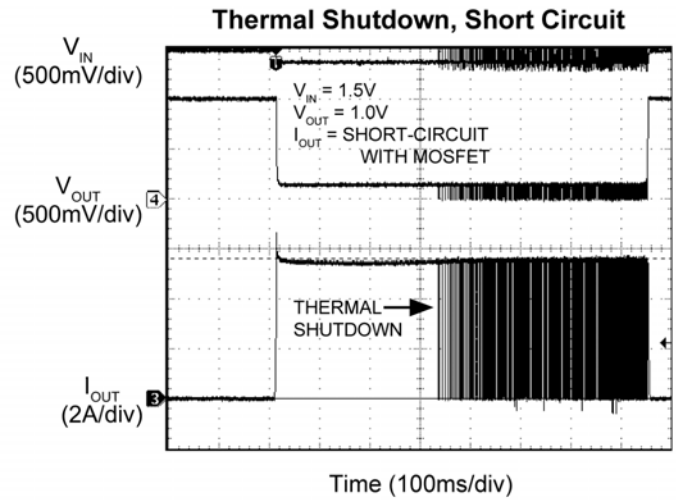
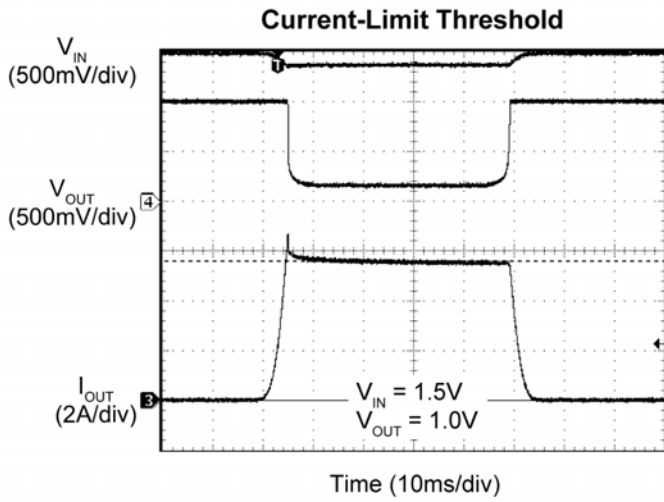

Functional Characteristics (Continued)

Inrush Current, $C_{OUT} = 47\mu F$

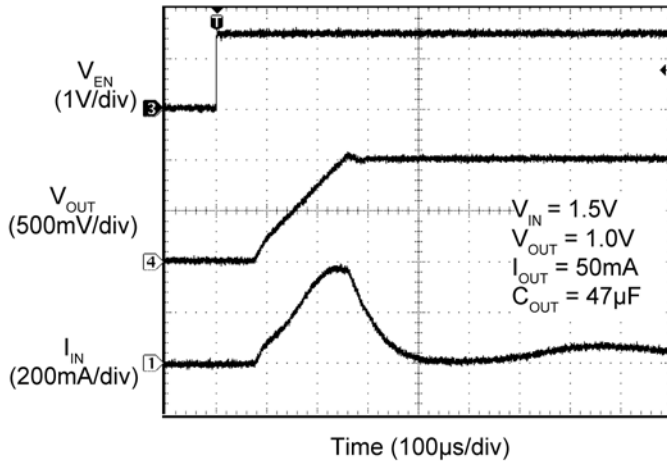

Inrush Current, $C_{OUT} = 100\mu F$

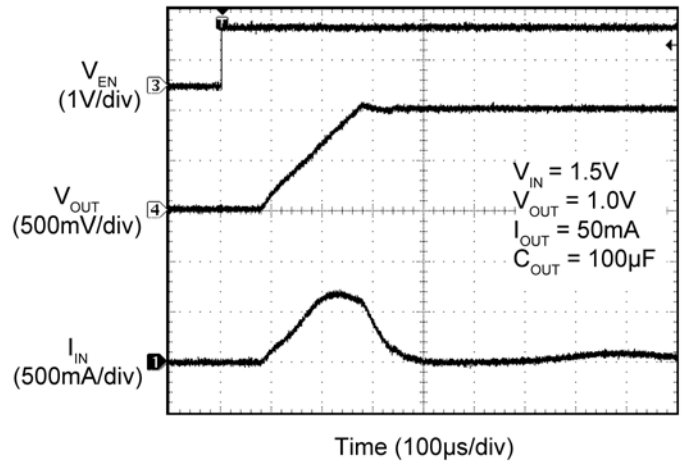

**Transient Response
 $V_{OUT} = 1.2V$ with $47\mu F$**

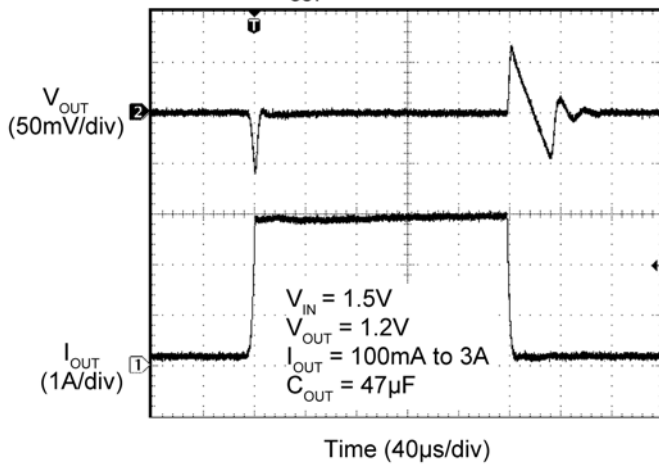

**Transient Response
 $V_{OUT} = 0.5V$ with $47\mu F$ (x2)**

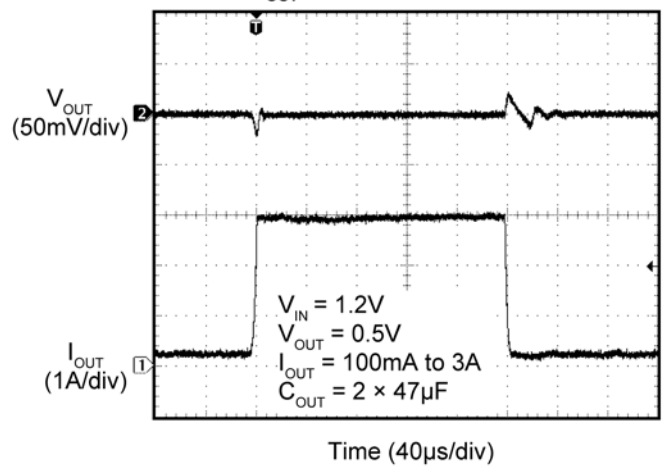

Line Transient Response

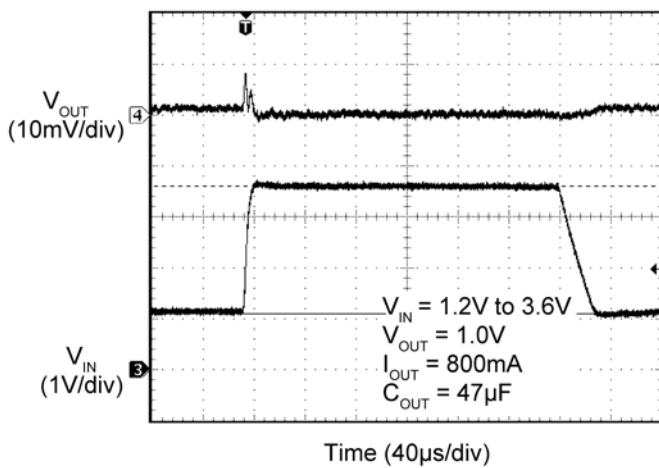

Functional Diagram

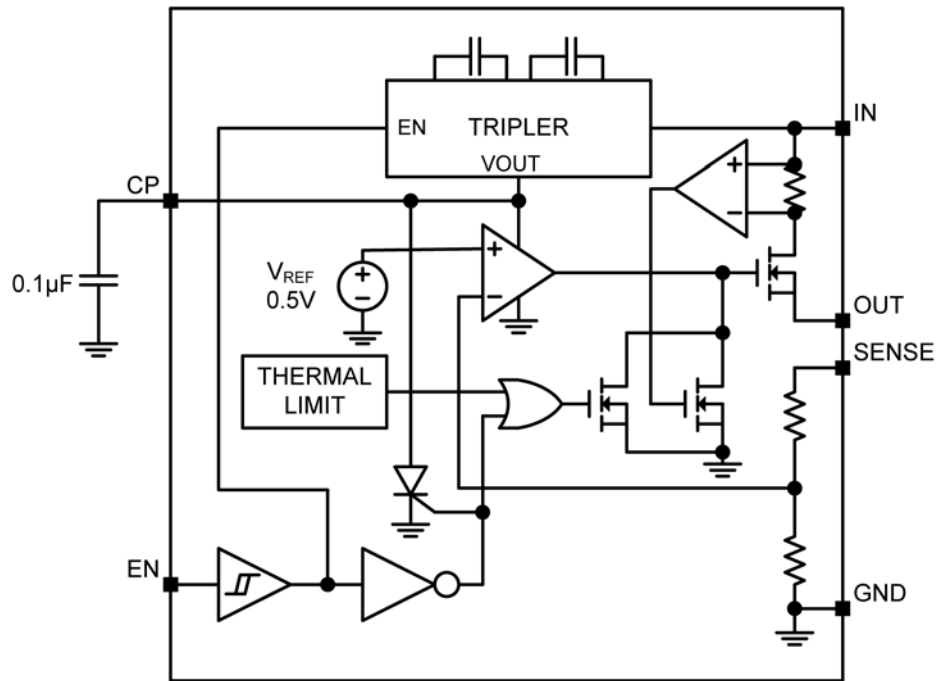

Figure 1. MIC61300 Block Diagram – Fixed

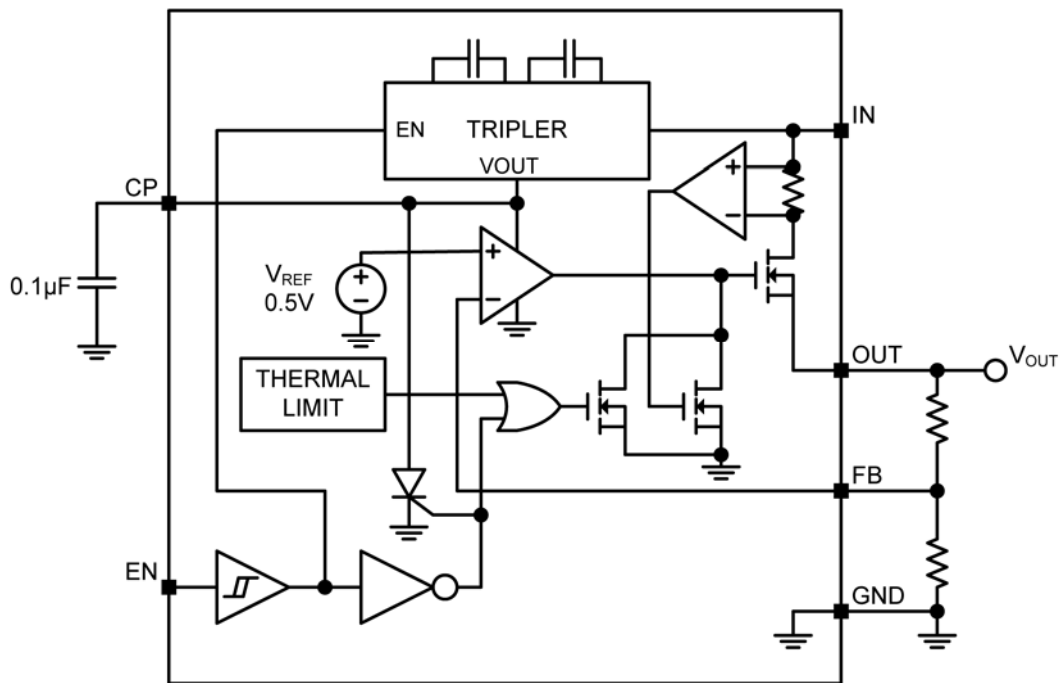

Figure 2. MIC61300 Block Diagram – Adjustable

Functional Description

The MIC61300 is an ultra-high-performance, low-dropout linear regulator designed for high-current applications that require low input voltage operation. The MIC61300 operates from a single input supply and generates an internal supply that is higher than the input voltage to drive an on-chip N-Channel MOSFET. The N-Channel MOSFET significantly reduces the dropout voltage when compared to a traditional P-Channel MOSFET.

P-Channel MOSFETs are usually used in single-supply low-dropout linear voltage regulators. However, for input voltages below 1.5V, there is not sufficient gate drive to turn on the P-Channel. To solve this issue, the MIC61300 uses a simple internal charge pump to drive the internal N-Channel MOSFET's gate higher than the input voltage, see Functional Diagram. The N-Channel MOSFET greatly reduces the dropout voltage for the same die area when compared to that of a P-Channel. Other added benefits of the charge pump include the ability to control the output voltage rise time and to improve the power supply rejection ratio (PSRR). This is accomplished by using the V_{CP} supply to power the error amplifier.

The other significant advantage of the MIC61300 over a P-Channel regulator is its transient response. The N-Channel in the follower configuration is much faster than its P-channel counter part and is simpler to compensate. Any type of output capacitor can be placed in parallel with it as long as the minimum value output ceramic capacitor is placed next to the MIC61300. See the *Output Capacitor* section for specific details. Also, the regulator is fully protected from damage due to fault conditions by offering linear current limiting and thermal shutdown.

Soft-Start

Soft-start reduces the power supply input surge current at startup by controlling the output voltage rise time. The input surge appears while the output capacitor is charged up. A slower output rise time will draw a lower input surge current.

The CP pin is the output of the internal charge pump. The soft-start rise time is controlled by the external capacitor connected from CP pin-to-GND. During soft-start, the charge pump feeds a current to C_{CP} . The output voltage rise time is dependent upon the value of C_{CP} , the input voltage, output voltage and the current limit. The value of the charge pump external capacitor selected is recommended in the range of 0.1 μ F to 1 μ F.

Input Capacitor

A 10 μ F ceramic input capacitor is all that is required for most applications. However, fast load transient and low headroom ($V_{IN} - V_{OUT}$) requires additional bulk bypass capacitance to ensure that the regulator does not drop out of regulation.

The input capacitor must be placed on the same side of the board and next to the MIC61300 to minimize the dropout voltage and voltage ringing during transient and short circuit conditions. It is also recommended to use two vias for each end of the capacitor to connect to the power and ground plane.

X7R or X5R dielectric ceramic capacitors are recommended because of their temperature performance. X7R-type capacitors change capacitance by 15% over their operating temperature range and are the most stable type of ceramic capacitors. Z5U and Y5V dielectric capacitors change value by as much as 50% and 60% respectively over their operating temperature ranges. To use a ceramic chip capacitor with Y5V dielectric, the value must be much higher than an X7R ceramic or a tantalum capacitor to ensure the same capacitance value over the operating temperature range. Tantalum capacitors have a very stable dielectric (10% over their operating temperature range) and can also be used in parallel with the ceramic capacitor(s). See *Typical Characteristics* section for examples of load transient response.

Output Capacitor

As part of the frequency compensation, the MIC61300 requires a 47 μ F ceramic output capacitor. However, any other type of capacitor can be placed in parallel as long as the 47 μ F ceramic output capacitor is placed next to the MIC61300.

Output voltages below 0.8V require either a 100 μ F or 2x 47 μ F output capacitance for large output transients. The increased output capacitance reduces the output voltage drop caused by load transients, which increases as a percentage of the output voltage as the output voltage is lowered.

The output capacitor type and placement criteria are the same as the input capacitor. See the *Input Capacitor* section for a detailed description.

Minimum Load Current

The MIC61300 requires a minimum load of 10mA to maintain output voltage regulation.

Adjustable Regulator Design

The MIC61300 adjustable version allows programming the output voltage from 0.5V to 3.0V by placing a resistor divider network (R1, R2) from V_{OUT} to GND (see Application Circuit). The high side of R1 should be connected at the point-of-load for high-accuracy Kelvin sensing. V_{OUT} is determined by the following equation:

$$V_{OUT} = 0.5 \times \left(\frac{R1}{R2} + 1 \right) \quad \text{Eq. 1}$$

where V_{OUT} is the desired output voltage.

The resistor (R2) value between the FB pin and GND is selected to maintain a minimum 10mA load on the output.

The resistor values are calculated from the previous equation, resulting in the following:

$$R1 = R2 \times \left(\frac{V_{OUT}}{0.5} - 1 \right) \quad \text{Eq. 2}$$

Table 1 is a list of resistor combinations to set the output voltage. A 1% tolerance is recommended for both R1 and R2. For a unity gain, 0.5V output voltage, connect the FB pin directly to the output.

V_{OUT}	R1	R2
0.5V	–	49.9 Ω
0.6V	10.0 Ω	49.9 Ω
0.7V	20.0 Ω	49.9 Ω
0.8V	30.1 Ω	49.9 Ω
0.9V	40.2 Ω	49.9 Ω
1.0	49.9 Ω	49.9 Ω
1.1V	60.4 Ω	49.9 Ω
1.2V	69.8 Ω	49.9 Ω
1.5V	100 Ω	49.9 Ω
1.8V	130 Ω	49.9 Ω
2.2V	169 Ω	49.9 Ω

Table 1. Resistor Selection for Specific V_{OUT}

Thermal Design

Linear regulators are simple to use. The most complicated design parameters to consider are thermal characteristics. To help reduce the thermal resistance, the ePad (underneath the IC) should be soldered to the PCB ground and the placement of thermal vias either underneath or near the ePad is highly recommended. Thermal design requires the following application-specific parameters:

- Maximum ambient temperature (T_A)
- Output current (I_{OUT})
- Output voltage (V_{OUT})
- Input voltage (V_{IN})
- Ground current (I_{GND})

First, calculate the power dissipation of the regulator from these numbers and the device parameters from this datasheet:

$$P_D = (V_{IN} - V_{OUT}) \times I_{OUT} + (V_{IN} \times I_{GND}) \quad \text{Eq. 3}$$

where the ground current is approximated by using numbers from the *Electrical Characteristics* or *Typical Characteristics* sections

For example, given an expected maximum ambient temperature (T_A) of 75°C with $V_{IN} = 1.2V$, $V_{OUT} = 0.9V$, and $I_{OUT} = 1.5A$, first calculate the expected P_D using Equation 1:

$$\begin{aligned} P_D &= (1.2V - 0.9V) \times 1.5A + 1.2V \times 0.015A \\ &= 0.468W \end{aligned} \quad \text{Eq. 4}$$

Next, determine the junction temperature for the expected power dissipation above using the thermal resistance (θ_{JA}) of the 10-pin 3mm \times 3mm MLF[®] (YML) adhering to the following criteria for the PCB design:

1oz. copper and 100mm² copper area for the MIC61300.

$$\begin{aligned} T_J &= (\theta_{JA} \times P_D) + T_A \\ &= (60.7^\circ\text{C/W} \times 0.468W) + 75^\circ\text{C} \\ &= 103.4^\circ\text{C} \end{aligned} \quad \text{Eq. 5}$$

To determine the maximum power dissipation allowed that would not exceed the IC's maximum junction temperature (125°C) when operating at a maximum ambient temperature of 75°C by:

$$\begin{aligned} P_{D(\text{MAX})} &= (T_{J(\text{MAX})} - T_A) / \theta_{JA} \\ &= (125^\circ\text{C} - 75^\circ\text{C}) / (60.7^\circ\text{C}/\text{W}) \\ &= 0.824\text{W} \end{aligned} \quad \text{Eq. 6}$$

Thermal Measurements

It is always wise to measure the IC's case temperature to make sure that it is within its operating limits. Although this might seem like a very elementary task, it is very easy to get erroneous results. The most common mistake is to use the standard thermal couple that comes with the thermal voltage meter. This thermal couple wire gauge is large, typically 22 gauge, and behaves like a heatsink, resulting in a lower case measurement.

There are two suggested methods for measuring the IC case temperature: a thermal couple or an infrared thermometer. If a thermal couple is used, it must be constructed of 36 gauge wire or higher to minimize the wire heatsinking effect. In addition, the thermal couple tip must be covered in either thermal grease or thermal glue to make sure that the thermal couple junction is making good contact to the case of the IC. This thermal couple from Omega (5SC-TT-K-36-36) is adequate for most applications.

To avoid this messy thermal couple grease or glue, an infrared thermometer is recommended. Most infrared thermometers' spot size are too large for an accurate reading on small form factor ICs. However, an IR thermometer from Optris has a 1mm spot size, which makes it ideal for the 3mm × 3mm MLF[®] package. Also, get the optional stand. The stand makes it easy to hold the beam on the IC for long periods of time.

Enable

The MIC61300 features an active high enable input (EN) that allows ON/OFF control of the regulator. The current through the device reduces to near "zero" when the device is shutdown, with only microamperes of leakage current. The EN input may be directly tied to V_{IN} or driven by a voltage that is higher than V_{IN} as long as the voltage does not exceed the maximum operating rating of the EN pin.

MIC61300YML Evaluation Board Schematic (3mm × 3mm 10-Pin ePad MLF[®])

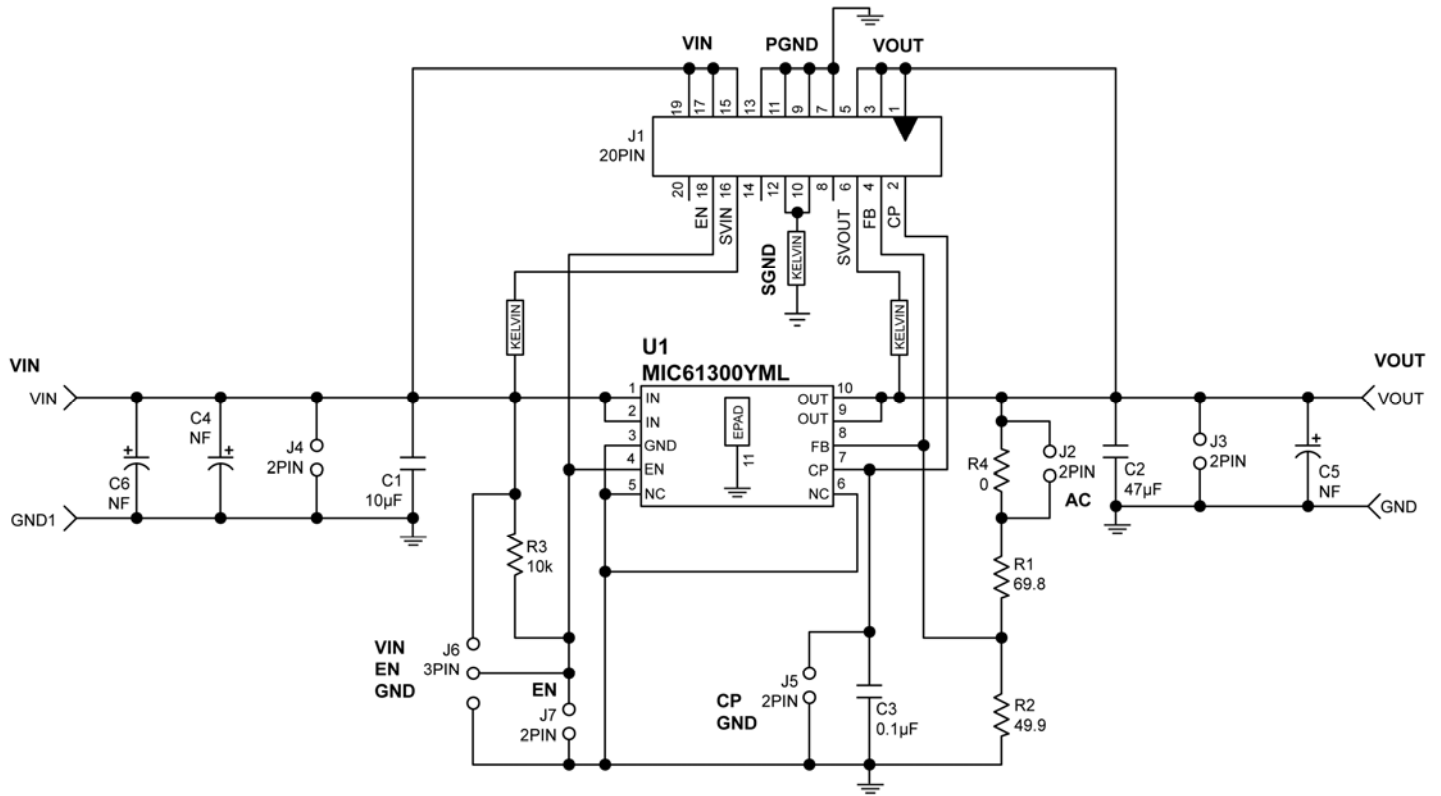

Bill of Materials

Item	Part Number	Manufacturer	Description	Qty.
C1	C0805ZD106KAT2A	AVX ⁽¹⁾	10µF/10V Ceramic Capacitor, X5R, Size 0805	1
C2	C3216X5ROJ476M	TDK ⁽²⁾	47µF/6.3V Ceramic Capacitor, X5R, Size 1206 or	1
	GRM31Cr60J476ME19L	Murata ⁽³⁾	47µF/6.3V Ceramic Capacitor, X5R, Size 1206 or	
	12066D476MAT2A	AVX ⁽¹⁾	47µF/6.3V Ceramic Capacitor, X5R, Size 1206	
C3	C06035C104KAT2A	AVX ⁽¹⁾	0.1µF/50V Ceramic Capacitor, X7R, Size 0603	1
	GRM188R71H104KA93D	Murata ⁽³⁾	0.1µF/50V Ceramic Capacitor, X7R, Size 0603	
R1	CRCW080569R8F	Vishay ⁽⁵⁾	69.8Ω Film Resistor, Size 0805, 1%	1
R2	CRCW080549R9F	Vishay ⁽⁵⁾	49.9Ω Film Resistor, Size 0805, 1%	1
R3	CRCW08051002F	Vishay ⁽⁵⁾	10kΩ Film Resistor, Size 0805, 1%	1
R4	CRCW080500R0F	Vishay ⁽⁵⁾	0Ω Film Resistor, Size 0805, 1%	1
U1	MIC61300YML	Micrel, Inc. ⁽⁶⁾	3A Low-Voltage, Single-Supply LDO	1

Notes:

1. AVX: www.avx.com.
2. TDK: www.tdk.com.
3. Murata: www.murata.com.
4. Vishay: www.vishay.com.
5. Micrel, Inc.: www.micrel.com.

MIC61300YML PCB Layout Recommendations

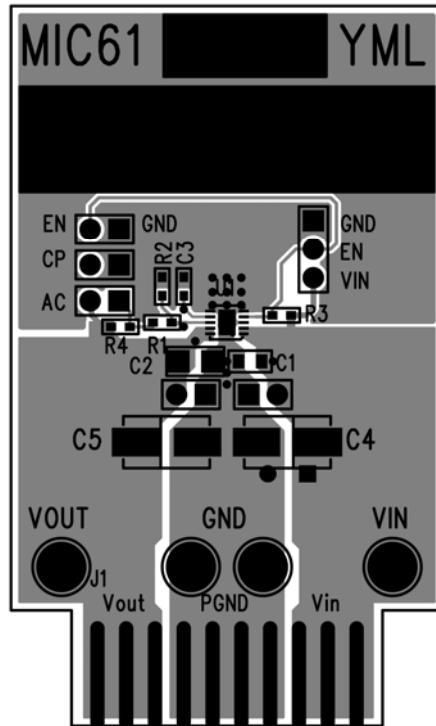

MIC61300YML Evaluation Board – Top Layer

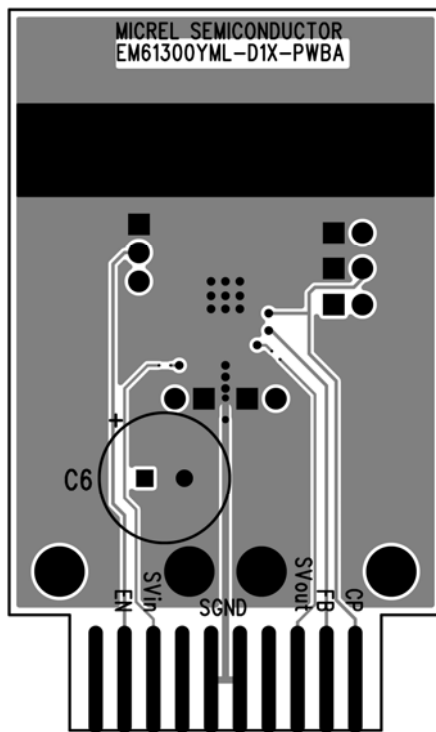

MIC61300YML Evaluation Board – Bottom Layer

MIC61300YMME Evaluation Board Schematic (10-Pin ePad MSOP)

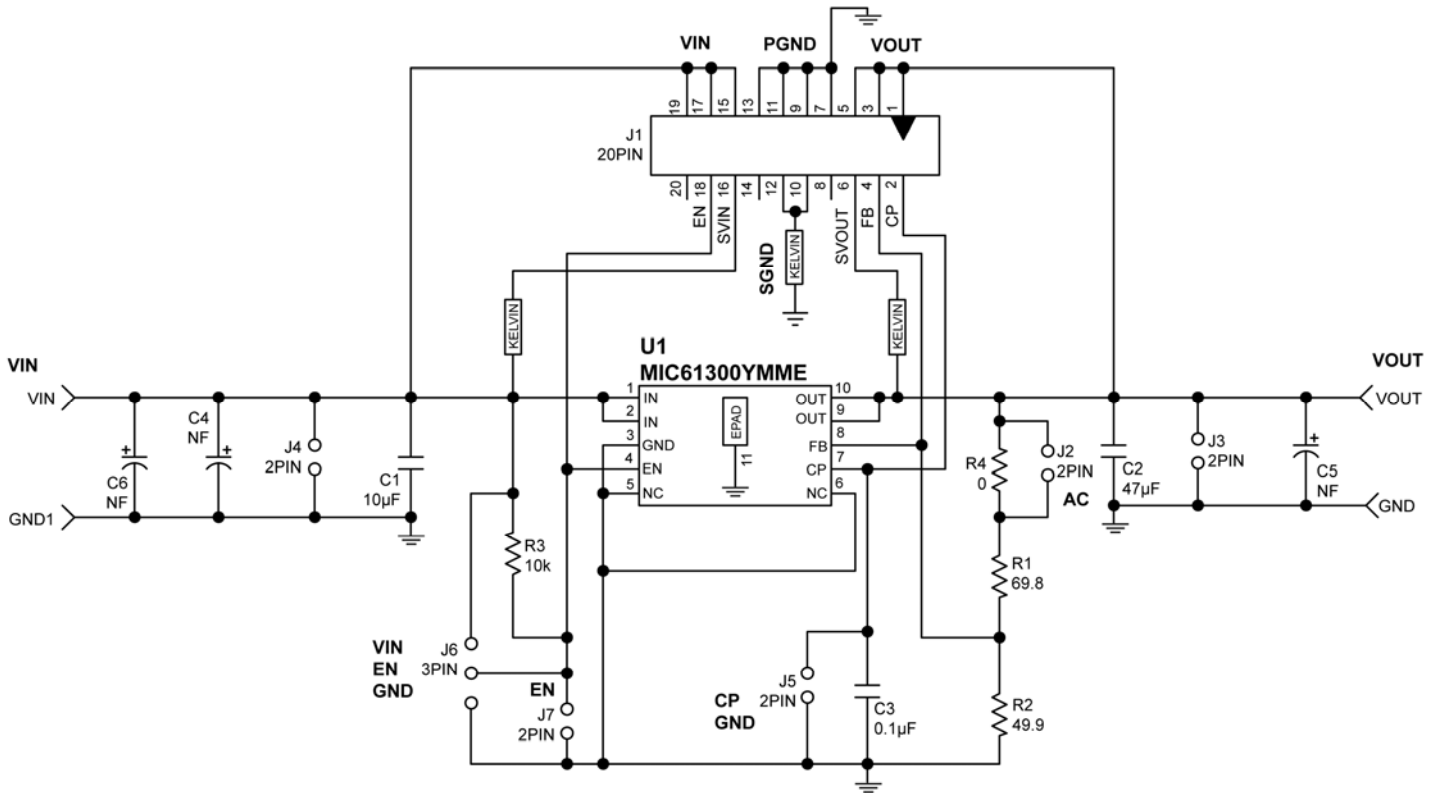

Bill of Materials

Item	Part Number	Manufacturer	Description	Qty.
C1	C0805ZD106KAT2A	AVX ⁽¹⁾	10µF/10V Ceramic Capacitor, X5R, Size 0805	1
C2	C3216X5ROJ476M	TDK ⁽²⁾	47µF/6.3V Ceramic Capacitor, X5R, Size 1206 or	1
	GRM31Cr60J476ME19L	Murata ⁽³⁾	47µF/6.3V Ceramic Capacitor, X5R, Size 1206 or	
	12066D476MAT2A	AVX ⁽¹⁾	47µF/6.3V Ceramic Capacitor, X5R, Size 1206	
C3	C06035C104KAT2A	AVX ⁽¹⁾	0.1µF/50V Ceramic Capacitor, X7R, Size 0603	1
	GRM188R71H104KA93D	Murata ⁽³⁾	0.1µF/50V Ceramic Capacitor, X7R, Size 0603	
R1	CRCW080569R8F	Vishay ⁽⁵⁾	69.8Ω Film Resistor, Size 0805, 1%	1
R2	CRCW080549R9F	Vishay ⁽⁵⁾	49.9Ω Film Resistor, Size 0805, 1%	1
R3	CRCW08051002F	Vishay ⁽⁵⁾	10kΩ Film Resistor, Size 0805, 1%	1
R4	CRCW080500R0F	Vishay ⁽⁵⁾	0Ω Film Resistor, Size 0805, 1%	1
U1	MIC61300YMME	Micrel, Inc.⁽⁶⁾	3A Low-Voltage, Single-Supply LDO	1

Notes:

1. AVX: www.avx.com.
2. TDK: www.tdk.com.
3. Murata: www.murata.com.
4. Vishay: www.vishay.com.
5. **Micrel, Inc.:** www.micrel.com

MIC61300YMME PCB Layout Recommendations

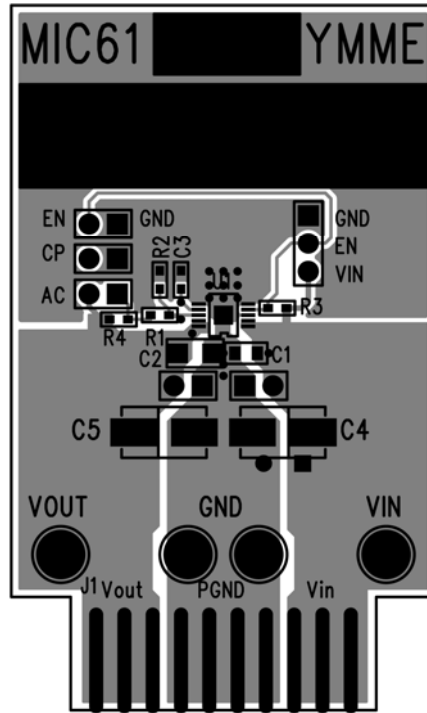

MIC61300YMME Evaluation Board – Top Layer

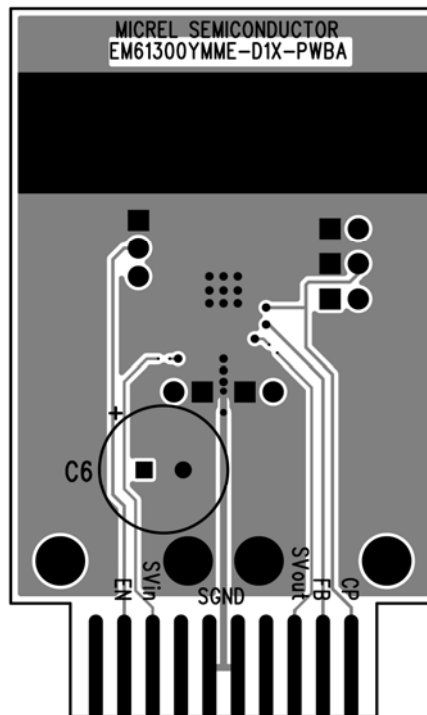

MIC61300YMME Evaluation Board – Bottom Layer

Package Information

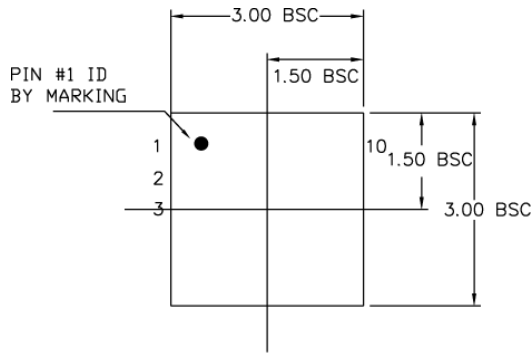

TOP VIEW

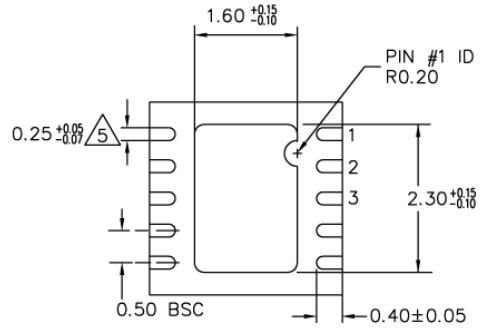

BOTTOM VIEW

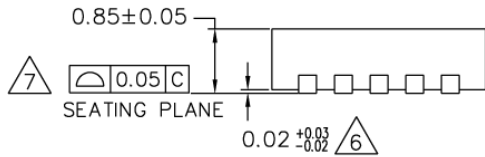

SIDE VIEW

NOTE:

1. ALL DIMENSIONS ARE IN MILLIMETERS.
 2. MAX. PACKAGE WARPAGE IS 0.05 mm.
 3. MAXIMUM ALLOWABLE BURRS IS 0.076 mm IN ALL DIRECTIONS.
 4. PIN #1 ID ON TOP WILL BE LASER/INK MARKED.
- DIMENSION APPLIES TO METALIZED TERMINAL AND IS MEASURED BETWEEN 0.20 AND 0.25 mm FROM TERMINAL TIP.
 APPLIED ONLY FOR TERMINALS.
 APPLIED FOR EXPOSED PAD AND TERMINALS.

10-Pin 3mm x 3mm MLF[®] (ML)

Package Information (Continued)

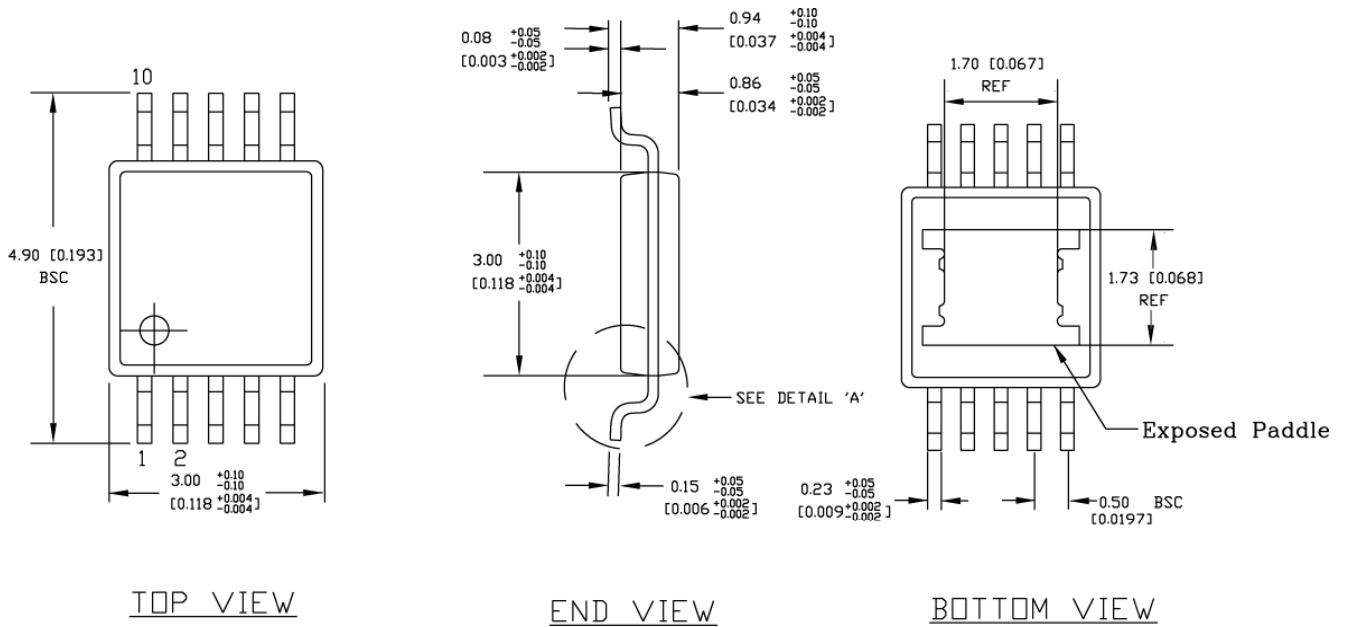

NOTES:

1. DIMENSIONS ARE IN MM [INCHES].
2. CONTROLLING DIMENSION: MM
3. DIMENSION DOES NOT INCLUDE MOLD FLASH OR PROTRUSIONS, EITHER OF WHICH SHALL NOT EXCEED 0.20 [0.008] PER SIDE.

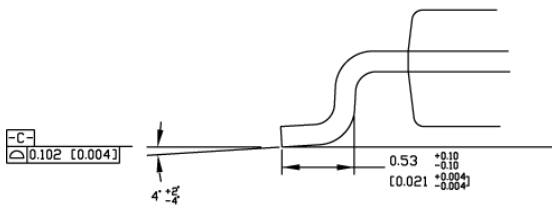

DETAIL A

10-Pin e-PAD MSOP (MME)

Landing Pattern

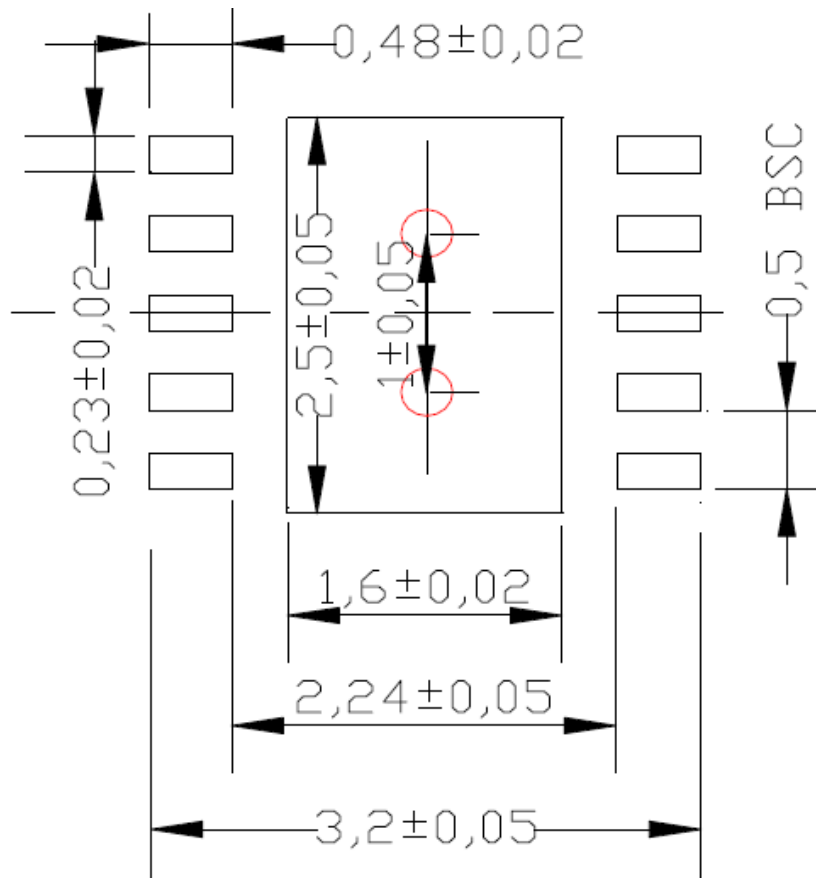

10-Pin 3mm x 3mm MLF[®] (ML)

Landing Pattern (Continued)

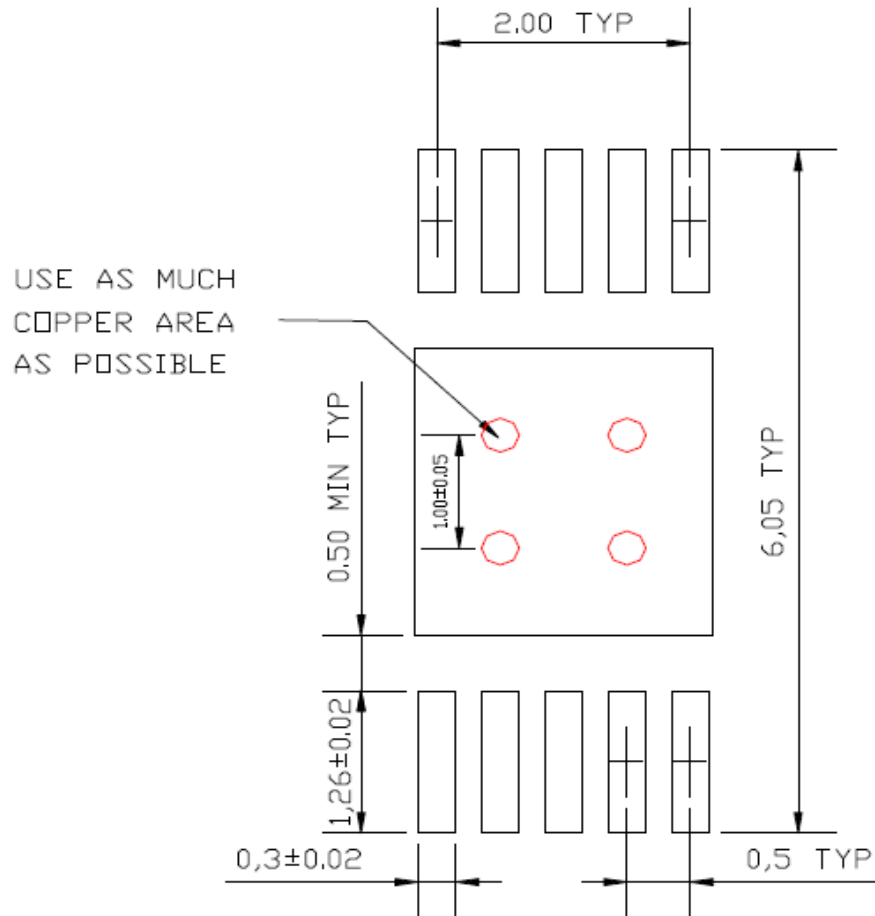

10-Pin e-PAD MSOP (ME)

MICREL, INC. 2180 FORTUNE DRIVE SAN JOSE, CA 95131 USA
 TEL +1 (408) 944-0800 FAX +1 (408) 474-1000 WEB <http://www.micrel.com>

Micrel makes no representations or warranties with respect to the accuracy or completeness of the information furnished in this data sheet. This information is not intended as a warranty and Micrel does not assume responsibility for its use. Micrel reserves the right to change circuitry, specifications and descriptions at any time without notice. No license, whether express, implied, arising by estoppel or otherwise, to any intellectual property rights is granted by this document. Except as provided in Micrel's terms and conditions of sale for such products, Micrel assumes no liability whatsoever, and Micrel disclaims any express or implied warranty relating to the sale and/or use of Micrel products including liability or warranties relating to fitness for a particular purpose, merchantability, or infringement of any patent, copyright or other intellectual property right.

Micrel Products are not designed or authorized for use as components in life support appliances, devices or systems where malfunction of a product can reasonably be expected to result in personal injury. Life support devices or systems are devices or systems that (a) are intended for surgical implant into the body or (b) support or sustain life, and whose failure to perform can be reasonably expected to result in a significant injury to the user. A Purchaser's use or sale of Micrel Products for use in life support appliances, devices or systems is a Purchaser's own risk and Purchaser agrees to fully indemnify Micrel for any damages resulting from such use or sale.

© 2010 Micrel, Incorporated.