

## Common mode filters/Chokes

### Automotive signal line (for power train/safety)

#### ACT series



AEC-Q200

# ACT1210D type



## FEATURES

- Common mode chokes for automotive CAN/CAN-FD system, compatible with an operating temperature range of  $-40$  to  $+150^{\circ}\text{C}$ . (Target product name : ACT1210D-510/ACT1210D-101)
- This product achieves high S-parameter while realizing high reliability by metallizing terminals and laser welding using a proprietary method.
- Operating temperature range:  $-40$  to  $+150^{\circ}\text{C}$  (ACT1210D-510/ACT1210D-101)  
 $-40$  to  $+125^{\circ}\text{C}$  (ACT1210D-131)
- Compliant with AEC-Q200

## APPLICATION

- CAN FD system

## PART NUMBER CONSTRUCTION

ACT1210D	-	101	-	2P	-	TL	-	00
Series • type name		Inductance(typ.) ( $\mu\text{H}$ )		Number of lines		Packaging style		Internal code

## CHARACTERISTICS SPECIFICATION TABLE

Common mode inductance [100kHz] ( $\mu\text{H}$ )	Tolerance	DC resistance $-40$ to $+125^{\circ}\text{C}$ ( $\Omega$ )max.	Insulation resistance ( $\text{M}\Omega$ )min.	Rated current (mA)max.	Rated voltage (V)max.	Part No.
51	+50/-30%	3.0	10	115	80	<a href="#">ACT1210D-510-2P-TL00</a>
100	+50/-30%	3.0	10	115	80	<a href="#">ACT1210D-101-2P-TL00</a>
130	+50/-30%	3.5	10	115	80	<a href="#">ACT1210D-131-2P-TL00</a>

### Rated current temperature characteristics (Derating)

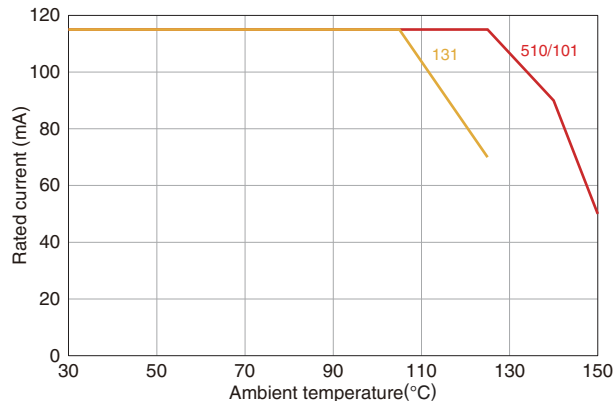

### Measurement equipment

Measurement item	Product No.	Manufacturer
Common mode inductance	4294A	Keysight Technologies
DC resistance	4338A	Keysight Technologies
Insulation resistance	4339A	Keysight Technologies

\* Equivalent measurement equipment may be used.



⚠ Please be sure to request delivery specifications that provide further details on the features and specifications of the products for proper and safe use. (1/4)  
Please note that the contents may change without any prior notice due to reasons such as upgrading.

20220930

cmf\_automotive\_signal\_act1210d\_en

# ACT1210D type

■ Sdd21

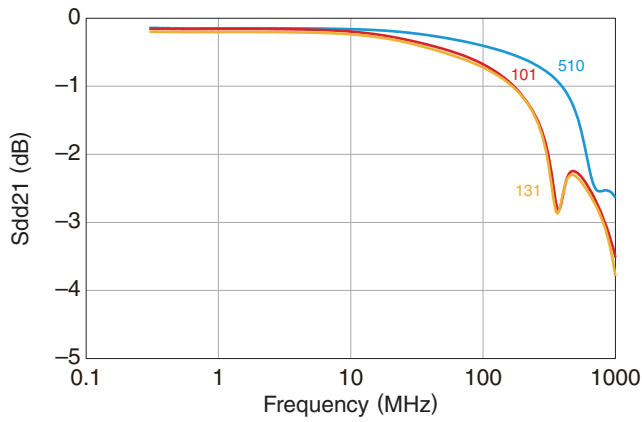

■ Scc21

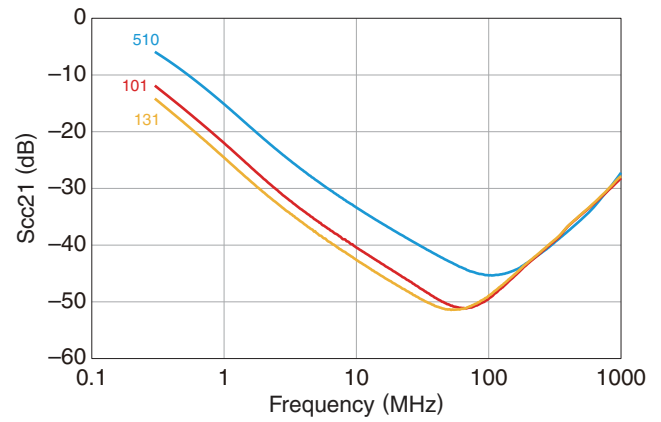

■ Ssd21

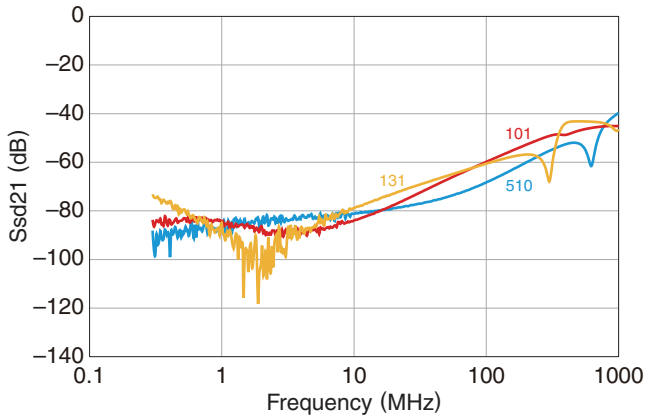

■ Ssd12

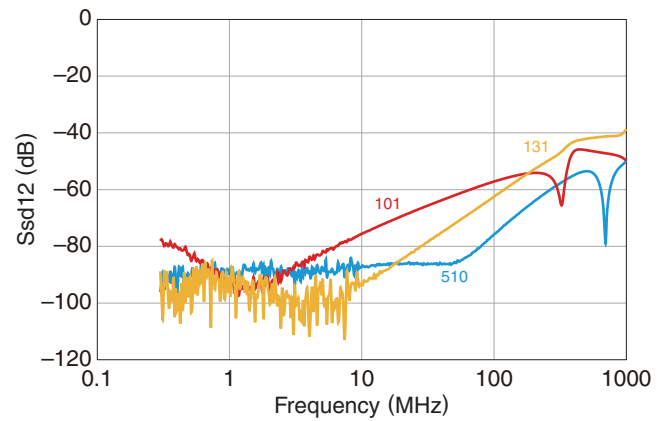

Measurement equipment

Product No.	Manufacturer
E5071C	Keysight Technologies

\* Equivalent measurement equipment may be used.

# ACT1210D type

## SHAPE & DIMENSIONS

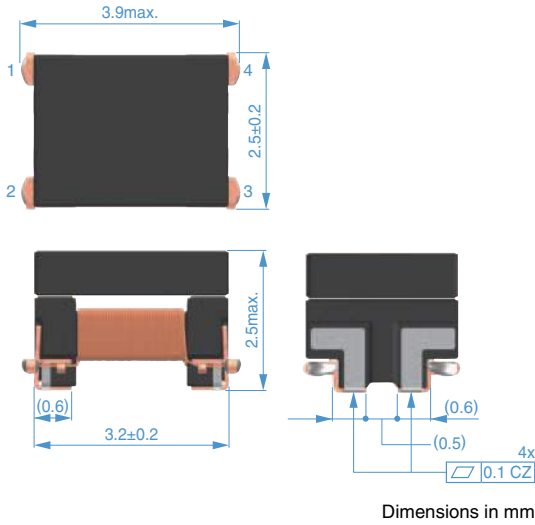

## PACKAGING STYLE

### REEL DIMENSIONS

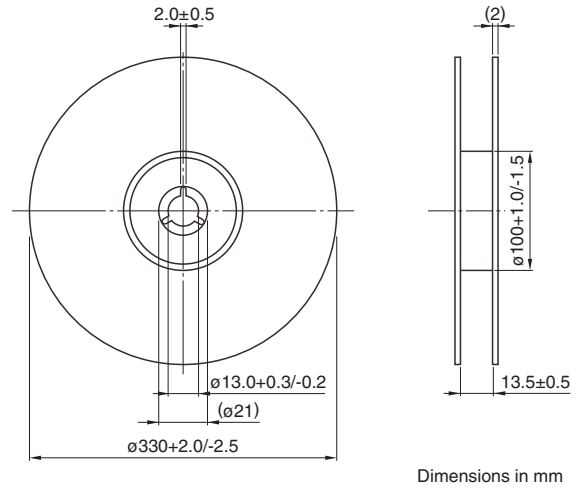

## RECOMMENDED LAND PATTERN

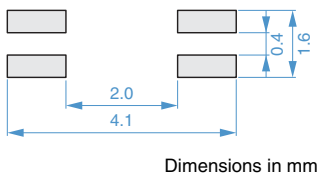

### TAPE DIMENSIONS

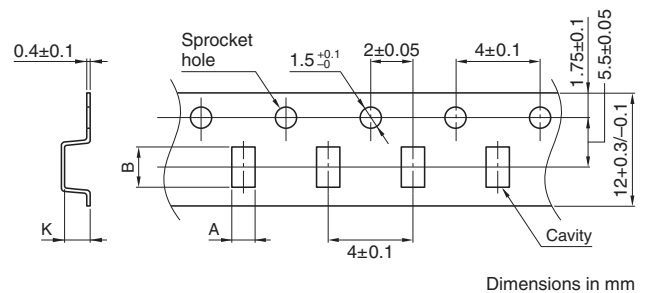

## CIRCUIT DIAGRAM

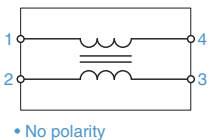

Type	A	B	K
ACT1210D	(2.85)	(4.2)	(2.7)

### PACKAGE QUANTITY

Package quantity	6,000 pcs/reel
------------------	----------------

## RECOMMENDED REFLOW PROFILE

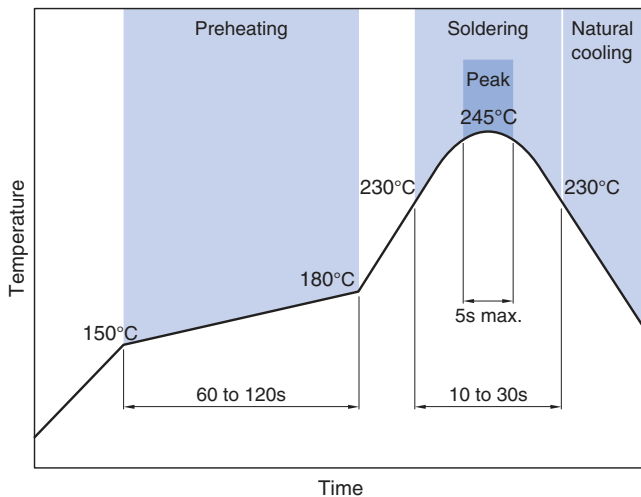

## TEMPERATURE RANGE, INDIVIDUAL WEIGHT

Part number	Operating temperature range	Individual weight
ACT1210D-510	-40 to +150°C	0.075 g
ACT1210D-101	-40 to +150°C	0.075 g
ACT1210D-131	-40 to +125°C	0.075 g

## REMINDERS FOR USING THESE PRODUCTS

Before using these products, be sure to request the delivery specifications.

### SAFETY REMINDERS

Please pay sufficient attention to the warnings for safe designing when using this products.

#### REMINDERS

- The storage period is within 12 months. Be sure to follow the storage conditions (temperature: 5 to 40°C, humidity: 10 to 75% RH or less).  
If the storage period elapses, the soldering of the terminal electrodes may deteriorate.
- Do not use or store in locations where there are conditions such as gas corrosion (salt, acid, alkali, etc.).
- Soldering corrections after mounting should be within the range of the conditions determined in the specifications.  
If overheated, a short circuit, performance deterioration, or lifespan shortening may occur.
- When embedding a printed circuit board where a chip is mounted to a set, be sure that residual stress is not given to the chip due to the overall distortion of the printed circuit board and partial distortion such as at screw tightening portions.
- Self heating (temperature increase) occurs when the power is turned ON, so the tolerance should be sufficient for the set thermal design.
- Carefully lay out the coil for the circuit board design of the non-magnetic shield type.  
A malfunction may occur due to magnetic interference.
- Use a wrist band to discharge static electricity in your body through the grounding wire.
- Do not expose the products to magnets or magnetic fields.
- Do not use products that have received any excessive mechanical shock such as by being dropped.
- The performance of the product may deteriorate or at the worst case open if coating materials are used, thus please assess the situation beforehand by taking this factor into consideration.
- Due to the application of mechanical stress after mounting and handling such as contact, disconnection may occur.
- Do not use for a purpose outside of the contents regulated in the delivery specifications.
- The products listed on this specification sheet (the "Products") are intended for incorporation into automobile and/or equipment to be installed in automobile on the grounds that (i) the Products are used in accordance with the conditions and scope stated in this specification sheet and (ii) said automobile and/or equipment involving the Products are used under a normal operation and use condition.  
Except for said incorporation into automobile and/or equipment installed in automobile, the Products are not designed or warranted to meet the requirements of the applications listed below, whose performance and/or quality require a more stringent level of safety or reliability, or whose failure, malfunction or trouble could cause serious damage to society, person or property. Please understand that we are not responsible for any damage or liability caused by use of the Products in any of the applications listed below or for any other use exceeding the range or conditions set forth in this specification sheet. If you intend to use the Products beyond the condition and scope of this specification sheet or in any of the applications listed below, please contact with our sales office. We will separately discuss with you applicable specification suitable for your intended use:

- 1) Aerospace/Aviation equipment,
- 2) Transportation equipment (e.g. train, ship),
- 3) Medical equipment which directly endanger human life,
- 4) Power-generation control equipment,
- 5) Atomic energy-related equipment,
- 6) Seabed equipment,
- 7) Transportation control equipment (e.g. train, ship),

- 8) Public information-processing equipment,
- 9) Military equipment,
- 10) Electric heating apparatus / burning equipment,
- 11) Disaster prevention/crime prevention equipment,
- 12) Safety equipment, or
- 13) Other applications that are not considered general-purpose applications.

When designing your equipment involving the Products, you are kindly requested to take into consideration securing protection circuit/equipment or providing backup circuits, etc. in your equipment, to ensure higher safety.

As stated above, the Products are intended for incorporation into automobile and/or equipment to be installed in automobile, however, it is not prohibited to use the Products for general electronic equipment which is not required the same high level or reliability as automobile, or which is unlikely to damage its users' life, body and property or to cause extensive impact on society. Accordingly, all description in this specification sheet is applied if the Products are incorporated into general electronic equipment which is used for normal application under a normal operation and use condition.