

LOC		DIST		REVISIONS			
P	LTR	DESCRIPTION		DATE	DWN	APVD	
	B	ECR-17-009163		28JUN17	MG	BM	

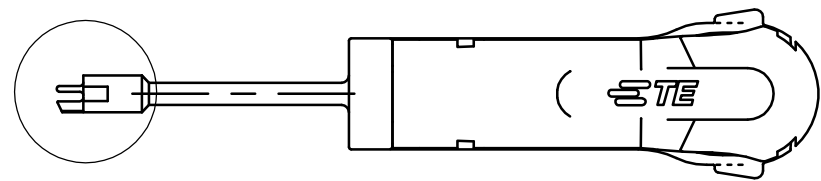

A

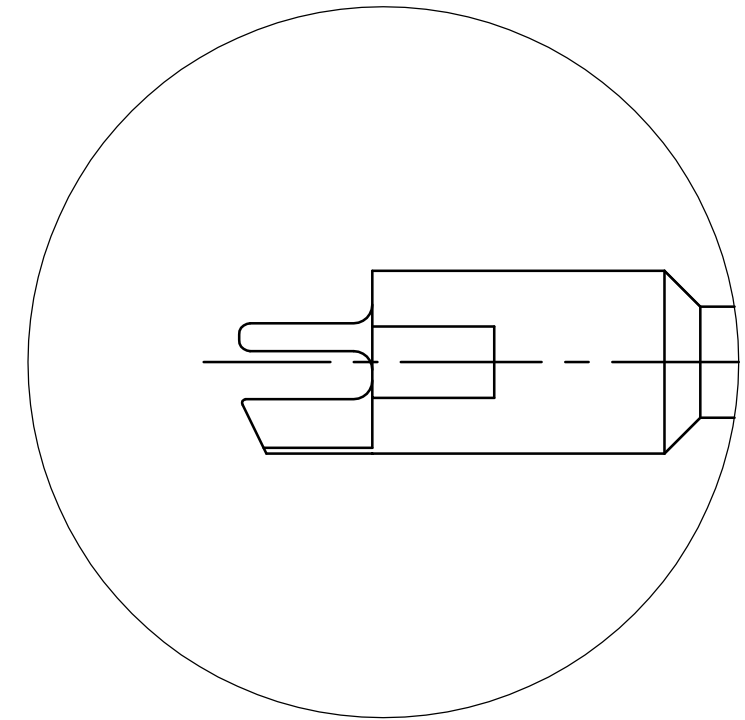

A
5:1

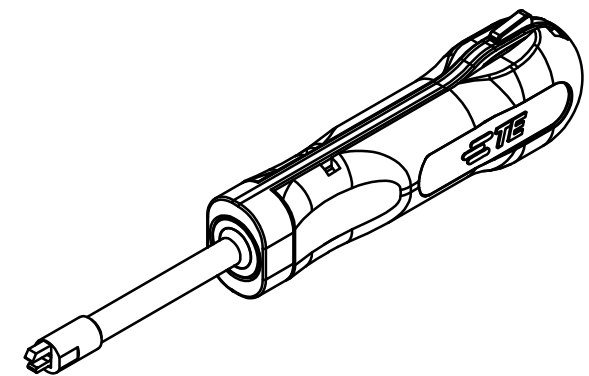
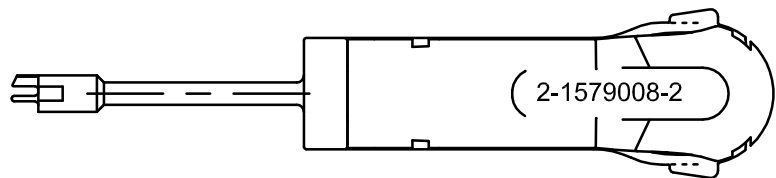
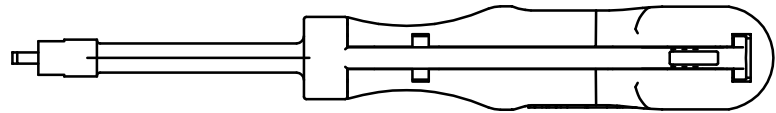

FOR CONTACTS / HOUSINGS:

SICMA 1.5 receptacle with 1 plastic locking latches

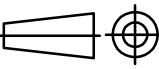
THIS DRAWING IS A CONTROLLED DOCUMENT.		DWN m.pearson	06.11.2006	 TE Connectivity	
DIMENSIONS: mm		CHK -	APVD -		
		TOLERANCES UNLESS OTHERWISE SPECIFIED:		PRODUCT SPEC -	
MATERIAL		FINISH		APPLICATION SPEC -	
				SIZE A3	CAGE CODE 00779
				DRAWING NO 2-1579008-2	
				RESTRICTED TO -	
		WEIGHT 0.017 kg		SCALE 1:1	
		CUSTOMER DRAWING		SHEET 1 OF 1	
				REV B	