

# CTL1206FWH1T DATASHEET

Chip Type LED, 1206, Flat Lens, White



VENKEL LTD.

Part Number	Size	Emitting Color	Emitting Material	Lens-Color	Luminous Intensity ( $I_F=20\text{mA}$ ) mcd	Viewing Angle ( $2\theta$ 1/2)
CTL1206FWH1T	1206	White	InGaN	Yellow Diffused	320 min 600 typ	140°

Electrical & Optical Specifications ( $T_A=25^\circ\text{C}$ )	WH1 (InGaN)	Unit	
Forward Voltage (Min.) ( $I_F=20\text{mA}$ )	$V_F$	2.8	V
Forward Voltage (Max.) ( $I_F=20\text{mA}$ )	$V_F$	3.6	V
Reverse Current (Max) ( $V_R=5\text{V}$ )	$I_R$	50	$\mu\text{A}$
Chromatic Coordinates (Min.) ( $I_F=20\text{mA}$ )	X	0.24	
Chromatic Coordinates (Max.) ( $I_F=20\text{mA}$ )	X	0.28	
Chromatic Coordinates (Min.) ( $I_F=20\text{mA}$ )	Y	0.195	
Chromatic Coordinates (Max.) ( $I_F=20\text{mA}$ )	Y	0.295	

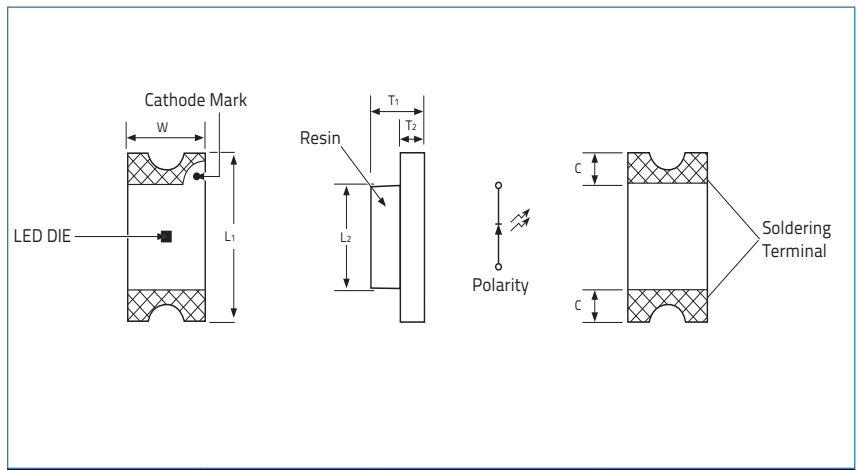

Dimensions		Units: Inches (mm)	
$L_1$	$L_2$	$T_1$	$T_2$
0.126±0.004 (3.2±0.1)	0.079±0.004 (2.0±0.1)	0.0433±0.004 (1.1±0.1)	0.0197±0.004 (0.5±0.1)
W	C		
0.063±0.004 (1.6±0.1)	0.0236±0.004 (0.6±0.1)		

Absolute Maximum Ratings ( $T_A=25^\circ\text{C}$ )	WH1 (InGaN)	Unit	
Reverse Voltage	$V_R$	5	V
DC Forward Current	$I_F$	20	mA
Peak Forward Current 1/10 Duty Cycle @ 10KHz	$I_{FP}$	100	mA
Power Dissipation	$P_D$	72	mW
Operating Temperature	$T_A$	-40 ~ +85	°C
Storage Temperature	Tstg	-40 ~ +100	

## Soldering Pad Layout

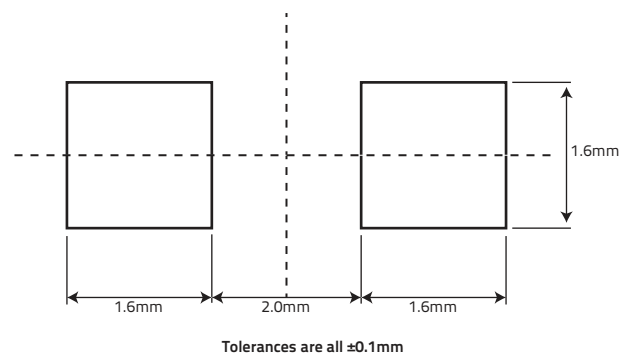

Tolerances are all ±0.1mm

# CTL1206FWH1T DATASHEET

Chip Type LED, 1206, Flat Lens, White



VENKEL LTD.

## Graphs

**Fig.1 Forward Current vs Forward Voltage**

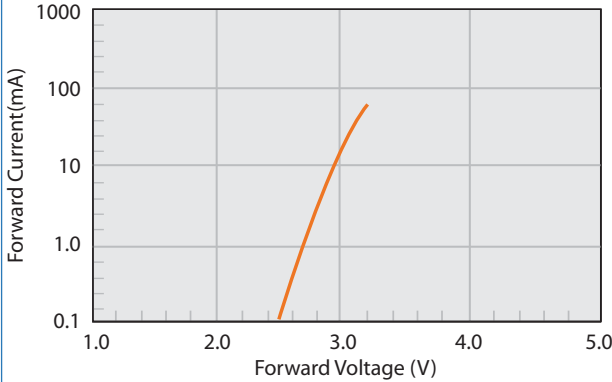

**Fig.2 Relative Intensity vs Forward Current**

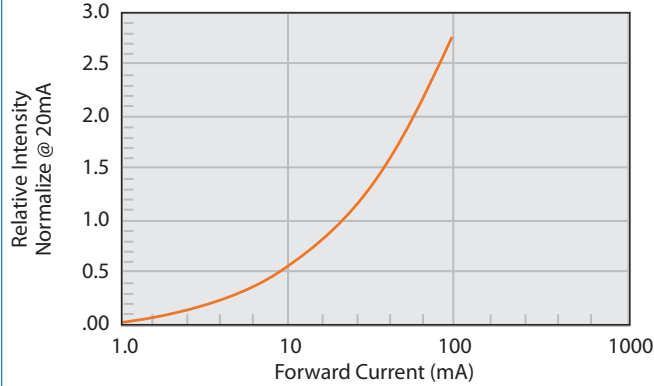

**Fig.3 Current vs Temp**

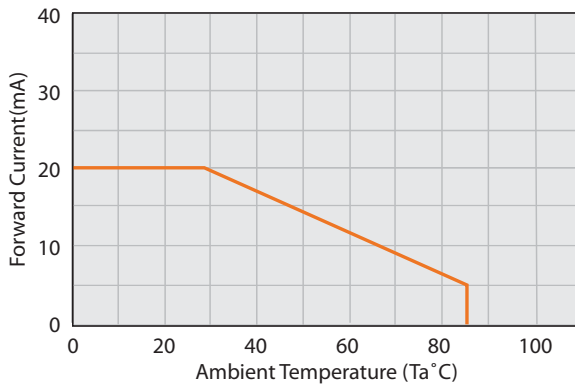

**Fig.4 Relative Intensity vs Temperature**

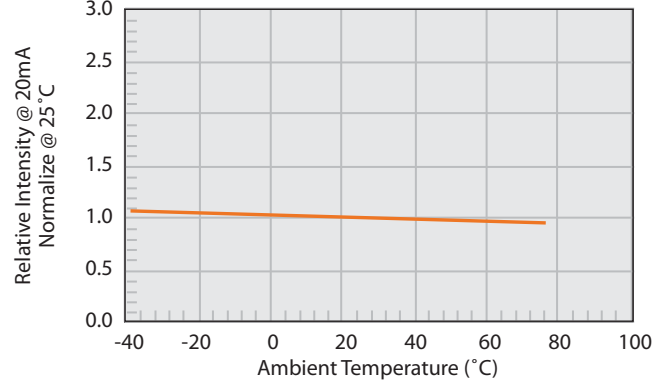

**Fig. 5 Spectral Radiance**

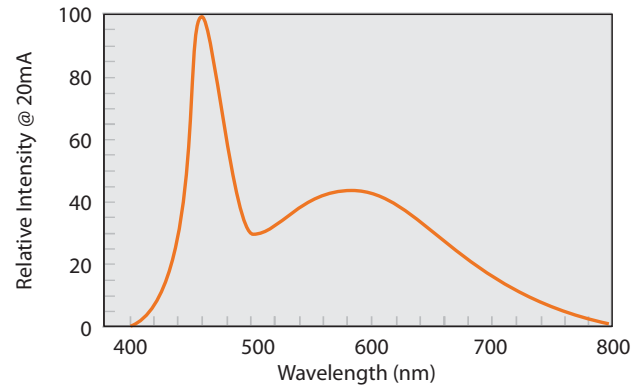

**Fig. 6 Direct Radiation**

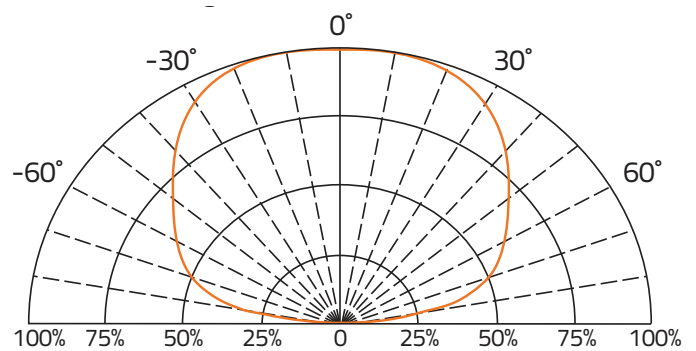

## Environmental information

RoHS Status	6 of 6 Compliant
REACH Status	Compliant
Halogen Status	Halogen Free
Conflict Mineral Status	Conflict Mineral Free
Moisture Sensitivity Level (MSL)	3

## Reflow profile

Max Reflow Temperature	260°C
Number of Reflow Cycles	2

# CTL1206FWH1T DATASHEET

Chip Type LED, 1206, Flat Lens, White



VENKEL LTD.

## Label Example

Item: CTL1206FWH1T

Chip Type LED,1206,Flat Lens,White

Qty: 3000

D/C: 1616

Lot: 20160502001

BIN/HUE: T/B1

VF: 3.0-3.2

**VENKEL LTD**

**YOUR SINGLE SOURCE FOR SURFACE MOUNT PASSIVES**

### Codes:

VF: Forward Voltage | BIN: Luminous Intensity | HUE: Dominant Wavelength

## Luminous Intensity Classification (BIN Code)

BIN Code	Iv(mcd) at 20mA	
	Min.	Max.
T	320	500
U	500	800
V	800	1250

# CTL1206FWH1T DATASHEET

Chip Type LED, 1206, Flat Lens, White



VENKEL LTD.

## CHROMATICITY COORDINATES SPECIFICATIONS FOR HUE GRADING

Color Coordinates at 20mA								
BIN CODE	1		2		3		4	
	X	Y	X	Y	X	Y	X	Y
B1	0.26	0.265	0.26	0.225	0.27	0.24	0.27	0.28
B2	0.27	0.28	0.27	0.24	0.28	0.255	0.28	0.295
B3	0.28	0.295	0.28	0.255	0.29	0.27	0.29	0.31
B4	0.29	0.31	0.29	0.27	0.3	0.285	0.3	0.325
B5	0.3	0.325	0.3	0.285	0.31	0.3	0.31	0.34

## CIE CHROMATICITY DIAGRAM

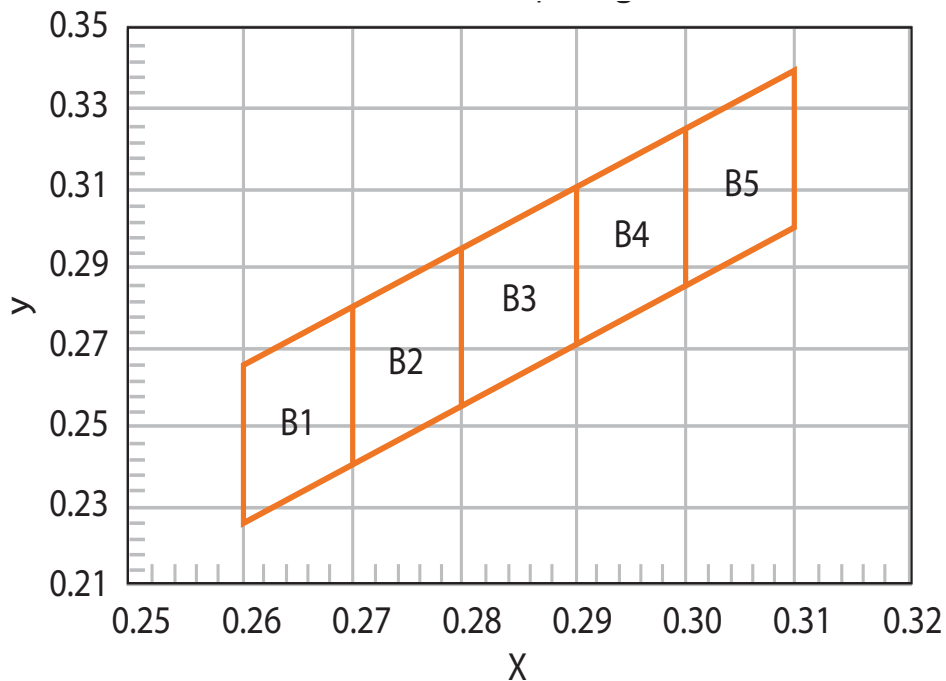

# CTL1206FWH1T DATASHEET

Chip Type LED, 1206, Flat Lens, White



VENKEL LTD.

Reel Specifications		Units: mm		
<b>M</b>	<b>C</b>	<b>F</b>	<b>E</b>	<b>G</b>
178±1.50	56.0±1.0	12.0±1.0	60.0±1.0	9.0±1.0

Packaging Specifications	
Reel Size:	7"
Quantity per Reel :	3,000

Storage Specifications
1. Storage temperature and RH: 5°C~35°C, RH60%
2. Once the package is opened, the LEDs should be used within a week. Otherwise, they should be kept in a moisture proof bag with desiccant. We suggest that you use this product within one year from date code.
3. If opened for more than one week in an atmosphere of 5°C~35°C, RH60%. The parts should be heat treated at 60°C±5°C for 15 hours.

Tape Specifications		Units: mm		
<b>T</b>	<b>W</b>	<b>A</b>	<b>B</b>	<b>F</b>
1.36±0.5	8.0±0.3	3.38±0.5	1.76±0.1	3.5±0.2
<b>E</b>	<b>H</b>	<b>J</b>	<b>D</b>	<b>G</b>
1.75±0.1	4.0±0.2	2.0±0.1	1.5±0.1	4.0±0.2

# CTL1206FWH1T DATASHEET

Chip Type LED, 1206, Flat Lens, White



VENKEL LTD.

## Environmental Test Criteria

Classification	Test Item	Test Condition	Sample Size
Endurance Test	Operating Life	1. $T_a=25^{\circ}\text{C}$ 2. $I_f=20\text{mA}$ 3. $t=1000\text{hrs}$ (-24hrs, +72hrs)	22
	High Temperature Storage	1. $T_a=105^{\circ}\text{C}\pm 5^{\circ}\text{C}$ 2. $t=1000\text{hrs}$ (-24hrs, +72hrs)	22
	Low Temperature Storage	1. $T_a=-40^{\circ}\text{C}\pm 5^{\circ}\text{C}$ 2. $t=1000\text{hrs}$ (-24hrs, +72hrs)	22
	High Temperature, High Humidity Storage	1. $T_a=85^{\circ}\text{C}$ 2. $\text{RH}=85\%$ 3. $t=1000\text{hrs}$ (-24hrs, +72hrs)	22
Environmental Test	Thermal Shock	1. $T_a=100^{\circ}\text{C}\pm 5^{\circ}\text{C}$ & $-40^{\circ}\text{C}\pm 5^{\circ}\text{C}$ 20min / 10sec / 20min 3. Total: 100 cycles total	22
	Temperature Cycling	1. $100^{\circ}\text{C}\pm 5^{\circ}\text{C}$ & $-40^{\circ}\text{C}\pm 5^{\circ}\text{C}$ 30mins / 5mins / 30mins 2. 100 Cycles	22
	IR Reflow	1. $T=260^{\circ}\text{C}$ Max. 10 seconds Max 2. 6 Min	22

## Drive Method

LED is a current operated drive, and therefore it requires some kind of current limiting incorporated into the driver circuit. This current limiting typically takes the form of a current limiting resistor placed in series with the LED. Consider worst case voltage variations that can occur across the current limiting resistor placed in series with the LED. The forward current should not be allowed to change by more than 40% of its desired value.

Circuit model A

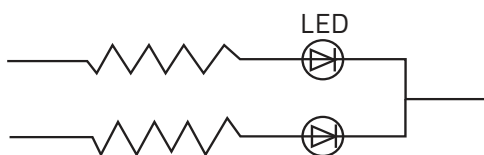

Circuit model B

