

## RITA-A

Asymmetric beam

### SPECIFICATION:

Dimensions	36.0 x 28.4 mm
Height	17.1 mm
Fastening	glue, pin
ROHS compliant	yes ⓘ

### MATERIALS:

Component	Type	Material	Colour	Finish	Coating
RITA-A	Reflector	HRPC	white		

### ORDERING INFORMATION:





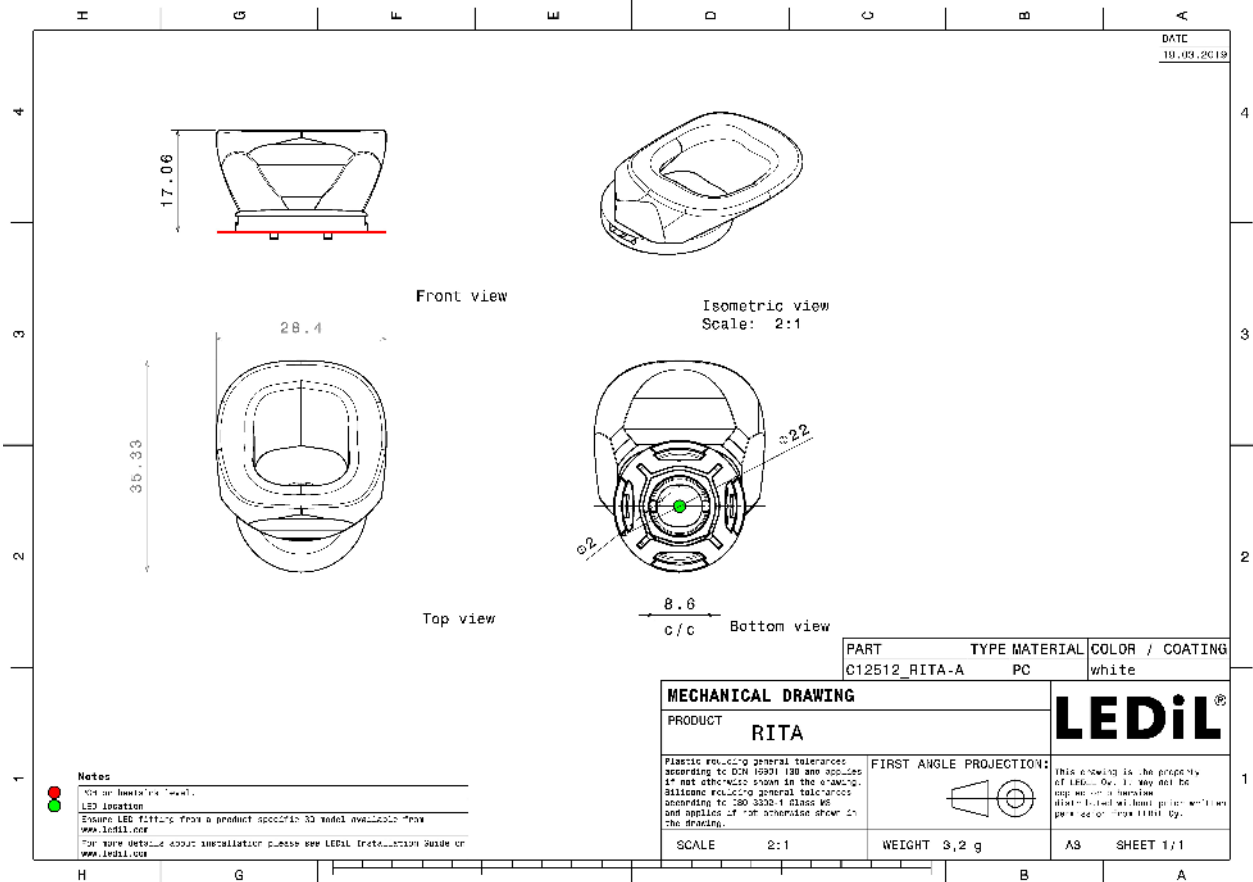

Component	Qty in box	MOQ	MPQ	Box weight (kg)
C12512_RITA-A » Box size: 480 x 280 x 300 mm	810		54	4.2



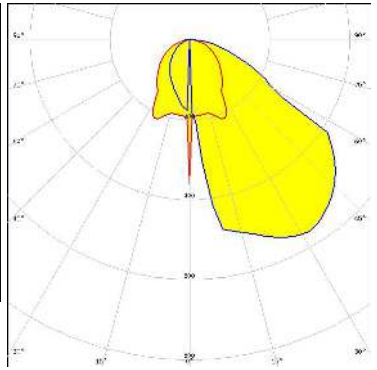

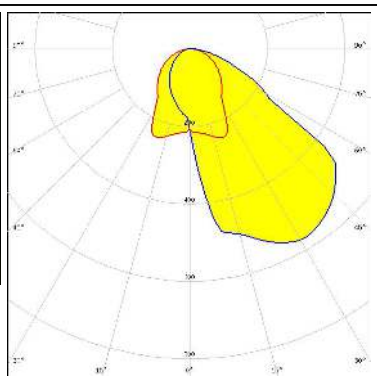

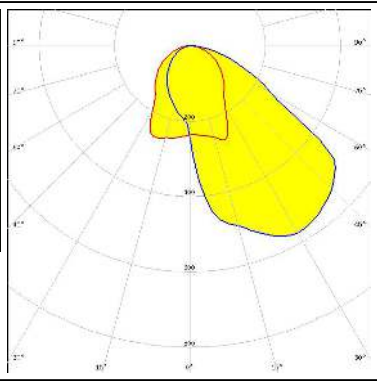

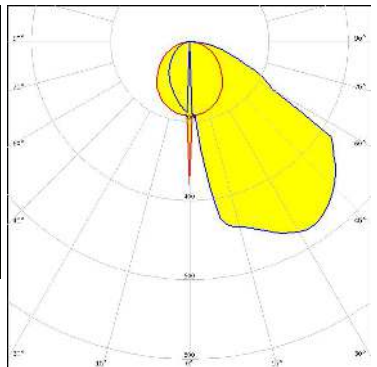
See also our general installation guide: [www.ledil.com/installation\\_guide](http://www.ledil.com/installation_guide)

### OPTICAL RESULTS (MEASURED):

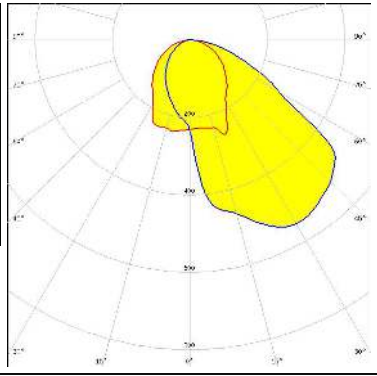
<p><b>CREE</b> ⇄ <b>LED</b></p> <p>LED                    XB-D            FWHM / FWTM    Asymmetric            Efficiency            84 %            LEDs/each optic    1            Light colour        White            Required components:</p>		
<p><b>CREE</b> ⇄ <b>LED</b></p> <p>LED                    XM-L            FWHM / FWTM    Asymmetric            Efficiency            85 %            Peak intensity      0.6 cd/lm            LEDs/each optic    1            Light colour        White            Required components:</p>		
<p><b>CREE</b> ⇄ <b>LED</b></p> <p>LED                    XM-L2            FWHM / FWTM    Asymmetric            Efficiency            86 %            Peak intensity      0.6 cd/lm            LEDs/each optic    1            Light colour        White            Required components:</p>		
<p><b>CREE</b> ⇄ <b>LED</b></p> <p>LED                    XP-G            FWHM / FWTM    Asymmetric            Efficiency            86 %            LEDs/each optic    1            Light colour        White            Required components:</p>		

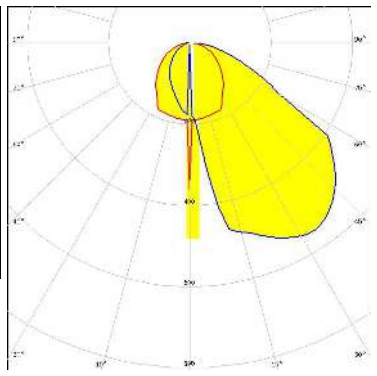
### OPTICAL RESULTS (MEASURED):

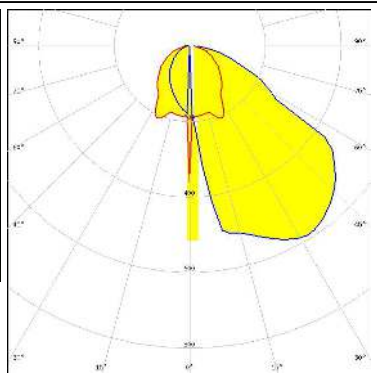
<p><b>CREE</b> LED</p> <p>LED: XP-G2            FWHM / FWTM: Asymmetric            Efficiency: 87 %            Peak intensity: 0.6 cd/lm            LEDs/each optic: 1            Light colour: White            Required components:</p>		
<p><b>CREE</b> LED</p> <p>LED: XT-E            FWHM / FWTM: Asymmetric            Efficiency: 86 %            LEDs/each optic: 1            Light colour: White            Required components:</p>		
<p><b>LUMILEDS</b></p> <p>LED: LUXEON Rebel ES            FWHM / FWTM: Asymmetric            Efficiency: 85 %            LEDs/each optic: 1            Light colour: White            Required components:</p>		

### GENERAL INFORMATION:

NOTE: The typical beam angle will be changed by different color, chip size and chip position tolerance. The typical total beam angle is the full angle measured where the luminous intensity is half of the peak value.

### MATERIALS:

As part of our continuous research and improvement processes, and to ensure the best possible quality and availability of our products, LEDiL reserves the right to change material grades without notice.

### PRODUCT DATA USER AGREEMENT AND DISCLAIMER:

The measured data in the provided downloadable LEDiL Product Datasheets and Mechanical 2D-Drawings is rounded and provided as reference for planning. LEDiL Oy's optical specifications have been verified by conducting performance testing of the products in accordance with the company's quality system. The reported data are averaged results of multiple measurements with typical variation. LEDiL Oy reserves the right to without prior notification make changes and improvements to its products.

LEDiL Oy assumes neither warranty, nor guarantee nor any other liability of any kind for the contents and correctness of the provided data. The provided data has been generated with highest diligence but the provided data may in reality not represent the complete possible variation range of all intrinsic parameters. Therefore, in certain cases a deviation from the provided data could occur.

LEDiL Oy reserves the right to undertake technical changes of its products without further notification which could lead to changes in the provided data. LEDiL Oy assumes no liability of any kind for the possible deviation from any provided data or any other damage resulting from the usage of the provided data.

The user agrees to this disclaimer and user agreement with the download or usage of the provided files.

#### LEDiL Oy

Joensuunkatu 13  
FI-24240 SALO  
Finland

#### LEDiL Inc.

228 West Page Street  
Suite D  
Sycamore IL 60178  
USA

#### Ledil Optics Technology (Shenzhen) Co., Ltd.

# 405 , Block B  
Casic Motor Building  
Shenzhen 518057  
P.R.CHINA

#### Local sales and technical support

[www.ledil.com/  
where\\_to\\_buy](http://www.ledil.com/where_to_buy)

#### Shipping locations

Salo, Finland  
Hong Kong, China

#### Distribution Partners

[www.ledil.com/  
where\\_to\\_buy](http://www.ledil.com/where_to_buy)