

Small / Slim Object Detection Area Sensor NA1-11

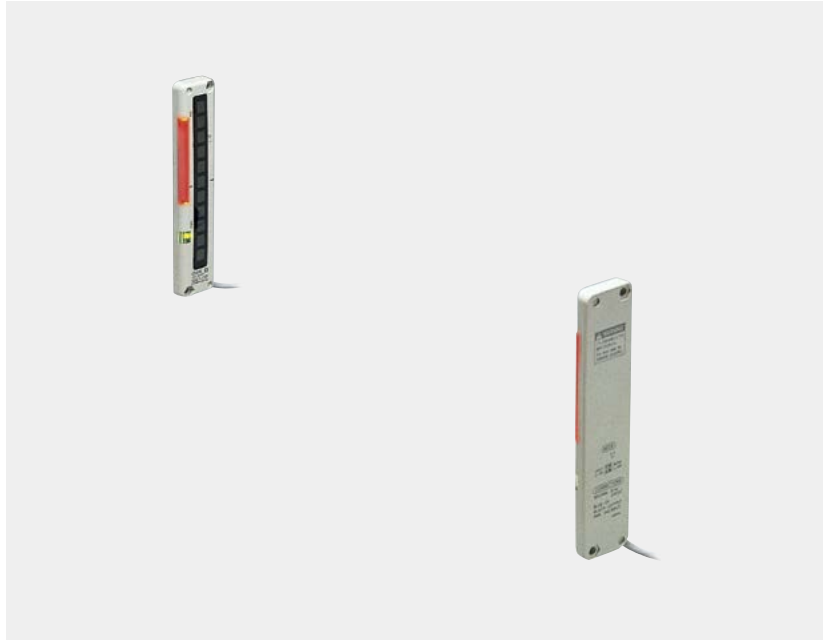

NA1-11

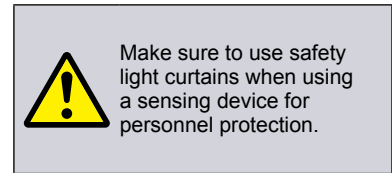

Cross-beam scanning system to detect slim objects

Letters or business cards detectable!

Slim objects can be detected by the cross-beam scanning system.

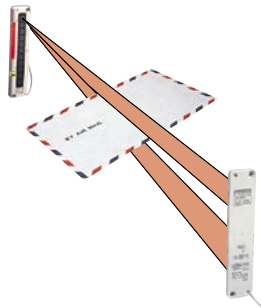

Emitting and receiving element pitch: 10 mm 0.394 in

A minimum sensing object size of $\varnothing 13.5$ mm $\varnothing 0.531$ in can be detected by an emitting and receiving element pitch of 10 mm 0.394 in.

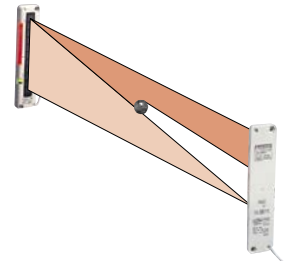

Wide area

Though being extremely slim, it has a wide sensing area of 1 m 3.281 ft length and 100 mm 3.937 in width. It is most suitable for object detection on a wide assembly line, or for detecting the dropping or incursion of small objects whose travel path is uncertain.

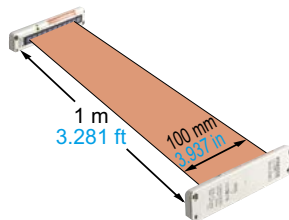

Just 10 mm 0.394 in thick

It is extremely slim, being just 10 mm 0.394 in thick. Further, it can be mounted in a narrow space as you can select from two cable orientation directions.



It is possible to select from two cable orientation directions.

Globally usable

It conforms to the EMC Directive and the UL Recognition. Moreover, PNP output type, which is much in demand in Europe, is also available.

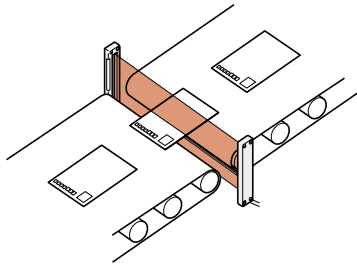
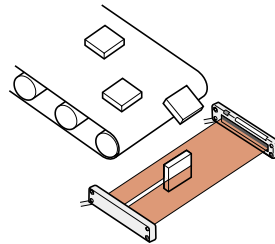
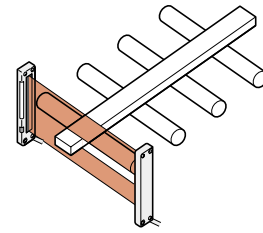
APPLICATIONS**Detecting post-cards****Detecting falling objects whose path is uncertain****Detecting the edges of moving objects**

WARNING Never use this product in any personnel safety application.

No synchronization wire

Wiring is saved and made simple as no synchronization wire is required between the emitter and the receiver.

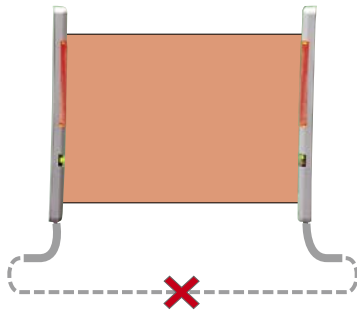
**Clearly visible large indicator**

A clearly visible large indicator, having a 55 mm 2.165 in width, is incorporated on both the emitter and the receiver. Further, if the sensing output is directly connected to the large indicator input, the indicator can be conveniently used as a large operation indicator. Moreover, its operation is selectable between lighting or blinking.

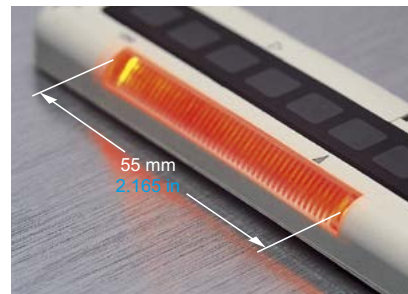
**Cross-beam Scanning System**

In a conventional area sensor, slim objects cannot be detected since the emitting and the receiving elements are scanned synchronously as a set. In contrast, in **NA1-11**, only the elements ① to ⑩ of the emitter are scanned to obtain emission. The elements of the receiver are not scanned, so that when element ① of the emitter emits light, all the elements of the receiver receive light. Hence, even if there is one element on the receiver which does not receive light, it results in light interrupted operation. With this technique, detection of slim objects is possible.

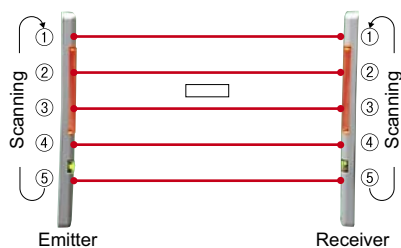
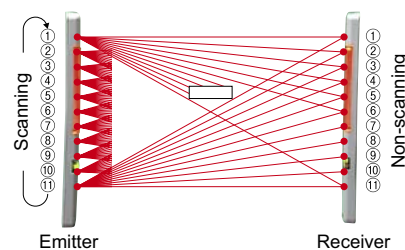
Conventional area sensor**NA1-11**

ORDER GUIDE

Type	Appearance	Sensing range (Note1)	Model No.(Note2)	Output
NPN output	<p>Sensing height: 100 mm 3.937 in</p> <p>No. of elements per emitter / receiver: 11</p> <p>Element pitch: 10 mm 0.394 in</p>	<p>0.17 to 1 m 0.558 to 3.281 ft</p>	NA1-11	NPN open-collector transistor
5 m 16.404 ft cable length			NA1-11-C5	
PNP output			NA1-11-PN	PNP open-collector transistor

Notes: 1) The sensing range is the possible setting distance between the emitter and the receiver.

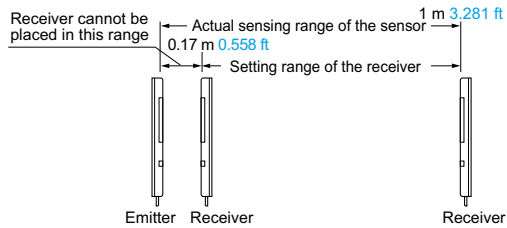

2) The model No. with suffix "P" shown on the label affixed to the product is the emitter, "D" shown on the label is the receiver.

OPTIONS

Designation	Model No.	Description
Sensor mounting bracket	MS-NA1-1	Four bracket set Four M4 (length 15 mm 0.591 in) screws with washers, eight nuts, four hooks, four spacers and eight M4 (length 18 mm 0.709 in) screws with washers are attached. (Spacers are not attached with MS-NA1-1 .)
	MS-NA2-1	

Sensor mounting bracket

• MS-NA1-1

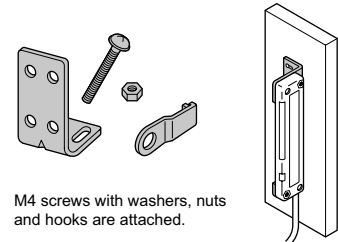

• MS-NA2-1

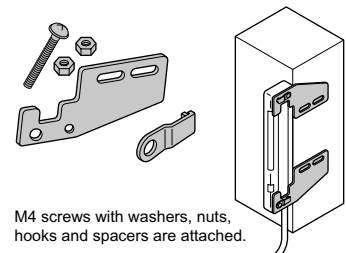

SPECIFICATIONS

Type	NPN output	PNP output	
Item	Model No.	Model No.	
CE marking directive compliance	EMC Directive, RoHS Directive		
Sensing height	100 mm 3.937 in		
Sensing range (Note 2)	0.17 to 1 m 0.558 to 3.281 ft		
Element pitch	10 mm 0.394 in		
Number of emitting/receiving elements	11 Nos. each on the emitter and the receiver, respectively		
Sensing object	ø13.5 mm ø0.531 in or more opaque object (Note 3)		
Supply voltage	12 to 24 V DC ±10 % Ripple P-P 10 % or less		
Current consumption	Emitter: 80 mA or less, Receiver: 100 mA or less		
Output	NPN open-collector transistor <ul style="list-style-type: none"> • Maximum sink current: 100 mA • Applied voltage: 30 V DC or less (between output and 0 V) • Residual voltage: 1 V or less (at 100 mA sink current) 0.4 V or less (at 16 mA sink current) 	PNP open-collector transistor <ul style="list-style-type: none"> • Maximum source current: 100 mA • Applied voltage: 30 V DC or less (between output and +V) • Residual voltage: 1 V or less (at 100 mA source current) 0.4 V or less (at 16 mA source current) 	
	Utilization category	DC-12 or DC-13	
	Output operation	ON or OFF when beam channel is interrupted, selectable by operation mode switch	
	Short-circuit protection	Incorporated	
Response time	In Dark state: 5 ms or less, In Light state: 10 ms or less		
Indicators	Emitter	Power indicator: Green LED (lights up when the power is ON) Large indicator: Orange LED (lights up or blinks when the large indicator input is Low, lighting pattern is selected by operation mode switch)	Power indicator: Green LED (lights up when the power is ON) Large indicator: Orange LED (lights up or blinks when the large indicator input is High, lighting pattern is selected by operation mode switch)
	Receiver	Operation indicator: Orange LED (lights up when the output is ON) Power indicator: Green LED (lights up when the power is ON) Large indicator: Orange LED (lights up or blinks when the large indicator input is Low, lighting pattern is selected by operation mode switch)	Operation indicator: Orange LED (lights up when the output is ON) Power indicator: Green LED (lights up when the power is ON) Large indicator: Orange LED (lights up or blinks when the large indicator input is High, lighting pattern is selected by operation mode switch)
Environmental resistance	Pollution degree	3 (Industrial environment)	
	Protection	IP62 (IEC)	
	Ambient temperature	-10 to 55 °C +14 to +131 °F (No dew condensation or icing allowed), Storage: -20 to +70 °C -4 to +158 °F	
	Ambient humidity	35 to 85 % RH, Storage: 35 to 85 % RH	
	Ambient illuminance	Incandescent light: 3,000 lx or less at the light-receiving face	
	Voltage withstandability	1,000 V AC for one min. between all supply terminals connected together and enclosure	
	Insulation resistance	20 MΩ, or more, with 250 V DC megger between all supply terminals connected together and enclosure	
	Vibration resistance	10 to 150 Hz frequency, 1.5 mm 0.059 in double amplitude in X, Y and Z directions for two hours each	
	Shock resistance	500 m/s ² acceleration (50 G approx.) in X, Y and Z directions three times each	
Emitting element	Infrared LED (Peak emission wavelength: 880nm 0.035mil , cross-beam scanning system)		
Material	Enclosure: Heat-resistant ABS, Lens: Acrylic, Indicator cover: Acrylic		
Cable	0.3 mm ² 4-core (emitter: 3-core) oil resistant cabtyre cable, 2 m 6.562 ft long		
Cable extension	Extension up to total 100 m 328.084 ft is possible, for both emitter and receiver, with 0.3 mm ² , or more, cable.		
Weight	Net weight: Emitter 80 g approx., Receiver 85 g approx, Gross Weight: 210 g approx.		

Notes: 1) Where measurement conditions have not been specified precisely, the conditions used were an ambient temperature of +23 °C **+73.4 °F**.

2) The sensing range is the possible setting distance between the emitter and the receiver.

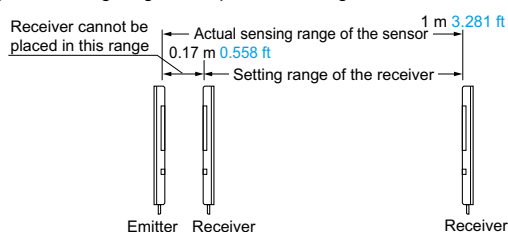

3) Although this product can detect slim objects by using the cross-beam scanning system, the size of the slim object which can be stably detected differs with the setting distance. When this sensor is used to detect slim objects, make sure to confirm stable detection using the actual objects.

I/O CIRCUIT AND WIRING DIAGRAMS

NA1-11

NPN output type

I/O circuit diagram

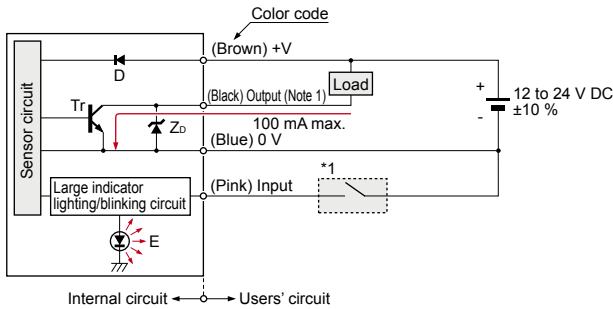

- Notes: 1) The emitter does not incorporate the output (black).
 2) Unused wires must be insulated to ensure that they do not come into contact with wires already in use.

Symbols ... D : Reverse supply polarity protection diode
 Zd: Surge absorption zener diode
 Tr : NPN output transistor
 E : Large indicator (INDICATOR)

Wiring diagram

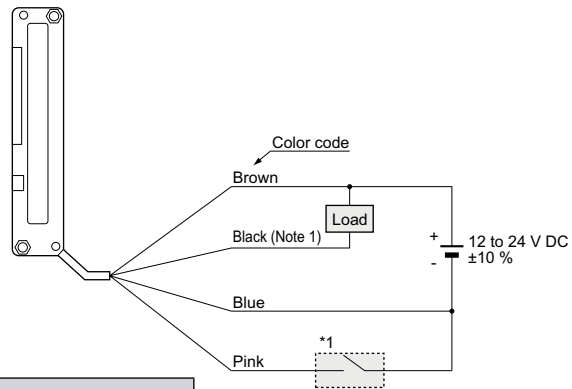

- Notes: 1) The emitter does not incorporate the black lead wire.
 2) Unused wires must be insulated to ensure that they do not come into contact with wires already in use.

* 1

Non-voltage contact or NPN open-collector transistor

- Input
- Low (0 to 2 V): Lights up or blinks
- High (5 to 30 V, or open): Lights off

NA1-11-PN

PNP output type

I/O circuit diagram

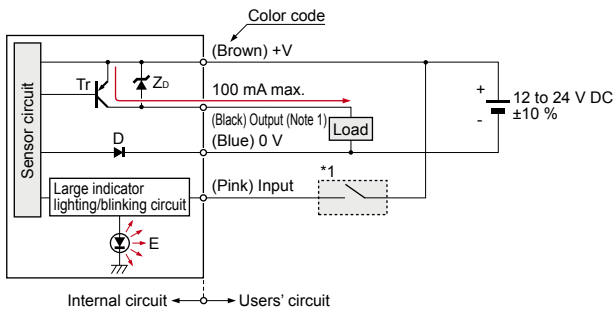

- Notes: 1) The emitter does not incorporate the output (black).
 2) Unused wires must be insulated to ensure that they do not come into contact with wires already in use.

Symbols ... D : Reverse supply polarity protection diode
 Zd: Surge absorption zener diode
 Tr : PNP output transistor
 E : Large indicator (INDICATOR)

Wiring diagram

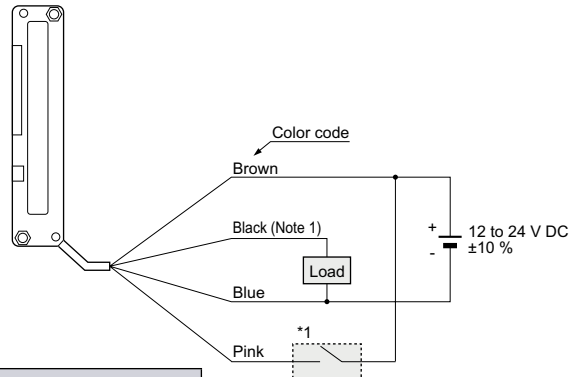

- Notes: 1) The emitter does not incorporate the black lead wire.
 2) Unused wires must be insulated to ensure that they do not come into contact with wires already in use.

* 1

Non-voltage contact or PNP open-collector transistor

- Input
- Low (4 V or more): Lights up or blinks
- High (0 to 0.6 V, or open): Lights off

SENSING CHARACTERISTICS (TYPICAL)

Correlation between setting distance and excess gain

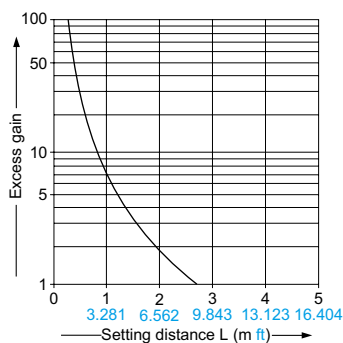

SENSING CHARACTERISTICS (TYPICAL)

Parallel deviation

Vertical direction

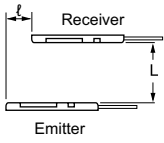

Horizontal direction

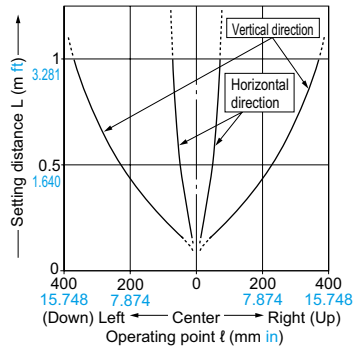
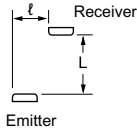

Angular deviation

Emitter angular deviation

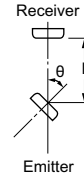

Receiver angular deviation

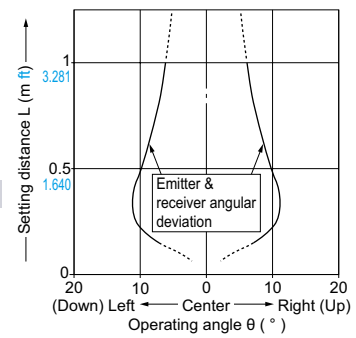
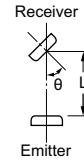

Correlation between setting distance and minimum length of detectable object

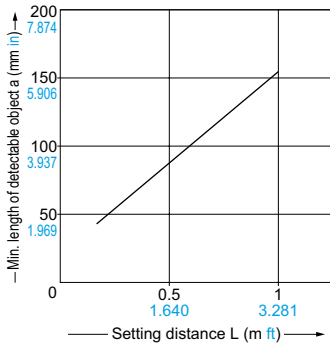

The minimum length of the detectable object, which lies in a plane perpendicular to the sensor front surface, varies with the setting distance, as shown in the left graph. However, note that the minimum length of the detectable object also varies with the object thickness.

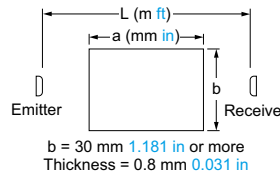

* The sensing object is considered to be placed at the center of the sensing area.

PRECAUTIONS FOR PROPER USE



- Never use this product as a sensing device for personnel protection.
- For sensing devices to be used as safety devices for press machines or for personnel protection, use products which meet laws and standards, such as OSHA, ANSI or IEC etc., for personnel protection applicable in each region or country.
- If this product is used as a sensing device for personnel protection, death or serious body injury could result.
- For a product which meets safety standards, use the safety light curtain.

Mounting

- Use M4 screws with washers and M4 nuts. The tightening torque should be 0.5 N·m or less. (Purchase the screws and nuts separately.)

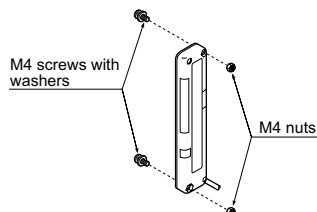

Selection of large indicator operation

- Lighting/Blinking is selected by the operation mode switch on the emitter and the receiver.

Operation of large indicator	Operation mode switch	
	Emitter	Receiver
Lighting	LIGHT <input type="checkbox"/> BLINK <input type="checkbox"/>	LIGHT <input type="checkbox"/> BLINK <input type="checkbox"/>
Blinking	LIGHT <input type="checkbox"/> BLINK <input type="checkbox"/>	LIGHT <input type="checkbox"/> BLINK <input type="checkbox"/>

Selection of output operation

- The output operation mode is selected by the operation mode switch on the receiver.

(The switches must be set with the power supply off. The operation mode does not change if the switch setting is changed with the power supplied.)

Operation mode switch (Receiver)	Output operation	Operation indicator (Orange)
D-ON <input type="checkbox"/> L-ON <input type="checkbox"/>	ON in Dark state	Lights up when the output is ON
L-ON <input type="checkbox"/> D-ON <input type="checkbox"/>	OFF in Dark state	Lights up when the output is ON

Note: LIGHT/BLINK switch is not related to the output operation selection.

PRECAUTIONS FOR PROPER USE

Wiring

- Make sure that the power supply is off while wiring.
- Verify that the supply voltage variation is within the rating.
- If power is supplied from a commercial switching regulator, ensure that the frame ground (F.G.) terminal of the power supply is connected to an actual ground.
- Ensure that an isolation transformer is utilized for the DC power supply. If an autotransformer is utilized, the main body or power supply may be damaged.
- If the used power supply generates a surge, connect a surge absorber to the power supply to absorb the surge.
- In case noise generating equipment (switching regulator, inverter motor, etc.) is used in the vicinity of this product, connect the frame ground (F.G.) terminal of the equipment to an actual ground.
- Do not run the wires together with high-voltage lines or power lines or put them in the same raceway. This can cause malfunction due to induction.
- Make sure that stress by forcible bend or pulling is not applied directly to the sensor cable joint.

Others

- Do not use during the initial transient time (0.5 sec.) after the power supply is switched on.
- Although this sensor can detect slim objects by using the cross-beam scanning system, the size of the slim object which can be stably detected differs with the setting distance. Hence, when the sensor is used to detect slim objects, make sure to confirm stable detection using the actual objects.
- In case of this sensor, light from the emitter spreads above and below the sensor. Hence, take care that if there is a reflective object above or below the sensor it will affect the sensing.

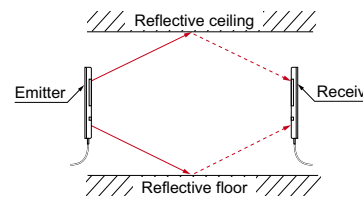

* Refer to "Parallel deviation" (p.7).

DIMENSIONS (Unit: mm in)

The CAD data can be downloaded from our website.

NA1-11 NA1-11-PN

Sensor

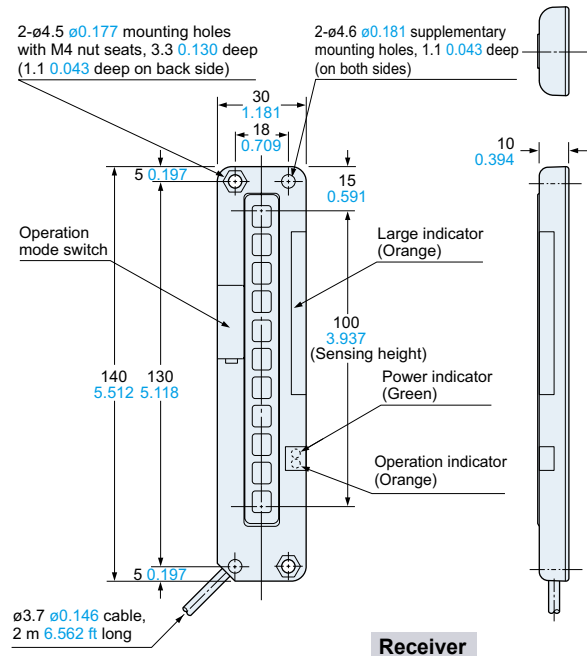
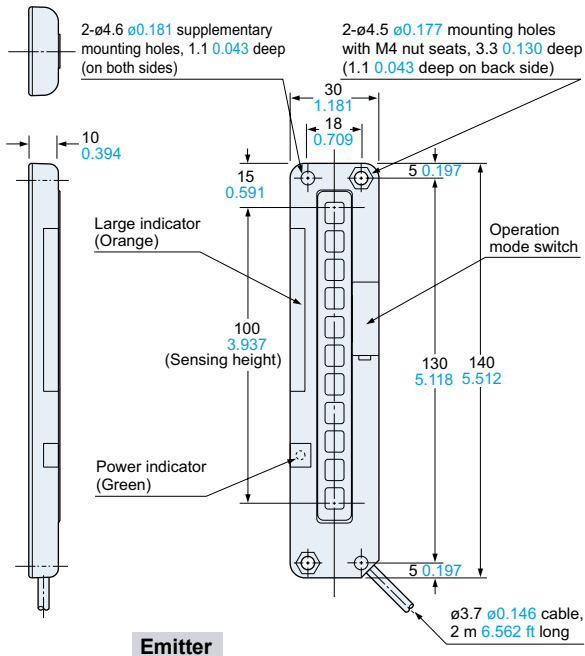

Disclaimer

The applications described in the catalog are all intended for examples only. The purchase of our products described in the catalog shall not be regarded as granting of a license to use our products in the described applications. We do NOT warrant that we have obtained some intellectual properties, such as patent rights, with respect to such applications, or that the described applications may not infringe any intellectual property rights, such as patent rights, of a third party.

Panasonic
INDUSTRY

Panasonic Industry Co., Ltd.

Industrial Device Business Division

7-1-1, Morofuku, Daito-shi, Osaka 574-0044, Japan

industrial.panasonic.com/ac/e/