

300 mA 36 V Input Regulator for Automotive Applications

NO. EC-300-221111

OUTLINE

The R1511x is a CMOS-based high-voltage resistant and fast response voltage regulator that provides the minimum 300mA of output current. Internally, R1511x consists of an Output Short-circuit Protection Circuit, an Over-current Protection Circuit, and a Thermal Shutdown Circuit in addition to the basic regulator circuits. The operating temperature range is between -40°C to 125°C , and the maximum input voltage is 36V. All these features allow the R1511x to become an ideal power source for car accessories and ECUs.

R1511x is available in R1511xxxxB with the fixed output voltage type, and R1511x001C with adjustable output voltage type with external resistors. The output voltage accuracy is $\pm 1.0\%$.

R1511x is available in two types of packages for ultra high wattage: HSOP-6J and TO-252-5-P2.

FEATURES

- Input Voltage Range (Maximum Rating) 3.5V to 36V (50 V)
- Supply Current Typ. 100 μA
- Standby Current Typ. 0.1 μA (R1511xxxxB)
- Output Voltage Range R1511xxxxB: 3.0 V to 9.0 V (0.1 V step)
R1511x001C: 3.0V to 12.0V (Adjustable with external resistor)
- Output Voltage Accuracy R1511xxxxB: $\pm 1.0\%$ ($T_a=25^{\circ}\text{C}$)
- Feedback Voltage R1511x001C: 3.0V $\pm 1.0\%$ ($T_a=25^{\circ}\text{C}$)
- Output Voltage Temperature-Drift Coefficient Typ. $\pm 60\text{ppm}/^{\circ}\text{C}$
- Line Regulation Typ. 0.01%/V ($V_{\text{DD}}=V_{\text{OUT}}+0.5\text{V}$ to 36V)
- Dropout Voltage Typ. 0.64V ($I_{\text{OUT}}=300\text{mA}$, $V_{\text{OUT}}=5.0\text{V}$)
- Package Option HSOP-6J, TO-252-5-P2
- Built-in Output Short-circuit Protection Circuit Typ. 50mA
- Built-in Over-current Protection Circuit Typ. 450mA
- Built-in Thermal Shutdown Circuit Thermal Shutdown Temperature: Typ. 160°C
- Operating Temperature Range -40 to 125°C
- Ripple Rejection Typ. 65dB (1kHz)
- Ceramic capacitors are recommended to be used with this IC
..... $C_{\text{IN}}=1.0\mu\text{F}$ or more, $C_{\text{OUT}}=6.8\mu\text{F}$ or more

APPLICATIONS

- Power source for accessories such as car audios, car navigation systems, and ETC systems
- Power source for ECUs such as EV inverter and battery charge control unit

BLOCK DIAGRAMS

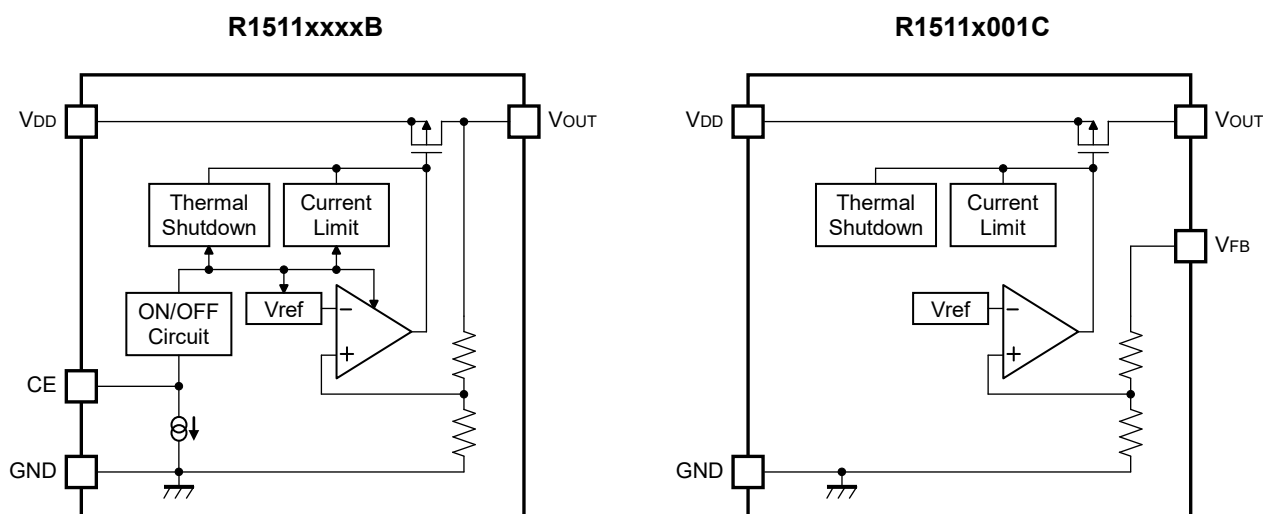

SELECTION GUIDE

The output voltage, version and the package type for the ICs can be selected at the user's request.

Product Name	Package	Quantity per Reel	Pb Free	Halogen Free
R1511Sxxx*-E2-#E	HSOP-6J	1,000 pcs	Yes	Yes
R1511Jxxx*-T1-#E	TO-252-5-P2	3,000 pcs	Yes	Yes

xxx : Specify the set output voltage (V_{SET})
 R1511xxxxB: 3.0 V (030) to 9.0 V (090) in 0.1 V step
 R1511x001C: Only (001)

* : Specify the version
 (B): Fixed output and Built-in Chip Enable (Active-high)
 (C): Adjustable output

: Specify Automotive Class Code

	Operating Temperature Range	Guaranteed Specs Temperature Range	Screening
A	-40°C to 125°C	25°C	High Temperature
K	-40°C to 125°C	-40°C to 125°C	High and Low Temperature

PIN DESCRIPTIONS

● HSOP-6J

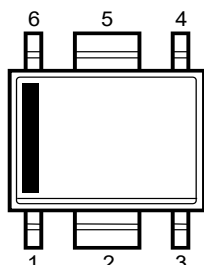

● TO-252-5-P2

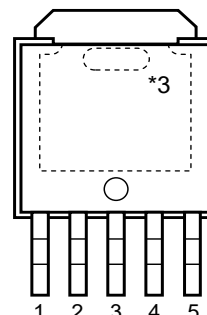

HSOP-6J

Pin No.	Symbol	Description	
1	V_{DD}	Input Pin	
2	GND ^{*1}	Ground Pin	
3	GND ^{*1}	Ground Pin	
4	CE	R1511SxxxB	Chip Enable Pin (Active-high)
	V_{FB}	R1511S001C	Feed Back Pin
5	GND ^{*1}	Ground Pin	
6	V_{OUT}	Output Pin	

^{*1} The GND pin must be wired together when it is mounted on board.

TO-252-5-P2

Pin No.	Symbol	Description	
1	V_{DD}	Input Pin	
2	GND ^{*2}	Ground Pin	
3	GND ^{*2}	Ground Pin	
4	CE	R1511JxxxB	Chip Enable Pin (Active-high)
	V_{FB}	R1511J001C	Feed Back Pin
5	V_{OUT}	Output Pin	

^{*2} The GND pin must be wired together when it is mounted on board.

^{*3} The tab on the bottom of the package enhances thermal performance and is electrically connected to GND (substrate level). It is recommended that the tab be connected to the ground plane on the board, or otherwise be left open.

ABSOLUTE MAXIMUM RATINGS

Symbol	Item	Rating		Unit
V _{IN}	Input Voltage	-0.3 to 50		V
V _{IN}	Peak Input Voltage* ¹	60		V
V _{CE}	Input Voltage (CE Pin)	-0.3 to 50		V
V _{FB}	Input Voltage (V _{FB} Pin)	-0.3 to 50		V
V _{OUT}	Output Voltage	-0.3 to V _{IN} +0.3 ≤ 50		V
I _{OUT}	Output Current	450		mA
P _D	Power Dissipation (HSOP-6J)* ²	JEDEC STD. 51-7	3400	mW
	Power Dissipation (TO-252-5-P2)* ²	JEDEC STD. 51-7	4800	
T _j	Operating Junction Temperature Range	-40 to 150		°C
T _{stg}	Storage Temperature Range	-55 to 150		°C

*¹ Duration time: 200ms

*² Refer to *PACKAGE INFORMATION* for detailed information.

ABSOLUTE MAXIMUM RATINGS

Electronic and mechanical stress momentarily exceeded absolute maximum ratings may cause the permanent damages and may degrade the lifetime and safety for both device and system using the device in the field. The functional operation at or over these absolute maximum ratings are not assured.

RECOMMENDED OPERATING CONDITIONS

Symbol	Item	Rating	Unit
V _{IN}	Input Voltage	3.5 to 36	V
T _a	Operating Temperature Range	-40 to 125	°C

RECOMMENDED OPERATING CONDITIONS

All of electronic equipment should be designed that the mounted semiconductor devices operate within the recommended operating conditions. The semiconductor devices cannot operate normally over the recommended operating conditions, even if when they are used over such conditions by momentary electronic noise or surge. And the semiconductor devices may receive serious damage when they continue to operate over the recommended operating conditions.

ELECTRICAL CHARACTERISTICS

$C_{IN}=1.0\mu F$, $C_{OUT}=6.8\mu F$, unless otherwise noted.

The specifications surrounded by are guaranteed by design engineering at $-40^{\circ}C \leq T_a \leq 125^{\circ}C$.

R1511xxxxB-AE

($T_a=25^{\circ}C$)

Symbol	Item	Conditions	Min.	Typ.	Max.	Unit
I_{SS}	Supply Current	$V_{IN}=V_{SET}+1.0V$, $I_{OUT}=0mA$		100	<input type="checkbox"/> 180	μA
$I_{standby}$	Standby Current	$V_{IN}=36V$, $V_{CE}=0V$		0.1	<input type="checkbox"/> 2.0	μA
V_{OUT}	Output Voltage	$V_{IN}=V_{SET}+2.0V$ $I_{OUT}=1mA$	$T_a=25^{\circ}C$	$\times 0.99$	$\times 1.01$	V
			$-40^{\circ}C \leq T_a \leq 125^{\circ}C$	<input type="checkbox"/> $\times 0.98$	<input type="checkbox"/> $\times 1.02$	
$\frac{\Delta V_{OUT}}{\Delta I_{OUT}}$	Load Regulation	$V_{IN}=V_{SET}+2.0V$ $1mA \leq I_{OUT} \leq 300mA$	$V_{SET} \leq 5.0V$	<input type="checkbox"/> -20	<input type="checkbox"/> 100	mV
			$5.0V < V_{SET}$	<input type="checkbox"/> -20	<input type="checkbox"/> 120	
$\frac{\Delta V_{OUT}}{\Delta V_{IN}}$	Line Regulation	$V_{SET}+0.5V \leq V_{IN} \leq 36V$, $I_{OUT}=1mA$		0.01	<input type="checkbox"/> 0.02	%/V
V_{DIF}	Dropout Voltage	$I_{OUT}=300mA$	Refer to the <i>Product-specific Electrical Characteristics</i>			
I_{LIM}	Output Current Limit	$V_{IN}=V_{SET}+2.5V$		450		mA
I_{SC}	Short Current Limit	$V_{OUT}=0V$		50		mA
V_{CEH}	CE Input Voltage "H"		<input type="checkbox"/> 2.2		36	V
V_{CEL}	CE Input Voltage "L"		0		<input type="checkbox"/> 1.0	V
I_{PD}	CE Pull-down Current	$V_{CE}=5.0V$		0.2	<input type="checkbox"/> 0.6	μA
		$V_{CE}=36V$		0.5	<input type="checkbox"/> 1.3	
T_{TSD}	Thermal Shutdown Temperature	Junction Temperature		160		$^{\circ}C$
T_{TSR}	Thermal Shutdown Released Temperature	Junction Temperature		135		$^{\circ}C$

All test items listed under Electrical Characteristics are done under the pulse load condition ($T_j \approx T_a = 25^{\circ}C$).

Product-specific Electrical Characteristics

The specifications surrounded by are guaranteed by design engineering at $-40^{\circ}\text{C} \leq T_a \leq 125^{\circ}\text{C}$.

Product Name	V_{OUT} [V]					V_{DIF} [V]	
	(Ta = 25°C)			(Ta = -40°C to 125°C)		TYP.	MAX.
	MIN.	TYP.	MAX.	MIN.	MAX.		
R1511x030x	2.970	3.000	3.030	2.940	3.060	0.98	1.50
R1511x031x	3.069	3.100	3.131	3.038	3.162		
R1511x032x	3.168	3.200	3.232	3.136	3.264	0.94	1.40
R1511x033x	3.267	3.300	3.333	3.234	3.366		
R1511x034x	3.366	3.400	3.434	3.332	3.468		
R1511x035x	3.465	3.500	3.535	3.430	3.570	0.88	1.30
R1511x036x	3.564	3.600	3.636	3.528	3.672		
R1511x037x	3.663	3.700	3.737	3.626	3.774		
R1511x038x	3.762	3.800	3.838	3.724	3.876		
R1511x039x	3.861	3.900	3.939	3.822	3.978	0.79	1.20
R1511x040x	3.960	4.000	4.040	3.920	4.080		
R1511x041x	4.059	4.100	4.141	4.018	4.182		
R1511x042x	4.158	4.200	4.242	4.116	4.284		
R1511x043x	4.257	4.300	4.343	4.214	4.386		
R1511x044x	4.356	4.400	4.444	4.312	4.488	0.71	1.10
R1511x045x	4.455	4.500	4.545	4.410	4.590		
R1511x046x	4.554	4.600	4.646	4.508	4.692		
R1511x047x	4.653	4.700	4.747	4.606	4.794		
R1511x048x	4.752	4.800	4.848	4.704	4.896		
R1511x049x	4.851	4.900	4.949	4.802	4.998	0.64	1.00
R1511x050x	4.950	5.000	5.050	4.900	5.100		
R1511x051x	5.049	5.100	5.151	4.998	5.202		
R1511x052x	5.148	5.200	5.252	5.096	5.304		
R1511x053x	5.247	5.300	5.353	5.194	5.406		
R1511x054x	5.346	5.400	5.454	5.292	5.508		
R1511x055x	5.445	5.500	5.555	5.390	5.610	0.59	0.90
R1511x056x	5.544	5.600	5.656	5.488	5.712		
R1511x057x	5.643	5.700	5.757	5.586	5.814		
R1511x058x	5.742	5.800	5.858	5.684	5.916		
R1511x059x	5.841	5.900	5.959	5.782	6.018		

R1511xxxxB-AE

(Ta=25°C)

Product Name	V _{OUT} [V]					V _{DIF} [V]	
	(Ta = 25°C)			(Ta = -40°C to 125°C)		TYP.	MAX.
	MIN.	TYP.	MAX.	MIN.	MAX.		
R1511x060x	5.940	6.000	6.060	5.880	6.120	0.59	0.90
R1511x061x	6.039	6.100	6.161	5.978	6.222		
R1511x062x	6.138	6.200	6.262	6.076	6.324		
R1511x063x	6.237	6.300	6.363	6.174	6.426		
R1511x064x	6.336	6.400	6.464	6.272	6.528		
R1511x065x	6.435	6.500	6.565	6.370	6.630		
R1511x066x	6.534	6.600	6.666	6.468	6.732		
R1511x067x	6.633	6.700	6.767	6.566	6.834		
R1511x068x	6.732	6.800	6.868	6.664	6.936		
R1511x069x	6.831	6.900	6.969	6.762	7.038		
R1511x070x	6.930	7.000	7.070	6.860	7.140	0.54	0.80
R1511x071x	7.029	7.100	7.171	6.958	7.242		
R1511x072x	7.128	7.200	7.272	7.056	7.344		
R1511x073x	7.227	7.300	7.373	7.154	7.446		
R1511x074x	7.326	7.400	7.474	7.252	7.548		
R1511x075x	7.425	7.500	7.575	7.350	7.650		
R1511x076x	7.524	7.600	7.676	7.448	7.752		
R1511x077x	7.623	7.700	7.777	7.546	7.854		
R1511x078x	7.722	7.800	7.878	7.644	7.956		
R1511x079x	7.821	7.900	7.979	7.742	8.058		
R1511x080x	7.920	8.000	8.080	7.840	8.160	0.47	0.70
R1511x081x	8.019	8.100	8.181	7.938	8.262		
R1511x082x	8.118	8.200	8.282	8.036	8.364		
R1511x083x	8.217	8.300	8.383	8.134	8.466		
R1511x084x	8.316	8.400	8.484	8.232	8.568		
R1511x085x	8.415	8.500	8.585	8.330	8.670		
R1511x086x	8.514	8.600	8.686	8.428	8.772		
R1511x087x	8.613	8.700	8.787	8.526	8.874		
R1511x088x	8.712	8.800	8.888	8.624	8.976		
R1511x089x	8.811	8.900	8.989	8.722	9.078		
R1511x090x	8.910	9.000	9.090	8.820	9.180		

$V_{OUT}=V_{FB}$, $C_{IN}=1.0\mu F$, $C_{OUT}=6.8\mu F$, unless otherwise noted.

The specifications surrounded by are guaranteed by design engineering at $-40^{\circ}C \leq T_a \leq 125^{\circ}C$.

R1511x001C-AE

(Ta=25°C)

Symbol	Item	Conditions	Min.	Typ.	Max.	Unit
I _{SS}	Supply Current	V _{IN} =4.0V, I _{OUT} =0mA		100	<input type="checkbox"/> 180	μA
V _{OUT}	Output Voltage	V _{IN} =5.0V I _{OUT} =1mA	T _a =25°C	2.97	3.03	V
			-40°C≤T _a ≤125°C	<input type="checkbox"/> 2.94	<input type="checkbox"/> 3.06	
$\frac{\Delta V_{OUT}}{\Delta I_{OUT}}$	Load Regulation	V _{IN} =5.0V 1mA≤I _{OUT} ≤300mA	<input type="checkbox"/> -20		<input type="checkbox"/> 40	mV
$\frac{\Delta V_{OUT}}{\Delta V_{IN}}$	Line Regulation	V _{SET} +0.5V≤V _{IN} ≤36V I _{OUT} =1mA		0.01	<input type="checkbox"/> 0.02	%/V
V _{DIF}	Dropout Voltage	I _{OUT} =300mA		0.98	<input type="checkbox"/> 1.5	V
I _{LIM}	Output Current Limit	V _{IN} =V _{SET} +2.5V		450		mA
I _{SC}	Short Current Limit	V _{OUT} =0V		50		mA
R _{FB}	V _{FB} Pin Resistanse		<input type="checkbox"/> 1.0	3.0		MΩ
T _{TSD}	Thermal Shutdown Temperature	Junction Temperature		160		°C
T _{TSR}	Thermal Shutdown Released Temperature	Junction Temperature		135		°C

All test items listed under Electrical Characteristics are done under the pulse load condition (T_j≈T_a=25°C).

$C_{IN}=1.0\mu F$, $C_{OUT}=6.8\mu F$, unless otherwise noted.

R1511xxxxB-KE

($-40^{\circ}C \leq T_a \leq 125^{\circ}C$)

Symbol	Item	Conditions	Min.	Typ.	Max.	Unit
I_{SS}	Supply Current	$V_{IN}=V_{SET}+1.0V$, $I_{OUT}=0mA$		100	180	μA
$I_{standby}$	Standby Current	$V_{IN}=36V$, $V_{CE}=0V$		0.1	2.0	μA
V_{OUT}	Output Voltage	$V_{IN}=V_{SET}+2.0V$ $I_{OUT}=1mA$	$T_a=25^{\circ}C$	$\times 0.99$	$\times 1.01$	V
			$-40^{\circ}C \leq T_a \leq 125^{\circ}C$	$\times 0.98$	$\times 1.02$	
$\frac{\Delta V_{OUT}}{\Delta I_{OUT}}$	Load Regulation	$V_{IN}=V_{SET}+2.0V$ $1mA \leq I_{OUT} \leq 300mA$	$V_{SET} \leq 5.0V$	-20	100	mV
			$5.0V < V_{SET}$	-20	120	
$\frac{\Delta V_{OUT}}{\Delta V_{IN}}$	Line Regulation	$V_{SET}+0.5V \leq V_{IN} \leq 36V$, $I_{OUT}=1mA$	-0.02	0.01	0.02	%/V
V_{DIF}	Dropout Voltage	$I_{OUT}=300mA$	Refer to the <i>Product-specific Electrical Characteristics</i>			
I_{LIM}	Output Current Limit	$V_{IN}=V_{SET}+2.5V$	300	450	610	mA
I_{SC}	Short Current Limit	$V_{IN}=5V$, $V_{OUT}=0V$	35	50	65	mA
V_{CEH}	CE Input Voltage "H"		2.2		36	V
V_{CEL}	CE Input Voltage "L"		0		1.0	V
I_{PD}	CE Pull-down Current	$V_{CE}=5.0V$		0.2	0.6	μA
		$V_{CE}=36V$		0.5	1.3	
T_{TSD}	Thermal Shutdown Temperature	Junction Temperature	150	160		$^{\circ}C$
T_{TSR}	Thermal Shutdown Released Temperature	Junction Temperature	125	135		$^{\circ}C$

Product-specific Electrical Characteristics

R1511xxxxB-KE (-40°C ≤ Ta ≤ 125°C)

Product Name	V _{OUT} [V]					V _{DIF} [V]	
	(Ta = 25°C)			(Ta = -40°C to 125°C)		TYP.	MAX.
	MIN.	TYP.	MAX.	MIN.	MAX.		
R1511x030x	2.970	3.000	3.030	2.940	3.060	0.98	1.50
R1511x031x	3.069	3.100	3.131	3.038	3.162		
R1511x032x	3.168	3.200	3.232	3.136	3.264	0.94	1.40
R1511x033x	3.267	3.300	3.333	3.234	3.366		
R1511x034x	3.366	3.400	3.434	3.332	3.468		
R1511x035x	3.465	3.500	3.535	3.430	3.570	0.88	1.30
R1511x036x	3.564	3.600	3.636	3.528	3.672		
R1511x037x	3.663	3.700	3.737	3.626	3.774		
R1511x038x	3.762	3.800	3.838	3.724	3.876		
R1511x039x	3.861	3.900	3.939	3.822	3.978	0.79	1.20
R1511x040x	3.960	4.000	4.040	3.920	4.080		
R1511x041x	4.059	4.100	4.141	4.018	4.182		
R1511x042x	4.158	4.200	4.242	4.116	4.284		
R1511x043x	4.257	4.300	4.343	4.214	4.386	0.71	1.10
R1511x044x	4.356	4.400	4.444	4.312	4.488		
R1511x045x	4.455	4.500	4.545	4.410	4.590		
R1511x046x	4.554	4.600	4.646	4.508	4.692		
R1511x047x	4.653	4.700	4.747	4.606	4.794		
R1511x048x	4.752	4.800	4.848	4.704	4.896		
R1511x049x	4.851	4.900	4.949	4.802	4.998	0.64	1.00
R1511x050x	4.950	5.000	5.050	4.900	5.100		
R1511x051x	5.049	5.100	5.151	4.998	5.202		
R1511x052x	5.148	5.200	5.252	5.096	5.304		
R1511x053x	5.247	5.300	5.353	5.194	5.406		
R1511x054x	5.346	5.400	5.454	5.292	5.508		
R1511x055x	5.445	5.500	5.555	5.390	5.610	0.59	0.90
R1511x056x	5.544	5.600	5.656	5.488	5.712		
R1511x057x	5.643	5.700	5.757	5.586	5.814		
R1511x058x	5.742	5.800	5.858	5.684	5.916		
R1511x059x	5.841	5.900	5.959	5.782	6.018		
R1511x060x	5.940	6.000	6.060	5.880	6.120		
R1511x061x	6.039	6.100	6.161	5.978	6.222	0.54	0.80
R1511x062x	6.138	6.200	6.262	6.076	6.324		
R1511x063x	6.237	6.300	6.363	6.174	6.426		
R1511x064x	6.336	6.400	6.464	6.272	6.528		
R1511x065x	6.435	6.500	6.565	6.370	6.630		
R1511x066x	6.534	6.600	6.666	6.468	6.732		
R1511x067x	6.633	6.700	6.767	6.566	6.834	0.54	0.80
R1511x068x	6.732	6.800	6.868	6.664	6.936		
R1511x069x	6.831	6.900	6.969	6.762	7.038		

R1511xxxB-KE (-40°C ≤ Ta ≤ 125°C)

Product Name	V _{OUT} [V]					V _{DIF} [V]	
	(Ta = 25°C)			(Ta = -40°C to 125°C)		TYP.	MAX.
	MIN.	TYP.	MAX.	MIN.	MAX.		
R1511x070x	6.930	7.000	7.070	6.860	7.140	0.54	0.80
R1511x071x	7.029	7.100	7.171	6.958	7.242		
R1511x072x	7.128	7.200	7.272	7.056	7.344		
R1511x073x	7.227	7.300	7.373	7.154	7.446		
R1511x074x	7.326	7.400	7.474	7.252	7.548		
R1511x075x	7.425	7.500	7.575	7.350	7.650		
R1511x076x	7.524	7.600	7.676	7.448	7.752		
R1511x077x	7.623	7.700	7.777	7.546	7.854		
R1511x078x	7.722	7.800	7.878	7.644	7.956		
R1511x079x	7.821	7.900	7.979	7.742	8.058		
R1511x080x	7.920	8.000	8.080	7.840	8.160		
R1511x081x	8.019	8.100	8.181	7.938	8.262		
R1511x082x	8.118	8.200	8.282	8.036	8.364		
R1511x083x	8.217	8.300	8.383	8.134	8.466		
R1511x084x	8.316	8.400	8.484	8.232	8.568		
R1511x085x	8.415	8.500	8.585	8.330	8.670		
R1511x086x	8.514	8.600	8.686	8.428	8.772		
R1511x087x	8.613	8.700	8.787	8.526	8.874		
R1511x088x	8.712	8.800	8.888	8.624	8.976		
R1511x089x	8.811	8.900	8.989	8.722	9.078		
R1511x090x	8.910	9.000	9.090	8.820	9.180		

$V_{OUT}=V_{FB}$, $C_{IN}=1.0\mu F$, $C_{OUT}=6.8\mu F$, unless otherwise noted.

R1511x001C-KE

(-40°C ≤ Ta ≤ 125°C)

Symbol	Item	Conditions	Min.	Typ.	Max.	Unit
I _{SS}	Supply Current	V _{IN} =4.0V, I _{OUT} =0mA		100	180	μA
V _{OUT}	Output Voltage	V _{IN} =5.0V I _{OUT} =1mA	T _a =25°C	2.97	3.03	V
			-40°C ≤ T _a ≤ 125°C	2.94	3.06	
$\frac{\Delta V_{OUT}}{\Delta I_{OUT}}$	Load Regulation	V _{IN} =5.0V 1mA ≤ I _{OUT} ≤ 300mA	-20		40	mV
$\frac{\Delta V_{OUT}}{\Delta V_{IN}}$	Line Regulation	V _{SET} +0.5V ≤ V _{IN} ≤ 36V I _{OUT} =1mA	-0.02	0.01	0.02	%/V
V _{DIF}	Dropout Voltage	I _{OUT} =300mA		0.98	1.5	V
I _{LIM}	Output Current Limit	V _{IN} = V _{SET} +2.5V	300	450	610	mA
I _{SC}	Short Current Limit	V _{IN} =5V, V _{OUT} =0V	35	50	65	mA
R _{FB}	V _{FB} Pin Resistanse		1.0	3.0		MΩ
T _{TSD}	Thermal Shutdown Temperature	Junction Temperature	150	160		°C
T _{TSR}	Thermal Shutdown Released Temperature	Junction Temperature	125	135		°C

TYPICAL APPLICATIONS

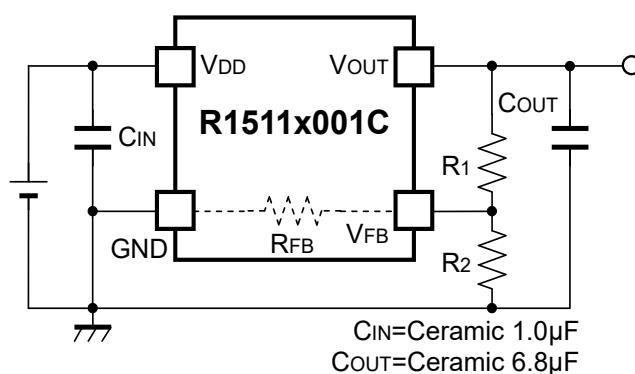
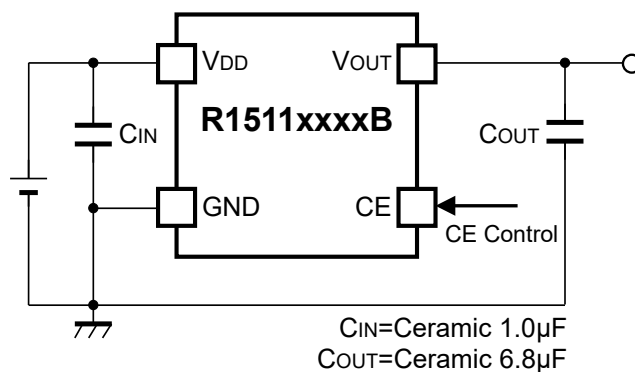

TECHNICAL NOTES

PCB Layout and GND Wiring

Ensure the V_{DD} and GND lines are sufficiently robust. If their impedance is too high, noise pickup or unstable operation may result. Connect a C_{IN} capacitor with 1.0 μ F or more value between the V_{DD} and GND pins, and as close as possible to the pins. Likewise, connect a C_{OUT} capacitor with suitable values between the V_{OUT} and GND pins, and as close as possible to the pins (refer to the Typical Application above).

In the case of using HSOP-6J package, make sure to wire No. 2, No. 3, and No. 5 pins to the GND plane. Also, in the case of using TO-252-5-P2 package, make sure to wire No. 2 and No. 3 pins to the GND plane.

Phase Compensation

In the R1511x, phase compensation is provided to secure stable operation even when the load current is varied. For this purpose, make sure to use a C_{OUT} capacitor.

In case of using a tantalum type capacitor and the ESR (Equivalent Series Resistance) value of the capacitor is large, the output might be unstable. Evaluate the circuit including consideration of frequency characteristics.

Depending on the capacitor size, manufacturer, and part number, the bias characteristics and temperature characteristics are different. Evaluate the circuit taking actual characteristics into account.

Thermal Shutdown

R1511x contains a thermal shutdown circuit, which stops regulator operation if the junction temperature of R1511x becomes higher than 160°C (Typ.). Additionally, if the junction temperature after the regulator being stopped decreases to a level below 135°C (Typ.), it restarts regulator operation. As a result the operation of the thermal shutdown circuit causes the regulator repeatedly to turn off and on until the causes of overheating are removed. As a consequence a pulse shaped output voltage occurs.

Adjustable Output Voltage Setting (R1511x001C)

The output voltage of R1511x001C can be adjusted by using the external divider resistors (R1, R2). By using the following equation, the output voltage (V_{OUT}) can be determined. The voltage which is fixed inside the IC is described as V_{FB} .

$$V_{OUT} = V_{FB} \times ((R1 + R2) / R2)$$

$$\text{Recommended Range: } 3.0 \text{ V} \leq V_{OUT} \leq 12.0 \text{ V}$$

$$V_{FB} = 3.0 \text{ V}$$

R_{FB} of the R1511x001C is approximately Min. 1.0 M Ω (guaranteed by design). For better accuracy, setting $R1 \ll R_{FB}$ reduces errors. The resistance value for R2 should be set to 39 k Ω or lower. It is easily affected by noises when setting the value of R1 and R2 larger, which makes the impedance of V_{FB} pin larger.

R_{IC} could be affected by the temperature, therefore evaluate the circuit taking the actual conditions of use into account when deciding the resistance values for R1 and R2.

TYPICAL APPLICATION FOR IC CHIP BREAKDOWN PREVENTION

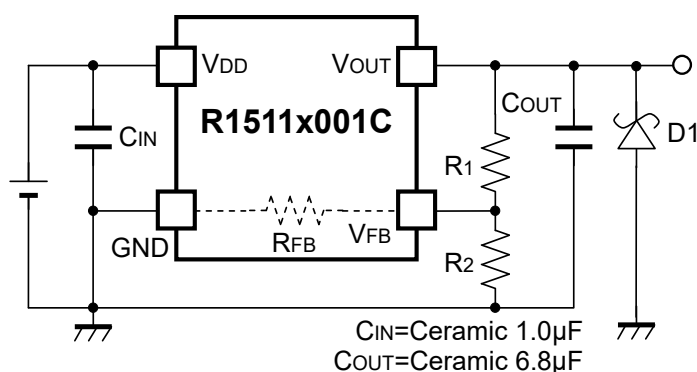
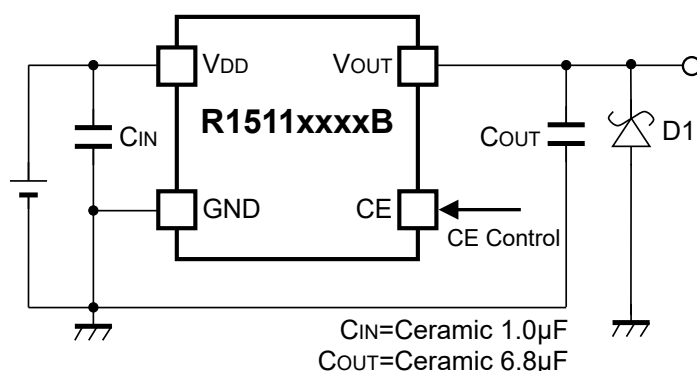

When a sudden surge of electrical current travels along the V_{OUT} pin and GND due to a short-circuit, electrical resonance of a circuit involving an output capacitor (C_{OUT}) and a short circuit inductor generates a negative voltage and may damage the device or the load devices. Connecting a schottky diode (D1) between the V_{OUT} pin and GND has the effect of preventing damage to them.

PIN EQUIVALENT CIRCUIT DIAGRAMS

<V_{OUT} Pin>

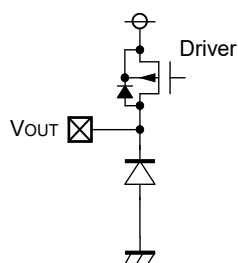

<CE Pin (R1511xxxxB)>

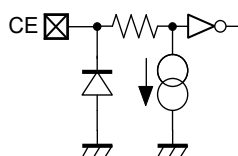

<V_{FB} Pin (R1511x001C)>

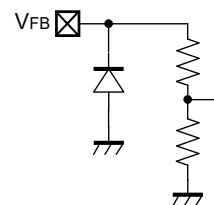

PACKAGE INFORMATION

POWER DISSIPATION (HSOP-6J)

The power dissipation of the package is dependent on PCB material, layout, and environmental conditions. The following measurement conditions are based on JEDEC STD. 51-7.

Measurement Conditions

Item	Measurement Conditions
Environment	Mounting on Board (Wind Velocity = 0 m/s)
Board Material	Glass Cloth Epoxy Plastic (Four-Layer Board)
Board Dimensions	76.2 mm × 114.3 mm × 0.8 mm
Copper Ratio	Outer Layer (First Layer): Less than 95% of 50 mm Square Inner Layers (Second and Third Layers): Approx. 100% of 50 mm Square Outer Layer (Fourth Layer): Approx. 100% of 50 mm Square
Through-holes	φ 0.3 mm × 28 pcs

Measurement Result (Ta = 25°C, Tjmax = 150°C)

Item	Measurement Result
Power Dissipation	3400 mW
Thermal Resistance (θ_{ja})	$\theta_{ja} = 37^{\circ}\text{C/W}$
Thermal Characterization Parameter (ψ_{jt})	$\psi_{jt} = 7^{\circ}\text{C/W}$

θ_{ja} : Junction-to-Ambient Thermal Resistance

ψ_{jt} : Junction-to-Top Thermal Characterization Parameter

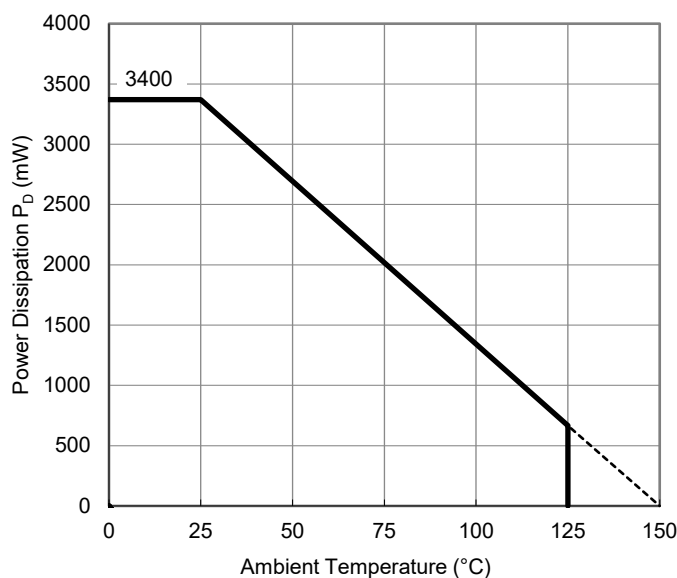

Power Dissipation vs. Ambient Temperature

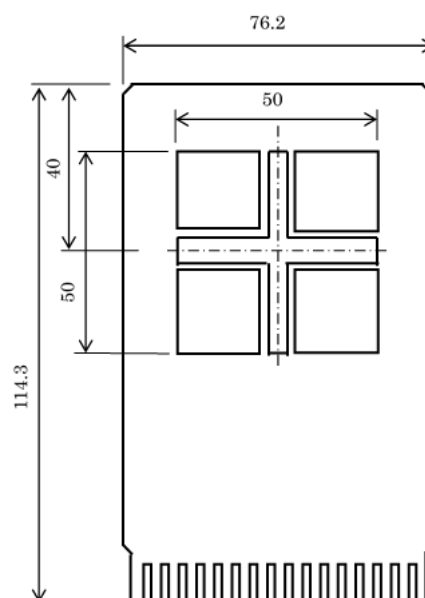

Measurement Board Pattern

PACKAGE DIMENSIONS (HSOP-6J)

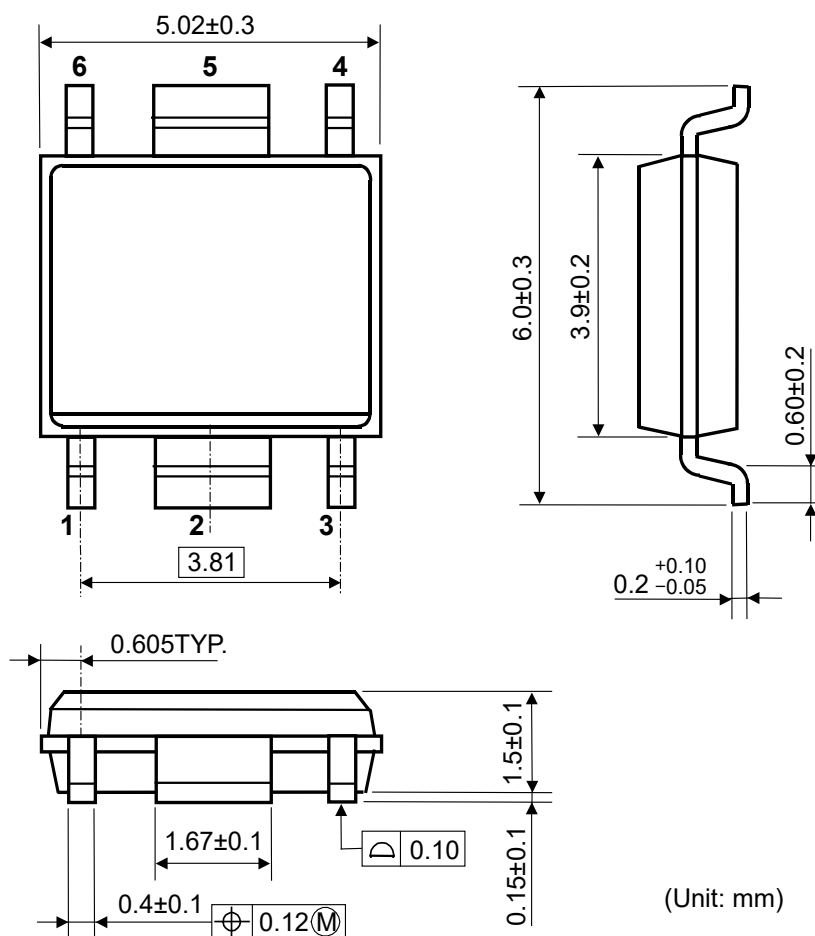

Package Dimensions (HSOP-6J)

MARK SPECIFICATION (HSOP-6J)

①②③④: Product Code ... **Refer to MARK SPECIFICATION TABLE**

⑤⑥: Lot Number ... Alphanumeric Serial Number

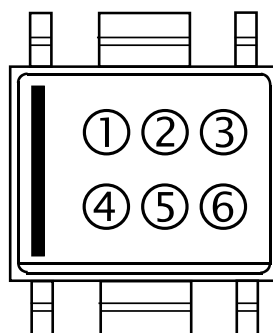

Mark Specification (HSOP-6J)

MARK SPECIFICATION TABLE (HSOP-6J)

R1511SxxxB

Product Name	① ② ③ ④	V _{SET}
R1511S030B	S 3 0 B	3.0 V
R1511S031B	S 3 1 B	3.1 V
R1511S032B	S 3 2 B	3.2 V
R1511S033B	S 3 3 B	3.3 V
R1511S034B	S 3 4 B	3.4 V
R1511S035B	S 3 5 B	3.5 V
R1511S036B	S 3 6 B	3.6 V
R1511S037B	S 3 7 B	3.7 V
R1511S038B	S 3 8 B	3.8 V
R1511S039B	S 3 9 B	3.9 V
R1511S040B	S 4 0 B	4.0 V
R1511S041B	S 4 1 B	4.1 V
R1511S042B	S 4 2 B	4.2 V
R1511S043B	S 4 3 B	4.3 V
R1511S044B	S 4 4 B	4.4 V
R1511S045B	S 4 5 B	4.5 V
R1511S046B	S 4 6 B	4.6 V
R1511S047B	S 4 7 B	4.7 V
R1511S048B	S 4 8 B	4.8 V
R1511S049B	S 4 9 B	4.9 V
R1511S050B	S 5 0 B	5.0 V
R1511S051B	S 5 1 B	5.1 V
R1511S052B	S 5 2 B	5.2 V
R1511S053B	S 5 3 B	5.3 V
R1511S054B	S 5 4 B	5.4 V
R1511S055B	S 5 5 B	5.5 V
R1511S056B	S 5 6 B	5.6 V
R1511S057B	S 5 7 B	5.7 V
R1511S058B	S 5 8 B	5.8 V
R1511S059B	S 5 9 B	5.9 V
R1511S060B	S 6 0 B	6.0 V
R1511S061B	S 6 1 B	6.1 V
R1511S062B	S 6 2 B	6.2 V
R1511S063B	S 6 3 B	6.3 V
R1511S064B	S 6 4 B	6.4 V
R1511S065B	S 6 5 B	6.5 V
R1511S066B	S 6 6 B	6.6 V
R1511S067B	S 6 7 B	6.7 V
R1511S068B	S 6 8 B	6.8 V
R1511S069B	S 6 9 B	6.9 V

Product Name	① ② ③ ④	V _{SET}
R1511S070B	S 7 0 B	7.0 V
R1511S071B	S 7 1 B	7.1 V
R1511S072B	S 7 2 B	7.2 V
R1511S073B	S 7 3 B	7.3 V
R1511S074B	S 7 4 B	7.4 V
R1511S075B	S 7 5 B	7.5 V
R1511S076B	S 7 6 B	7.6 V
R1511S077B	S 7 7 B	7.7 V
R1511S078B	S 7 8 B	7.8 V
R1511S079B	S 7 9 B	7.9 V
R1511S080B	S 8 0 B	8.0 V
R1511S081B	S 8 1 B	8.1 V
R1511S082B	S 8 2 B	8.2 V
R1511S083B	S 8 3 B	8.3 V
R1511S084B	S 8 4 B	8.4 V
R1511S085B	S 8 5 B	8.5 V
R1511S086B	S 8 6 B	8.6 V
R1511S087B	S 8 7 B	8.7 V
R1511S088B	S 8 8 B	8.8 V
R1511S089B	S 8 9 B	8.9 V
R1511S090B	S 9 0 B	9.0 V

R1511S001C

(Adjustable Output Voltage Setting Type)

Product Name	① ② ③ ④	V _{SET}
R1511S001C	S 0 0 C	—

POWER DISSIPATION (TO-252-5-P2)

The power dissipation of the package is dependent on PCB material, layout, and environmental conditions. The following measurement conditions are based on JEDEC STD. 51-7.

Measurement Conditions

Item	Measurement Conditions
Environment	Mounting on Board (Wind Velocity = 0 m/s)
Board Material	Glass Cloth Epoxy Plastic (Four-Layer Board)
Board Dimensions	76.2 mm × 114.3 mm × 0.8 mm
Copper Ratio	Outer Layer (First Layer): Less than 95% of 50 mm Square Inner Layers (Second and Third Layers): Approx. 100% of 50 mm Square Outer Layer (Fourth Layer): Approx. 100% of 50 mm Square
Through-holes	φ 0.3 mm × 21 pcs

Measurement Result (Ta = 25°C, Tjmax = 150°C)

Item	Measurement Result
Power Dissipation	4800 mW
Thermal Resistance (θ_{ja})	$\theta_{ja} = 26^{\circ}\text{C/W}$
Thermal Characterization Parameter (ψ_{jt})	$\psi_{jt} = 7^{\circ}\text{C/W}$

θ_{ja} : Junction-to-Ambient Thermal Resistance

ψ_{jt} : Junction-to-Top Thermal Characterization Parameter

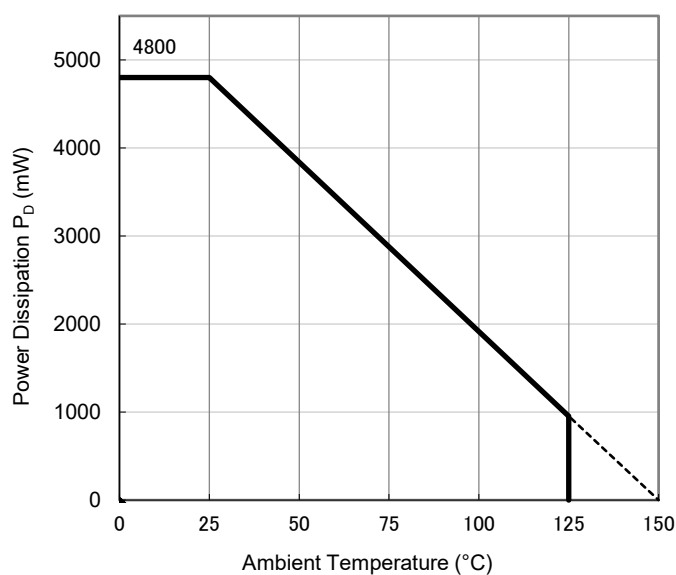

Power Dissipation vs. Ambient Temperature

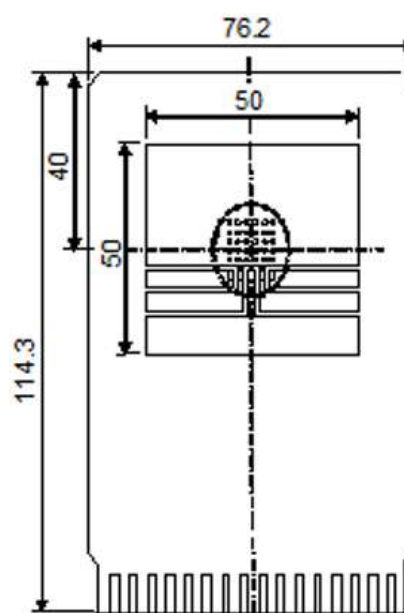

Measurement Board Pattern

PACKAGE DIMENSIONS (TO-252-5-P2)

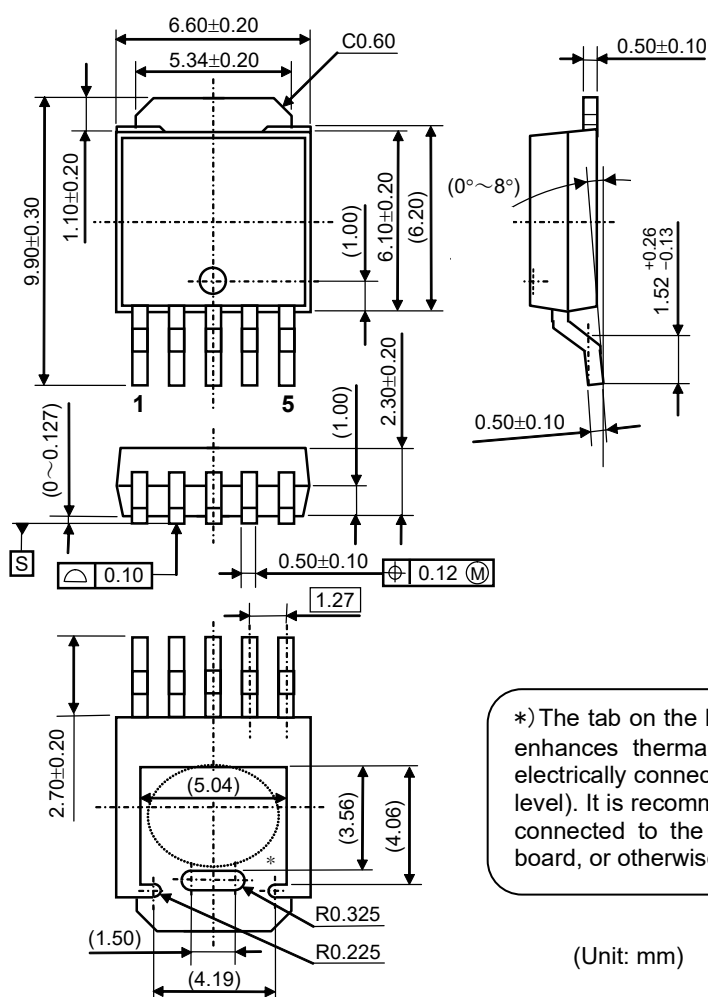

Package Dimensions (TO-252-5-P2)

MARK SPECIFICATION (TO-252-5-P2)

①②③④⑤⑥⑦⑧: Product Code ... **Refer to MARK SPECIFICATION TABLE**

⑨⑩: Lot Number ... Alphanumeric Serial Number

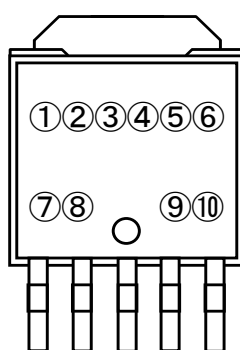

Mark Specification (TO-252-5-P2)

MARK SPECIFICATION TABLE (TO-252-5-P2)

R1511JxxxB

Product Name	①②③④⑤⑥⑦⑧	V _{SET}
R1511J030B	H 1 J 0 3 0 B	3.0 V
R1511J031B	H 1 J 0 3 1 B	3.1 V
R1511J032B	H 1 J 0 3 2 B	3.2 V
R1511J033B	H 1 J 0 3 3 B	3.3 V
R1511J034B	H 1 J 0 3 4 B	3.4 V
R1511J035B	H 1 J 0 3 5 B	3.5 V
R1511J036B	H 1 J 0 3 6 B	3.6 V
R1511J037B	H 1 J 0 3 7 B	3.7 V
R1511J038B	H 1 J 0 3 8 B	3.8 V
R1511J039B	H 1 J 0 3 9 B	3.9 V
R1511J040B	H 1 J 0 4 0 B	4.0 V
R1511J041B	H 1 J 0 4 1 B	4.1 V
R1511J042B	H 1 J 0 4 2 B	4.2 V
R1511J043B	H 1 J 0 4 3 B	4.3 V
R1511J044B	H 1 J 0 4 4 B	4.4 V
R1511J045B	H 1 J 0 4 5 B	4.5 V
R1511J046B	H 1 J 0 4 6 B	4.6 V
R1511J047B	H 1 J 0 4 7 B	4.7 V
R1511J048B	H 1 J 0 4 8 B	4.8 V
R1511J049B	H 1 J 0 4 9 B	4.9 V
R1511J050B	H 1 J 0 5 0 B	5.0 V
R1511J051B	H 1 J 0 5 1 B	5.1 V
R1511J052B	H 1 J 0 5 2 B	5.2 V
R1511J053B	H 1 J 0 5 3 B	5.3 V
R1511J054B	H 1 J 0 5 4 B	5.4 V
R1511J055B	H 1 J 0 5 5 B	5.5 V
R1511J056B	H 1 J 0 5 6 B	5.6 V
R1511J057B	H 1 J 0 5 7 B	5.7 V
R1511J058B	H 1 J 0 5 8 B	5.8 V
R1511J059B	H 1 J 0 5 9 B	5.9 V
R1511J060B	H 1 J 0 6 0 B	6.0 V
R1511J061B	H 1 J 0 6 1 B	6.1 V
R1511J062B	H 1 J 0 6 2 B	6.2 V
R1511J063B	H 1 J 0 6 3 B	6.3 V
R1511J064B	H 1 J 0 6 4 B	6.4 V
R1511J065B	H 1 J 0 6 5 B	6.5 V
R1511J066B	H 1 J 0 6 6 B	6.6 V
R1511J067B	H 1 J 0 6 7 B	6.7 V
R1511J068B	H 1 J 0 6 8 B	6.8 V
R1511J069B	H 1 J 0 6 9 B	6.9 V

Product Name	①②③④⑤⑥⑦⑧	V _{SET}
R1511J070B	H 1 J 0 7 0 B	7.0 V
R1511J071B	H 1 J 0 7 1 B	7.1 V
R1511J072B	H 1 J 0 7 2 B	7.2 V
R1511J073B	H 1 J 0 7 3 B	7.3 V
R1511J074B	H 1 J 0 7 4 B	7.4 V
R1511J075B	H 1 J 0 7 5 B	7.5 V
R1511J076B	H 1 J 0 7 6 B	7.6 V
R1511J077B	H 1 J 0 7 7 B	7.7 V
R1511J078B	H 1 J 0 7 8 B	7.8 V
R1511J079B	H 1 J 0 7 9 B	7.9 V
R1511J080B	H 1 J 0 8 0 B	8.0 V
R1511J081B	H 1 J 0 8 1 B	8.1 V
R1511J082B	H 1 J 0 8 2 B	8.2 V
R1511J083B	H 1 J 0 8 3 B	8.3 V
R1511J084B	H 1 J 0 8 4 B	8.4 V
R1511J085B	H 1 J 0 8 5 B	8.5 V
R1511J086B	H 1 J 0 8 6 B	8.6 V
R1511J087B	H 1 J 0 8 7 B	8.7 V
R1511J088B	H 1 J 0 8 8 B	8.8 V
R1511J089B	H 1 J 0 8 9 B	8.9 V
R1511J090B	H 1 J 0 9 0 B	9.0 V

R1511J001C

(Adjustable Output Voltage Setting Type)

Product Name	①②③④⑤⑥⑦⑧	V _{SET}
R1511J001C	H 1 J 0 0 1 C	—

TEST CIRCUITS

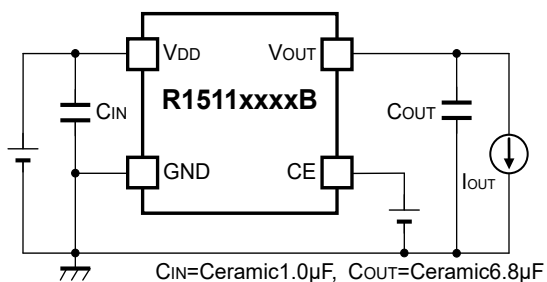

R1511xxxxB Basic Test Circuit

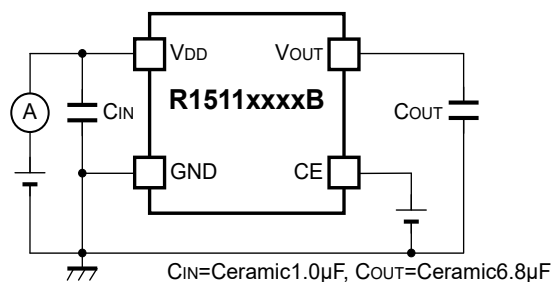

R1511xxxxB Test Circuit for Supply Current

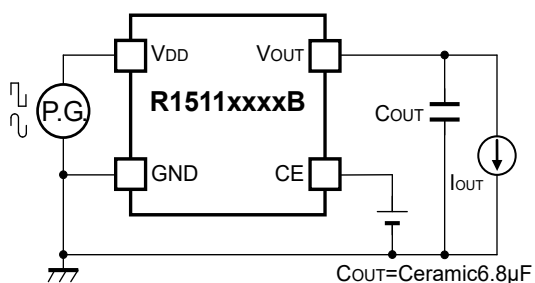

R1511xxxxB Test Circuit for Ripple Rejection and Regulator Input Transient Response

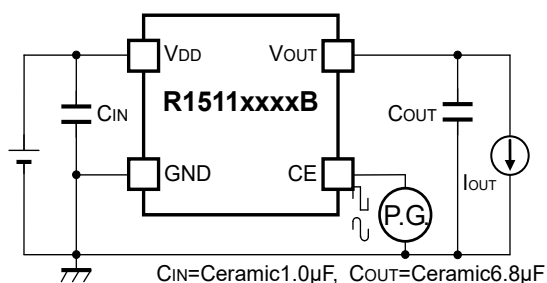

R1511xxxxB Test Circuit for CE Start-up

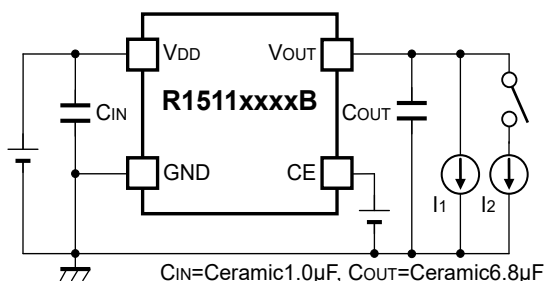

R1511xxxxB Test Circuit for Load Transient Response

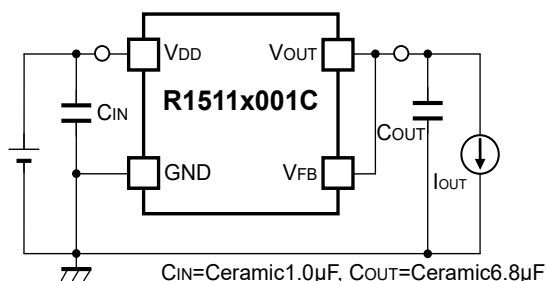

R1511x001C Basic Test Circuit

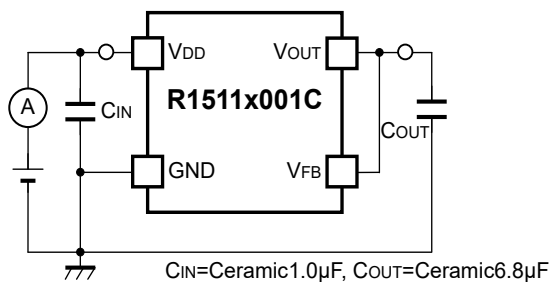

R1511x001C Test Circuit for Supply Current

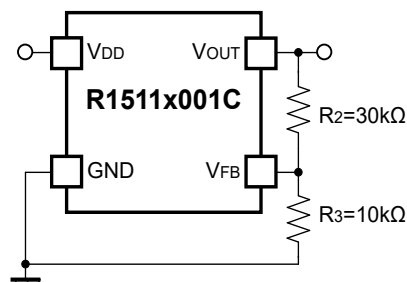

R1511x001C Case of output voltage adjustment by external resistors

TYPICAL CHARACTERISTICS

Note: Typical Characteristics are intended to be used as reference data; they are not guaranteed.

1) Output Voltage vs. Output Current (Ta = 25°C)

R1511x030B

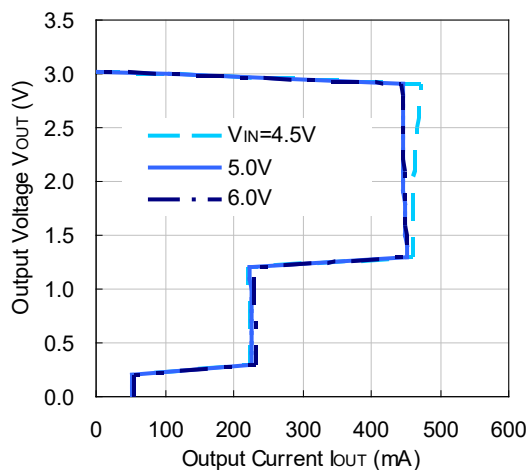

R1511x050B

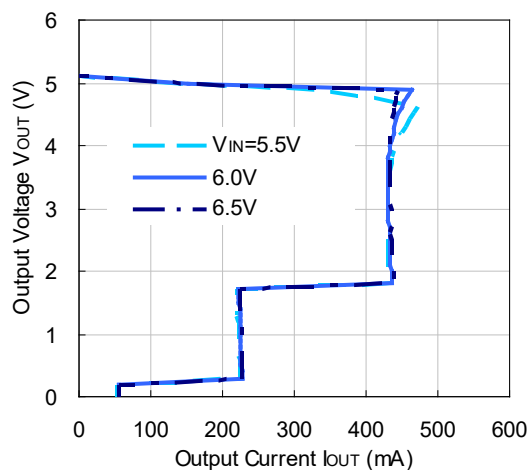

R1511x090B

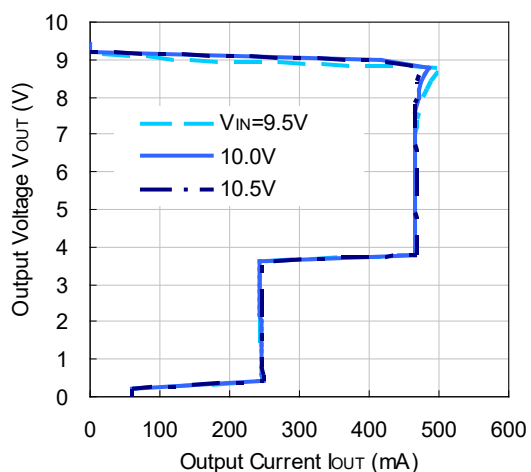

R1511x001C

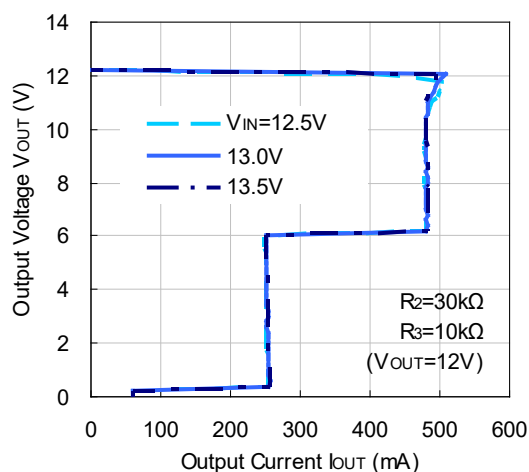

2) Output Voltage vs. Input Voltage (Ta = 25°C)

R1511x030B

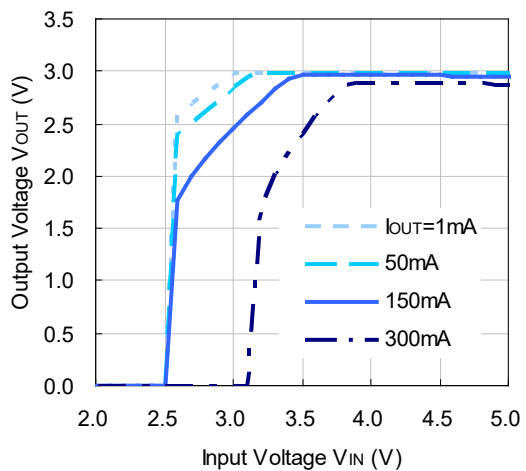

R1511x050B

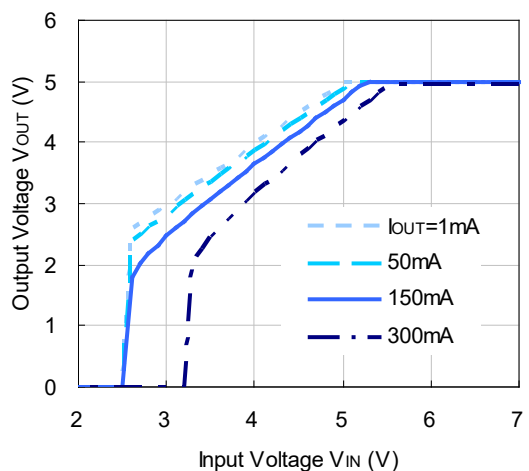

R1511x090B

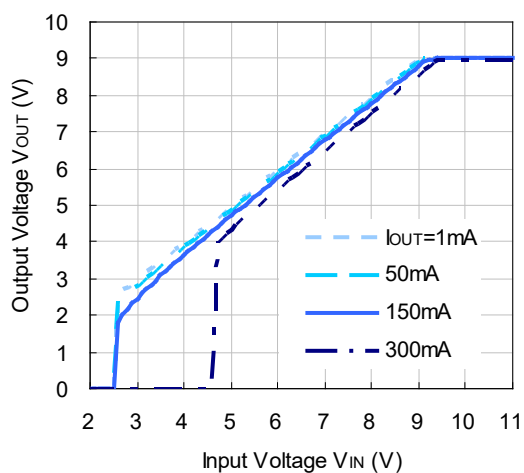

R1511x001C

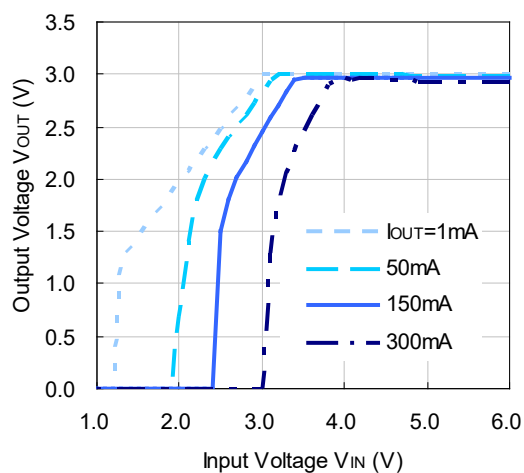

3) Supply Current vs. Input Voltage

R1511x030B

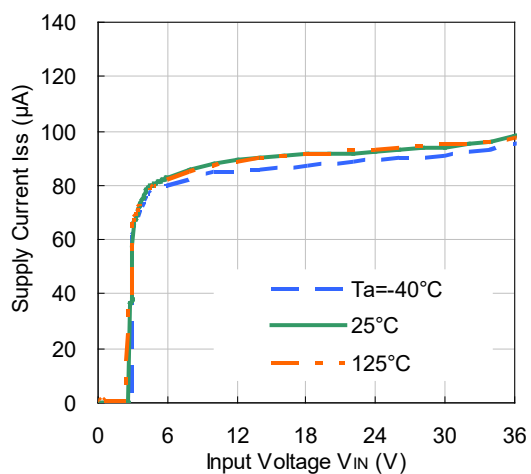

R1511x050B

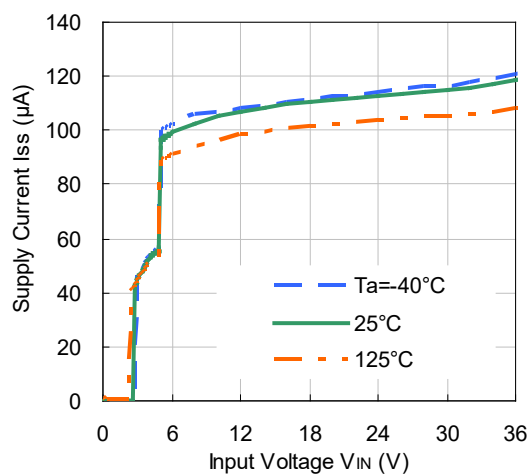

R1511x090B

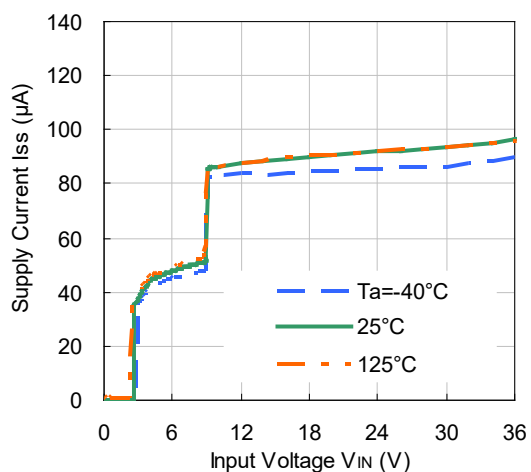

R1511x001C

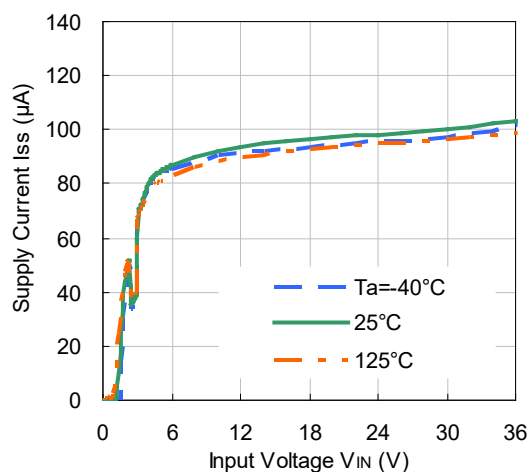

4) Output Voltage vs. Ambient Temperature

R1511x030B

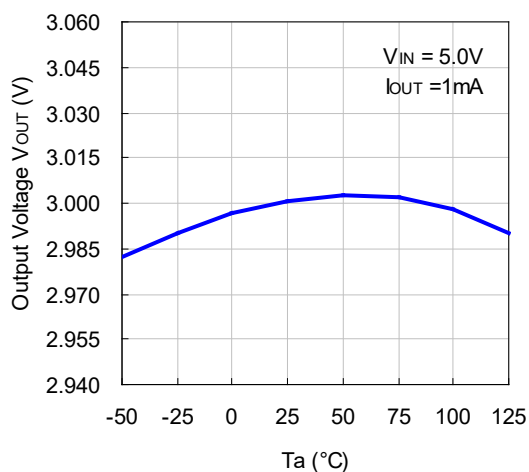

R1511x050B

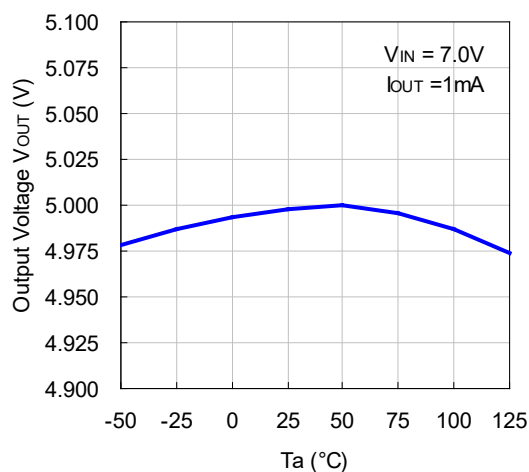

R1511x090B

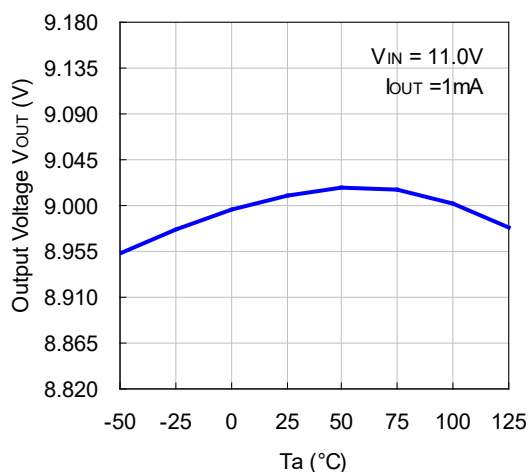

R1511x001C

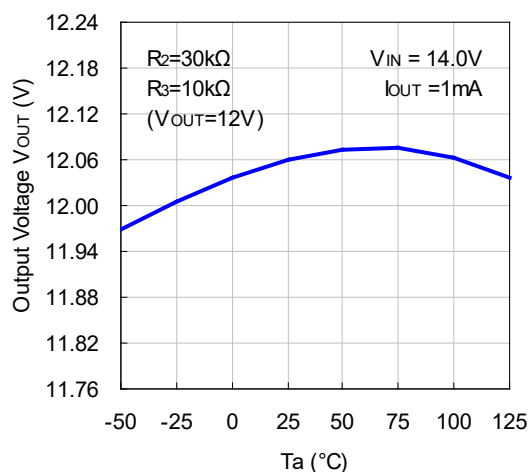

5) Dropout Voltage vs. Output Current

R1511x030B/R1511x001C

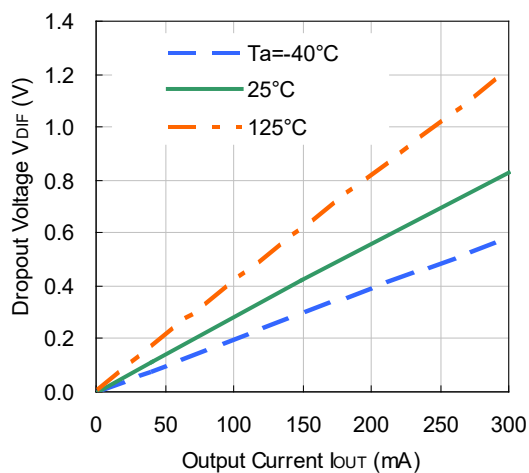

R1511x050B

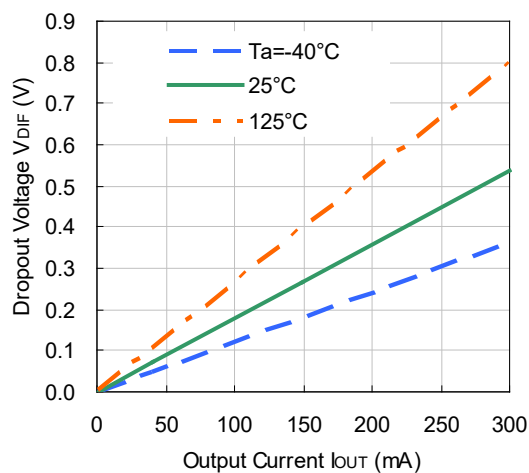

R1511x090B

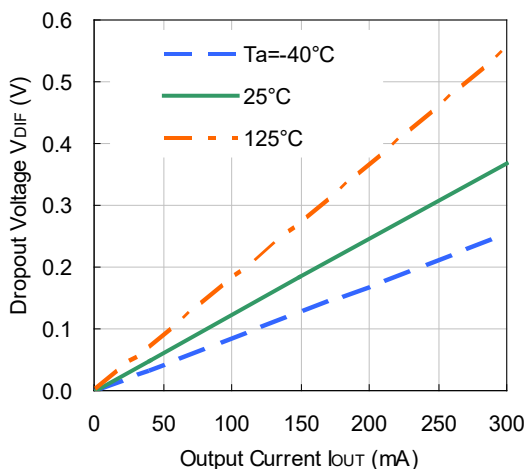

6) Dropout Voltage vs. Setting Voltage ($T_a = 25^\circ\text{C}$)

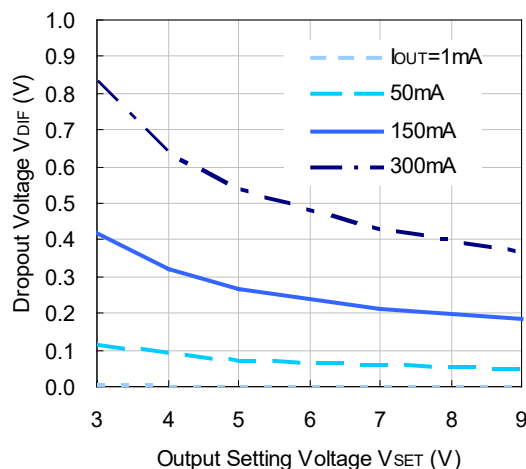

7) Ripple Rejection vs. Input Bias Voltage ($T_a = 25^\circ\text{C}$, Ripple = 0.5 Vpp)

R1511x030B/R1511x001C ($I_{OUT} = 1\text{mA}$)

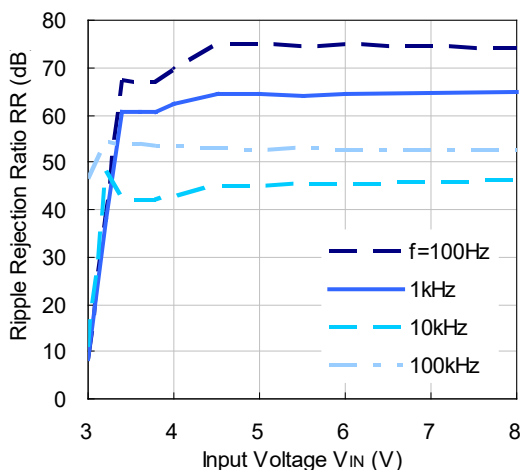

R1511x030B/R1511x001C ($I_{OUT} = 100\text{mA}$)

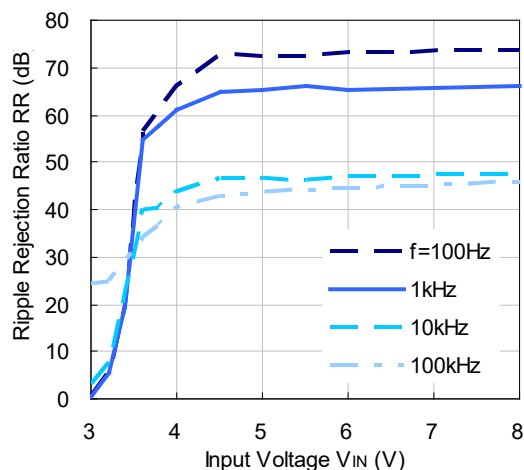

R1511x050B ($I_{OUT} = 1\text{mA}$)

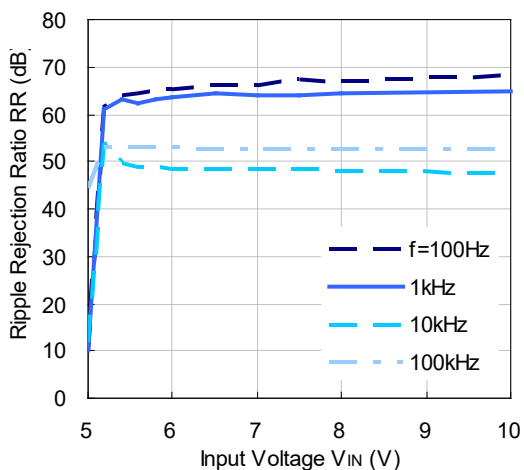

R1511x050B ($I_{OUT} = 100\text{mA}$)

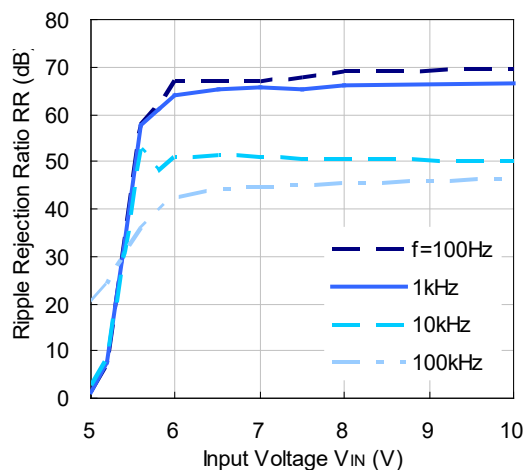

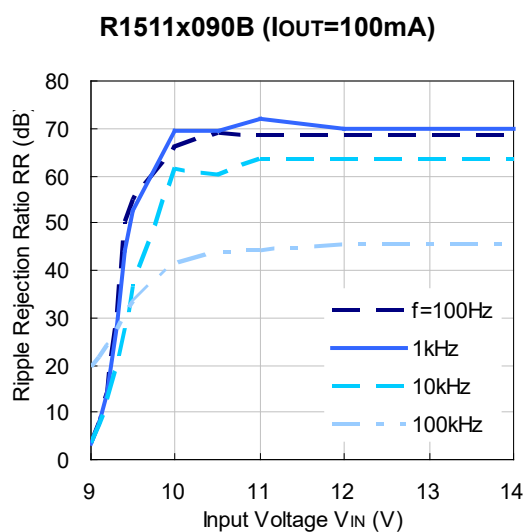
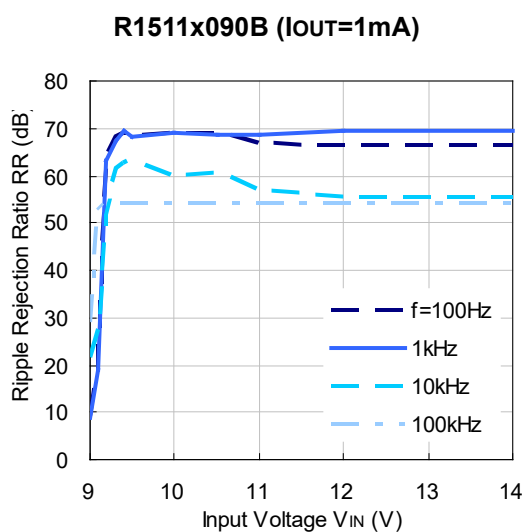

8) Ripple Rejection vs. Frequency (Ta = 25°C, Ripple = 0.5 Vpp)

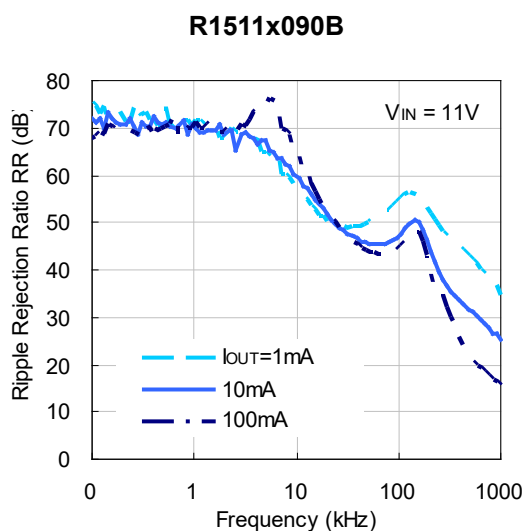
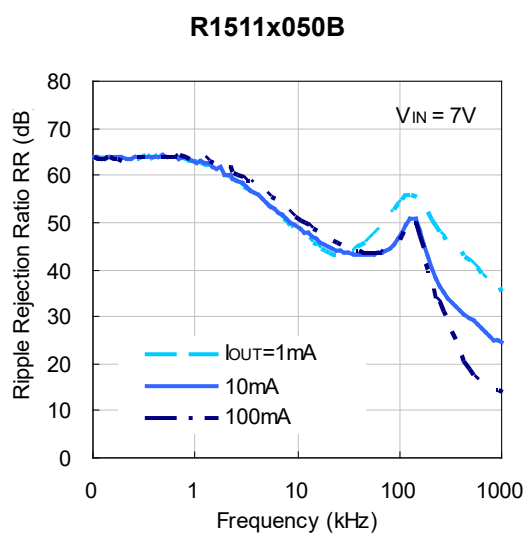
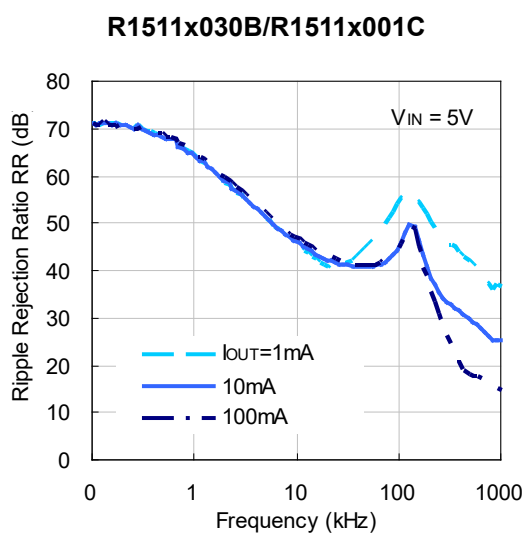

9) Input Transient Response (Ta = 25°C)

R1511x030B

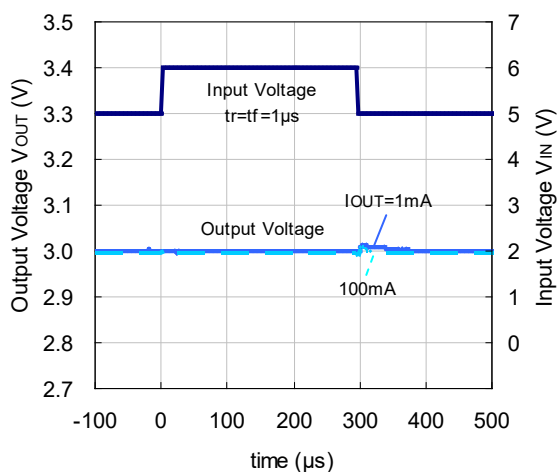

R1511x050B

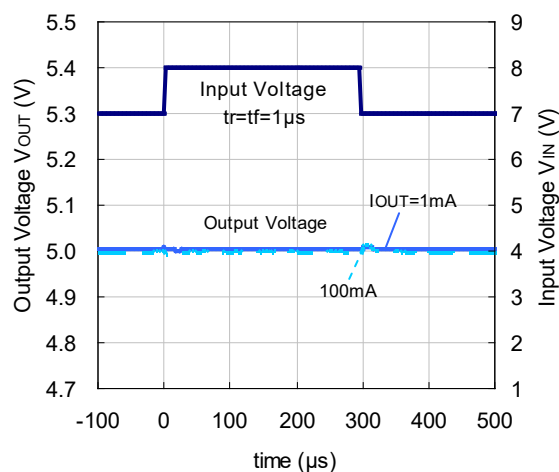

R1511x090B

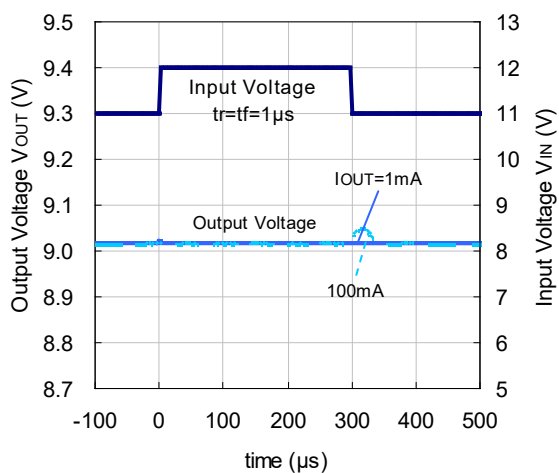

10) Load Transient Response (Ta = 25°C)

R1511x030B

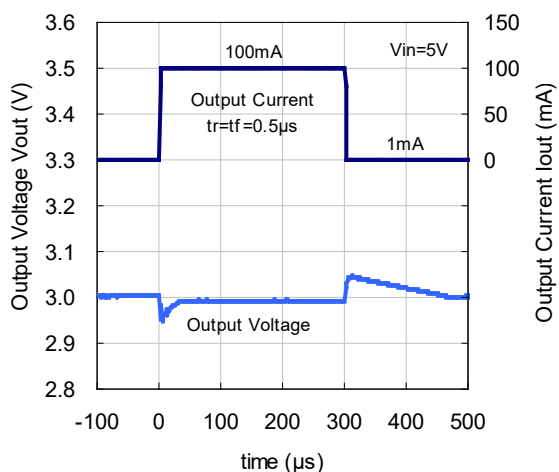

R1511x050B

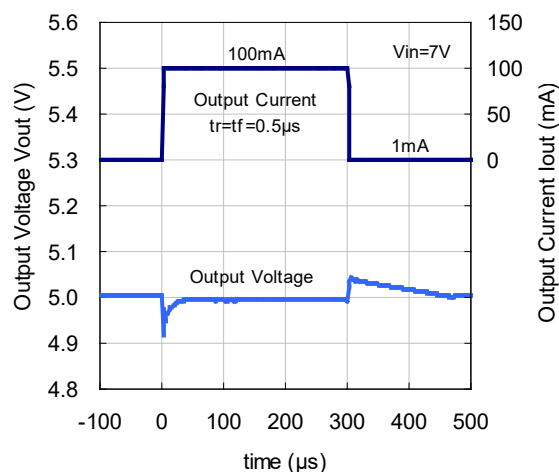

R1511x090B

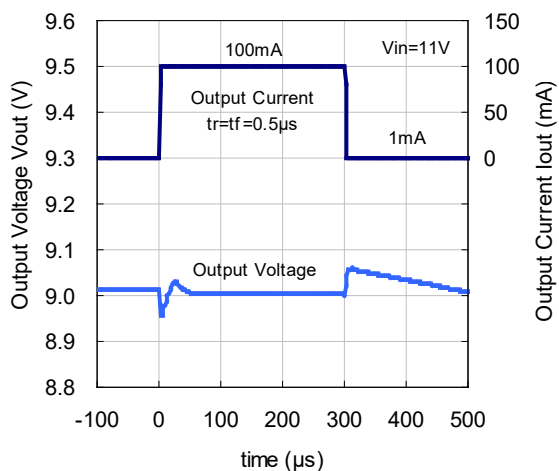

11) CE Response ($T_a = 25^{\circ}C$)

R1511x030B (Turn On)

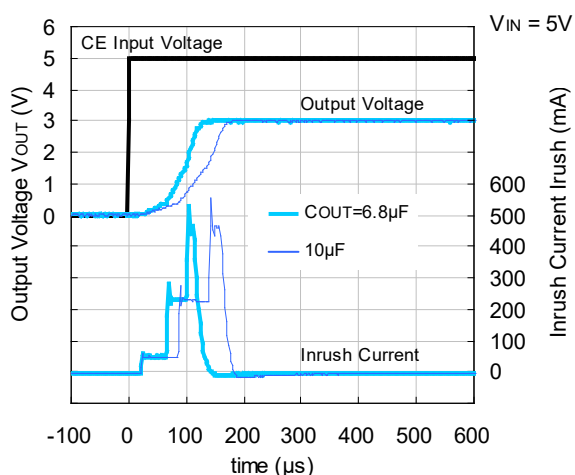

R1511x030B (Turn Off)

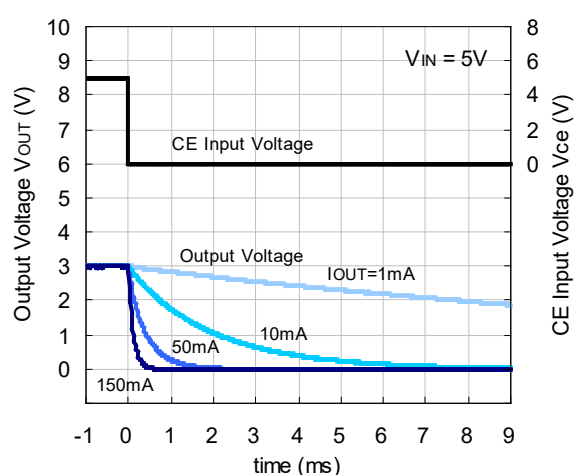

R1511x050B (Turn On)

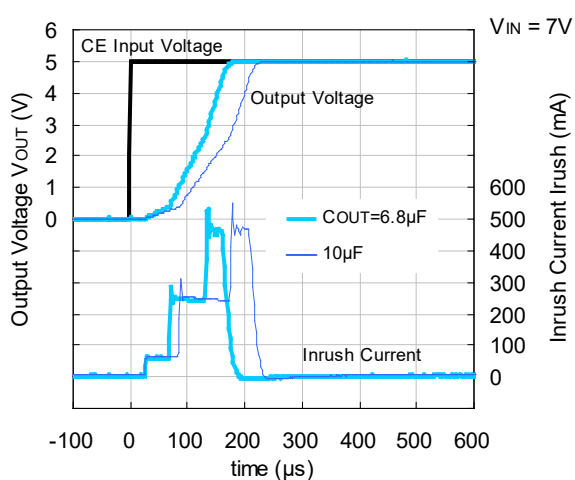

R1511x050B (Turn Off)

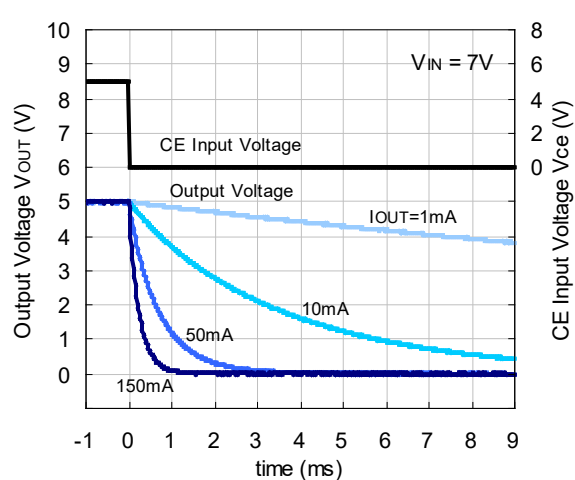

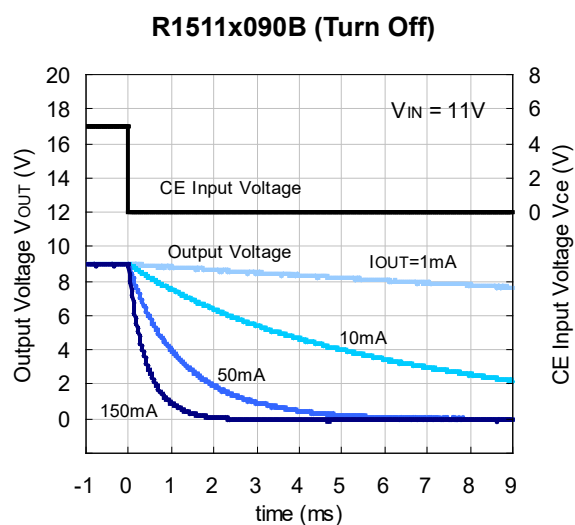
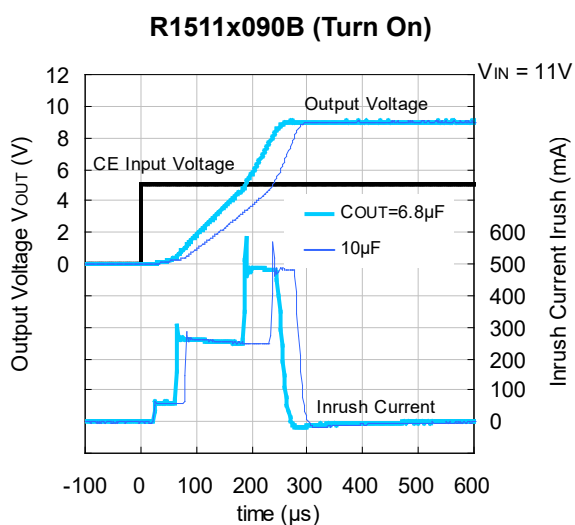

12) Start Up Waveform ($T_a = 25^\circ C$)

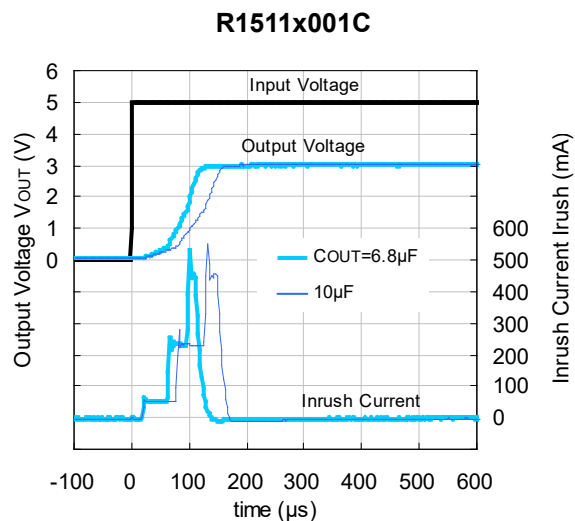
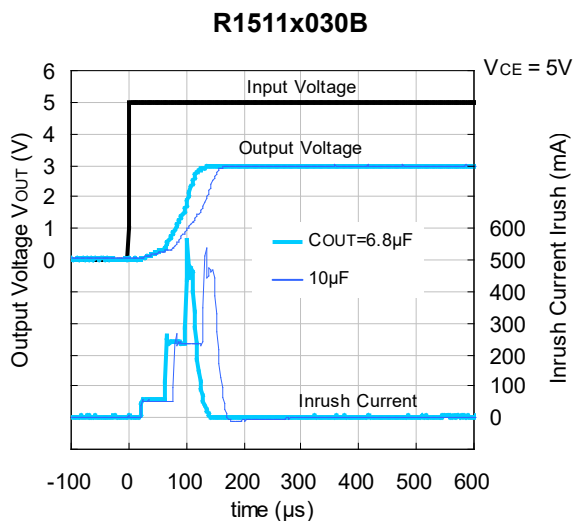

13) CE Pin Current Vs. CE Input Voltage

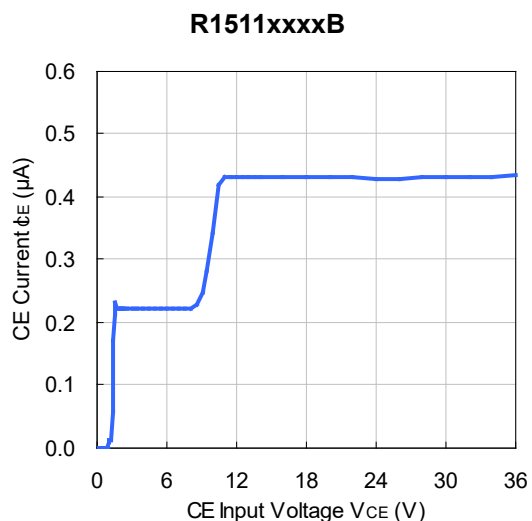

EQUIVALENT SERIES RESISTANCE (ESR) vs. OUTPUT CURRENT

Ceramic type output capacitor is recommended for this device; however, the other output capacitors with low ESR also can be used. As for reference, the below graphs show the relationship between output current (I_{OUT}) and equivalent series resistance (ESR). The noise level of the output current (I_{OUT}) was measured by the test circuit and is lower than the specified value.

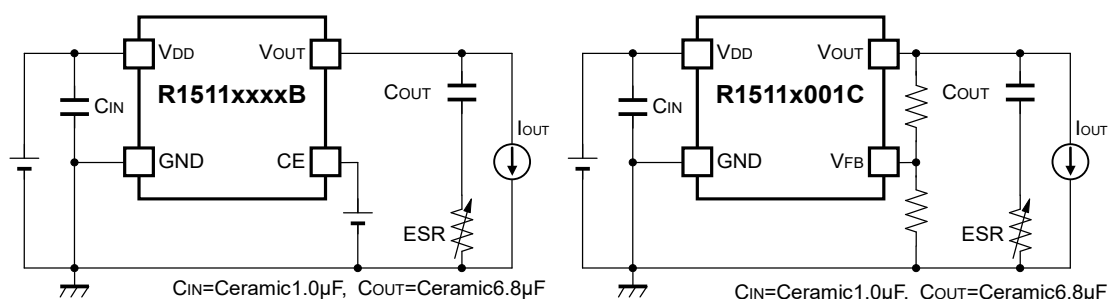

Measurement Conditions

- Noise Frequency Range: 10Hz to 2MHz
- Ambient Temperature: -40°C to 125°C
- Shaded Area: Noise level is lower than the specified value (40 μ V)
- Capacitor: C_{IN} =Ceramic 1.0 μ F, C_{OUT} =Ceramic 6.8 μ F (C4532X7S1H685K)

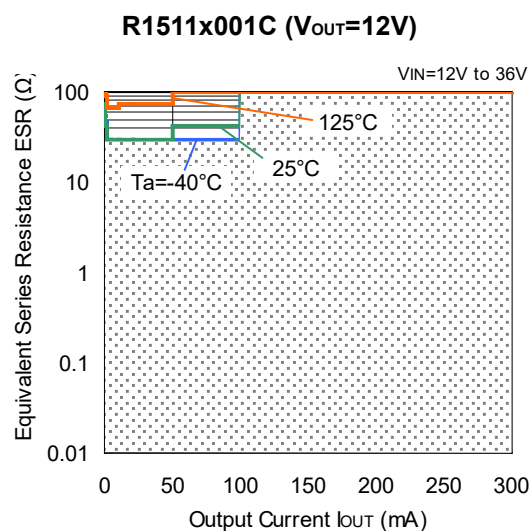
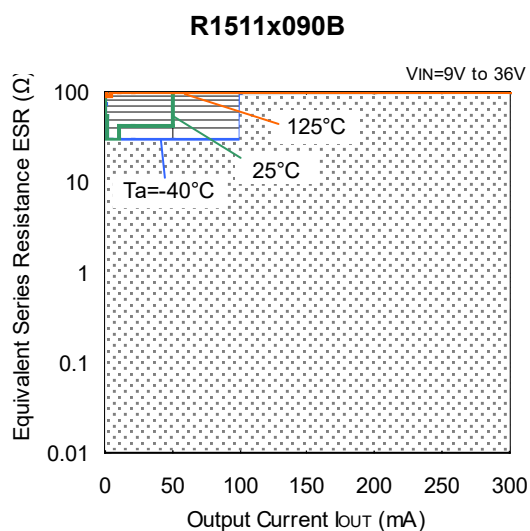
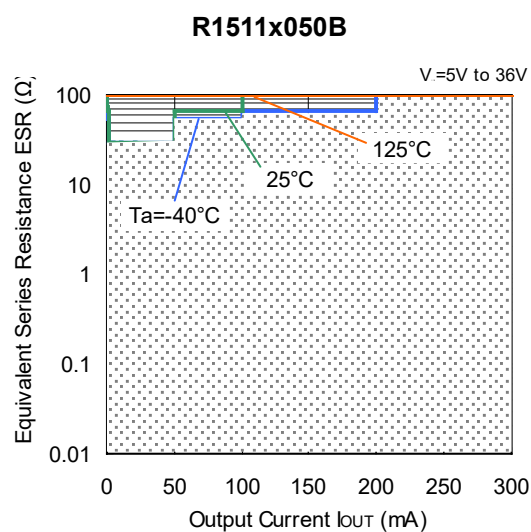
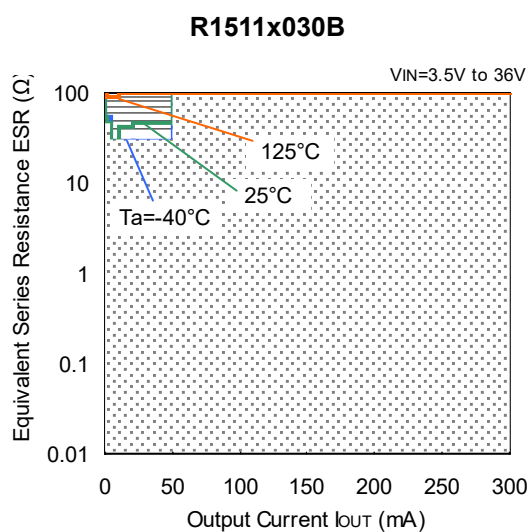

1. The products and the product specifications described in this document are subject to change or discontinuation of production without notice for reasons such as improvement. Therefore, before deciding to use the products, please refer to our sales representatives for the latest information thereon.
2. The materials in this document may not be copied or otherwise reproduced in whole or in part without the prior written consent of us.
3. This product and any technical information relating thereto are subject to complementary export controls (so-called KNOW controls) under the Foreign Exchange and Foreign Trade Law, and related politics ministerial ordinance of the law. (Note that the complementary export controls are inapplicable to any application-specific products, except rockets and pilotless aircraft, that are insusceptible to design or program changes.) Accordingly, when exporting or carrying abroad this product, follow the Foreign Exchange and Foreign Trade Control Law and its related regulations with respect to the complementary export controls.
4. The technical information described in this document shows typical characteristics and example application circuits for the products. The release of such information is not to be construed as a warranty of or a grant of license under our or any third party's intellectual property rights or any other rights.
5. The products listed in this document are intended and designed for automotive applications. Those customers intending to use a product in an application requiring extreme quality and reliability, for example, in a highly specific application where the failure or misoperation of the product could result in human injury or death should first contact us.
 - Aerospace Equipment
 - Equipment Used in the Deep Sea
 - Power Generator Control Equipment (nuclear, steam, hydraulic, etc.)
 - Life Maintenance Medical Equipment
 - Fire Alarms / Intruder Detectors
 - Vehicle Control Equipment (airplane, railroad, ship, etc.)
 - Various Safety Devices
 - Traffic control system
 - Combustion equipment

In case your company desires to use this product for any applications other than general electronic equipment mentioned above, make sure to contact our company in advance. Note that the important requirements mentioned in this section are not applicable to cases where operation requirements such as application conditions are confirmed by our company in writing after consultation with your company.

6. We are making our continuous effort to improve the quality and reliability of our products, but semiconductor products are likely to fail with certain probability. In order to prevent any injury to persons or damages to property resulting from such failure, customers should be careful enough to incorporate safety measures in their design, such as redundancy feature, fire containment feature and fail-safe feature. We do not assume any liability or responsibility for any loss or damage arising from misuse or inappropriate use of the products.
7. The products have been designed and tested to function within controlled environmental conditions. Do not use products under conditions that deviate from methods or applications specified in this datasheet. Failure to employ the products in the proper applications can lead to deterioration, destruction or failure of the products. We shall not be responsible for any bodily injury, fires or accident, property damage or any consequential damages resulting from misuse or misapplication of the products.
8. Quality Warranty
 - 8-1. Quality Warranty Period

In the case of a product purchased through an authorized distributor or directly from us, the warranty period for this product shall be one (1) year after delivery to your company. For defective products that occurred during this period, we will take the quality warranty measures described in section 8-2. However, if there is an agreement on the warranty period in the basic transaction agreement, quality assurance agreement, delivery specifications, etc., it shall be followed.
 - 8-2. Quality Warranty Remedies

When it has been proved defective due to manufacturing factors as a result of defect analysis by us, we will either deliver a substitute for the defective product or refund the purchase price of the defective product.
Note that such delivery or refund is sole and exclusive remedies to your company for the defective product.
 - 8-3. Remedies after Quality Warranty Period

With respect to any defect of this product found after the quality warranty period, the defect will be analyzed by us. On the basis of the defect analysis results, the scope and amounts of damage shall be determined by mutual agreement of both parties. Then we will deal with upper limit in Section 8-2. This provision is not intended to limit any legal rights of your company.
9. Anti-radiation design is not implemented in the products described in this document.
10. The X-ray exposure can influence functions and characteristics of the products. Confirm the product functions and characteristics in the evaluation stage.
11. WLCSP products should be used in light shielded environments. The light exposure can influence functions and characteristics of the products under operation or storage.
12. Warning for handling Gallium and Arsenic (GaAs) products (Applying to GaAs MMIC, Photo Reflector). These products use Gallium (Ga) and Arsenic (As) which are specified as poisonous chemicals by law. For the prevention of a hazard, do not burn, destroy, or process chemically to make them as gas or power. When the product is disposed of, please follow the related regulation and do not mix this with general industrial waste or household waste.
13. Please contact our sales representatives should you have any questions or comments concerning the products or the technical information.



Nisshinbo Micro Devices Inc.

Official website

<https://www.nisshinbo-microdevices.co.jp/en/>

Purchase information

<https://www.nisshinbo-microdevices.co.jp/en/buy/>