

Series: Stubby Antenna

Description:

Tri-Band 868/915/2400-2500MHz, Straight

PART NUMBER: W1698/W1699/W1698-M



W1698 / W1699



W1698-M

Features:

- Small form factor monopole
- Antenna size W x H:
W1698 / W1699 (10.4 x 49.6mm)
W1698-M (12 x 50mm)
- Connector Type:
W1698 SMA (male)
W1699 RP-SMA (male)
W1698-M SMA (male)
- RoHS Compliant Product

Applications:

- Tri-band Combo
- Frequency range:
868 / 915 / 2400 - 2500 MHz
- IoT, M2M Applications
- Sigfox, Lora
- Bluetooth, BLE, WiFi

All dimensions are in mm

Issue: 1911

In the effort to improve our products, we reserve the right to make changes judged to be necessary.

CONFIDENTIAL AND PROPRIETARY INFORMATION

This document contains confidential and proprietary information of Pulse Electronics, Inc. (Pulse) and is protected by copyright, trade secret and other state and federal laws. Its receipt or possession does not convey any rights to reproduce, disclose its contents, or to manufacture, use or sell anything it may describe. Reproduction, disclosure or use without specific written authorization of Pulse is strictly forbidden.

For more information:

Pulse Worldwide Headquarters
15255 Innovation Drive #100
San Diego, CA 92128
USA
Tel:1-858-674-8100

Pulse/Larsen Antennas
18110 SE 34th St Bldg 2 Suite 250
Vancouver, WA 98683
USA
Tel: 1-360-944-7551

Europe Headquarters
Pulse GmbH & Do, KG
Zeppelinstrasse 15
Herrenberg, Germany
Tel: 49 7032 7806 0

Pulse (Suzhou) Wireless Products Co, Inc.
99 Huo Ju Road(#29 Bldg,4th Phase
Suzhou New District
Jiangsu Province, Suzhou 215009 PR China
Tel: 86 512 6807 9998



Series: Stubby Antenna

Description:

Tri-Band 868/915/2400-2500MHz, Straight

PART NUMBER: W1698/W1699/W1698-M

ELECTRICAL SPECIFICATIONS

Frequency	868-928MHz 2400-2500MHz
Nominal Impedance	50Ω
VSWR	3 868-928MHz 3 2400-2500MHz
Peak Gain	0.3dBi 868-928MHz 1.2dBi 2400-2500MHz
Efficiency	64% / 70%
Radiation Pattern	Omni
Polarization:	Linear
Power withstanding	5W

Issue: 1911

In the effort to improve our products, we reserve the right to make changes judged to be necessary.

CONFIDENTIAL AND PROPRIETARY INFORMATION

This document contains confidential and proprietary information of Pulse Electronics, Inc. (Pulse) and is protected by copyright, trade secret and other state and federal laws. Its receipt or possession does not convey any rights to reproduce, disclose its contents, or to manufacture, use or sell anything it may describe. Reproduction, disclosure or use without specific written authorization of Pulse is strictly forbidden.

For more information:

Pulse Worldwide Headquarters
15255 Innovation Drive #100
San Diego, CA 92128
USA
Tel:1-858-674-8100

Pulse/Larsen Antennas
18110 SE 34th St Bldg 2 Suite 250
Vancouver, WA 98683
USA
Tel: 1-360-944-7551

Europe Headquarters
Pulse GmbH & Do, KG
Zeppelinstrasse 15
Herrenberg, Germany
Tel: 49 7032 7806 0

Pulse (Suzhou) Wireless Products Co, Inc.
99 Huo Ju Road(#29 Bldg,4th Phase
Suzhou New District
Jiangsu Province, Suzhou 215009 PR China
Tel: 86 512 6807 9998



Series: Stubby Antenna

Description:

Tri-Band 868/915/2400-2500MHz, Straight

PART NUMBER: W1698/W1699/W1698-M

MECHANICAL SPECIFICATIONS

Weight	W1698 / W1699: 7.5g W1698-M: 7.8g
Antenna Color	Black
Connector type	W1698/W1698-M SMA(Male) W1699 RP-SMA(Male)

ENVIRONMENTAL SPECIFICATIONS

Operating Temperature	-30/+75 ° C
Storage Temperature	-30/+75 ° C
Ingress Protection	IP65 (W1698-M) IP42 (W1698 and W1699)
Wind-loading	100km/h
RoHS Compliant	Yes

Series: Stubby Antenna

Description:

Tri-Band 868/915/2400-2500MHz, Straight

PART NUMBER: W1698/W1699/W1698-M

MECHANICAL DRAWING

W1698 / W1699

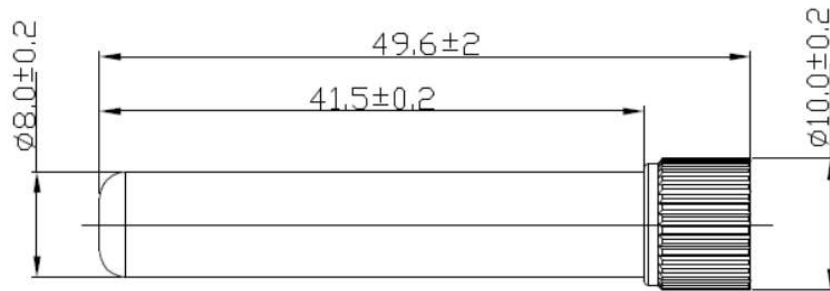

W1698-M

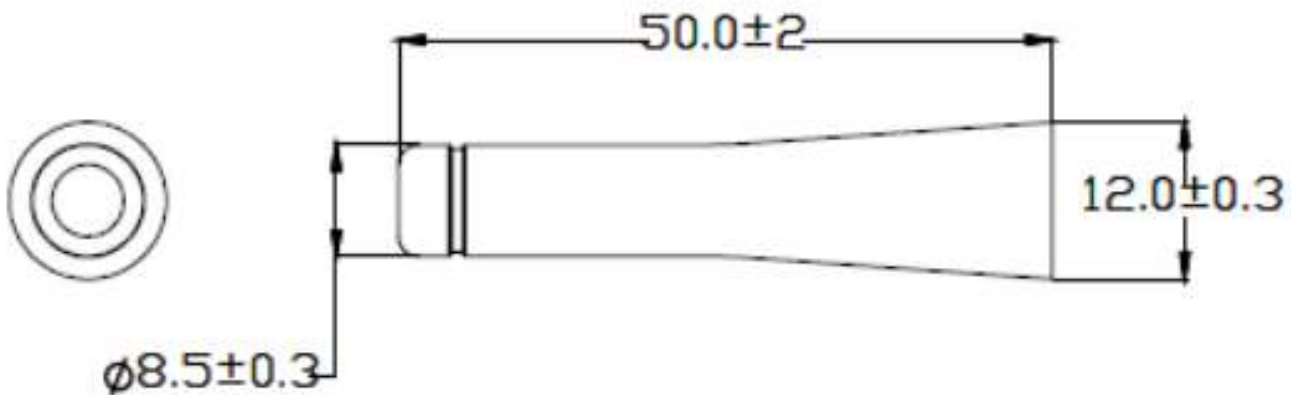

Issue: 1911

In the effort to improve our products, we reserve the right to make changes judged to be necessary.

CONFIDENTIAL AND PROPRIETARY INFORMATION

This document contains confidential and proprietary information of Pulse Electronics, Inc. (Pulse) and is protected by copyright, trade secret and other state and federal laws. Its receipt or possession does not convey any rights to reproduce, disclose its contents, or to manufacture, use or sell anything it may describe. Reproduction, disclosure or use without specific written authorization of Pulse is strictly forbidden.

Series: Stubby Antenna

Description:

Tri-Band 868/915/2400-2500MHz, Straight

PART NUMBER: W1698/W1699/W1698-M

TEST SETUP

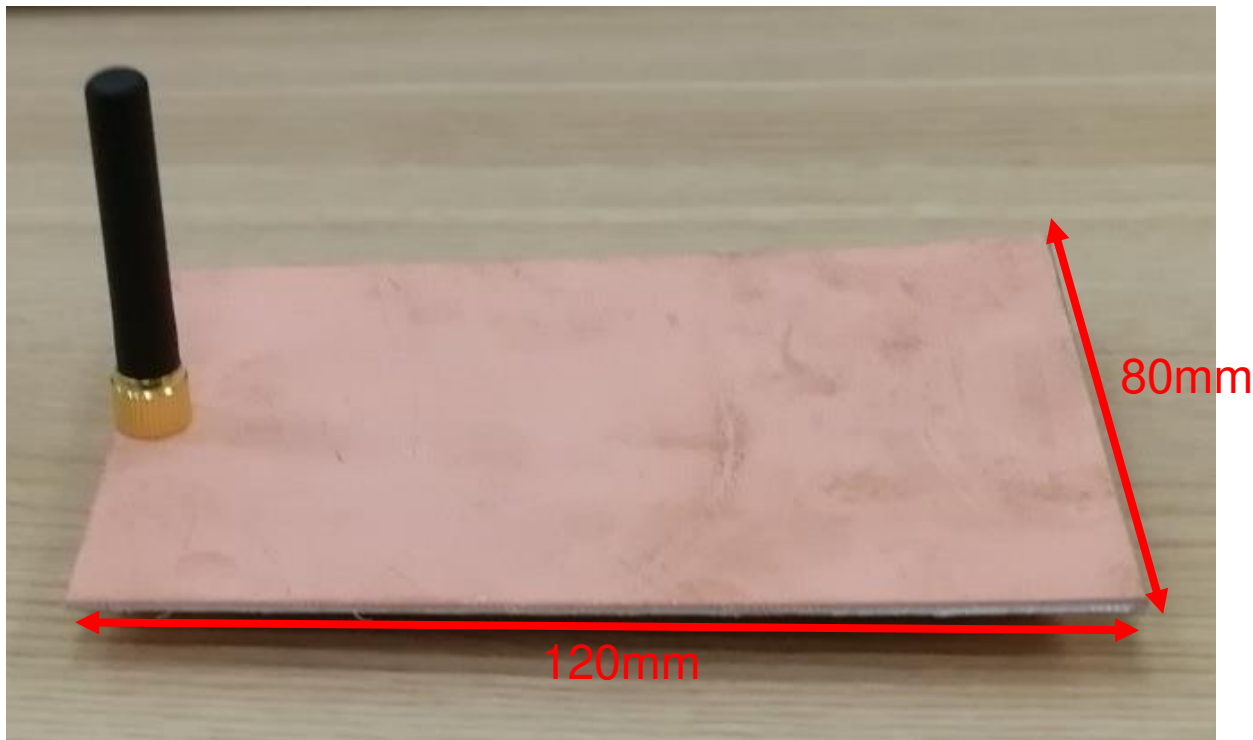

Test with 80mm*120mm ground plane.

Series: Stubby Antenna

Description:

Tri-Band 868/915/2400-2500MHz, Straight

PART NUMBER: W1698/W1699/W1698-M

CHARTS

Return Loss vs Frequency

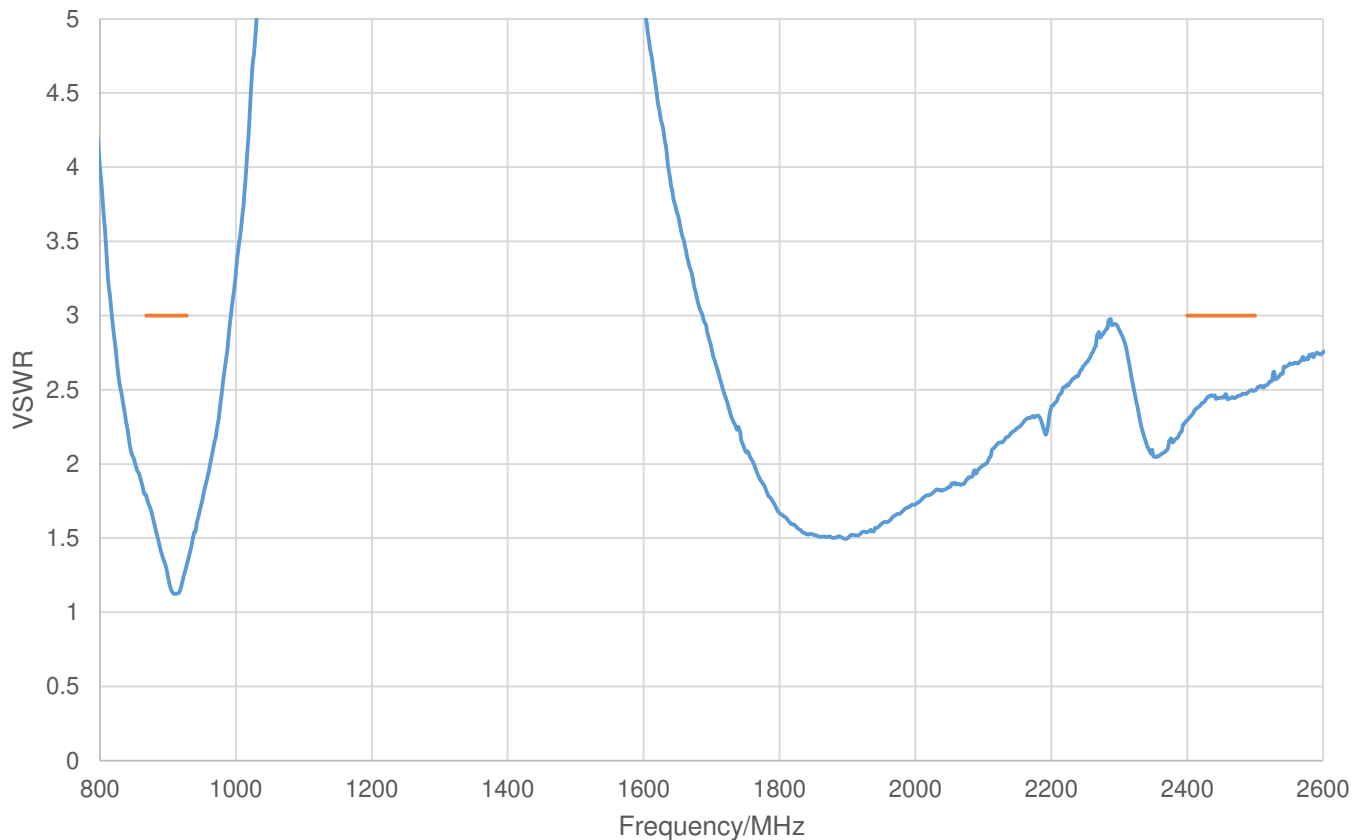

Issue: 1911

In the effort to improve our products, we reserve the right to make changes judged to be necessary.

CONFIDENTIAL AND PROPRIETARY INFORMATION

This document contains confidential and proprietary information of Pulse Electronics, Inc. (Pulse) and is protected by copyright, trade secret and other state and federal laws. Its receipt or possession does not convey any rights to reproduce, disclose its contents, or to manufacture, use or sell anything it may describe. Reproduction, disclosure or use without specific written authorization of Pulse is strictly forbidden.

Series: Stubby Antenna

Description:

Tri-Band 868/915/2400-2500MHz, Straight

PART NUMBER: W1698/W1699/W1698-M

CHARTS

Peak Gain vs Frequency

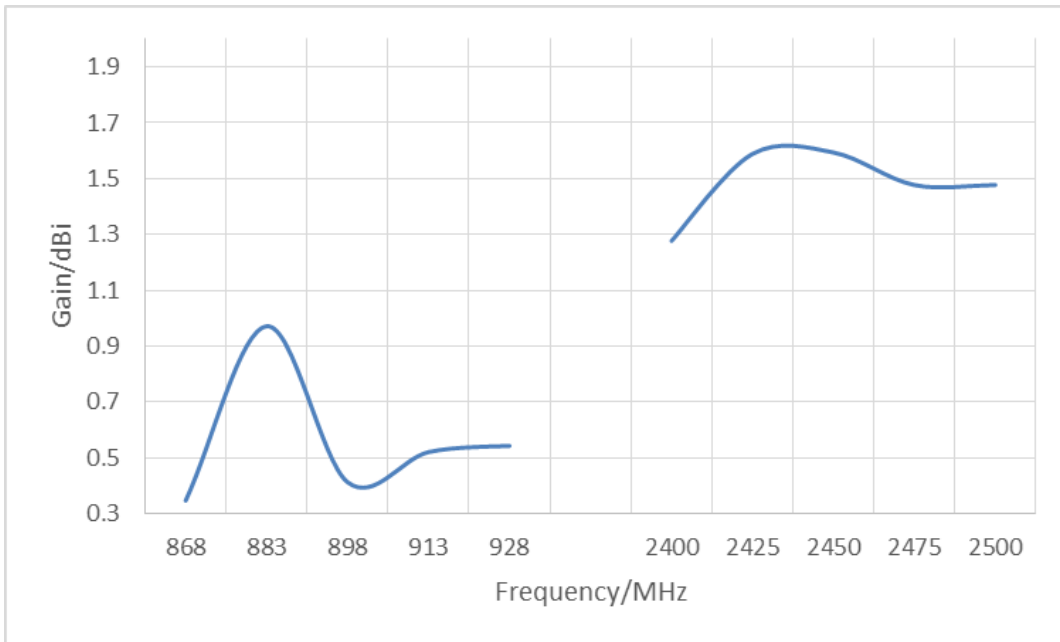

Radiation Efficiency vs Frequency

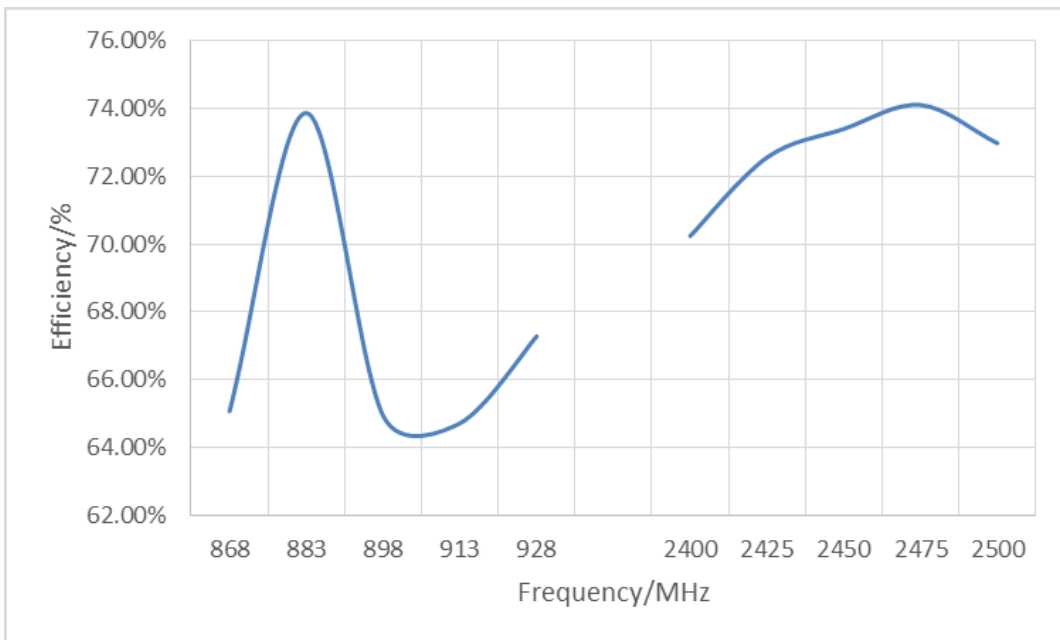

Issue: 1911

In the effort to improve our products, we reserve the right to make changes judged to be necessary.

CONFIDENTIAL AND PROPRIETARY INFORMATION

This document contains confidential and proprietary information of Pulse Electronics, Inc. (Pulse) and is protected by copyright, trade secret and other state and federal laws. Its receipt or possession does not convey any rights to reproduce, disclose its contents, or to manufacture, use or sell anything it may describe. Reproduction, disclosure or use without specific written authorization of Pulse is strictly forbidden.

Series: Stubby Antenna

Description:

Tri-Band 868/915/2400-2500MHz, Straight

PART NUMBER: W1698/W1699/W1698-M

CHARTS

Free Space Radiation Pattern(868-928MHz)

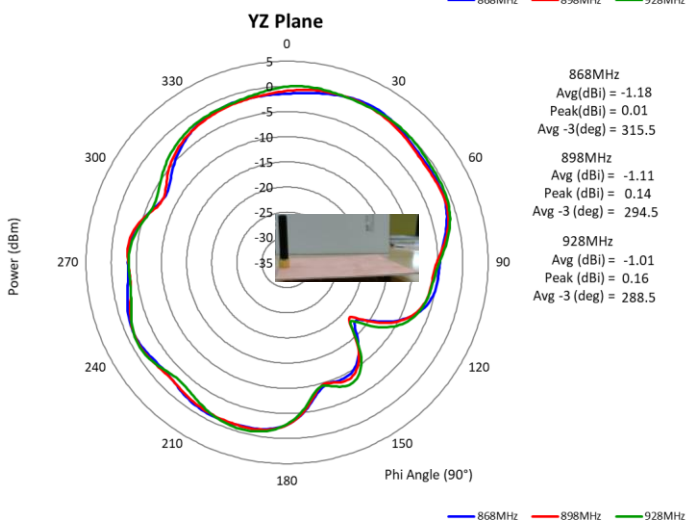
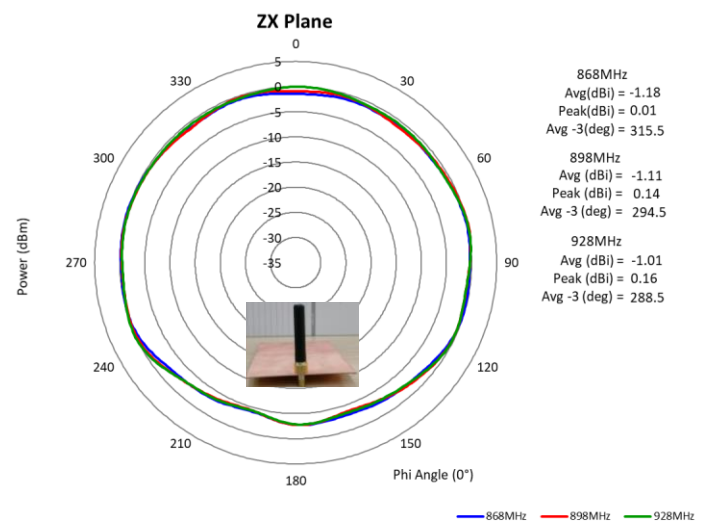
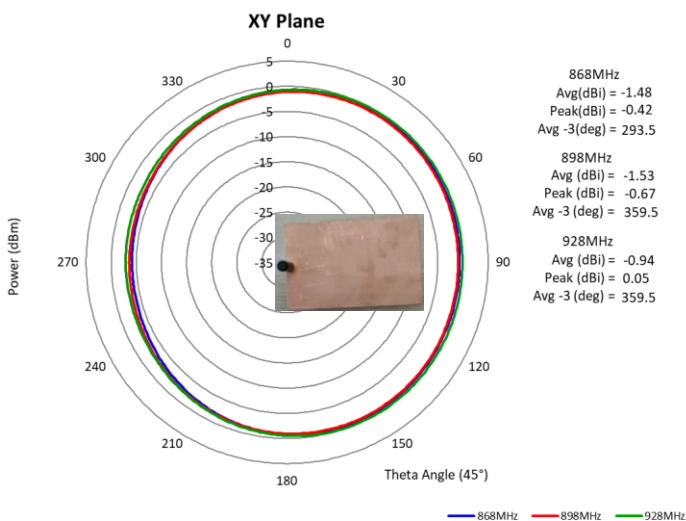

Issue: 1911

In the effort to improve our products, we reserve the right to make changes judged to be necessary.

CONFIDENTIAL AND PROPRIETARY INFORMATION

This document contains confidential and proprietary information of Pulse Electronics, Inc. (Pulse) and is protected by copyright, trade secret and other state and federal laws. Its receipt or possession does not convey any rights to reproduce, disclose its contents, or to manufacture, use or sell anything it may describe. Reproduction, disclosure or use without specific written authorization of Pulse is strictly forbidden.

Series: Stubby Antenna

Description:

Tri-Band 868/915/2400-2500MHz, Straight

PART NUMBER: W1698/W1699/W1698-M

CHARTS

Free Space Radiation Pattern(2400-2500MHz)

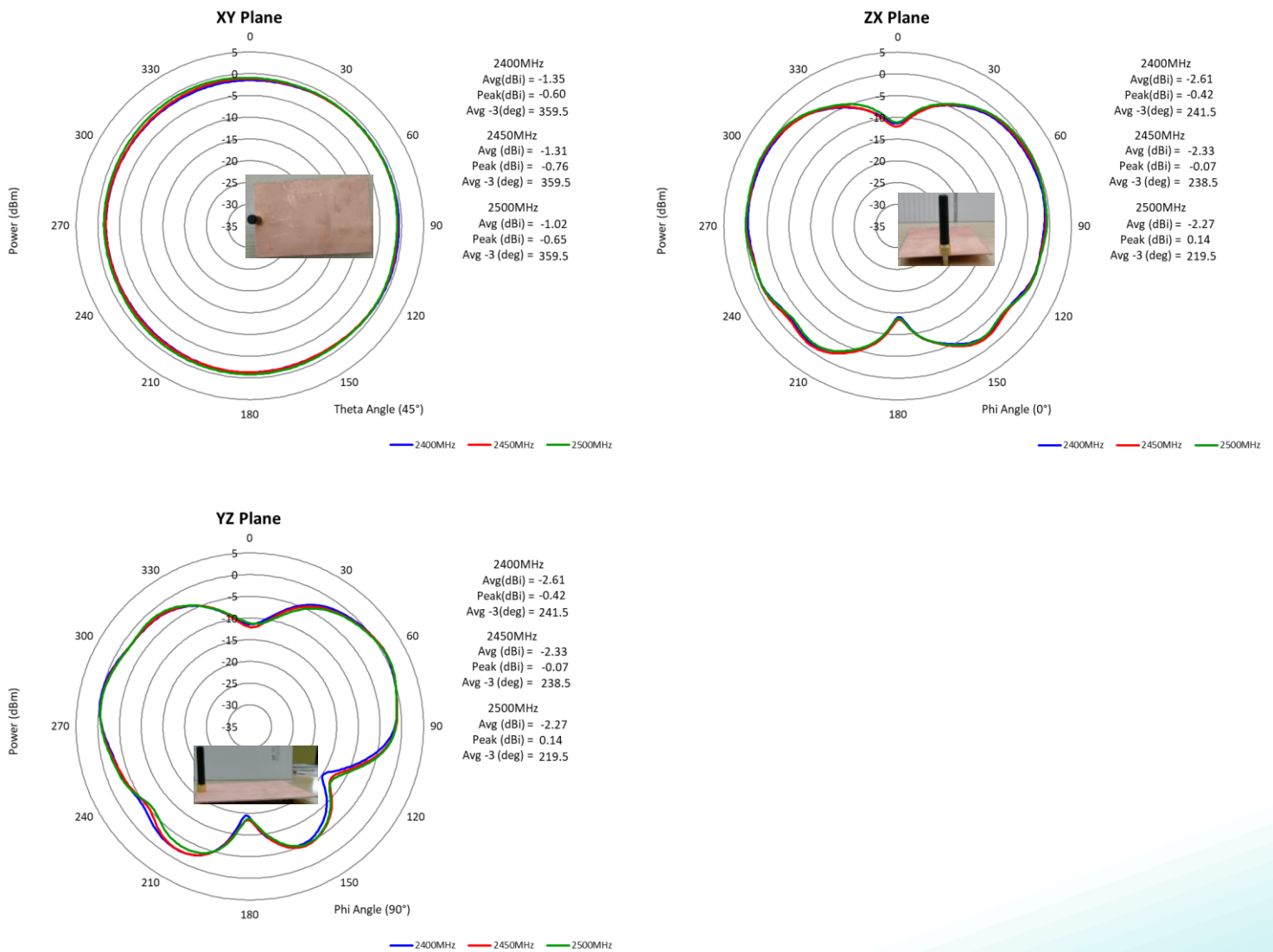

Issue: 1911

In the effort to improve our products, we reserve the right to make changes judged to be necessary.

CONFIDENTIAL AND PROPRIETARY INFORMATION

This document contains confidential and proprietary information of Pulse Electronics, Inc. (Pulse) and is protected by copyright, trade secret and other state and federal laws. Its receipt or possession does not convey any rights to reproduce, disclose its contents, or to manufacture, use or sell anything it may describe. Reproduction, disclosure or use without specific written authorization of Pulse is strictly forbidden.

Series: Stubby Antenna

Description:

Tri-Band 868/915/2400-2500MHz, Straight

PART NUMBER: W1698/W1699/W1698-M

PACKAGING

1pcs antenna per PE bag

24pcs PE bags per tray

14pcs trays per package box(2 pcs empty tray)

288pcs antenna per package

Package box: 460mm*235mm*140mm