

DATA SHEET

# SKY65337-11: 2.4 GHz Transmit/Receive Front-End Module

## Applications

- 2.4 GHz ISM band radios
- ZigBee® FEMs
- IEEE 802.15.4 applications

## Features

- Transmit output power > +20 dBm
- Bidirectional path NF < 2 dB
- High efficiency PA
- Programmable transmit power levels
- Configurable transmit/bidirectional paths
- Internal switching and control circuits
- Internal RF match and bias circuits
- Single DC supply = 3.0 V
- Interfaces seamlessly with Ember EM250 and EM260 ZigBee transceivers
- All RF ports are internally DC blocked
- Small footprint, MCM (28-pin, 8 x 8 mm) SMT package (MSL3, 260 °C per JEDEC J-STD-020)

## Description

Skyworks SKY65337-11 is a high-efficiency Front-End Module (FEM) for ZigBee and other 2.4 GHz ISM band applications. The small 8 x 8 mm Multi-Chip Module (MCM) contains a 2400-2500 MHz high-efficiency transmit path and a low-loss bidirectional path. The bidirectional path can be used to directly connect the antenna port to a directional RF port.

The transmit path consists of an harmonic filter and high efficiency Power Amplifier (PA) capable of providing +20 dBm of power at the antenna port. Also included is an internal balun to allow use of differential input signals.

The bidirectional path contains a high isolation transmit/receive (T/R) switch and balun for low-noise differential output. The bidirectional path can be used for either transmit or receive.

The differential output receiver port is bidirectional and can be used to operate the module in a low-power transmit mode.

The device is mounted in a 28-pin, 8 x 8 mm MCM Surface-Mounted Technology (SMT) package, which allows for a highly manufacturable low-cost solution.

A block diagram of the SKY65337-11 is shown in Figure 1. The device package and pinout for the 28-pin MCM are shown in Figure 2.



Skyworks Pb-free products are compliant with all applicable legislation. For additional information, refer to *Skyworks Definition of Lead (Pb)-Free*, document number SQ04-0073.

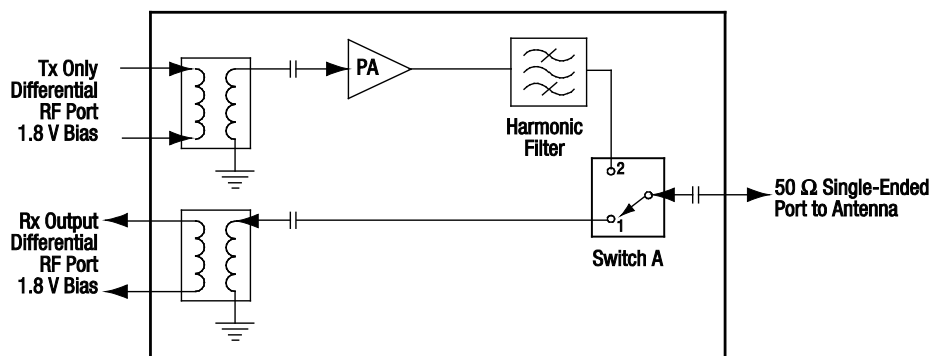

S1271

Figure 1. SKY65337-11 Block Diagram

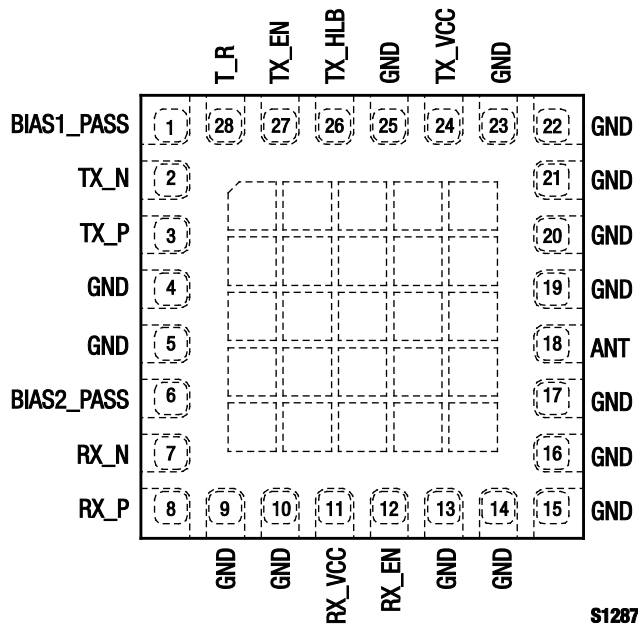

Figure 2. SKY65337-11 Pinout – 28-Pin MCM (Top View)

## Technical Description

### Transmit/Receive (T/R) Enable

Pin 27 (TX\_EN) and pin 12 (RX\_EN) are used to enable the transmit and receive port, respectively.

### T/R Switch

Pin 28 (T\_R) is used to control the T/R switch.

### T/R Enable and T/R Switch Mode Control

The following control logic is used to configure the transmit or receive mode of the SKY65337-11:

| TX_EN | RX_EN | T_R  | Mode          |
|-------|-------|------|---------------|
| High  | Low   | High | Transmit mode |
| Low   | High  | Low  | Receive mode  |

### High Power and Low Power Modes

High power mode output is 20 dBm and low power mode output is 10 dBm. Pin 26 (TX\_HLB) sets the transmit path in high power or low power mode according to the following logic:

| TX_HLB | State           |
|--------|-----------------|
| Low    | High power mode |
| High   | Low power mode  |

### Bottom Center Paddle

The bottom center paddles must be electrically grounded for proper RF performance. Customers should place adequate thermal vias under the ground paddles for optimum thermal performance. The Evaluation Board layout (see Figures 3 and 4) can be used as a guide for RF ground and thermal layout.

### Tx/ Rx Mode Control with limited Fast Control Lines

If only one fast analog control line is available for module configuration, users can connect the RX\_EN pin to 3 V, and connect the TX\_EN and T\_R control lines together as follows:

| TX_EN | T_R  | RX_EN | Module Configuration |
|-------|------|-------|----------------------|
| High  | High | High  | Transmit mode        |
| Low   | Low  | High  | Receive mode         |

## Electrical and Mechanical Specifications

Signal pin assignments and functional pin descriptions are described in Table 1. The absolute maximum ratings of the SKY65337-11 are provided in Table 2. The recommended operating conditions are specified in Table 3 and electrical specifications are provided in Table 4.

Typical performance characteristics of the SKY65337-11 are illustrated in Figures 3 through 12.

**Table 1. SKY65337-11 Signal Descriptions**

| Pin # | Name       | Description                  | Pin # | Name   | Description              |
|-------|------------|------------------------------|-------|--------|--------------------------|
| 1     | BIAS1_PASS | Transmit port bias supply    | 15    | GND    | Ground                   |
| 2     | TX_N       | Negative transmit input port | 16    | GND    | Ground                   |
| 3     | TX_P       | Positive transmit input port | 17    | GND    | Ground                   |
| 4     | GND        | Ground                       | 18    | ANT    | Antenna input            |
| 5     | GND        | Ground                       | 19    | GND    | Ground                   |
| 6     | BIAS2_PASS | Receive port bias supply     | 20    | GND    | Ground                   |
| 7     | RX_N       | Negative receive output port | 21    | GND    | Ground                   |
| 8     | RX_P       | Positive receive output port | 22    | GND    | Ground                   |
| 9     | GND        | Ground                       | 23    | GND    | Ground                   |
| 10    | GND        | Ground                       | 24    | TX_VCC | Transmit DC supply, +3 V |
| 11    | RX_VCC     | Receive DC supply, +3 V      | 25    | GND    | Ground                   |
| 12    | RX_EN      | Receive enable               | 26    | TX_HLB | Transmit power mode      |
| 13    | GND        | Ground                       | 27    | TX_EN  | Transmit enable          |
| 14    | GND        | Ground                       | 28    | T_R    | Transmit/receive switch  |

**Note:** The bottom ground pad must be connected to RF ground.

**Table 2. SKY65337-11 Absolute Maximum Ratings (Note 1)**

| Parameter                     | Symbol  | Minimum | Maximum | Units |
|-------------------------------|---|---------|---------|-------|
| Supply voltage                | RX_VCC, TX_VCC  | 2.1     | 4       | V     |
| Control Voltage               | BIAS1_PASS,<br>BIAS2_PASS, TX_EN,<br>RX_EN, TX_HLB, T_R |         | 3.6     | V     |
| Bypass voltage                | BIAS1_PASS,<br>BIAS2_PASS                               |         | 1.9     | V     |
| RF input power, antenna port  | P <sub>IN_ANT</sub>                                     |         | 2       | W     |
| RF input power, transmit port | P <sub>IN_TX</sub>                                      |         | +8      | dBm   |
| Case operating temperature    | T <sub>C</sub>  | -40     | +85     | °C    |
| Storage temperature           | T <sub>ST</sub>   | -55     | +125    | °C    |
| Junction temperature          | T <sub>J</sub>  |         | +150    | °C    |

**Note 1:** Exposure to maximum rating conditions for extended periods may reduce device reliability. There is no damage to device with only one parameter set at the limit and all other parameters set at or below their nominal value. Exceeding any of the limits listed here may result in permanent damage to the device.

**CAUTION:** Although this device is designed to be as robust as possible, Electrostatic Discharge (ESD) can damage this device. This device must be protected at all times from ESD. Static charges may easily produce potentials of several kilovolts on the human body or equipment, which can discharge without detection. Industry-standard ESD precautions should be used at all times.

**Table 3. SKY65337-11 Recommended Operating Conditions**

| Parameter                       | Symbol                    | Minimum | Typical | Maximum | Units |
|---------------------------------|---------------------------|---------|---------|---------|-------|
| Supply voltage (TX_VCC, RX_VCC) | VCC                       | 2.7     | 3.0     | 3.6     | V     |
| T/R bias supply voltage         | BIAS1_PASS,<br>BIAS2_PASS | 1.7     | 1.8     | 1.9     | V     |
| T/R enable voltage:             |                           |         |         |         |       |
| Low                             | TX_ENL, RX_ENL            |         | 0       | 0.1     | V     |
| High                            | TX_ENH, RX_ENH            | 1.62    | 1.80    | 3.60    | V     |
| T/R control voltage:            |                           |         |         |         |       |
| Low                             | T_RL, TX_HLB <sub>L</sub> |         | 0       | 0.1     | V     |
| High                            | T_RH, TX_HLB <sub>H</sub> | 1.62    | 1.80    | 3.60    | V     |
| Frequency range                 | f                         | 2400    |         | 2500    | MHz   |

**Table 4. SKY65337-11 Electrical Specifications (Note 1)**  
**(VCC = 3.0 V, Tc = 25 °C, Unless Otherwise Noted)**

| Parameter                              | Symbol             | Test Condition   | Min   | Typical | Max  | Units |
|--|--------------------|--|-------|---------|------|-------|
| Frequency range                        | f                  |  | 2400  |         | 2500 | MHz   |
| Return loss                            | RL                 | All RF ports   | 6     | 10      |      | dB    |
| <b>Transmitter Section</b>             |                    |  |       |         |      |       |
| Input power range                      | P <sub>IN</sub>    | CW   |       | +3      |      | dBm   |
| Transmit saturated output power        | P <sub>SAT_H</sub> | High power mode  | +19.5 | +20.1   |      | dBm   |
|  | P <sub>SAT_L</sub> | Low power mode   | +8.3  | +10.5   |      | dBm   |
| Operating current                      | I <sub>OP_H</sub>  | High power mode, total current                           |       | 145     | 150  | mA    |
|  | I <sub>OP_L</sub>  | Low power mode, total current                            |       | 72      | 80   | mA    |
| 2 <sup>nd</sup> harmonic (Note 2)      | P <sub>n2</sub>    | CW, P <sub>OUT</sub> = +20 dBm                           |       | -44     | -39  | dBm   |
| 3 <sup>rd</sup> harmonic (Note 2)      | P <sub>n3</sub>    | CW, P <sub>OUT</sub> = +20 dBm                           |       | -44     | -39  | dBm   |
| Saturated gain                         | G <sub>H</sub>     | CW, high power mode                                      |       | 17      |      | dB    |
|  | G <sub>L</sub>     | CW, low power mode                                       |       | 7       |      | dB    |
| Leakage current                        | I <sub>LEAK</sub>  | No RF input, VCC = 3.0 V,<br>RX_EN = 0 V,<br>TX_EN = 0 V |       | 0.5     |      | µA    |
| <b>Bidirectional (Receive) Section</b> |                    |  |       |         |      |       |
| Insertion loss                         | IL                 | CW   |       | 1.6     | 2.0  | dB    |
| Leakage current                        | I <sub>LEAK</sub>  | No RF input, VCC = 3.0 V,<br>RX_EN = 0 V,<br>TX_EN = 0 V |       | 0.5     |      | µA    |

**Note 1:** Performance is guaranteed only under the conditions listed in this Table.

**Note 2:** Harmonic levels using the Zigbee modulated signal are +6 dBm lower than the values shown here.

**Typical Performance Characteristics**  
 (VCC = 3.0 V, Tc = 25 °C, Unless Otherwise Noted)

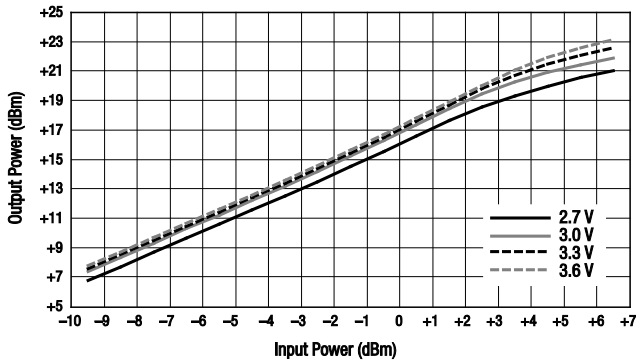

**Figure 3. High Power Mode, Output Power vs Input Power Over VCC @ 2450 MHz**

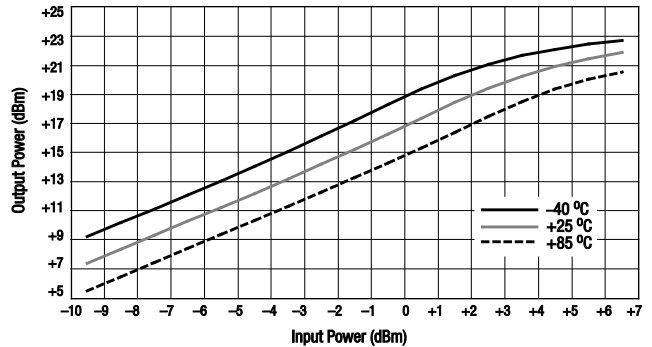

**Figure 4. High Power Mode, Output Power vs Input Power Over Temperature @ 2450 MHz**

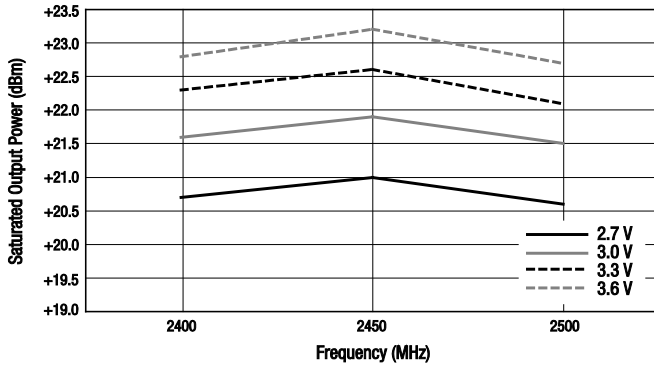

**Figure 5. High Power Mode, Saturated Output Power vs Frequency Over Voltage**

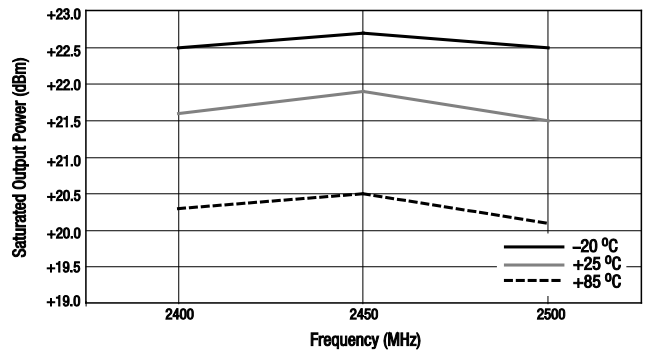

**Figure 6. High Power Mode, Saturated Output Power vs Frequency Over Temperature**

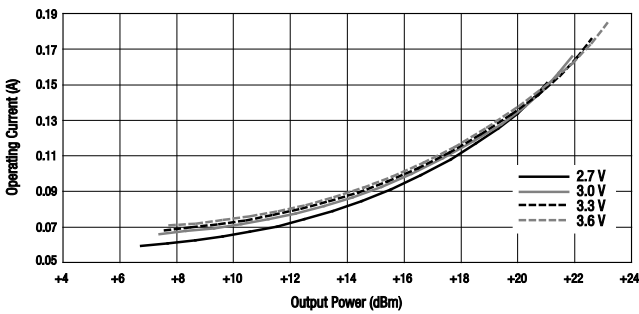

**Figure 7. High Power Mode Operating Current vs Output Power Over VCC @ 2450 MHz**

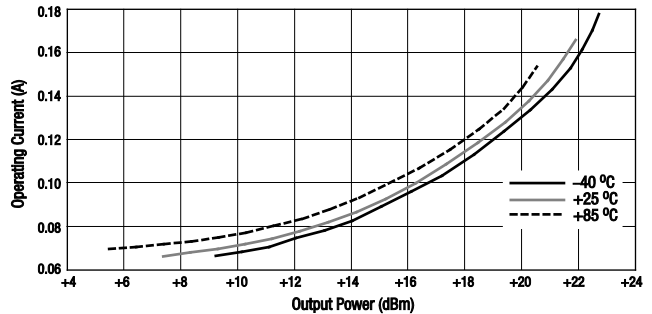

**Figure 8. High Power Mode, Operating Current vs Output Power Over Temperature @ 2450 MHz**

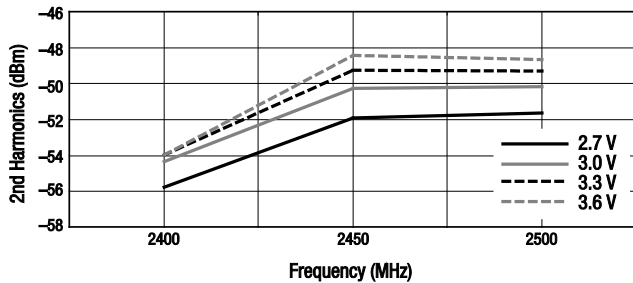

Figure 9. High Power Mode, 2<sup>nd</sup> Harmonics vs Frequency Over VCC

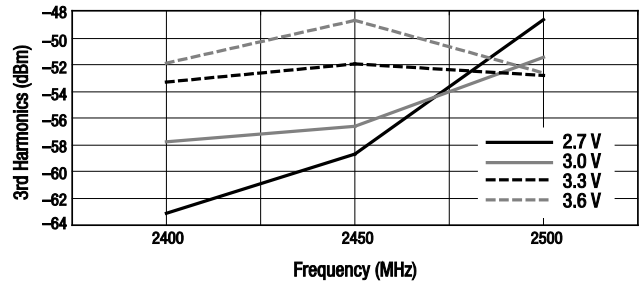

Figure 10. High Power Mode, 3<sup>rd</sup> Harmonics vs Frequency Over VCC

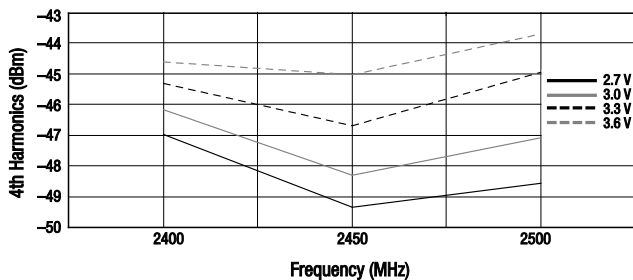

Figure 11. High Power Mode, 4<sup>th</sup> Harmonics vs Frequency Over VCC

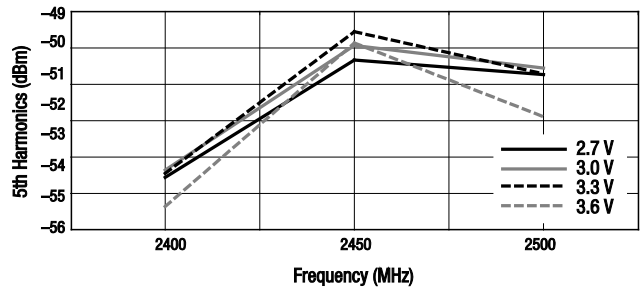

Figure 12. High Power Mode, 5<sup>th</sup> Harmonics vs Frequency Over VCC

### Evaluation Board Description

The SKY65337-11 Evaluation Board is used to test the performance of the SKY65337-11 FEM. The Evaluation Board schematic diagram is shown in Figure 13. An assembly drawing for the Evaluation Board is shown in Figure 14.

### Package Dimensions

The phone board layout footprint for the SKY65337-11 is shown in Figure 15. Package dimensions for the 28-pin MCM are shown in Figure 16, and tape and reel dimensions are provided in Figure 17.

### Package and Handling Information

Since the device package is sensitive to moisture absorption, it is baked and vacuum packed before shipping. Instructions on the

shipping container label regarding exposure to moisture after the container seal is broken must be followed. Otherwise, problems related to moisture absorption may occur when the part is subjected to high temperature during solder assembly.

The SKY65337-11 is rated to Moisture Sensitivity Level 3 (MSL3) at 260 °C. It can be used for lead or lead-free soldering. For additional information, refer to Skyworks Application Note, *PCB Design and SMT Assembly/Rework Guidelines for MCM-L Packages*, document number 101752.

Care must be taken when attaching this product, whether it is done manually or in a production solder reflow environment. Production quantities of this product are shipped in a standard tape and reel format.

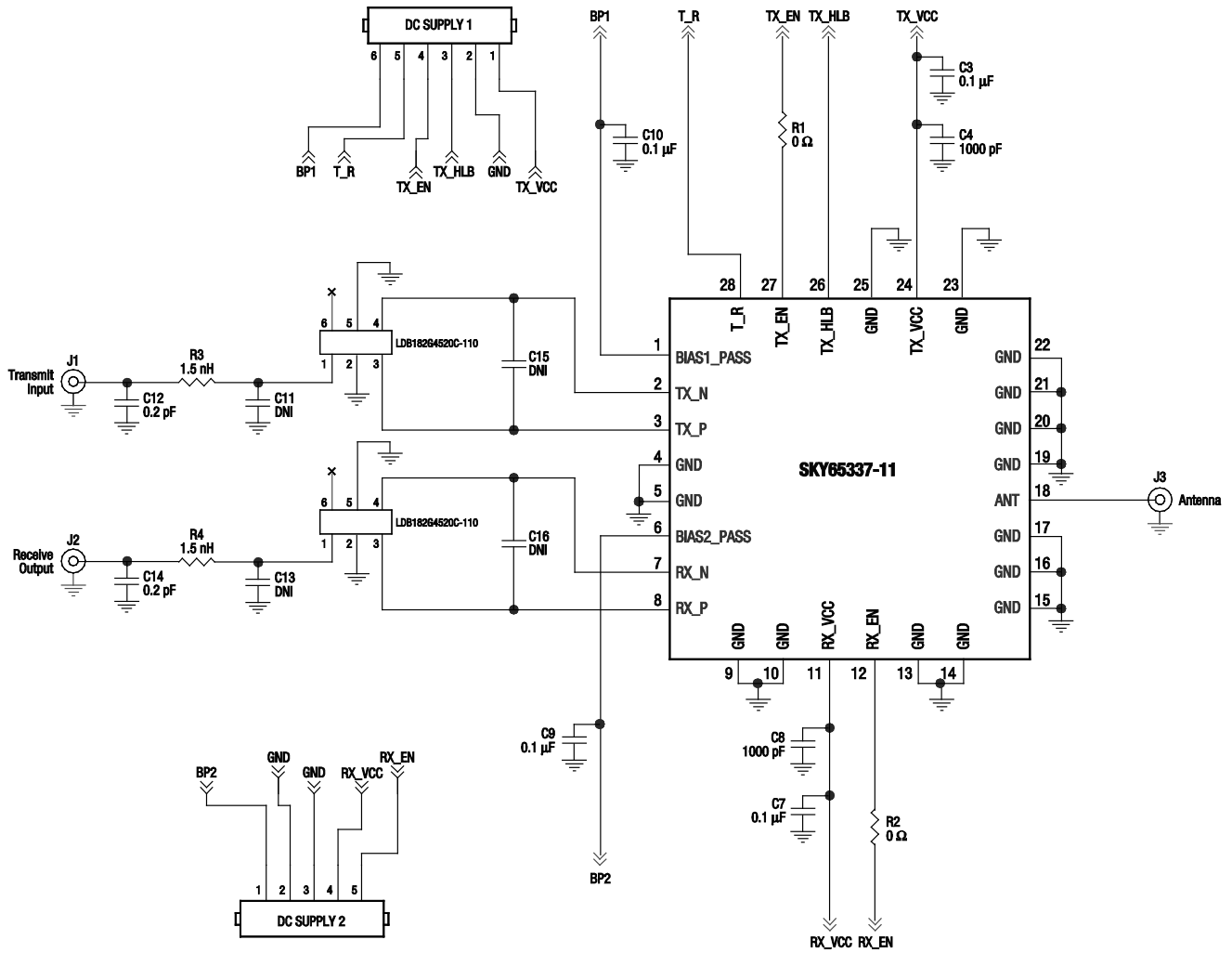

Note: Some component labels may be different than the corresponding component symbol shown here. Component values, however, are accurate as of the date of this Data Sheet.

S1288

Figure 13. SKY65337-11 Evaluation Board Schematic

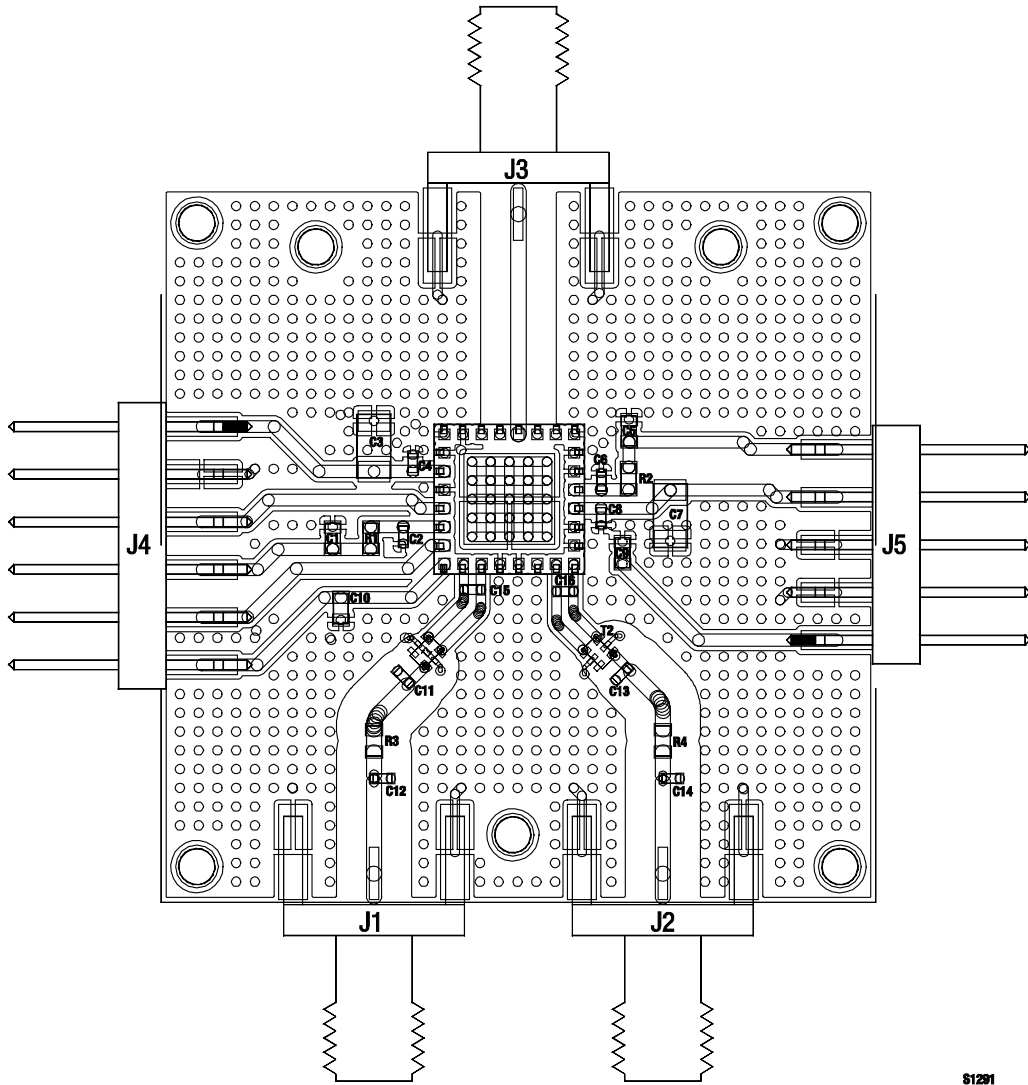
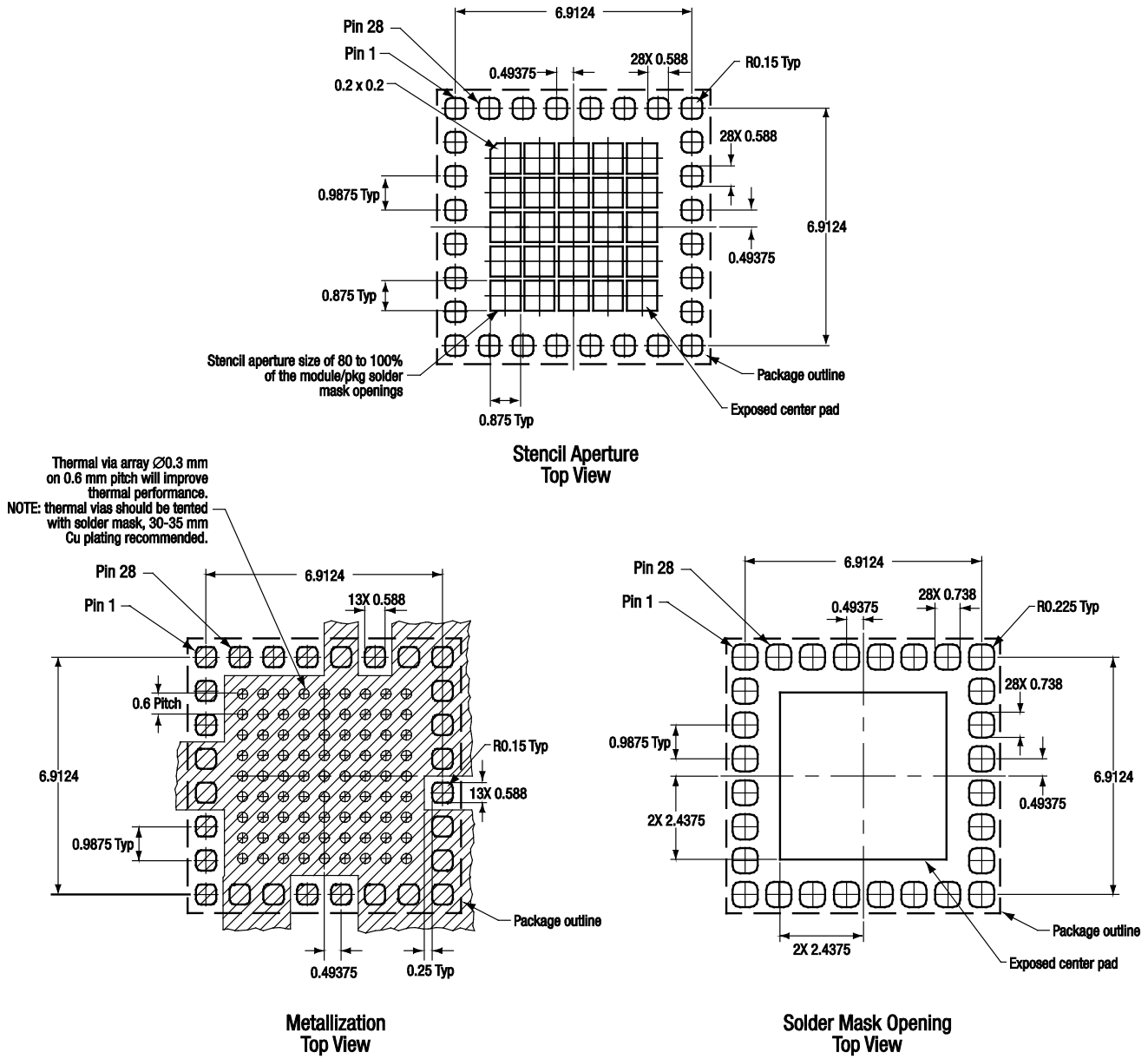

Figure 14. SKY65337-11 Evaluation Board Assembly Drawing

81291





All measurements are in millimeters

S1330

Figure 15. SKY65337-11 Phone Board Layout Footprint

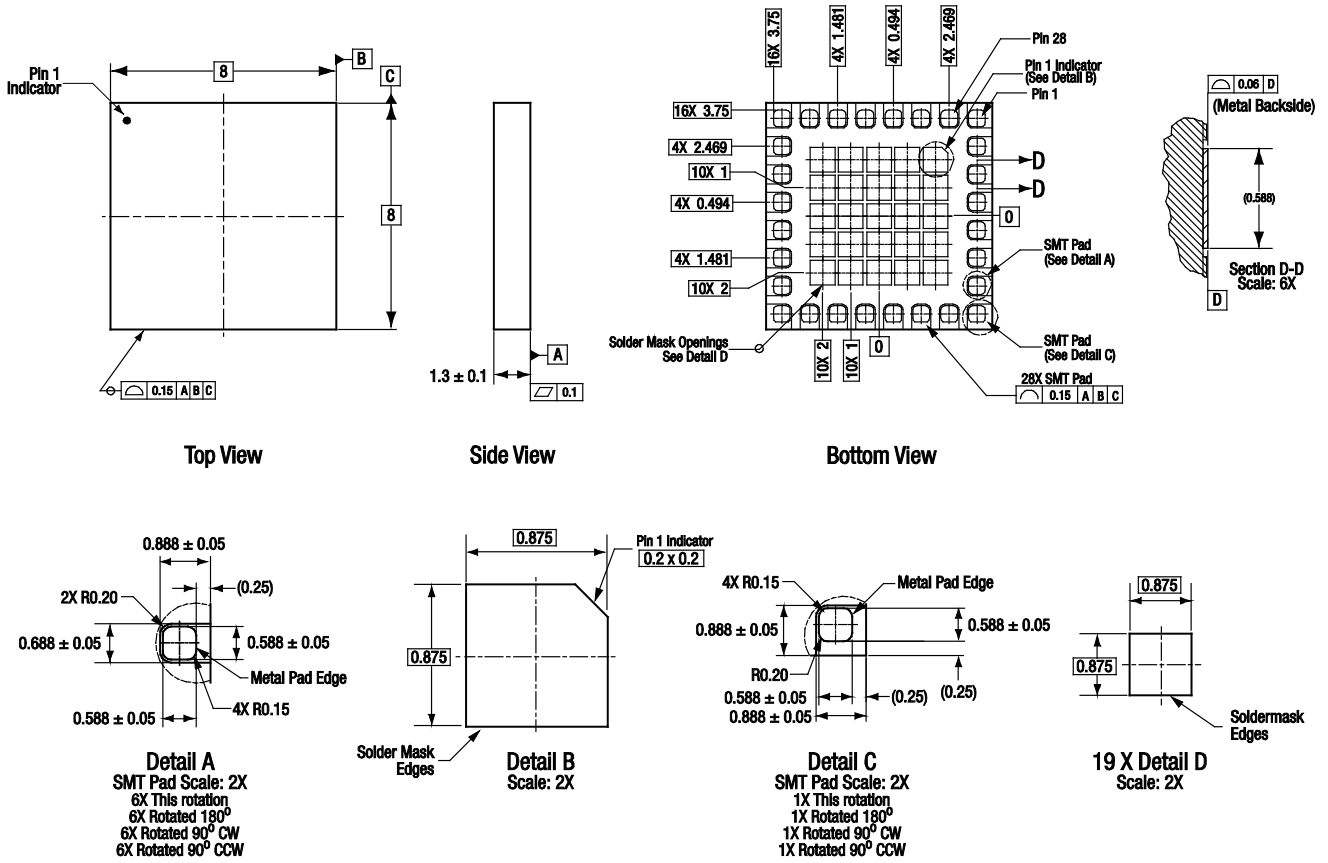

All measurements are in millimeters.  
 Dimensioning and tolerancing according to ASME Y14.5M-1994.  
 Pads are metal defined.

S2649

Figure 16. SKY65337-11 28-Pin MCM Package Dimensions

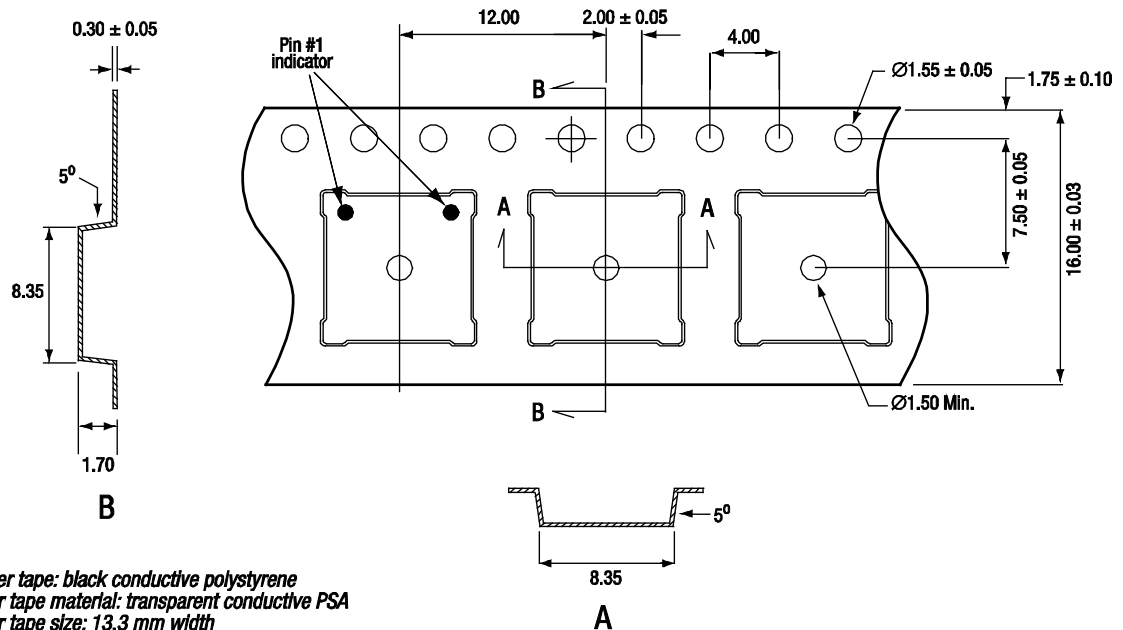

**Notes:**

1. Carrier tape: black conductive polystyrene
2. Cover tape material: transparent conductive PSA
3. Cover tape size: 13.3 mm width
4. All dimensions are in millimeters
5. Pin 1 orientation is in top left corner for the following Skyworks products:

SKY74963-xx  
 CX74063-35  
 SKY77503-xx  
 SKY77506-xx  
 SKY77512-xx  
 SKY77526-xx  
 SKY77343-xx

For all other 8 x 8 mm MCM/RFLGA products, pin 1 orientation is in top right corner.

S1290

**Figure 17. SKY65337-11 28-Pin MCM Tape and Reel Dimensions**

**Ordering Information**

| Model Name          | Manufacturing Part Number | Evaluation Board Part Number |
|---------------------|---------------------------|------------------------------|
| SKY65337-11 T/R FEM | SKY65337-11               | TW17-D475-001                |

Copyright © 2008, 2009, 2011 Skyworks Solutions, Inc. All Rights Reserved.

Information in this document is provided in connection with Skyworks Solutions, Inc. ("Skyworks") products or services. These materials, including the information contained herein, are provided by Skyworks as a service to its customers and may be used for informational purposes only by the customer. Skyworks assumes no responsibility for errors or omissions in these materials or the information contained herein. Skyworks may change its documentation, products, services, specifications or product descriptions at any time, without notice. Skyworks makes no commitment to update the materials or information and shall have no responsibility whatsoever for conflicts, incompatibilities, or other difficulties arising from any future changes.

No license, whether express, implied, by estoppel or otherwise, is granted to any intellectual property rights by this document. Skyworks assumes no liability for any materials, products or information provided hereunder, including the sale, distribution, reproduction or use of Skyworks products, information or materials, except as may be provided in Skyworks Terms and Conditions of Sale.

THE MATERIALS, PRODUCTS AND INFORMATION ARE PROVIDED "AS IS" WITHOUT WARRANTY OF ANY KIND, WHETHER EXPRESS, IMPLIED, STATUTORY, OR OTHERWISE, INCLUDING FITNESS FOR A PARTICULAR PURPOSE OR USE, MERCHANTABILITY, PERFORMANCE, QUALITY OR NON-INFRINGEMENT OF ANY INTELLECTUAL PROPERTY RIGHT; ALL SUCH WARRANTIES ARE HEREBY EXPRESSLY DISCLAIMED. SKYWORKS DOES NOT WARRANT THE ACCURACY OR COMPLETENESS OF THE INFORMATION, TEXT, GRAPHICS OR OTHER ITEMS CONTAINED WITHIN THESE MATERIALS. SKYWORKS SHALL NOT BE LIABLE FOR ANY DAMAGES, INCLUDING BUT NOT LIMITED TO ANY SPECIAL, INDIRECT, INCIDENTAL, STATUTORY, OR CONSEQUENTIAL DAMAGES, INCLUDING WITHOUT LIMITATION, LOST REVENUES OR LOST PROFITS THAT MAY RESULT FROM THE USE OF THE MATERIALS OR INFORMATION, WHETHER OR NOT THE RECIPIENT OF MATERIALS HAS BEEN ADVISED OF THE POSSIBILITY OF SUCH DAMAGE.

Skyworks products are not intended for use in medical, lifesaving or life-sustaining applications, or other equipment in which the failure of the Skyworks products could lead to personal injury, death, physical or environmental damage. Skyworks customers using or selling Skyworks products for use in such applications do so at their own risk and agree to fully indemnify Skyworks for any damages resulting from such improper use or sale.

Customers are responsible for their products and applications using Skyworks products, which may deviate from published specifications as a result of design defects, errors, or operation of products outside of published parameters or design specifications. Customers should include design and operating safeguards to minimize these and other risks. Skyworks assumes no liability for applications assistance, customer product design, or damage to any equipment resulting from the use of Skyworks products outside of stated published specifications or parameters.

Skyworks, the Skyworks symbol, and "Breakthrough Simplicity" are trademarks or registered trademarks of Skyworks Solutions, Inc., in the United States and other countries. Third-party brands and names are for identification purposes only, and are the property of their respective owners. Additional information, including relevant terms and conditions, posted at [www.skyworksinc.com](http://www.skyworksinc.com), are incorporated by reference.