

AS1344

42V, DC-DC Boost Converter with adjustable Softstart

1 General Description

The AS1344 boost converter contains a 1.4A internal switch in a tiny TDFN-10 3x3mm package. The device operates from a 0.9V to 3.6V supply, and can boost voltages up to 42V output.

The output voltage can easily be adjusted by an external resistor divider.

The AS1344 uses a unique control scheme providing the highest efficiency over a wide range of load conditions. An internal 1.4A MOSFET reduces external component count, and a fixed high switching frequency (1MHz) allows for tiny surface-mount components.

The AS1344 also features power-OK circuitry which monitors the output voltage.

The device also offers a Softstart function which limits the current during startup. The current during startup can be easily adjusted with the value of R_v . For $R_v = 0\Omega$, there is no softstart.

Additionally the AS1344 features a low quiescent supply current and a shutdown mode to save power. During shutdown an output disconnect switch separates the input from the output.

The AS1344 is ideal for LCD or OLED panels with low current requirements and can also be used in a wide range of other applications.

The device is available in a low-profile TDFN-10 3x3mm package.

2 Key Features

- 5.5V to 42V Adjustable Output Voltage
- 0.9V to 3.6V Supply Voltage Range
- High Output Current:
 - 30mA @ 12V V_{OUT} , from 1.5V V_{CC}
- Efficiency: Up to 85%
- Switching Frequency: 1MHz
- Output Disconnect Function
- Softstart Function with adjustable Current Limit
- Output Discharge Function
- Power-OK Output
- Quiescent Current: 22 μ A
- Shutdown Current: 0.1 μ A
- TDFN-10 3x3mm Package

3 Applications

The device is ideal for OLED display power supply, LCD bias generators, mobile/cordless phones, palmtop computers, PDAs and organizers, handy terminals, driving LEDs or any other portable, battery-powered device.

Figure 1. AS1344 - Typical Application Diagram

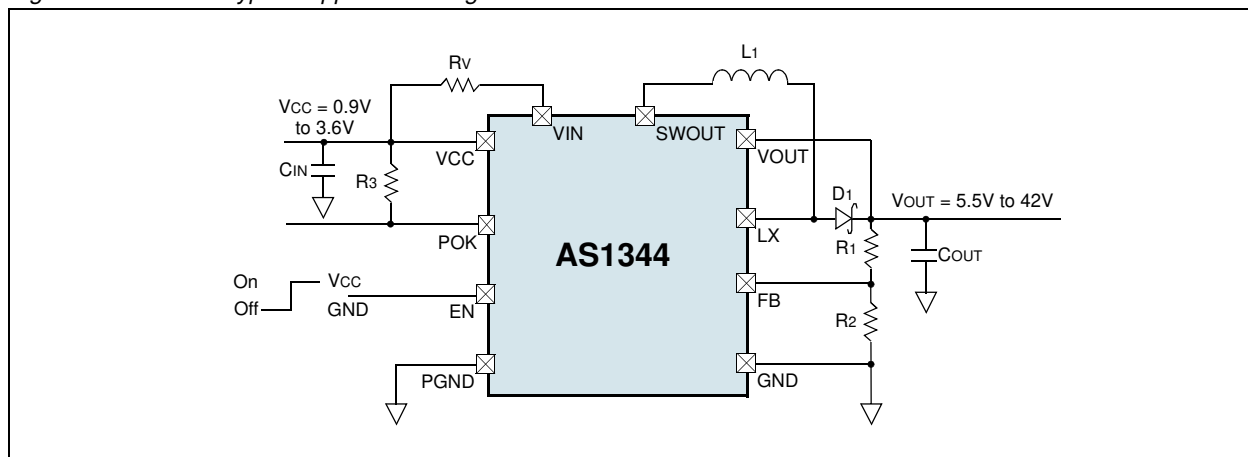

4 Pinout

Pin Assignments

Figure 2. Pin Assignments (Top View)

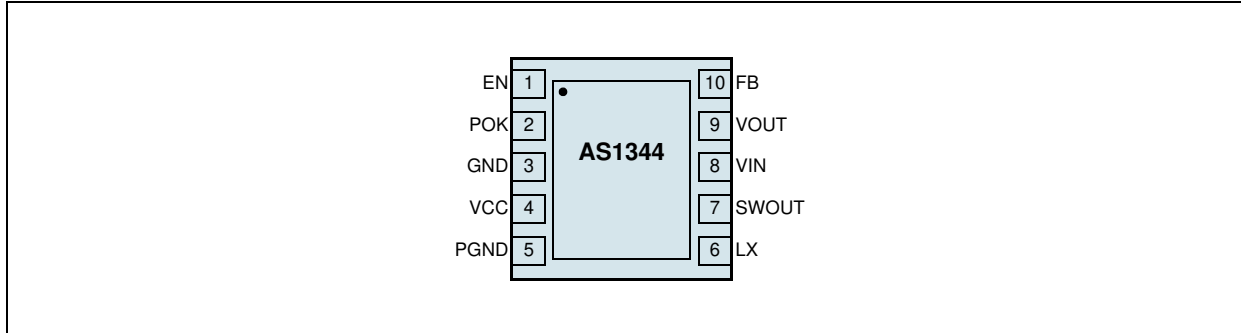

Pin Descriptions

Table 1. Pin Descriptions

Pin Number	Pin Name	Description
1	EN	Active-High Enable Input. A logic low on this pin shuts down the device and reduces the supply current to 0.1µA. GND: device in shutdown. Vcc : normal operation.
2	POK	Power-OK. 0: VOUT < 90% of VOUTNOM. 1: VOUT > 90% of VOUTNOM.
3	GND	Ground
4	VCC	+0.9V to +3.6V Supply Voltage. Bypass this pin to GND with a ≥10µF capacitor.
5	PGND	Ground. Should be the starpoint of CIN and COUT.
6	LX	Inductor. The drain of the internal N-channel MOSFET. Note: This pin is high impedance in shutdown.
7	SWOUT	Shutdown Disconnect Switch Out. Disconnects the input from the output during shutdown.
8	VIN	Supply Connection. Connect a resistor between pin VIN and pin VCC for limiting the input current during startup.
9	VOUT	+5.5 to +42V Output Voltage. This pin also powers the AS1344 after startup. Bypass this pin to GND with a ≥4.7µF capacitor.
10	FB	Feedback Pin. Feedback input to the gm error amplifier. Connect a resistor divider tap to this pin. The output voltage can be adjusted from 5.5V to 42V by: $V_{OUT} = 1.25V[1 + (R_1/R_2)]$

5 Absolute Maximum Ratings

Stresses beyond those listed in [Table 2](#) may cause permanent damage to the device. These are stress ratings only, and functional operation of the device at these or any other conditions beyond those indicated in [Electrical Characteristics on page 4](#) is not implied. Exposure to absolute maximum rating conditions for extended periods may affect device reliability.

Table 2. Absolute Maximum Ratings

Parameter	Min	Max	Units	Comments
VCC, VIN, EN, SWOUT, POK, FB to GND		5	V	
VOUT, LX to GND		45		
Thermal Resistance Θ_{JA}	36.7		$^{\circ}\text{C}/\text{W}$	on PCB
ESD	2		kV	<i>HBM MIL-Std. 883E 3015.7 methods</i>
Latch-Up	-200	+100	mA	<i>@25°C, JEDEC 78</i>
Operating Temperature Range	-40	+85	$^{\circ}\text{C}$	
Storage Temperature Range	-65	+150	$^{\circ}\text{C}$	
Junction Temperature		125	$^{\circ}\text{C}$	
Package Body Temperature		+260	$^{\circ}\text{C}$	The reflow peak soldering temperature (body temperature) specified is in accordance with <i>IPC/JEDEC J-STD-020D "Moisture/Reflow Sensitivity Classification for Non-Hermetic Solid State Surface Mount Devices"</i> . The lead finish for Pb-free leaded packages is matte tin (100% Sn).

6 Electrical Characteristics

$V_{CC} = EN = 3.6V$, $T_{AMB} = -40$ to $+85^{\circ}C$ (unless otherwise specified). Typ values are at $T_{AMB} = +25^{\circ}C$.

Table 3. Electrical Characteristics

Symbol	Parameter	Condition	Min	Typ	Max	Unit
V _{CC}	Maximum Supply Voltage				3.6	V
	Minimum Supply Voltage	V _{OUT} = 12V, R _V = 0Ω, no load		0.9	1.1	V
	Minimum Start-Up Voltage	V _{OUT} = 12V, I _{LOAD} = 1mA, R _V = 0Ω		0.95	1.2	V
V _{OUT}	Output Voltage Range		5.5		42	V
I _Q	Quiescent Current	V _{OUT} = 6V, V _{FB} = 1.3V		22	30	μA
I _{SHDN}	Shutdown Current	EN = GND, T _{AMB} = +25°C		0.02	1	μA
ΔV _{LNR}	V _{CC} Line Regulation	V _{OUT} = 15V, I _{LOAD} = 1mA, V _{CC} = 1.8 to 3.6V		0.05		%/V
ΔV _{LDR}	Load Regulation	V _{OUT} = 15V, I _{LOAD} = 0 to 20mA		0.01		%/mA
η	Efficiency	L ₁ = 6.8μH, V _{OUT} = 12V, I _{LOAD} = 50mA		85		%
V _{FB}	Feedback Voltage		1.225	1.25	1.275	V
I _{FB}	Feedback Input Bias Current	V _{FB} = 1.3V		1	100	nA
DC-DC Switches						
R _{LX}	NMOS Switch On-Resistance	I _{LX} = 100mA		0.9	1.5	Ω
R _{P_ON}	PMOS Switch On-Resistance	I _{SWout} = -100mA		0.3	1.0	
I _{LX_LEAK}	LX Leakage Current	V _{LX} = 42V		15		nA
I _{P_LEAK}	Switch Leakage Current	P-channel		10		
Control Inputs						
V _{IH}	EN Input Threshold	1.1V ≤ V _{CC} ≤ 3.6V	0.7 x V _{CC}			V
V _{IL}					0.3 x V _{CC}	
V _{EN}	EN Input Voltage		0		3.6	V
I _{EN}	EN Input Current	V _{EN} = 0 to 3.6V		1		nA
POK Output						
V _{OL}	POK Output Low Voltage	POK sinking 1mA		0.01	0.2	V
	POK Output High Leakage Current	POK = 3.6V		1	500	nA
	POK Threshold	Falling edge, referenced to V _{OUT(NOM)}	87	90	93	%
Oscillator						
f _{CLK}	Oscillator Frequency		0.85	1	1.15	MHz
	Maximum Duty Cycle		90	95		%

7 Typical Operating Characteristics

Parts used for measurements: 6.8 μ H (MOS6020-682) Inductor, 10 μ F (GRM21BR60J106KE19) C_{IN} and 4.7 μ F (GRM32ER71H475KA88) C_{OUT}, (PMEG4010BEA) D₁;

Figure 3. Efficiency vs. Output Current; V_{OUT} = 6V

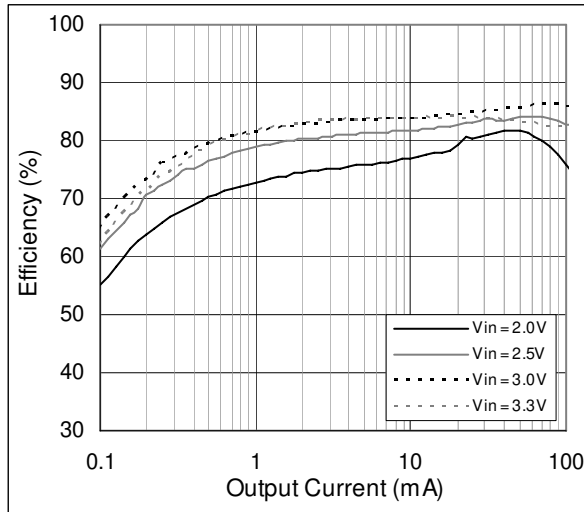

Figure 4. Efficiency vs. Output Current; V_{OUT} = 12V

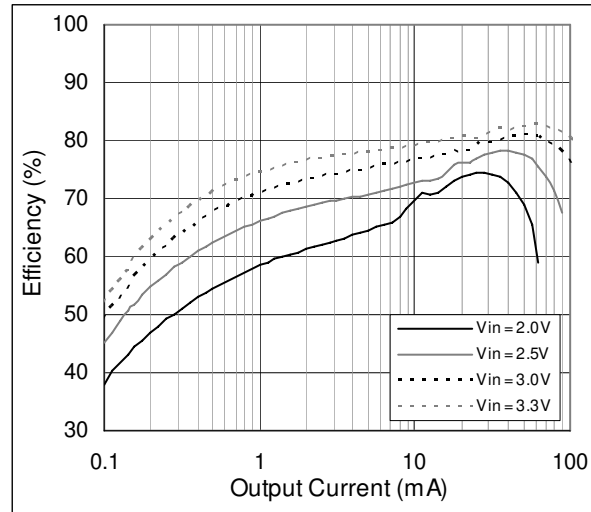

Figure 5. Efficiency vs. Output Current; V_{OUT} = 18V

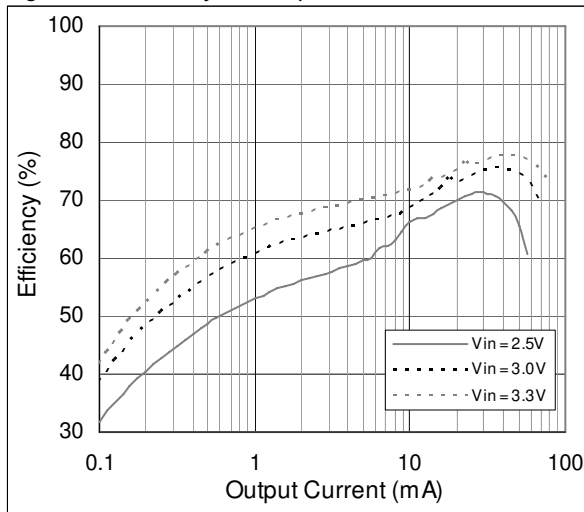

Figure 6. Efficiency vs. Output Current; V_{OUT} = 24V

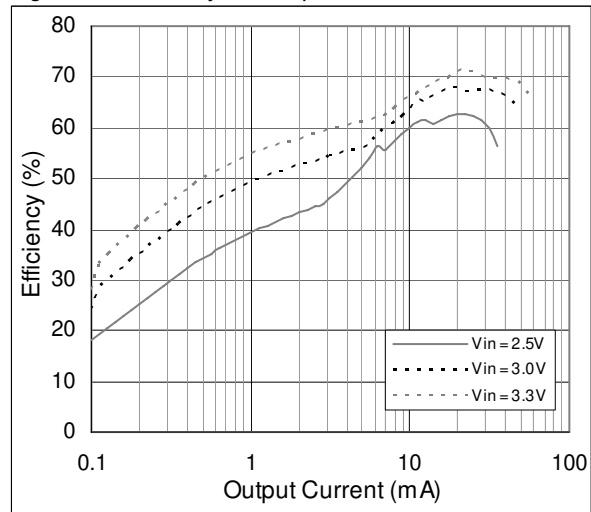

Figure 7. Efficiency vs. Input Voltage; V_{OUT} = 12V

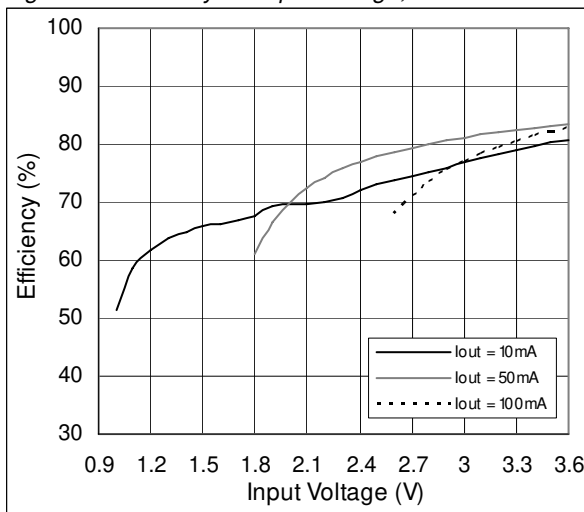

Figure 8. Efficiency vs. Input Voltage; I_{OUT} = 10mA

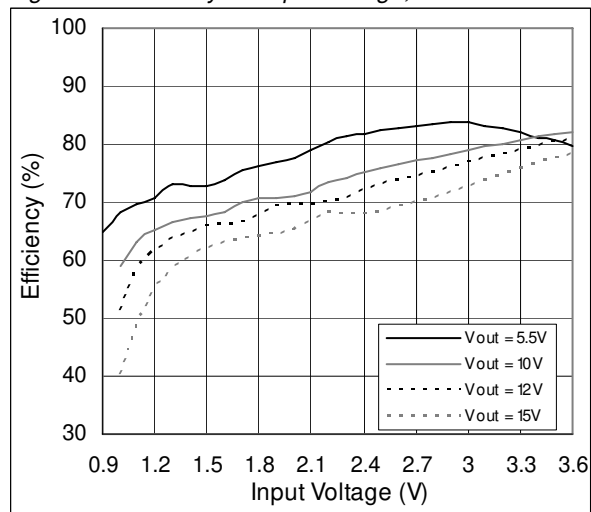

Figure 9. Output Voltage vs. Temperature; $V_{OUT}=18V$

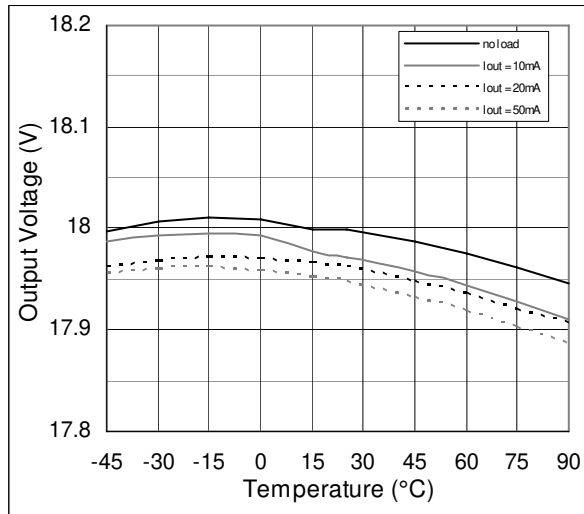

Figure 10. Output voltage vs. Input Voltage; $V_{OUT}=12V$, (line regulation)

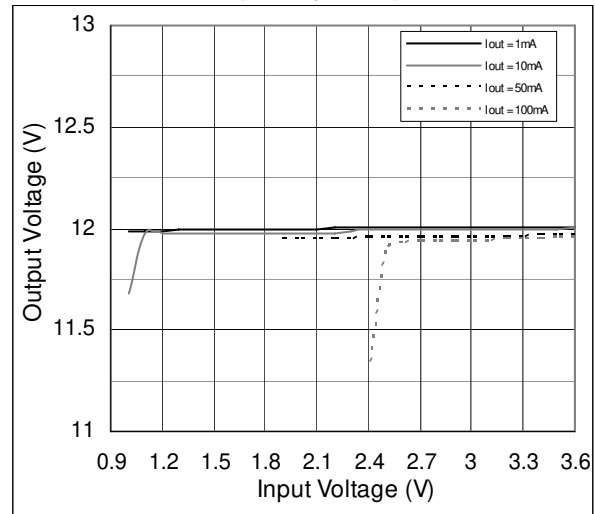

Figure 11. Output Voltage vs. Load Current; $V_{OUT}=12V$, $V_{IN}=1.5V$, (load regulation)

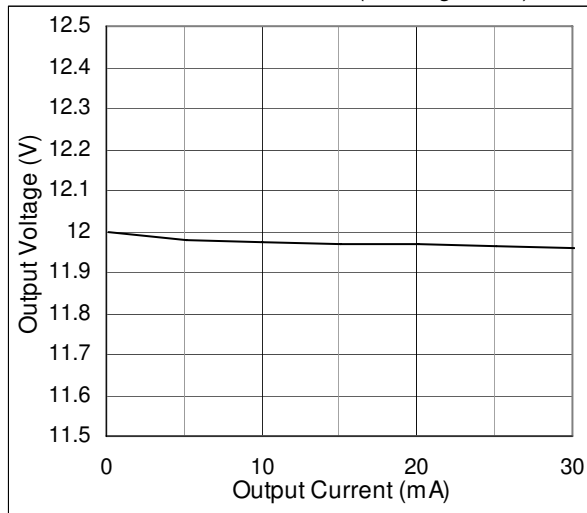

Figure 12. Maximum Output current vs. Input Voltage; $V_{OUT} = 12, 15, 18, 24, 36V$; (90% V_{outnom})

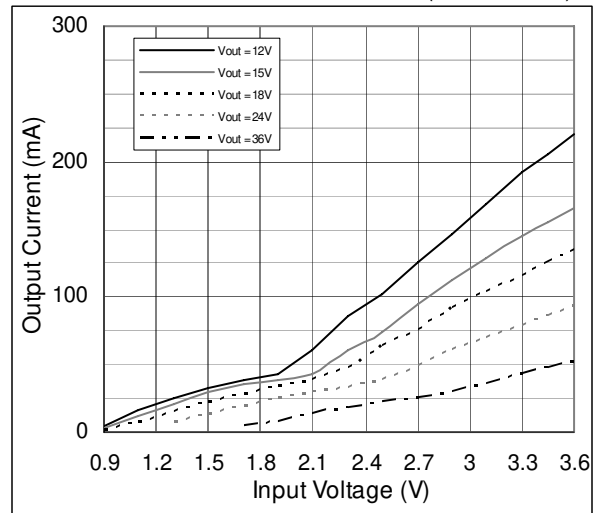

Figure 13. Maximum Output current vs. V_{OUT} ; $V_{CC} = 1.5V, 3V$

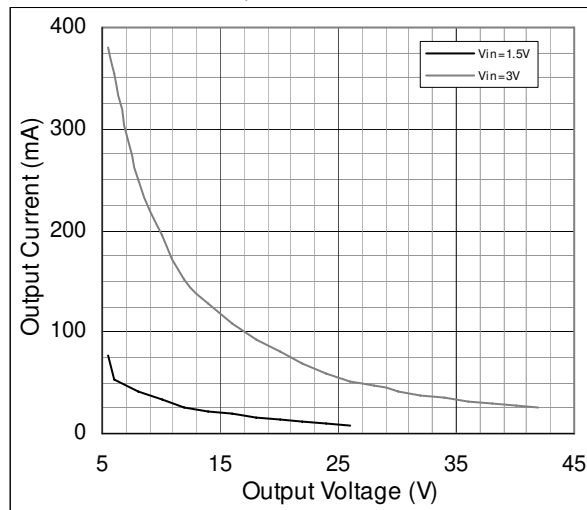

Figure 14. Start-Up Voltage vs. Output Current; $V_{CC} = 0.9V$ to $3.6V$, (95% V_{outnom})

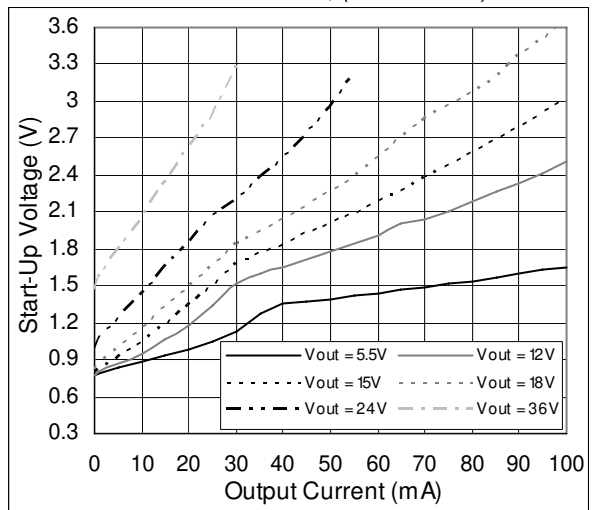

Figure 15. Shutdown Current vs. Input Voltage

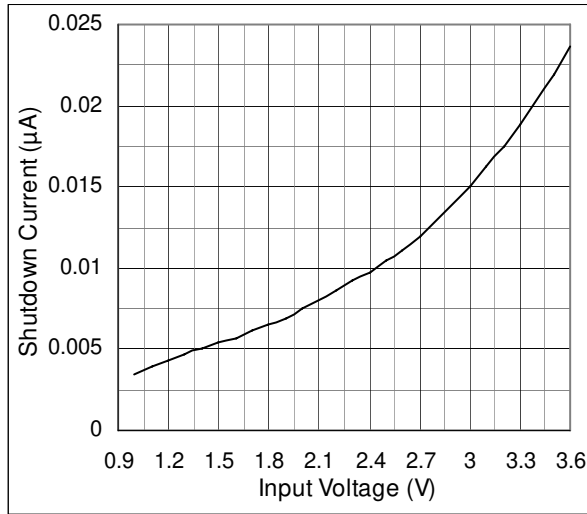

Figure 16. Shutdown Current vs. Temperature

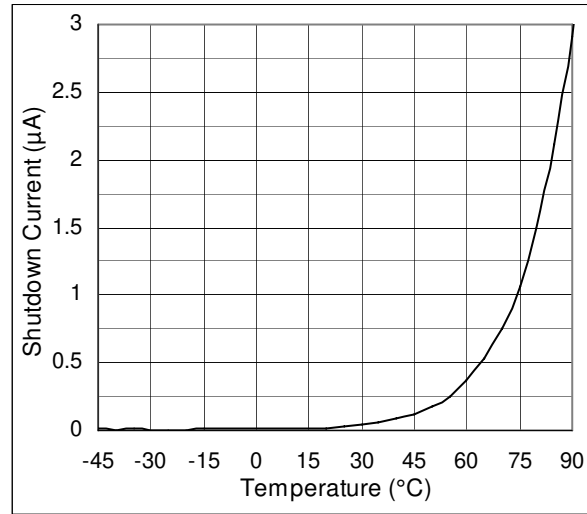

Figure 17. Switching Frequency vs. Temperature

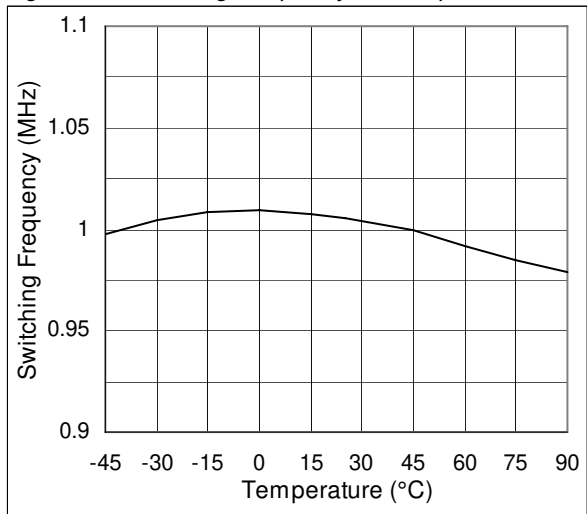

Figure 18. Feedback Voltage vs. Temperature

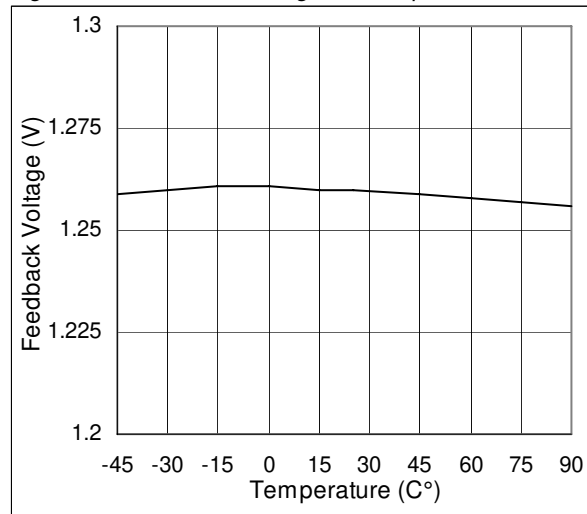

Figure 19. Quiescent Current vs. Input Voltage

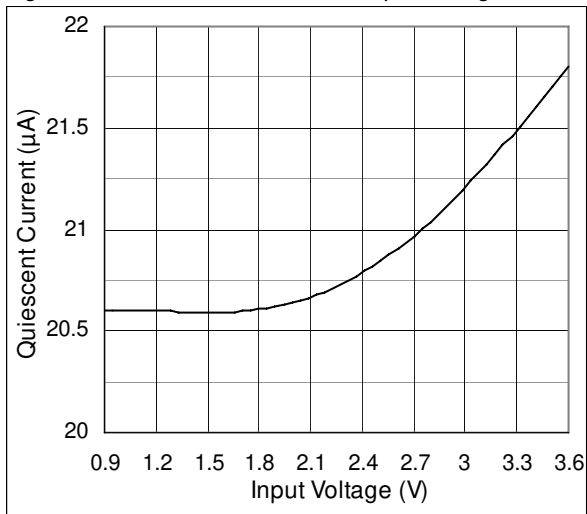

Figure 20. Startup Waveform; $V_{IN} = 1.8V$,
 $C_{OUT} = 170\mu F$, $R_V = 3\Omega$

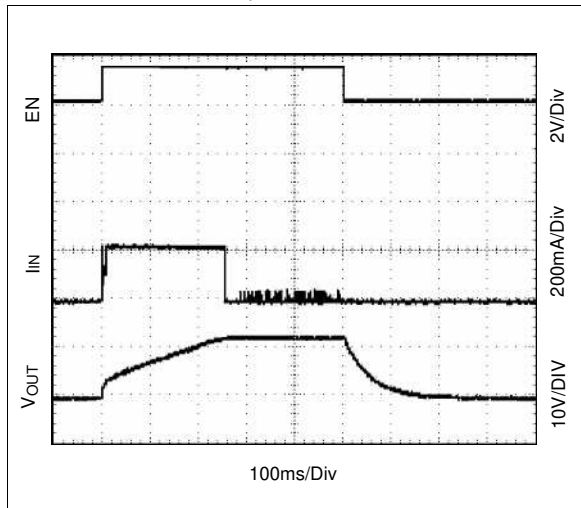

Figure 21. Startup Waveform, detail; $V_{IN} = 1.8V$,
 $C_{OUT} = 170\mu F$, $R_V = 3\Omega$

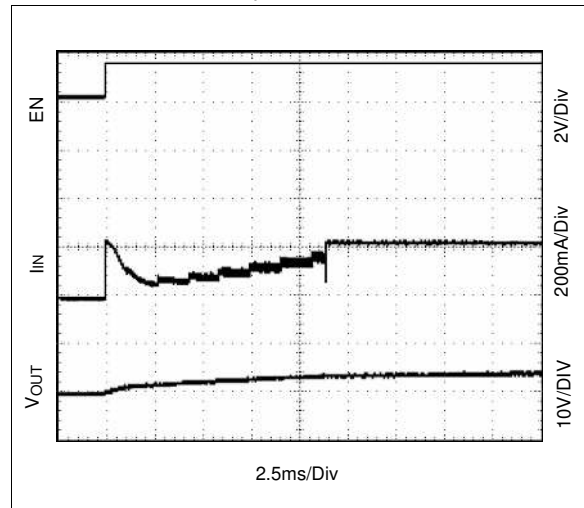

Figure 22. Startup Waveform; $V_{IN} = 2.4V$,
 $C_{OUT} = 170\mu F$, $R_V = 3\Omega$

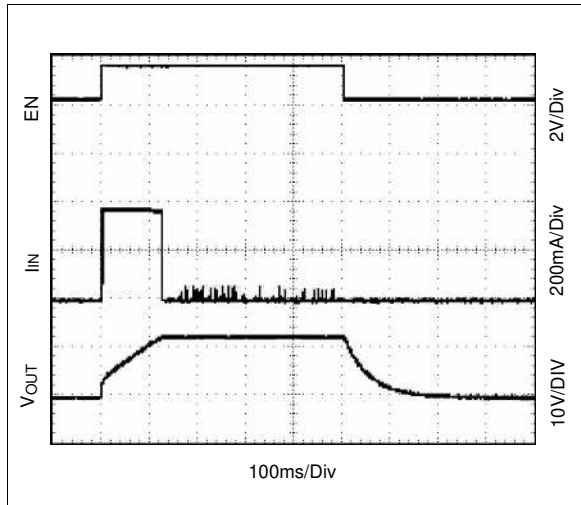

Figure 23. Startup Waveform, detail; $V_{IN} = 2.4V$,
 $C_{OUT} = 170\mu F$, $R_V = 3\Omega$

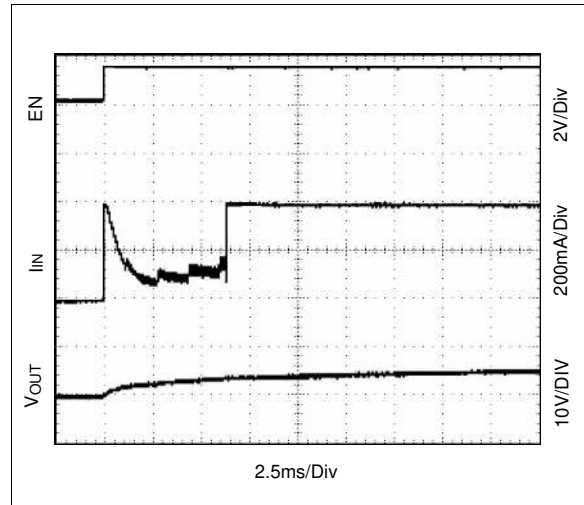

Figure 24. Startup Waveform; $V_{IN} = 3.0V$,
 $C_{OUT} = 170\mu F$, $R_V = 3\Omega$

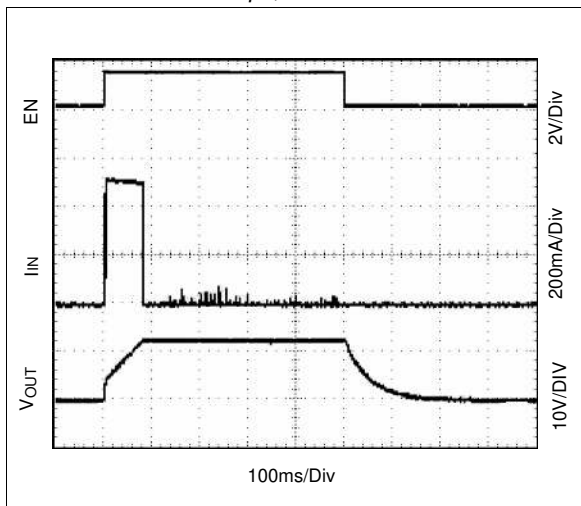

Figure 25. Startup Waveform, detail; $V_{IN} = 3.0V$,
 $C_{OUT} = 170\mu F$, $R_V = 3\Omega$

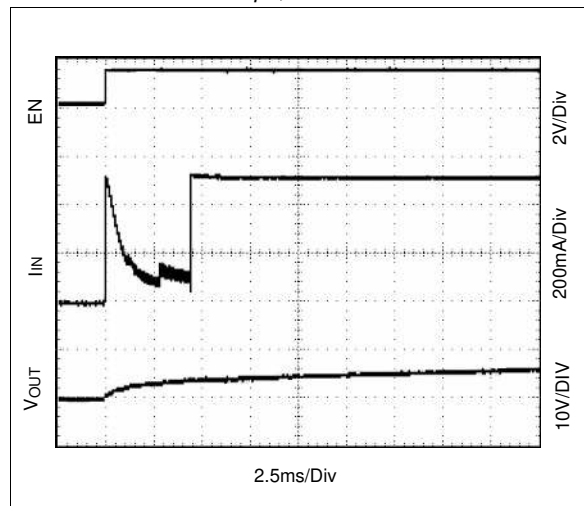

Figure 26. Transient Line Regulation;
 $V_{OUT} = 18V$, $I_{LOAD} = 1mA$

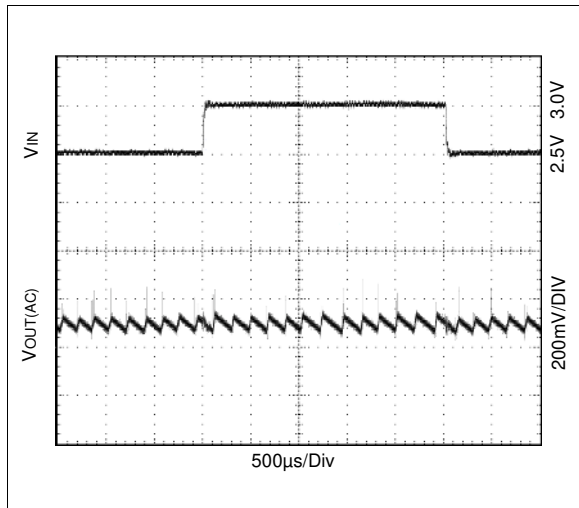

Figure 27. Transient Line Regulation;
 $V_{OUT} = 18V$, $I_{LOAD} = 20mA$

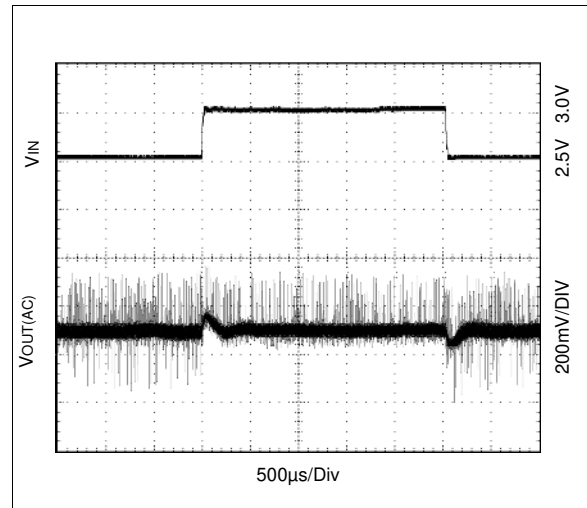

Figure 28. Output Voltage Ripple;
 $V_{OUT} = 18V$, $I_{OUT} = 1mA$

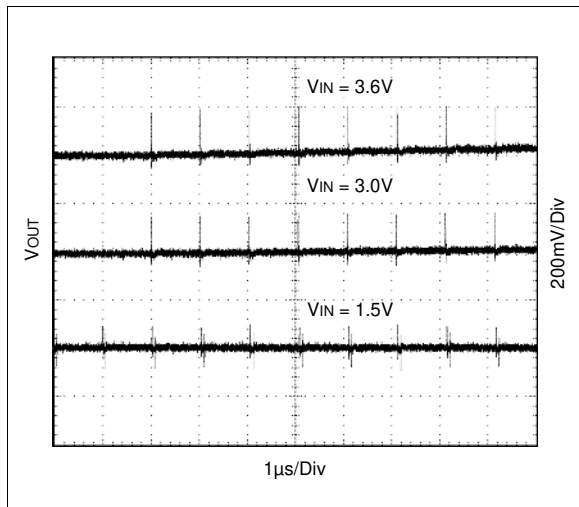

Figure 29. Output Voltage Ripple;
 $V_{OUT} = 18V$, $I_{OUT} = 20mA$

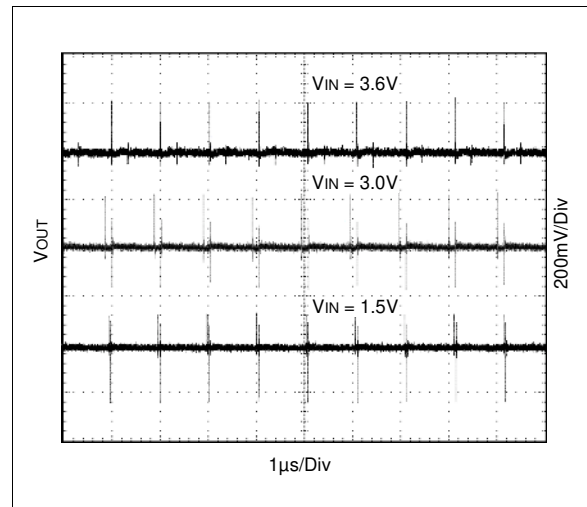

Figure 30. Load Transient Response ON;
 $V_{CC} = 3V$, $V_{OUT} = 18V$

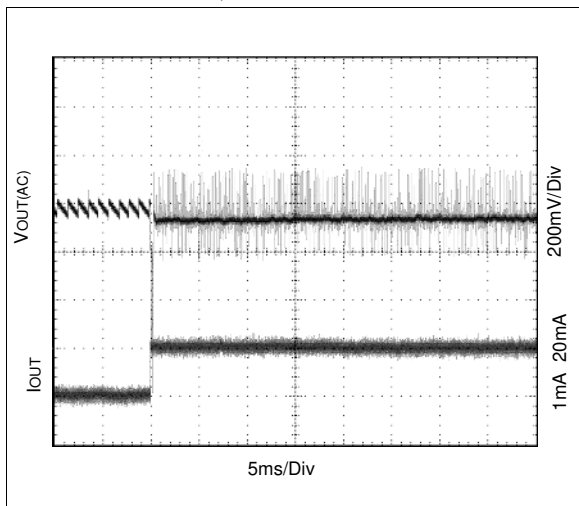
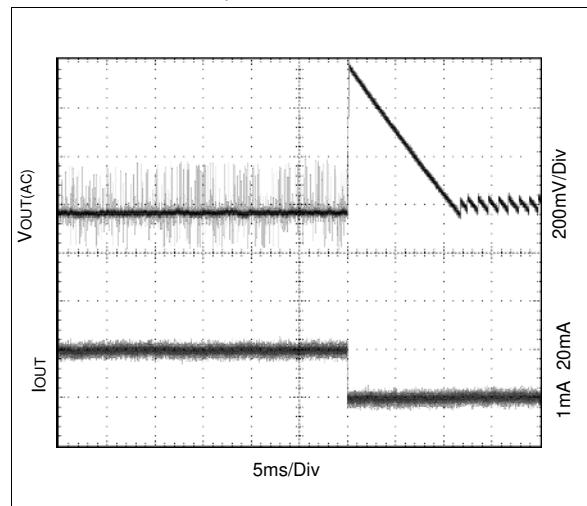

Figure 31. Load Transient Response OFF;
 $V_{CC} = 3V$, $V_{OUT} = 18V$



8 Detailed Description

The AS1344 features a current limiting circuitry, a fixed-frequency PWM architecture, power-OK circuitry, thermal protection, and an automatic powersave mode in a tiny package, and maintains high efficiency at light loads.

Figure 32. Block Diagram with Shutdown Disconnect Switch

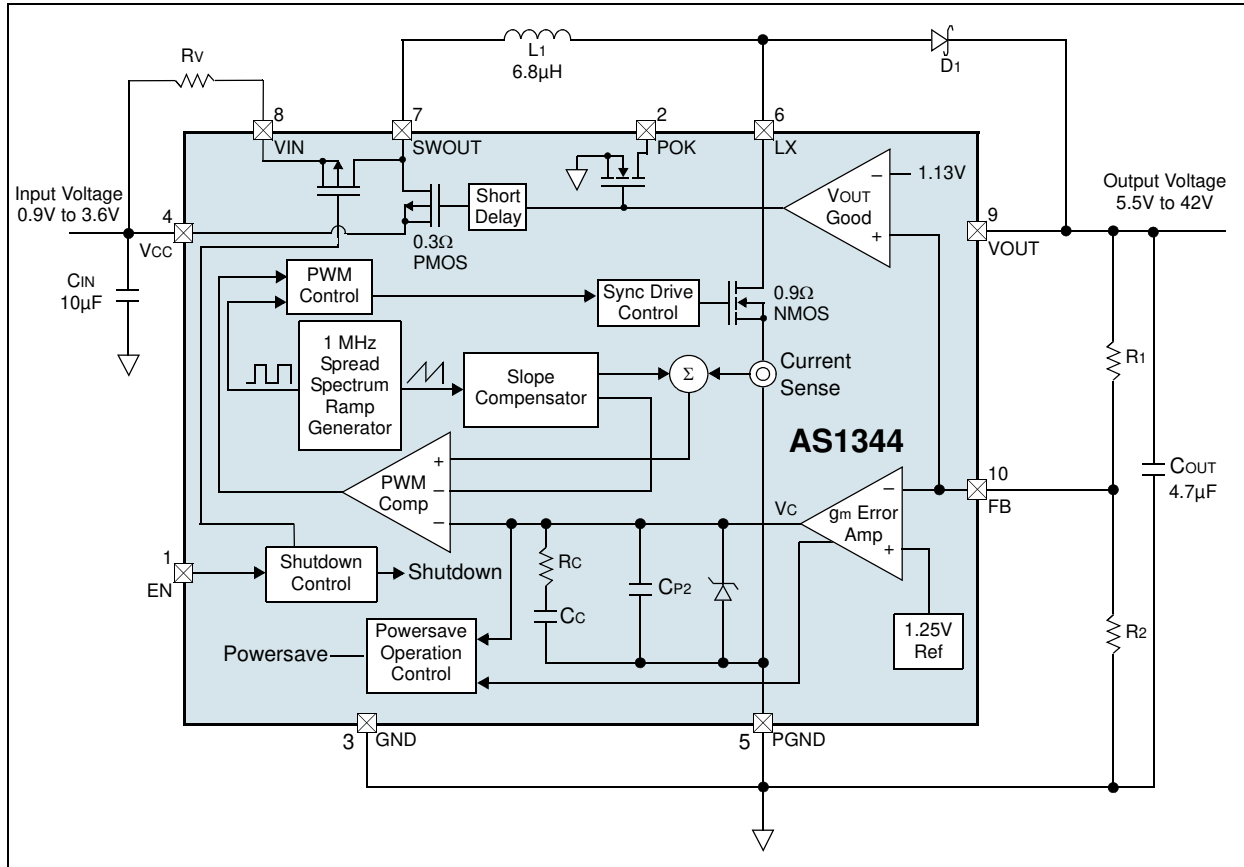

Automatic powersave mode regulates the output and also reduces average current flow into the device, resulting in high efficiency at light loads. When the output increases sufficiently, the powersave comparator output remains high, resulting in continuous operation.

For each oscillator cycle, the power switch is enabled. A voltage proportional to switch current is added to a stabilizing ramp and the resulting sum is delivered to the positive terminal of the PWM comparator.

The error amplifier compares the voltage at FB with the internal 1.25V reference and generates an error signal (V_c). When V_c is below the powersave mode threshold voltage the automatic powersave-mode is activated and the hysteretic comparator disables the power circuitry, with only the low-power circuitry still active (total current consumption is minimized).

When a load is applied, V_{FB} decreases; V_c increases and enables the power circuitry and the device starts switching. In light loads, the output voltage (and the voltage at FB) will increase until the powersave comparator disables the power circuitry, causing the output voltage to decrease again. This cycle is repeated resulting in low-frequency ripple at the output.

POK Function

The POK output indicates if the output voltage is within 90% of the nominal voltage level. As long as the output voltage is within regulation the open-drain POK output is high impedance. The POK output can be tied to any external voltage up to a maximum of 5V via a pull-up resistance R_3 (see [Typical Application on page 12](#)). If the output voltage drops below 90% of the nominal voltage the POK pin is pulled to GND.

Note: It is important to consider that in shutdown mode the POK output is pulled to V_{CC} in order to save current.

9 Application Information

Shutdown and Output Discharge

A logic low on the EN pin shuts down the AS1344 and a logic high on the EN pin powers on the device. In shutdown mode the supply current drops to below 3µA and the POK pin is set to high impedance to maximize battery life.

When the battery disconnect switch is used, the battery is disconnected from the output and the output is discharged down to 0V. The time for fully discharging the output depends on the C_{OUT} and on the load.

Note: Pin EN should not be left floating. If the shutdown feature is not used, connect EN to V_{CC}. The output will be discharged during shutdown but the output also must be fully discharged before the device is enabled again.

Battery Disconnect

The AS1344 has an integrated PMOS switch that can be used to disconnect the battery during shutdown. The operation voltage of this switch is limited to 3.6V. When EN is high, the switch is closed and supplies the inductor. Due to the R_{ON} resistance the efficiency is slightly lower if the battery disconnect switch is used.

$$P_{LOSS} = I_{IN}^2 \times R_{ON} \quad (EQ 1)$$

Softstart Function

To limit the input current during startup a resistor R_V can be connected between the pins VIN and V_{CC}. For the correlation between the resistor value, the supply voltage and the startup time see Figure 33. For the correlation between resistor value, the supply voltage and the peak current see Figure 34. Connect VIN directly to V_{CC} (no resistor) to disable the softstart Function.

As an example some peak current and time values are listed at a given R_V in Table 4.

Table 4. Timing for Softstart @ V_{CC} = 2.4V, C_{OUT} = 155µF,

R _V [Ω]	0	1.0	1.5	2.0	2.4	3.0
I _{PEAK} [A]	1.76	0.81	0.66	0.56	0.50	0.42
t [ms]	25	76	100	130	156	204

Figure 33. Startup Time; C_{IN} = 150µF, C_{OUT} = 155µF

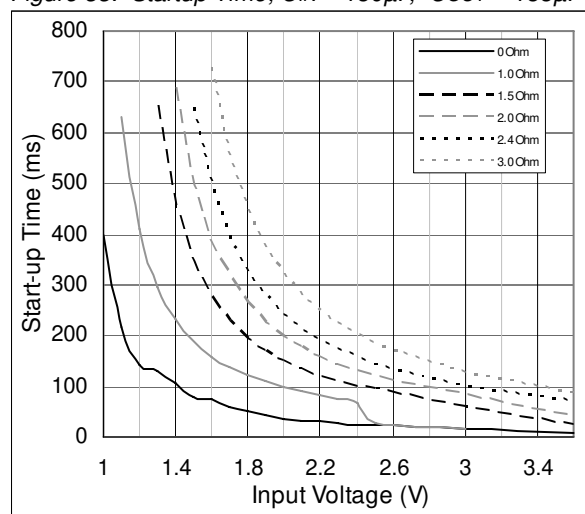
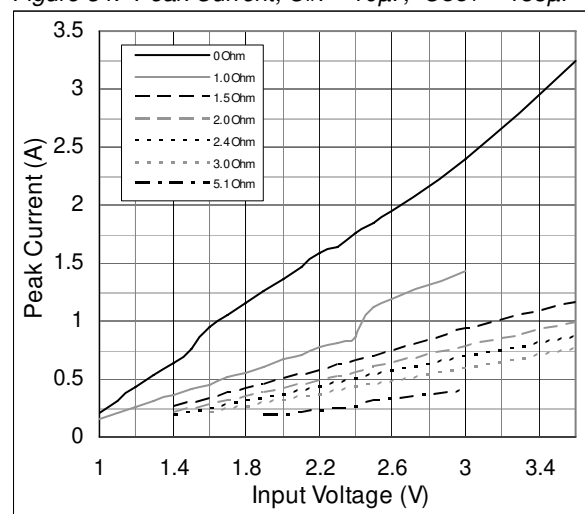

Figure 34. Peak Current; C_{IN} = 10µF, C_{OUT} = 155µF



Thermal Protection

To protect the device from short circuit or excessive power dissipation of the auxiliary NPNs, the integrated thermal protection switches off the device when the junction temperature (T_J) reaches 140°C (typ). When T_J decreases to approximately 135°C, the device will resume normal operation. If the thermal overload condition is not corrected, the device will switch on and off while maintaining T_J within the range between 135 and 140°C.

Setting Output Voltage

Output voltage can be adjusted by connecting a voltage divider between pins VOUT and FB (see Figure 35).

Figure 35. Typical Application

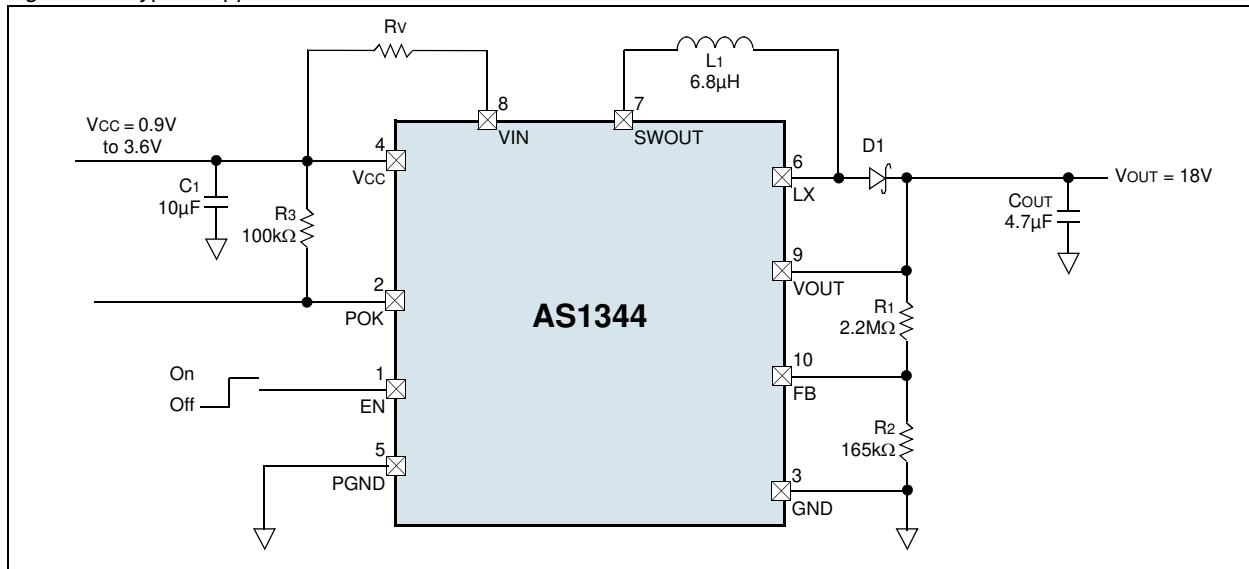

The output voltage can be adjusted by selecting different values for R_1 and R_2 . For R_2 , select a value between 10k and 200kΩ.

Calculate R_1 by:

$$R_1 = R_2 \cdot \left(\frac{V_{OUT}}{V_{FB}} - 1 \right) \quad (EQ 2)$$

Where:

$V_{OUT} = 5.5V$ to $42V$, $V_{FB} = 1.25V$; $V_{OUT} > V_{IN}$

The input bias current of FB has a maximum value of 100nA which allows for large-value resistors. For less than 1% error, the current through R_2 should be 100 times the feedback input bias current (I_{FB}). That's why the feedback current can be neglected in the calculation of V_{OUT} .

Note: For the optimal operation condition the following ratio between V_{OUT} and V_{IN} should be used:

$$V_{OUT} \div V_{IN} \leq 12 \quad (EQ 3)$$

LED Power Supply Application

The AS1344 can also be used for driving LEDs. Just simply connect the LEDs between the pins VOUT and FB. (see Figure 36).

Figure 36. LED Supply Application

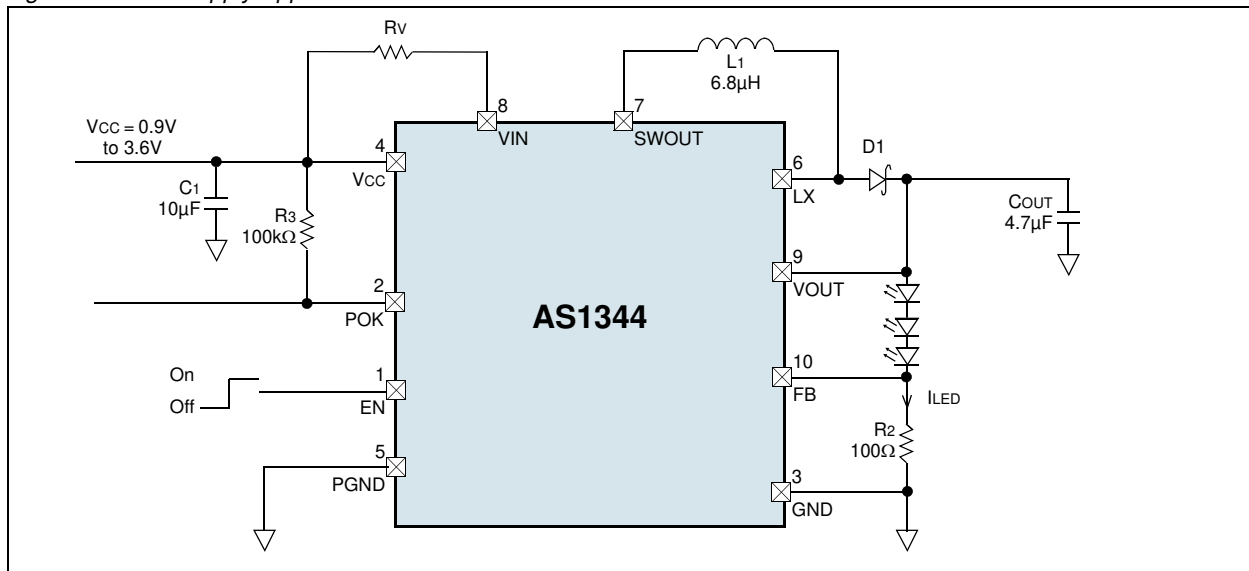

The output voltage is adjusted automatically to the required voltage of the LEDs. This voltage depends on the forward voltage (V_F) of the used LEDs and the Feedback Voltage V_{FB} .

Calculate V_{OUT} by:

$$V_{OUT} = V_F(I_{LED}) \times n + V_{FB} \quad (EQ 4)$$

Note: The brightness of the LEDs can directly be adjusted by setting the current I_{LED} via the corresponding R_2 .

Calculate R_2 by:

$$I_{LED} = \frac{V_{FB}}{R_2} \quad (EQ 5)$$

Where:

$V_{FB} = 1.25V$

n number of LEDs

Inductor Selection

For the external inductor, a 4.7 μ H or 6.8 μ H inductor will usually suffice. Minimum inductor size is dependant on the desired efficiency and output current. Inductors with low core losses and small DCR at 1MHz are recommended. It's also recommended to choose an inductor which can handle at least 1.2A without saturating. The MOS6020 is a very good choice because the DCR is quite small and the saturation current exceeds 1.2A. For space limiting applications and input currents below 650mA the EPL2014 can be selected. Efficiency losses due to higher DCR should be considered. (see [Figure 37](#) and [Figure 38](#))

Table 5. Recommended Inductors

Part Number	L	DCR	I _{SAT} @ 20% drop	Dimensions (L/W/T)	Manufacturer
EPL2014-472MLC	4.7 μ H	0.231 Ω	0.65A	2.2x2.0x1.4mm	Coilcraft www.coilcraft.com
LPS3015-472MLC	4.7 μ H	0.200 Ω	1.2A	3.1x3.1x1.5mm	
LPS4018-682MLC	6.8 μ H	0.150 Ω	1.3A	4.1x4.1x1.8mm	
LPS5030-682ML_	6.8 μ H	0.099 Ω	1.7A	4.88x4.88x3.0mm	
MOS6020-682MLC	6.8 μ H	0.078 Ω	1.56A	6.0x6.8x2.4mm	
MOS6020-472MLC	4.7 μ H	0.050 Ω	1.82A	6.0x6.8x2.4mm	

Note: For the Efficiency measurements in [Figure 37](#) and [Figure 38](#) a MBR0540 diode was used for D₁.

Figure 37. Efficiency Comparison of different Inductors; V_{IN} = 3V, V_{OUT} = 18V

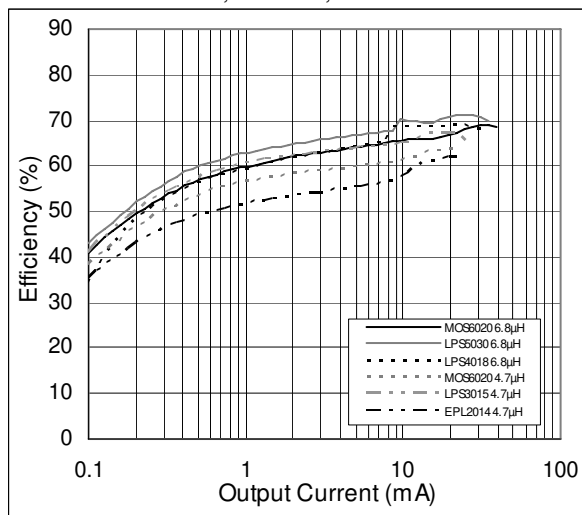
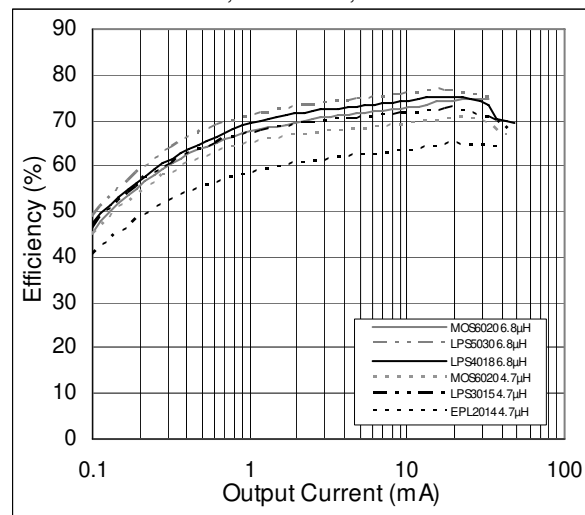

Figure 38. Efficiency Comparison of different Inductors; V_{IN} = 3.6V, V_{OUT} = 18V



Capacitor Selection

A 10 μ F capacitor is recommended for C_{IN} as well as a 4.7 μ F for C_{OUT}. Small-sized X5R or X7R ceramic capacitors should be used as they retain capacitance over wide ranges of voltages and temperatures.

Output Capacitor Selection

Low ESR capacitors should be used to minimize V_{OUT} ripple. Multi-layer ceramic capacitors are recommended since they have extremely low ESR and are available in small footprints. A 4.7 to 10 μ F output capacitor is sufficient for most applications. Larger values up to 22 μ F may be used to obtain extremely low output voltage ripple and improve transient response. The rated voltage of the capacitor should not be lower than the output voltage.

Table 6. Recommended Output Capacitors

Part Number	C	TC Code	Rated Voltage	Dimensions (L/W/T)	Manufacturer
GRM32DR71H335KA88B	3.3 μ F	X7R	50V	1210	Murata www.murata.com
GRM32ER71H475KA88	4.7 μ F	X7R	50V	1210	
GRM31CR61E106KA12	10 μ F	X5R	25V	1206	
C3225X5R1H335K	3.3 μ F	X5R	50V	1210	TDK www.tdk.com
C3216X5R1E475K	4.7 μ F	X5R	25V	1206	
C3225X5R1E106K	10 μ F	X5R	25V	1210	

Input Capacitor Selection

Low ESR input capacitors reduce input switching noise and reduce the peak current drawn from the battery. Ceramic capacitors are recommended for input decoupling and should be located as close to the device as is practical. A 10 μ F input capacitor is sufficient for most applications. Larger values may be used for a better stabilization of the supply voltage.

Table 7. Recommended Input Capacitors

Part Number	C	TC Code	Rated Voltage	Dimensions (L/W/T)	Manufacturer
GRM21BR60J106KE19	10 μ F	X5R	6.3V	0805	Murata www.murata.com
GRM188R60J106ME47	10 μ F	X5R	6.3V	0603	
GRM21BR60J226ME39	22 μ F	X5R	6.3V	0805	
C1608X5R0J106MB	10 μ F	X5R	6.3V	0603	TDK www.tdk.com
C2012X5R0J226M	22 μ F	X5R	6.3V	0805	

Diode Selection

A Schottky diode must be used to carry the output current into the Cout and load during the NMOS switch-off time.

Note: Do not use ordinary rectifier diodes, since the slow recovery times will compromise efficiency.

The MBR0520 is a good choice because of the very low forward voltage and the extremely fast switching. If the output voltage exceeds 20V the use of the PMEG4005 or the MBR0540 (40V Schottky diodes) is recommended. These diodes are designed to handle an average forward current of 500mA. In applications with higher loads, the PMEG4010 or the MBRM140 should be used, due to the rated average forward current of 1A.

Table 8. Recommended Diodes

Part Number	Reverse Voltage	Forward Current	Package	Manufacturer
MBR0540	40V	0.5A	SOD123	MCC www.mccsemi.com
MBR0520	20V	0.5A	SOD123	
PMEG4005	40V	0.5A	SOD123	Philips www.nxp.com
PMEG4010	40V	1A	SOD123	
MBRM140	40V	1A	SOD123	ON Semiconductor www.onsemi.com

Figure 39. Efficiency Comparison of different Diodes;
 $V_{IN} = 3V$, $V_{OUT} = 18V$, $L_1 = 6.8\mu H$

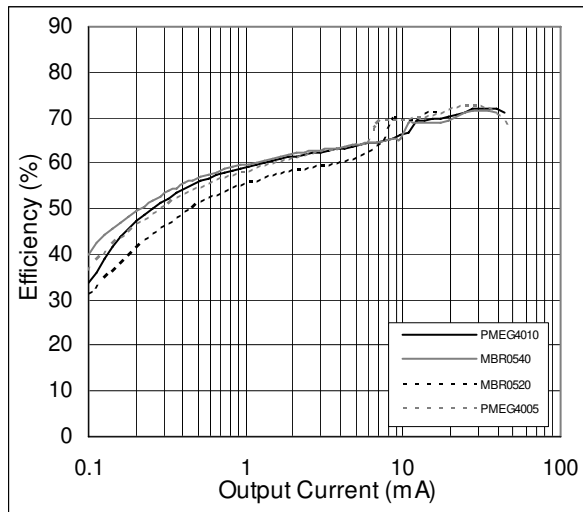
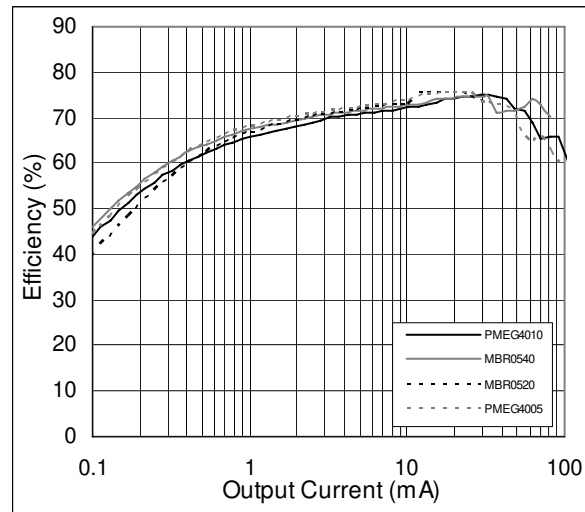

Figure 40. Efficiency Comparison of different Diodes;
 $V_{IN} = 3.6V$, $V_{OUT} = 18V$, $L_1 = 6.8\mu H$



10 Package Drawings and Markings

The devices are available in a TDFN-10 3x3mm package.

Figure 41. TDFN-10 3x3mm Package

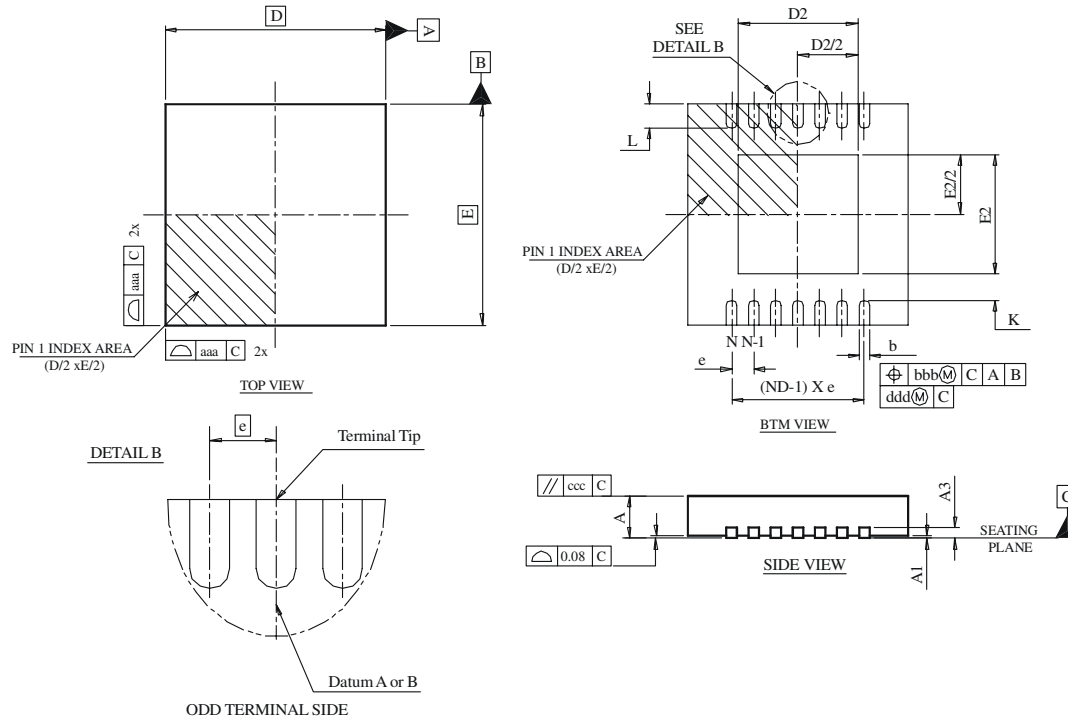

Symbol	Min	Typ	Max	Notes
A	0.70	0.75	0.80	1, 2
A1	0.00	0.02	0.05	1, 2
A3		0.20 REF		1, 2
L1	0.03		0.15	1, 2
L2			0.13	1, 2
aaa		0.15		1, 2
bbb		0.10		1, 2
ccc		0.10		1, 2
ddd		0.05		1, 2
eee		0.08		1, 2
ggg		0.10		1, 2

Symbol	Min	Typ	Max	Notes
D BSC		3.00		1, 2
E BSC		3.00		1, 2
D2	1.60		2.50	1, 2
E2	1.35		1.75	1, 2
L	0.30	0.40	0.50	1, 2
θ	0°		14°	1, 2
K	0.20			1, 2
b	0.18	0.25	0.30	1, 2, 5
e		0.50		
N		10		1, 2
ND		5		1, 2, 5

Notes:

- Figure 41 is shown for illustration only.
- All dimensions are in millimeters; angles in degrees.
- Dimensioning and tolerancing conform to ASME Y14.5 M-1994.
- N is the total number of terminals.
- The terminal #1 identifier and terminal numbering convention shall conform to JEDEC 95-1, SPP-012. Details of terminal #1 identifier are optional, but must be located within the zone indicated. The terminal #1 identifier may be either a mold or marked feature.
- Dimension b applies to metallized terminal and is measured between 0.15mm and 0.30mm from the terminal tip.
- ND refers to the maximum number of terminals on side D.
- Unilateral coplanarity zone applies to the exposed heat sink slug as well as the terminals

11 Ordering Information

The device is available as the standard products shown in [Table 9](#).

Table 9. Ordering Information

Ordering Code	Marking	Description	Delivery Form	Package
AS1344-BTDT	ASR7	42V, DC-DC Boost Converter with adjustable Softstart	Tape and Reel	TDFN-10 3x3mm

Note: All products are RoHS compliant and Pb-free.

Buy our products or get free samples online at ICdirect: <http://www.austriamicrosystems.com/ICdirect>

For further information and requests, please contact us <mailto:sales@austriamicrosystems.com>
or find your local distributor at <http://www.austriamicrosystems.com/distributor>

Copyrights

Copyright © 1997-2009, austriamicrosystems AG, Tobelbaderstrasse 30, 8141 Unterpremstaetten, Austria-Europe. Trademarks Registered ®. All rights reserved. The material herein may not be reproduced, adapted, merged, translated, stored, or used without the prior written consent of the copyright owner.

All products and companies mentioned are trademarks or registered trademarks of their respective companies.

Disclaimer

Devices sold by austriamicrosystems AG are covered by the warranty and patent indemnification provisions appearing in its Term of Sale. austriamicrosystems AG makes no warranty, express, statutory, implied, or by description regarding the information set forth herein or regarding the freedom of the described devices from patent infringement. austriamicrosystems AG reserves the right to change specifications and prices at any time and without notice. Therefore, prior to designing this product into a system, it is necessary to check with austriamicrosystems AG for current information. This product is intended for use in normal commercial applications. Applications requiring extended temperature range, unusual environmental requirements, or high reliability applications, such as military, medical life-support or life-sustaining equipment are specifically not recommended without additional processing by austriamicrosystems AG for each application. For shipments of less than 100 parts the manufacturing flow might show deviations from the standard production flow, such as test flow or test location.

The information furnished here by austriamicrosystems AG is believed to be correct and accurate. However, austriamicrosystems AG shall not be liable to recipient or any third party for any damages, including but not limited to personal injury, property damage, loss of profits, loss of use, interruption of business or indirect, special, incidental or consequential damages, of any kind, in connection with or arising out of the furnishing, performance or use of the technical data herein. No obligation or liability to recipient or any third party shall arise or flow out of austriamicrosystems AG rendering of technical or other services.



Contact Information

Headquarters

austriamicrosystems AG
Tobelbaderstrasse 30
A-8141 Unterpremstaetten, Austria

Tel: +43 (0) 3136 500 0
Fax: +43 (0) 3136 525 01

For Sales Offices, Distributors and Representatives, please visit:

<http://www.austriamicrosystems.com/contact>