



FEATURES

- Converter and Evaluation Development (EVAL-CED1Z) and Control Board (EVAL-CONTRL BRDxZ) compatibility
- Versatile analog signal conditioning circuitry
- On-board reference, clock oscillator and buffers
- Buffered 14, 16 (or 18) bit parallel outputs
- Buffered serial port interface
- Ideal for DSP and data acquisition card interfaces
- Analog and digital prototyping area
- PC software for control and data analysis

GENERAL DESCRIPTION

The EVAL-AD76XXCBZ is an evaluation board for the 48 lead AD761X, AD762X, AD763X, AD764X, AD765X, AD766X, AD767X and AD795X 14-bit, 16-bit and 18-bit PulSAR[®] analog to digital converter (ADC) family. These low power, successive approximation register (SAR) architecture ADCs (see ordering guide for product list) offer very high performance with 100kSPS to 3MSPS throughput rate range with a flexible parallel or serial interface. The evaluation board is designed to demonstrate the ADC's performance and to provide an easy to understand interface for a variety of system applications. A full description of the AD761X, AD762X, AD763X, AD764X, AD765X, AD766X, AD767X and AD795X is available in the

Analog Devices data sheets and should be consulted when utilizing this evaluation board.

The evaluation board is ideal for use with either Analog Devices Converter and Evaluation Development EVAL-CED1Z, (CED) or Evaluation Control Board EVAL-CONTRL BRDxZ (ECB) capture boards, or as a stand-alone system. The design offers the flexibility of applying external control signals and is capable of generating conversion results on parallel 14-bit, 16-bit or 18-bit wide buffered outputs.

On-board components include a high precision band gap reference, (AD780, ADR431, or ADR435), reference buffers, a signal conditioning circuit with two op-amps and digital logic.

The EVAL-AD76xxCBZ interfaces to the capture board with a 96-pin DIN connector. A 40-pin IDC connector is used for parallel output, and test points are provided for the serial port. SMB connectors are provided for the low noise analog signal source, and for an externally generated CNVST (convert start input).

The term AD76XX-48 is used in this document to represent all the 48 lead PulSAR ADCs listed in the ordering guide. CED is used for the EVAL-CED1Z and ECB is used for the EVAL-CONTROL BRDxZ capture boards.

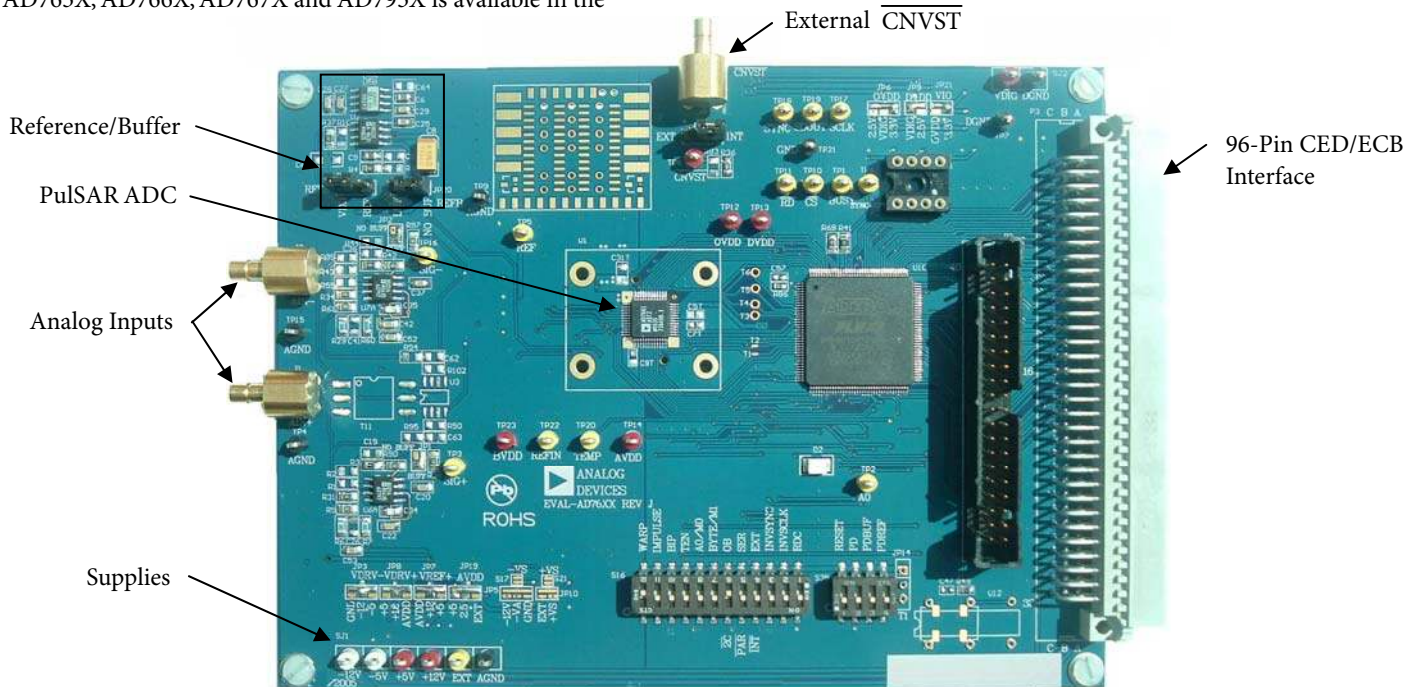

Figure 1. Evaluation Board

Rev. PrA

Information furnished by Analog Devices is believed to be accurate and reliable. However, no responsibility is assumed by Analog Devices for its use, nor for any infringements of patents or other rights of third parties that may result from its use. Specifications subject to change without notice. No license is granted by implication or otherwise under any patent or patent rights of Analog Devices. Trademarks and registered trademarks are the property of their respective owners.

TABLE OF CONTENTS

FEATURES 1

GENERAL DESCRIPTION 1

 Overview..... 3

 Conversion Control/Master Clock..... 3

 Analog Input 3

 Power Supplies and Grounding..... 3

 Using the Eval-AD762X/AD765X/AD766X/ AD767XCBZ as Stand-Alone..... 3

 Schematics/PCB Layout..... 4

 Supplying Power for Stand-Alone use 4

 Evaluation Board Setting for Bipolar ADC Input Configurations 4

 Hardware Setup4

 Software Installation5

 Running the Software5

 DC Testing - Histogram6

 AC Testing.....6

 Decimated AC Testing.....6

 Serial Programmable Port (AD7610, AD7612, AD7631, AD7634, AD7951, AD7952).....6

 Table 5. Test Points9

 Ordering gUIDE..... 29

LIST OF FIGURES

Figure 1. Evaluation Board 1

Figure 2. Schematic, Analog 10

Figure 3. Schematic, Digital 11

Figure 4. Schematic, Power 12

Figure 5. Top Side Silk-Screen..... 13

Figure 6. Top Layer 13

Figure 7. Ground Layer 14

Figure 8. Shield Layer 14

Figure 9. Bottom Side Layer 15

Figure 10. Bottom Side Silk-Screen 15

Figure 11. Setup Screen 16

Figure 12. Context Help 17

Figure 13. Histogram Screen 18

Figure 14. Summary 19

Figure 15. FFT Spectrum 20

Figure 16 .Oscilloscope..... 21

Figure 17 .Decimated FFT..... 22

Figure 18. Setup Screen 23

Figure 19. Histogram Screen 24

Figure 20. FFT Screen 25

Figure 21. Time-Domain Screen 26

Figure 22. Decimated (Averaging) Screen..... 27

Figure 23. Serial Programmable Port (SPP) Screen (AD7610/7612/7631/7634/7951/7952 only)..... 28

LIST OF TABLES

Table 1. CNVST Generation, Analog Input Range 7

Table 2. Jumper Description..... 8

Table 3. S16 - Configuration Select Switch Description 8

Table 4. S35 - Configuration Select Switch Description 9

Table 5. Test Points9

Table 6. Bill of Materials for the Connectors9

OVERVIEW

Figure 1 shows the EVAL-AD76XXCBZ evaluation board. When used in stand-alone mode or in conjunction with the CED/ECB, the gate array, U10, provides the necessary control signals for conversion and buffers the ADC data. The evaluation board is a flexible design that enables the user to choose among many different board configurations, analog signal conditioning, reference, and different modes of conversion data.

CONVERSION CONTROL/MASTER CLOCK

Conversion start ($\overline{\text{CNVST}}$) controls the sample rate of the ADC and is the only input needed for conversion; all SAR timing is generated internally. $\overline{\text{CNVST}}$ is generated either by the gate array or externally via J3 (SMB) and setting JP22 in the external (EXT) position. The evaluation board is factory configured for the $\overline{\text{CNVST}}$ range shown in Table 1. Externally generated $\overline{\text{CNVST}}$ should have very low jitter and sharp edges for the maximum dynamic performance of the part. Since $\overline{\text{CNVST}}$ jitter usually results in poor SNR performance, it is recommended to use the on-board $\overline{\text{CNVST}}$ generation whenever possible.

The master clock (MCLK) source for the gate array is generated from the CED/ECB capture board or from U12, the 40MHz local oscillator selectable when using the accompanying software. The range for $\overline{\text{CNVST}}$ in Table 1 is a ratio generated from this master clock. In stand-alone mode, other clock frequencies can be used to change the gate array generated $\overline{\text{CNVST}}$ by this ratio. However, other timings will be affected – namely the slave serial clock (SCLK) interface. In serial slave mode, $\text{SCLK} = \text{MCLK}$.

While the ADC is converting, activity on the BUSY pin turns on the LED, D2. Additionally, the BUSY signal can be monitored test point TP1. Buffered conversion data (BD) is available at U10 on the output bus BD[0:15] on the 40-pin IDC connector P2, and on the 96-pin connector P3. When operating with the ECB/CED, data is transferred using a 16 bit bus and corresponding word and byte modes selectable with the software. For the 18 bit converters two consecutive 16 bit words are read, however, the ADC data is still read into the gate array as 18 bits. Additionally, BD is updated on the falling edge of BBUSY on P3-C17, and on the rising edge of DBUSY on P2-33. When either parallel or serial reading mode of the ADC is used, data is available on this parallel bus.

When using Serial Mode, serial data is available at T3, T4, T5, and T6 (SDOUT, SCLK, SYNC and RDERROR) and buffered serial data is output on TP17, TP18, and TP19 (SCLK, SYNC, and SDOUT). When using Slave Serial Mode, the external serial clock SCLK applied to the ADC is the MCLK, U12, frequency (40MHz). Refer to the device specific datasheet for full details of the interface modes.

ANALOG INPUT

The analog input amplifier circuitry (U6, U7 and discretes) allows configuration changes such as positive or negative gain, input range scaling, filtering, addition of a DC component, use of different op-amp and supplies depending on the ADC. The analog input amplifiers are set as unity gain buffers at the factory. The supplies are selectable with solder pads and are set for the $\pm 12\text{V}$ range. Table 1 shows the analog input range for the available evaluation boards.

The default configuration for the single ended (SE) unipolar ADCs sets U6 at mid-scale from the voltage divider ($V_{\text{CM}} * R6/(R6+R7)$) and U7 at mid-scale from the voltage divider ($V_{\text{CM}} * R29/(R29+R60)$) for the differential unipolar ADCs.

For the bipolar devices, the input is at 0V (mid-scale). This allows a transition noise test (histogram) without any other equipment. In some applications, it is desired to use a bipolar or wider analog input range, for instance, $\pm 10\text{V}$, $\pm 5\text{V}$, $\pm 2.5\text{V}$, or 0 to -5V . For the AD76XX-48 parts which do not use these input ranges directly, simple modifications of the input driver circuitry can be made without any performance degradation. Refer to the datasheet under the *Application Hints* section for component values or to application note AN594 on the product web page for other input ranges.

For dynamic performance, an FFT test can be done by applying a very low distortion AC source.

POWER SUPPLIES AND GROUNDING

The evaluation board ground plane is separated into two sections: a plane for the digital interface circuitry and an analog plane for the analog input and external reference circuitry. To attain high resolution performance, the board was designed to ensure that all digital ground return paths do not cross the analog ground return paths by connecting the planes together directly under the converter. Power is supplied to the board through P3 when using with the EVAL-CONTROL-BRDX

USING THE EVAL-AD762X/AD765X/AD766X/AD767XCBZ AS STAND-ALONE

Using the evaluation board as stand-alone does not require the CED/ECB nor does it require use of the accompanied software. When the CONTROL input to the gate array is LOW, which is pulled down by default, the gate array provides the necessary signals for conversion and buffers the conversion data.

In stand-alone mode, the gate arrays flexible logic buffers the ADC data according to the read data mode configuration (word or byte). In parallel reading mode the board is configured for continuous reading since CS and RD are always driven LOW by the gate array. Thus, the digital bus is not tri-stated in this mode of operation and BD[0:15] will continuously be updated after a new conversion. BD[0:15] is available on P2 after BUSY goes HIGH. Note that with the 18 bit devices the full 18 bits of data BD[-2:15] are output directly on P2 since the evaluation board

is not limited to 16 bit wide transfers in stand-alone operation. When either parallel or serial reading mode, the data is available on this parallel bus. Refer to Figure 3 to obtain the data output pins on P2.

Configuration Switches

The evaluation board is configurable for the different operating modes with 16 positions on the configuration select switches, S16 and S35. A description of each switch setting and jumper position is listed in Figure 3 and the available test points are listed in Table 5. Note that the switches in the ON position define a logic HIGH level (pulled up with 10k Ω .) and that the switches are active only in stand-alone mode.

For all interface modes, S16 and S35 allows the selection of:
Warp, Normal or Impulse mode conversions (where applicable)
Binary or 2s complement data output
Reading during or after conversion
Resetting the ADC
ADC power-down
Internal Reference and Buffer power-down (where applicable)

In parallel reading mode, s16 allows the selection of:
Byte swapping for 8 bit interfacing (LSByte with MSByte)
18-bit, 16-bit and 8-bit interfacing (for 18-bit converters)

In serial reading mode, the default settings are Master Read during Conversion Mode using the internal ADC serial clock. Serial data is available at T3, T4, T5 and T6 for SDOOUT, SCLK, SYNC and RDERROR respectively. Buffered serial data is output on the three test points TP17, TP18 and TP19 for SCLK, SYNC, and SDOOUT respectively.

For serial reading mode, S16 allows the selection of:
Choice of inverting SCLK and SYNC
Choice of using internal or external (slave mode) SCLK

SCHEMATICS/PCB LAYOUT

The EVAL-AD76XXCBZ is a 4-layer board carefully laid out and tested to demonstrate the specific high accuracy performance of the AD76XX-48 device. Figure 2 to Figure 4 show the schematics of the evaluation board. The printed circuit layouts of the board are given in Figure 5 - Figure 10. Note these layouts are not to scale.

Top side silk-screen - Figure 5
Top side layer - Figure 6
Ground layer - Figure 7
Shield layer - Figure 8
Bottom side layer - Figure 9
Bottom side silk-screen - Figure 10

SUPPLYING POWER FOR STAND-ALONE USE

Power needs to be supplied through the two power supply blocks SJ1 and SJ2. Linear supplies are recommended. SJ1 is the analog supply for the ADC (AVDD), front end op amps and reference circuitry. SJ2 is the digital supply for the ADC (DVDD, OVDD) and gate array. The supplies to the device are

configurable through the power supply jumpers shown in Table 2. In most applications four supplies are required; $\pm 12V$ and $+5V$ for analog, and $+5V$ for digital. On board regulators, where applicable, are used to reduce the operating voltages to the correct levels. The analog and digital supplies can be from the same source however, R27 (typically 20 Ω) is required from AVDD to DVDD. In this configuration, JP9, DVDD selection, should be left open. Furthermore, the OVDD (ADC digital output supply) may need to be brought up after the analog $+5V$ supply. See datasheet for details.

EVALUATION BOARD SETTING FOR BIPOLAR ADC INPUT CONFIGURATIONS

The AD7610, AD7612, AD7631, AD7634, AD7663, AD7665, AD7671, AD7951 and AD7952 can use both unipolar and bipolar ranges. The available options are $\pm 10V$, $\pm 5V$, $\pm 2.5V$, 0 to 10V, 0 to 5V and 0 to 2.5V (depending on the ADC).

For the AD7663, AD7665 and AD7671 the evaluation board is set for the $\pm 5V$ bipolar input range since these ADCs input ranges are hardware pin strapped. Simple modifications to these evaluation boards can be made to accommodate the different input ranges by changing the INA-IND inputs with the available solder pads.

iCMOS ADCs

For the AD7610, AD7612, AD7631 AD7634 and AD7951, the evaluation board can use all input ranges since the input range is controlled by software (or S16 DIP switches in stand-alone mode).

For operating in unipolar mode for any of the bipolar evaluation boards it is recommended to use the voltage divider consisting of $(V_{CM} * R6 / (R6 + R7))$ and $(V_{CM} * R29 / (R29 + R60))$. This allows a transition noise test without any additional equipment.

HARDWARE SETUP

Using EVAL-CED1Z Capture Board

- EVAL-AD762xCBZ or EVAL-AD764xCBZ PulsAR ADC evaluation board
- EVAL-CED1Z
- Enclosed World compatible 7V DC supply
- Enclosed USB to mini USB cable

Proceed to the Software Installation section to install the software. **Note: The EVAL-CED1Z board must not be connected to the PC's USB port until the Software is installed.** The 7V DC supply can be connected however to check the board has power (green LED lit).

Using EVAL-CONTROL BRDxZ Capture Board

- PulSAR ADC evaluation board
- Evaluation Control Board 3 (or Board 2, not in production any longer)
- AC Power Supply (AC 14V/1A source - can be purchased from ADI)

- IEEE 1284 Compliant Parallel Port Cable (if not supplied)

Connect the control board supplied mini plug to the 14V AC source. Connect the evaluation board to the controller board and connect the parallel port cable to the evaluation board and to the PC. Proceed to the Software Installation section to install the software.

SOFTWARE INSTALLATION

This section covers software installation for both versions of capture boards; ECB only and CED. It is recommended to close all Windows’ applications prior to installing the software.

System Requirements

- PC operating Windows 2000 or XP.
- USB 2.0 (for CED board)
- Bidirectional enhanced parallel port (for ECB board)
- Administrator privileges

CD-ROM –Double click on *setup.exe* and follow the instructions on the screen.

Website Download

After downloading the software, it is recommended to use the WinZip “Extract” function to extract all of the necessary components as opposed to just clicking on *setup.exe* in the zipped file. After extracting, click on *setup.exe* in the folder created during the extraction and follow the instructions on the screen.

CED Version – (AD76xx Evaluation Software CED, Rev x.x)

The software will also install the necessary USB drivers. Note that this version of software can be used for both CED and ECB capture boards. When using the ECB capture board, the PC must be rebooted. After installing the software, power up the CED board and connect to the PC USB 2.0 port. The Windows “Found New Hardware” Wizard will display. Click on Next to install the drivers automatically.



When installed properly, Windows displays the following.

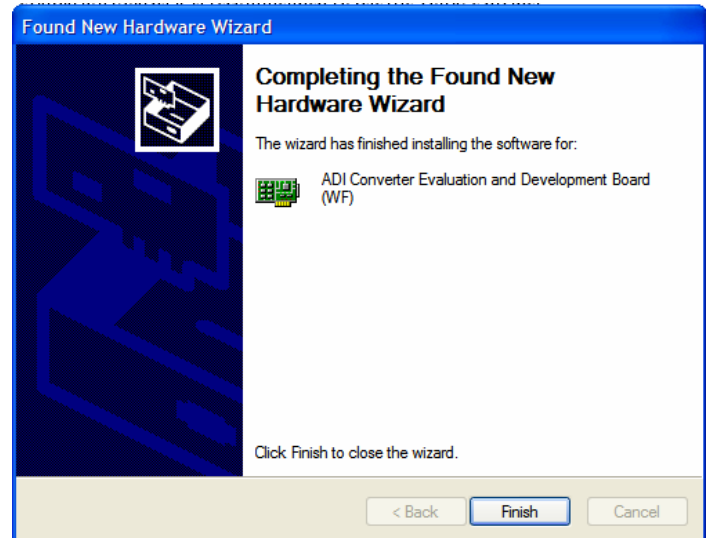

The “Device Manager” can be used to verify that the driver was installed successfully.

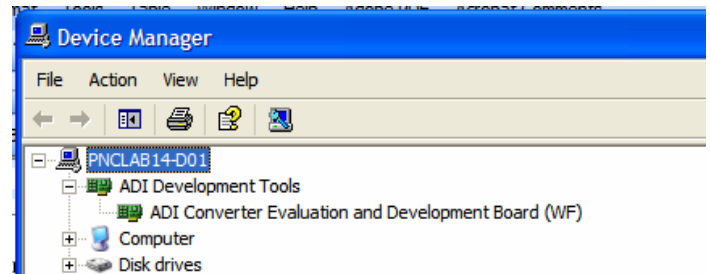

ECB only Version (AD76xx Evaluation Software ECB, Rev x.x)

After the software is finished installing, reboot the computer. This driver will not take effect unless the computer is rebooted.

RUNNING THE SOFTWARE

This document covers both versions of software: CED and ECB only. The evaluation board includes software for analyzing the AD761X, AD762X, AD763X, AD764X, AD765X, AD766X, AD767X, AD795X, AD67X and AD97x family. The EVAL-CED1Z or EVAL-CONTROL-BRDZX is required when using the software. The software is used to perform the following tests:

- Histogram for determining code transition noise (DC)
- Fast Fourier transforms (FFT) for signal to noise ratio (SNR), SNR and distortion (SINAD), total harmonic distortion (THD) and spurious free dynamic range (SFDR)
- Decimation (digital filtering)

CED Version

Refer to Figure 11 to Figure 17 for further details and features of the software. Currently the evaluation boards supported in this version are limited to EVAL-AD76yyECBZ where yy = 21, 22, 23, 41, or 43.

The software is located at C:\Program Files\Analog Devices\Hi-res ADC's CED x.x.

A shortcut is also added to the Windows "Start" menu under "Analog Devices", "Hi-Res ADC's Evaluation Software CED Rev x.x". To run the software, select the program "ADC Eval SW CED.exe" from either location. Note that the ECB can be used with this version of software as well.

ECB Version

All of the evaluation boards are supported in this version. Refer to Figure 18 to Figure 22 for further details and features of this software. The software is located at C:\Program Files\Analog Devices\Hi-res ADC's.

A shortcut is also added to the Windows "Start" menu under "Analog Devices", "Hi-Res ADC's Evaluation Software Rev x.x". To run the software, select the program "ADC.exe" from either location.

DC TESTING - HISTOGRAM

This tests the ADC for the code distribution for DC input and computes the mean and standard deviation, or transition noise of the converter and displays the results. Raw data is captured and passed to the PC for statistical computations. To perform a histogram test, select "Histogram" from the test selection window and click on the "Start" radio button. Note: a histogram test can be performed without an external source since the evaluation board has a buffered $V_{REF}/2$ source at the ADC input for unipolar parts and at 0V for bipolar devices. To test other DC values, apply a source to the J1/J2 inputs. It is advised to filter the signal to make the DC source noise compatible with that of the ADC. C26/C41 provide this filtering.

AC TESTING

This tests the traditional AC characteristics of the converter and displays a Fast Fourier Transform (FFT) of the result. As in the histogram test, raw data is captured and passed to the PC where the FFT is performed thus displaying SNR, SINAD, THD and SFDR. The data can also be displayed in the time domain. To

perform an AC test, apply a sinusoidal signal to the evaluation board at the SMB inputs J1 for IN+ and J2 for IN-. Low distortion, better than 100dB, is required to allow true evaluation of the part. One possibility is to filter the input signal from the AC source. There is no suggested bandpass filter but consideration should be taken in the choice. Furthermore, if using a low frequency bandpass filter when the full-scale input range is more than a few V_{pp} , it is recommended to use the on board amplifiers to amplify the signal, thus preventing the filter from distorting the input signal.

DECIMATED AC TESTING

The AC performances can be evaluated after digital filtering with enhanced resolution of up to 32 bits. Additional bits of resolution are attained when over sampling by:

$$f_{\text{OVERSAMPLE}} = 4^N * f_{\text{SAMPLE}}$$

where, N = number of bits and 4^N = the DRATIO. Set the DRATIO to the amount of over sampling desired. When using decimation, the test duration increases with the larger number of samples taken. The decimated test requires the EVAL-CONTROL-BRD3.

SERIAL PROGRAMMABLE PORT (AD7610, AD7612, AD7631, AD7634, AD7951, AD7952)

Figure 23 is a screen showing the flexible serial programmable port (SPP) used on the AD7610, AD7612, AD7631, AD7634 and AD7951 iCMOS ADCs. The SPP can be used in any serial mode and allows the configuration of: unipolar and bipolar input ranges, mode selection, straight binary or 2's complement output coding, and power down. The software demo allows two different configurations and alternates between these two every ten samples. To use just one range or mode, simply enter the same values into both "A" and "B" configuration windows. Note that when using the unipolar input ranges, a common mode voltage must be provided externally (DC coupled) as the board is configured with the common mode = 0V.

Table 1. $\overline{\text{CNVST}}$ Generation, Analog Input Range

Part	Res (bits)	Sample Rate	Analog Input Range	Analog Input Type
AD7610	16	250kSPS	0-5V, 0-10V, +/-5V, +/-10V	SE
AD7612	16	750kSPS	0-5V, 0-10V, +/-5V, +/-10V	SE
AD7621	16	3MSPS	0 to 2.5V	Diff, Unipolar
AD7622	16	2MSPS	0 to 2.5V	Diff, Unipolar
AD7623	16	1.33MSPS	0 to 2.5V	Diff, Unipolar
AD7625	16	4.5MSPS	0 to 2.5V	Diff, Unipolar
AD7631	16	250kSPS	0-5V, 0-10V, +/-5V, +/-10V	Diff
AD7634	16	670kSPS	0-5V, 0-10V, +/-5V, +/-10V	Diff
AD7641	18	2MSPS	0 to 2.5V	Diff, Unipolar
AD7643	18	1.25MSPS	0 to 2.5V	Diff, Unipolar
AD7650	16	571KSPS	0 to 2.5V	SE, Unipolar
AD7651	16	100KSPS	0 to 2.5V	SE, Unipolar
AD7652	16	500KSPS	0 to 2.5V	SE, Unipolar
AD7653	16	1MSPS	0 to 2.5V	SE, Unipolar
AD7654	16	500KSPS	0 to 5V	2-CH, SE Unipolar
AD7655	16	500KSPS	0 to 5V	4-CH, SE Unipolar
AD7660	16	100KSPS	0 to 2.5V	SE, Unipolar
AD7661	16	100KSPS	0 to 2.5V	SE, Unipolar
AD7663	16	250KSPS	+/-5V	SE, Bipolar
AD7664	16	571KSPS	0 to 2.5V	SE, Unipolar
AD7665	16	571KSPS	+/-5V	SE, Bipolar
AD7666	16	500KSPS	0 to 2.5V	SE, Unipolar
AD7667	16	1MSPS	0 to 2.5V	SE, Unipolar
AD7671	16	1MSPS	+/-5V	SE, Bipolar
AD7674	18	800KSPS	0 to 5V	Diff, Unipolar
AD7675	16	100KSPS	+/-2.5V	Diff, Unipolar
AD7676	16	500KSPS	+/-2.5V	Diff, Unipolar
AD7677	16	1MSPS	+/-2.5V	Diff, Unipolar
AD7678	18	100KSPS	0 to 5V	Diff, Unipolar
AD7679	18	571KSPS	0 to 5V	Diff, Unipolar
AD7951	14	1MSPS	0-5V, 0-10V, +/-5V, +/-10V	SE
AD7952	14	1MSPS	0-5V, 0-10V, +/-5V, +/-10V	Diff

Table 2. Jumper Description

Jumper	Name	Default Position	Function
JP1, JP2	BUFF	BUFF	Buffer amplifier: BUFF = use op amps to buffer analog input. NO BUFF = direct input from J1, J2 (SMB).
JP3	VDRV-	-12V	Buffer amplifier negative supply: Selection of -12V, -5V or GND when using EVAL-CONTROL-BRDX or voltages on SJ1 in stand alone mode.
JP4	REFS	REF	Reference selection: REF = use on board reference output for ADC reference. VDD = use analog supply (AVDD) for ADC reference.
JP6	OVDD	3.3V	ADC digital output supply voltage: Selection of 2.5V, 3.3V and VDIG. VDIG = +5V when using EVAL-CONTROL-BRDX or voltage on SJ2 in stand-alone mode.
JP7	VREF+	+12V	Reference circuit positive supply: Selection of +12V, +5V or AVDD when using EVAL-CONTROL-BRDX or voltages on SJ1 in stand alone mode.
JP8	VDRV+	+12V	Buffer amplifier positive supply: Selection of +12V, +5V or AVDD when using EVAL-CONTROL-BRDX or voltages on SJ1 in stand alone mode.
JP9	DVDD	VDIG/2.5 ¹	ADC digital supply voltage: Selection of +2.5V or VDIG (+5V) when using EVAL-CONTROL-BRDX or voltage on SJ2 in stand-alone mode.
JP19	AVDD	+5V/2.5 ¹	ADC analog supply voltage: Selection of +2.5V, +5V or EXT when using EVAL-CONTROL-BRDX
JP20	REFB	BUF	Reference buffer: BUFF = use U2 to buffer or amplify reference source. NO BUFF = use reference directly into ADC.
JP21	VIO	3.3V	Gate array I/O voltage: Selection of 3.3V or OVDD. Note: gate array will be damaged if >3.3V (ie. when using OVDD = VDIG).
JP22	CNVST	INT	CNVST source: INT = use gate array to generate CNVST. EXT = use external source into J3, SMB for CNVST.

¹ For AD7621/22/23//25/41/43 these are set to +2.5V. Note that setting these to +5V will permanently destruct the ADC.

Table 3. S16 - Configuration Select Switch Description

Note: (OFF = LOW, ON = HIGH)

Position	Name	Default Position	Function
1	WARP	LOW	Conversion mode selection: Used in conjunction with IMPULSE. When HIGH with IMPULSE = LOW, the fastest (Warp) mode is used for maximum throughput. When LOW and IMPULSE = LOW, Normal mode is used.
2	IMPULSE	LOW	Conversion mode selection: Used in conjunction with WARP. When HIGH with WARP = LOW, a reduced power mode is used in which the power consumption is proportional to the throughput rate.
3	BIP	LOW	For future use.
4	TEN	LOW	For future use.
5	A0/M0	LOW	A0, input Mux selection: Used for AD7654/AD7655 (refer to datasheet). M0, data output interface selection: Used along with M1 for 18-bit ADCs.
6	BYTE/M1	LOW	BYTESWAP, used for 8-bit interface mode on 16-bit ADCs: MSByte is swapped with LSByte on 8 data lines. M1, data output interface selection: Used along with M0 for 18-bit ADCs.
7	OB/ $\overline{2C}$	HIGH	Data output select: LOW = Use 2's complement output. HIGH = Straight binary output.
8	SER/ \overline{PAR}	LOW	Data output interface select: LOW = Parallel interface. HIGH = Serial interface.
9	EXT/ \overline{INT}	LOW	Serial clock source select: LOW = Use ADC internal serial clock, SCLK is an output. HIGH = Use external clock, which is MCLK (40 MHz) and SCLK is an input. Not used in parallel reading mode.
10	INVSYNC	LOW	Serial sync (SYNC) active state: LOW = SYNC is active HIGH. HIGH = SYNC is active LOW. Used only for Master mode (internal SCLK). Not used in parallel reading mode.
11	INVSCLK	LOW	Serial clock (SCLK) active edge: LOW = Use SCLK falling edge. HIGH = Use SCLK rising edge. Active in all serial modes. Not used in parallel reading mode.
12	RDC	LOW	Read during convert: LOW = Read data after conversion (BUSY = LOW). HIGH = Read data during conversions (BUSY = HIGH). Used in both parallel and serial interface modes.

Table 4. S35 - Configuration Select Switch Description

Note: (OFF = LOW, ON = HIGH)

Position	Name	Default Position	Function
1	RESET	LOW	Reset ADC: LOW = Enables the converter. HIGH = Abort conversion (if any).
2	PD	LOW	Power down: LOW = Enables the converter . HIGH = Powers down the converter. Power consumption is reduced to a minimum after the current conversion.
3	PDBUF	LOW	Internal reference buffer power down: LOW = Enable on chip buffer. HIGH = Power down internal buffer.
4	PDREF	LOW	Internal reference power down: LOW = Enable on chip reference. HIGH = Power down internal reference. Note that when using the on chip reference, the buffer also needs to be enabled (PDREF = PDBUF = HIGH).

TABLE 5. TEST POINTS

Test Point	Available Signal	Type	Description
TP1	BUSY	Output	BUSY signal.
TP2	A0/M0	Input	Same as S16, position 5
TP3	SIG+	Input	Analog +input.
TP4	AGND	GND	Analog ground close to SIG+.
TP5	REF	Input/Output	Reference input. Output for devices with on-chip reference.
TP7	DGND	GND	Digital ground near SJ2.
TP8	$\overline{\text{CNVST}}$	Input	$\overline{\text{CNVST}}$ signal.
TP9	AGND	GND	Analog ground close to REF.
TP10	$\overline{\text{CS}}$	Input	$\overline{\text{CS}}$, chip select signal.
TP11	$\overline{\text{RD}}$	Input	$\overline{\text{RD}}$, read signal.
TP12	OVDD	Power	Digital output supply.
TP13	DVDD	Power	Digital core supply.
TP14	AVDD	Power	Analog supply.
TP15	AGND	GND	Analog ground close to SIG-.
TP16	SIG-	Input	Analog -input for differential parts.
TP17	SCLK	Input/Output	Buffered serial clock.
TP18	SYNC	Output	Buffered serial sync.
TP19	SDOUT	Output	Buffered serial data.
TP20	TEMP	Output	TEMP, for ADC with internal reference. Outputs temperature dependant voltage (approx. 300mV with $T_A = 25^\circ\text{C}$).
TP22	REFIN	Input/Ouput	For ADCs with internal reference, REFBUFIN can be used to connect external reference into the reference buffer input when PDBUF = LOW and PDREF = HIGH. With the internal reference (and buffer) enabled, this pin will produce the intenal bandgap refrence voltage.
TP23	BVDD	Output	Internal reference bandgap supply. Connected to AVDD via s19.
T3	SDOUT	Output	Direct ADC serial data.
T4	SCLK	Input/Output	Direct ADC serial clock.
T5	SYNC	Output	Direct ADC serial SYNC.
T6	RDERROR	Output	Direct ADC serial read error.

Table 6. Bill of Materials for the Connectors

Ref Des	Connector Type	Manf.	Part No.
J1 – J3	RT Angle SMB Male	Pasternack	PE4177
P2	0.100 X 0.100 straight IDC header 2X20	3M	2540-6002UB
P3	32X3 RT PC MOUNT CONNECTOR	ERNI	533402

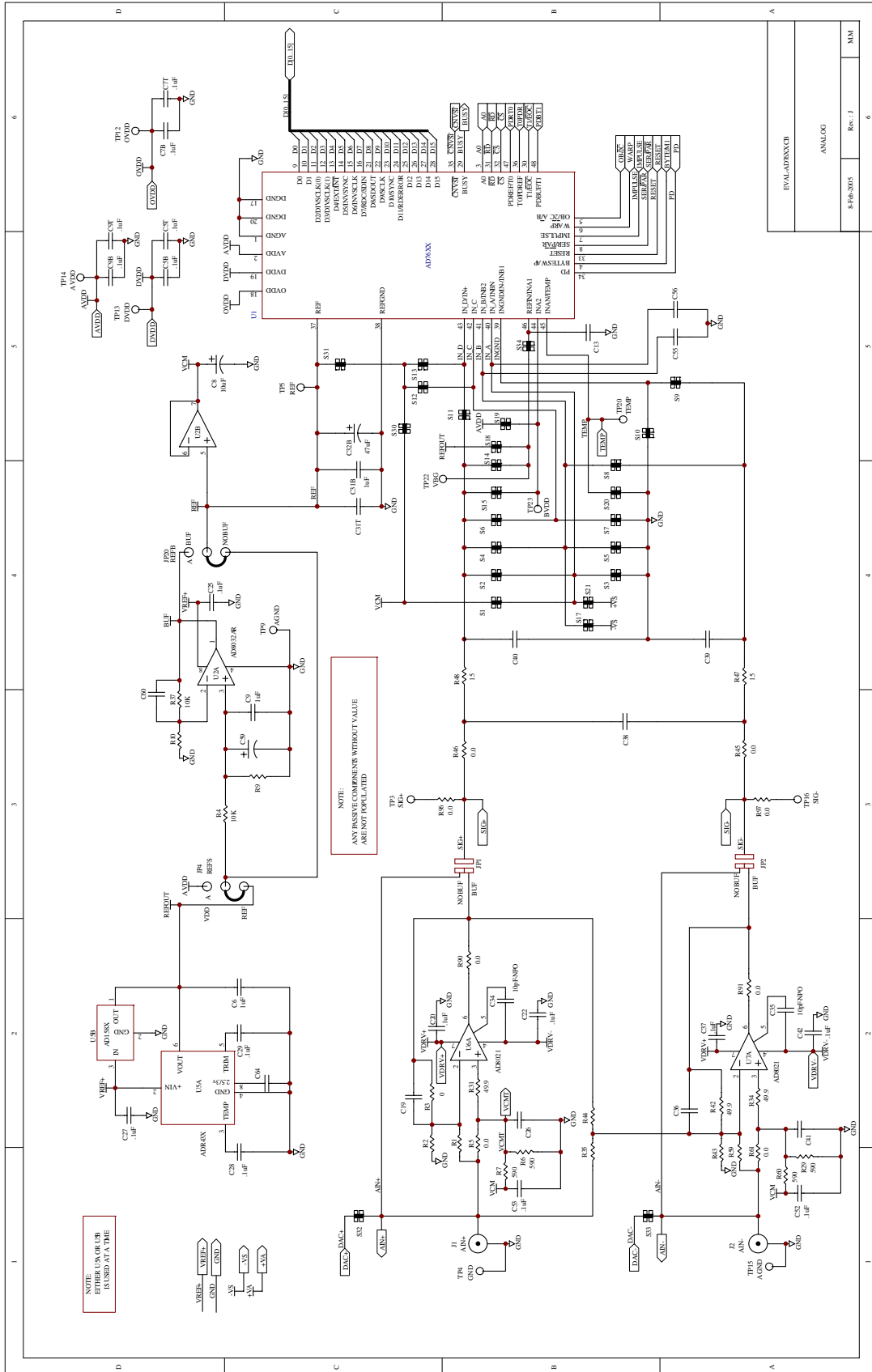

Figure 2. Schematic, Analog

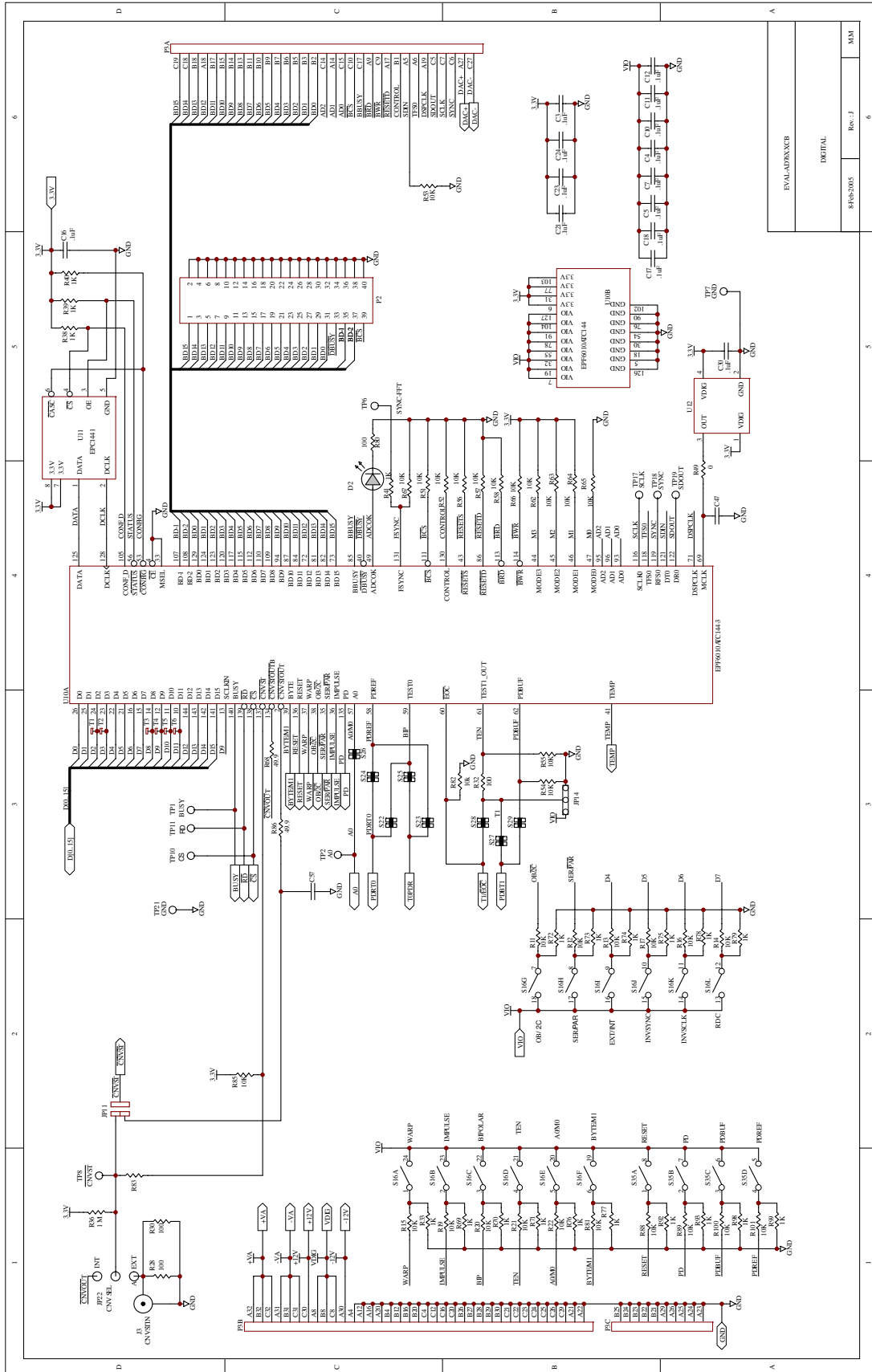

Figure 3. Schematic, Digital

EVAL-AD76XXCBZ
DIGITAL
81682005
Rev. J
6
MM

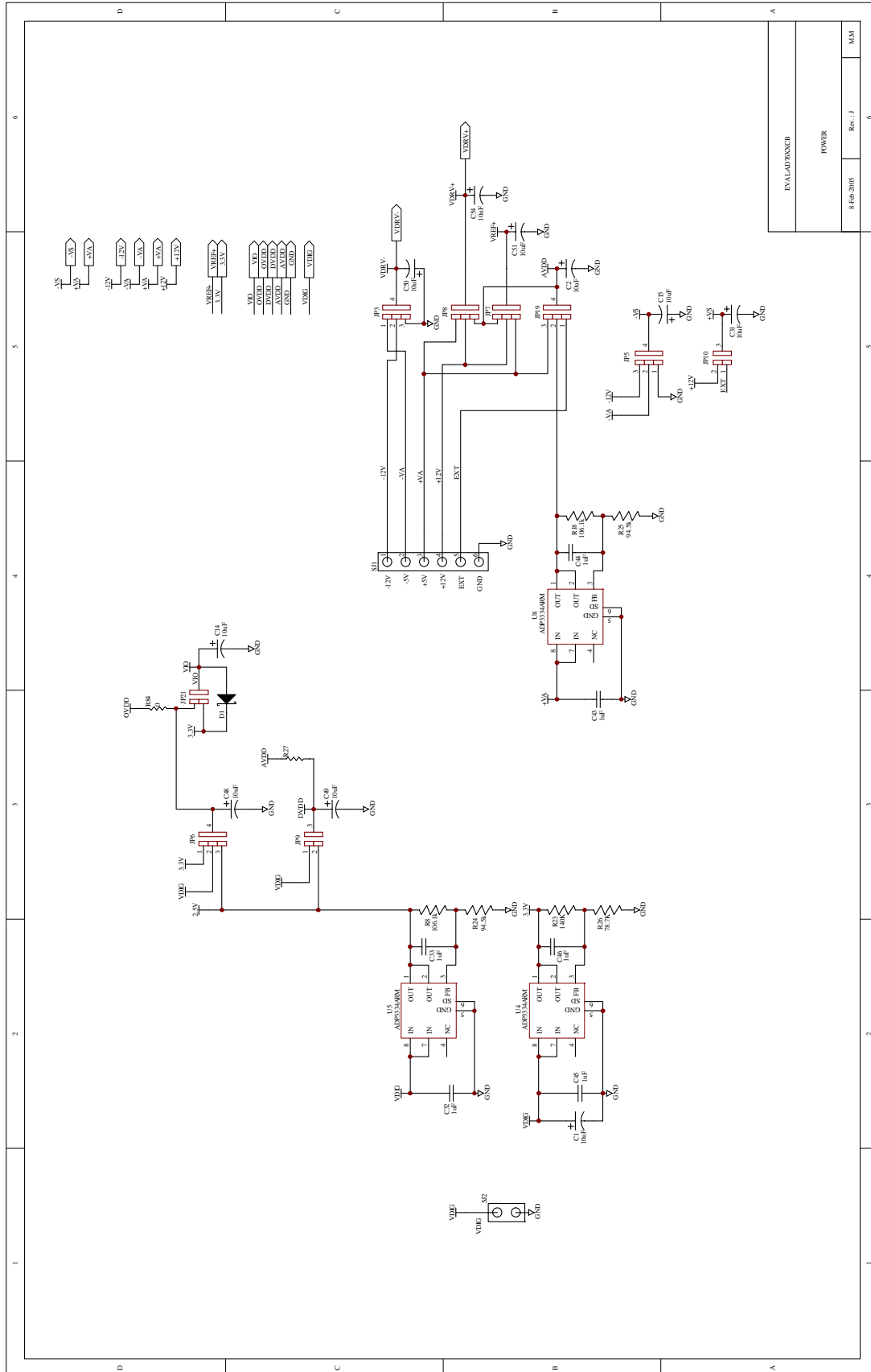

Figure 4. Schematic, Power

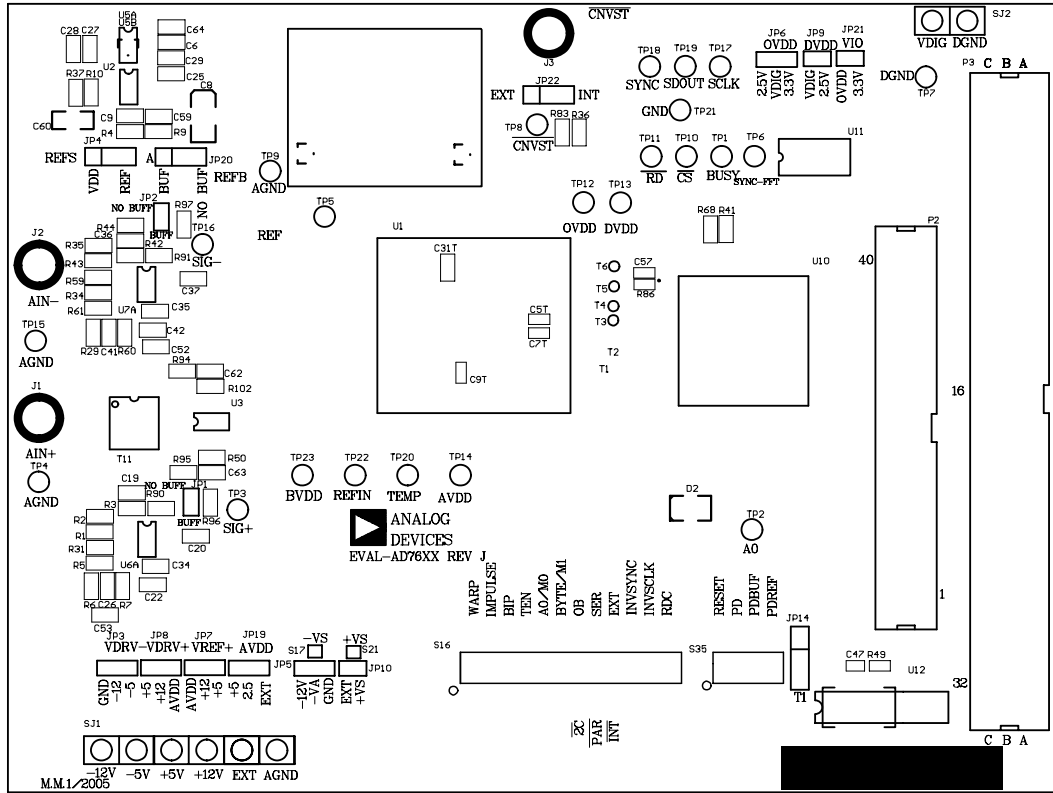

Figure 5. Top Side Silk-Screen

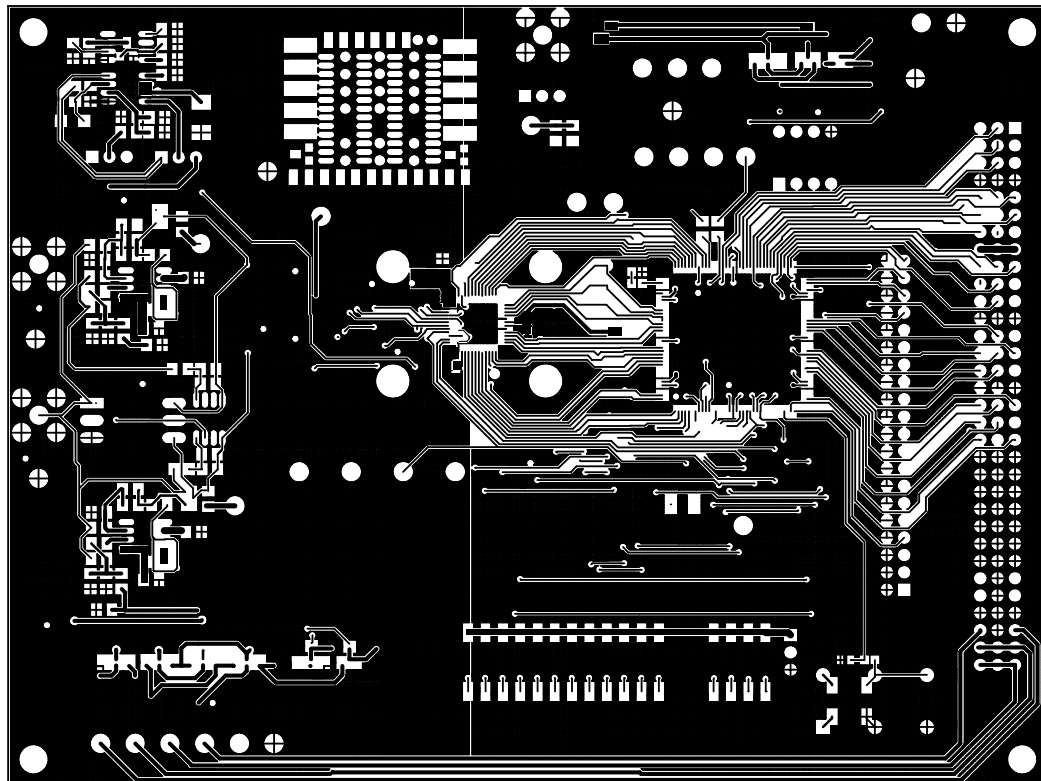

Figure 6. Top Layer

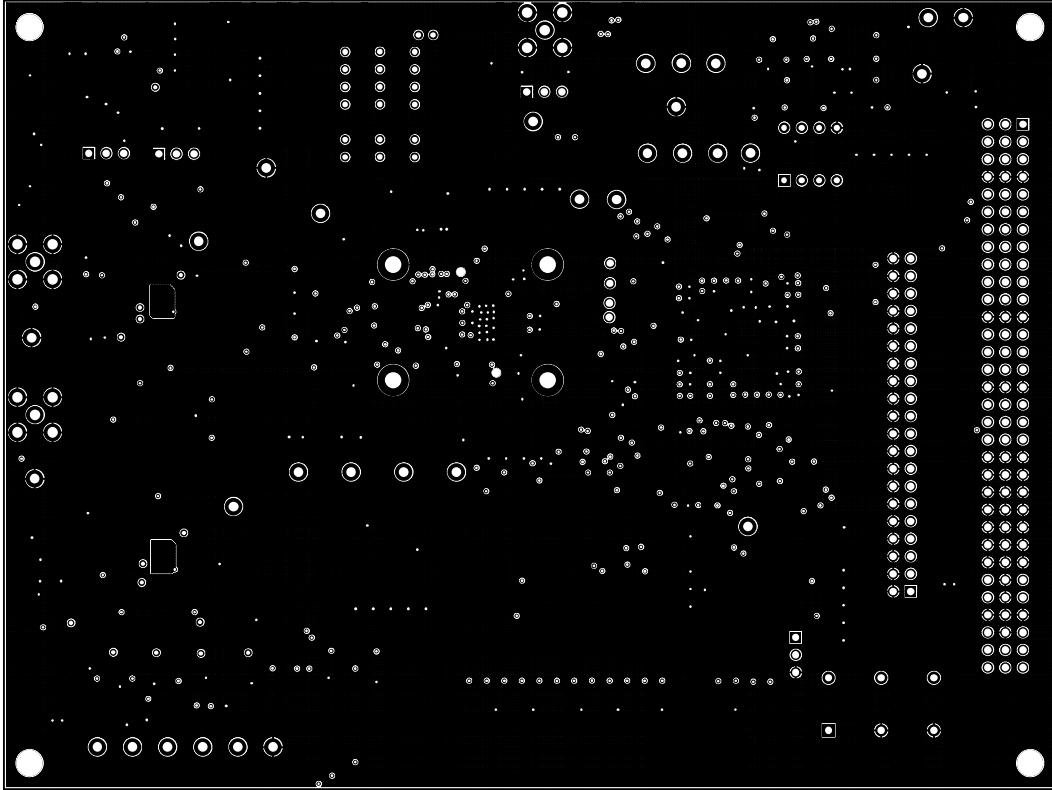

Figure 7. Ground Layer

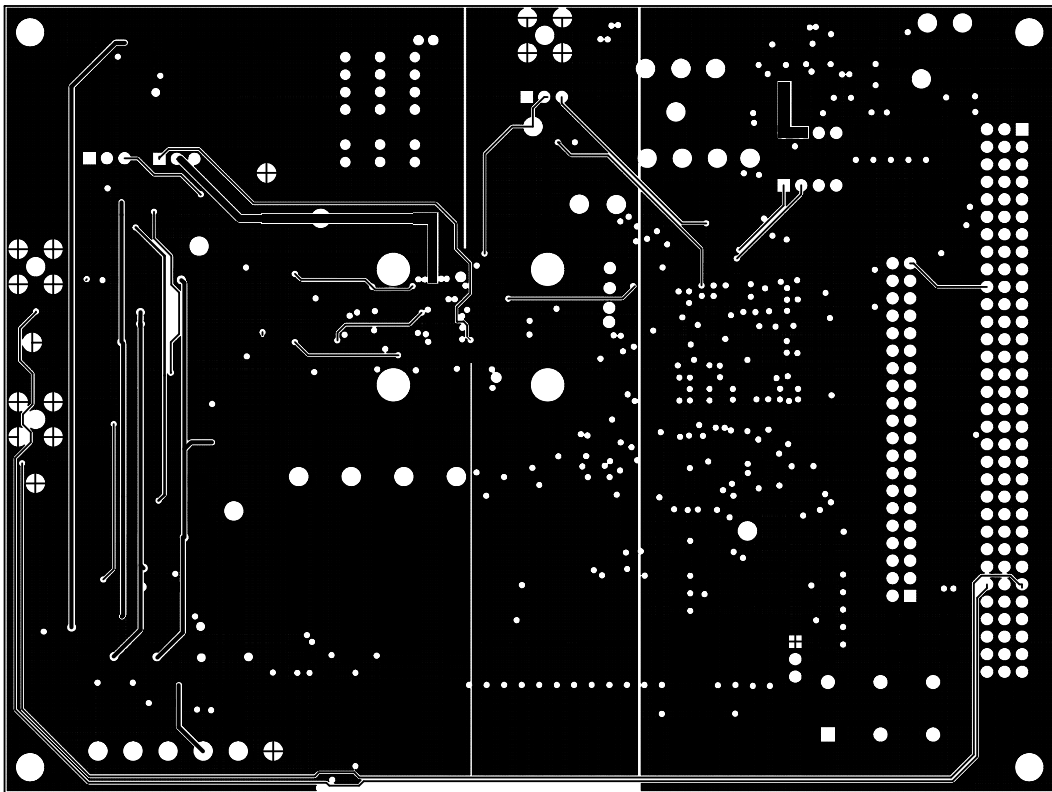

Figure 8. Shield Layer

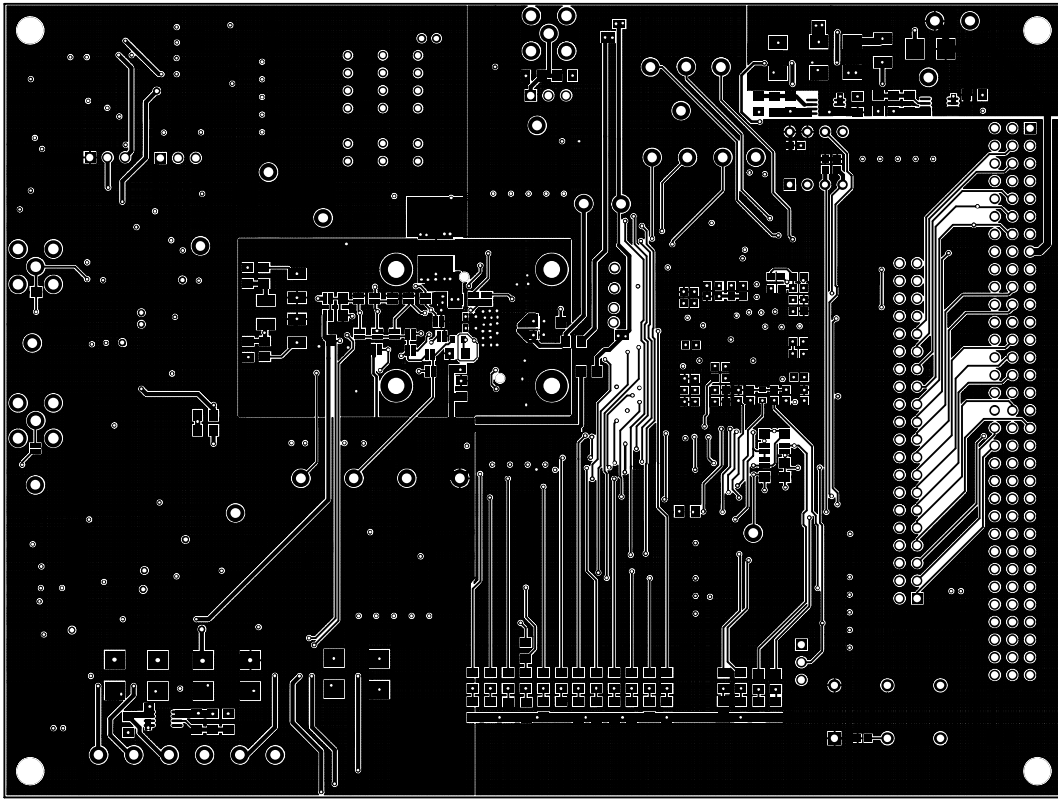

Figure 9. Bottom Side Layer

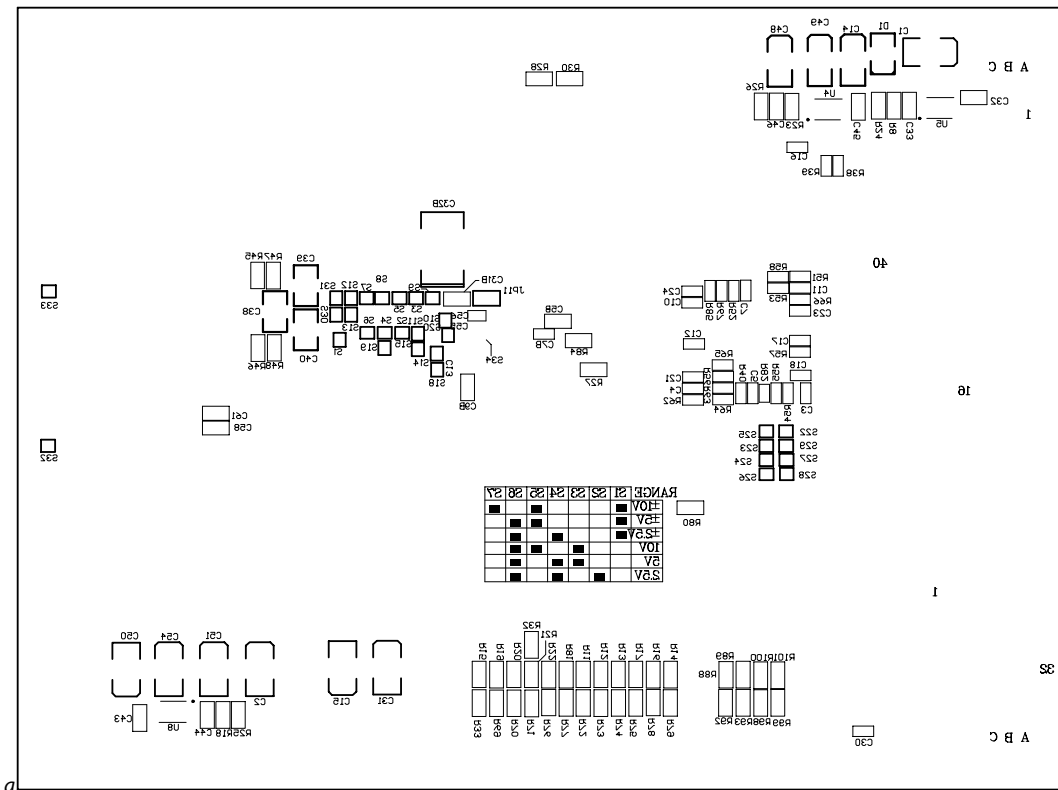

Figure 10. Bottom Side Silk-Screen

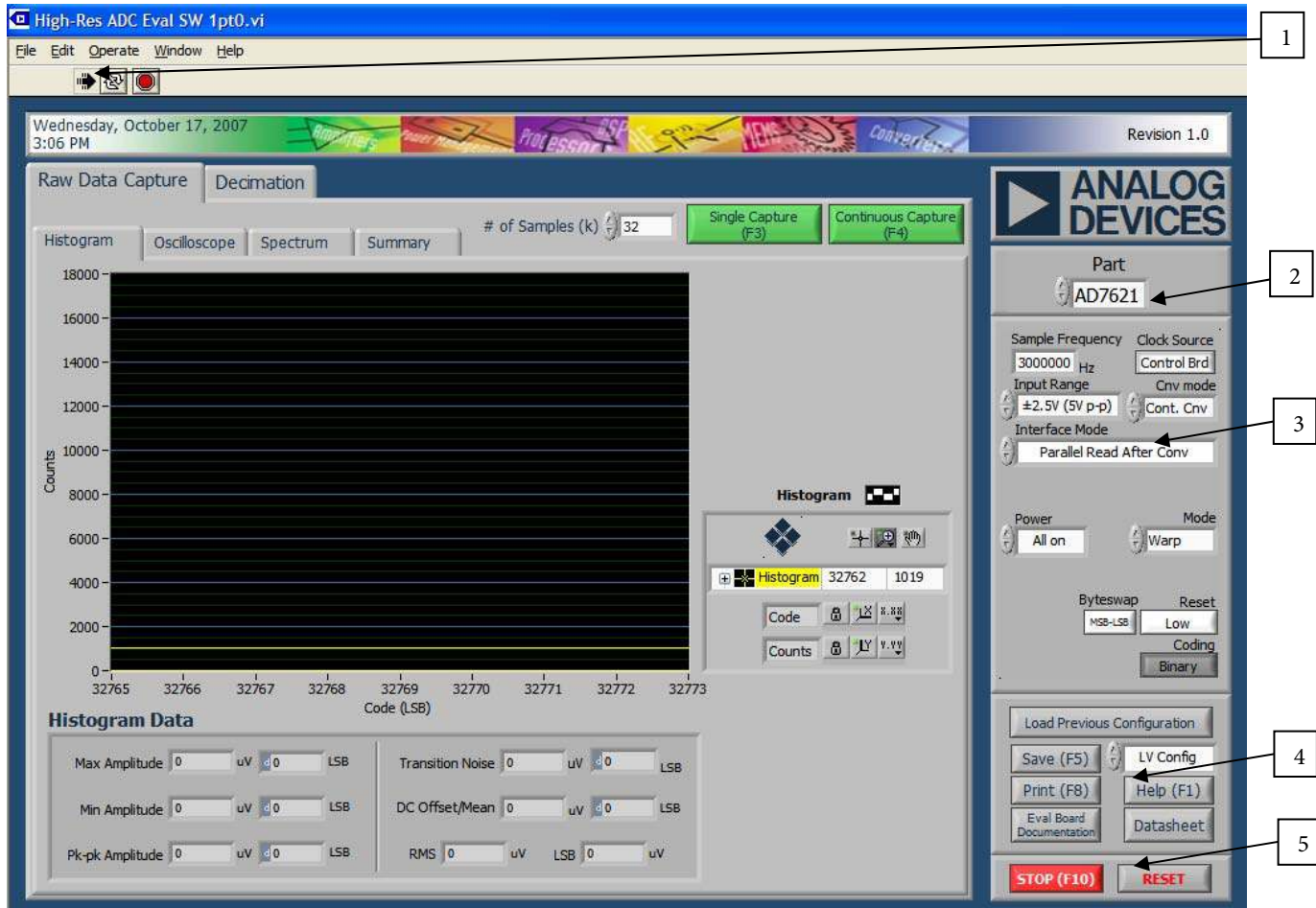



Figure 11. Setup Screen

The following details the operation of the C:\Program Files\Analog Devices\Hi-res ADC's CED x.x\ADC Eval SW CED.exe software.

1. The arrow  is used to start the software. When running  is displayed.

2. The part to be evaluated is selected here.

3. The controls are used to set:

Sample Frequency – units can be used such as 3M (case sensitive) for 3,000,000 Hz.

Clock Source - for FPGA. Selections between capture board or evaluation board.

Cnv Mode – This selects between continuous (Cont.) or Burst conversion modes. In continuous mode, the ADC is continuously converting. In Burst mode, the ADC is not converting (sample clock held in inactive state) and the conversions begin once the “Single Capture” or “Continuous Capture” buttons have been selected.

Interface mode – This selects the digital interface to the on-board FPGA.

Byteswap – A subset of the digital interface mode, this is used to demonstrate byte-wide transfers to the FPGA.

Coding – Another subset to the digital interface mode, this can be used to select straight binary or 2’s complement output.

Power – This can be used to power down the ADC, power down the internal reference, etc.

Mode – This selects the conversion mode of operation.

4. These controls are used for saving, printing, help, etc. and are also accessed in the File menu.

Save (F5): type – LabView config, allows the current configuration to be saved to a *filename.dat* file. Useful when changing many of the default controls. To load the saved configuration, use the Load Previous Configuration.

Type – Html, saves the current screen shot to an Html file.

Type – Spreadsheet, saves the current data displayed in the chart in a tab delimited spreadsheet. Raw ADC Data is time domain in V or Code, FFT or Decimated is in dB.

5. Stop (F10) is used to stop the software. The  can also be used to stop the software. RESET is used to reset the CED or ECB capture boards.

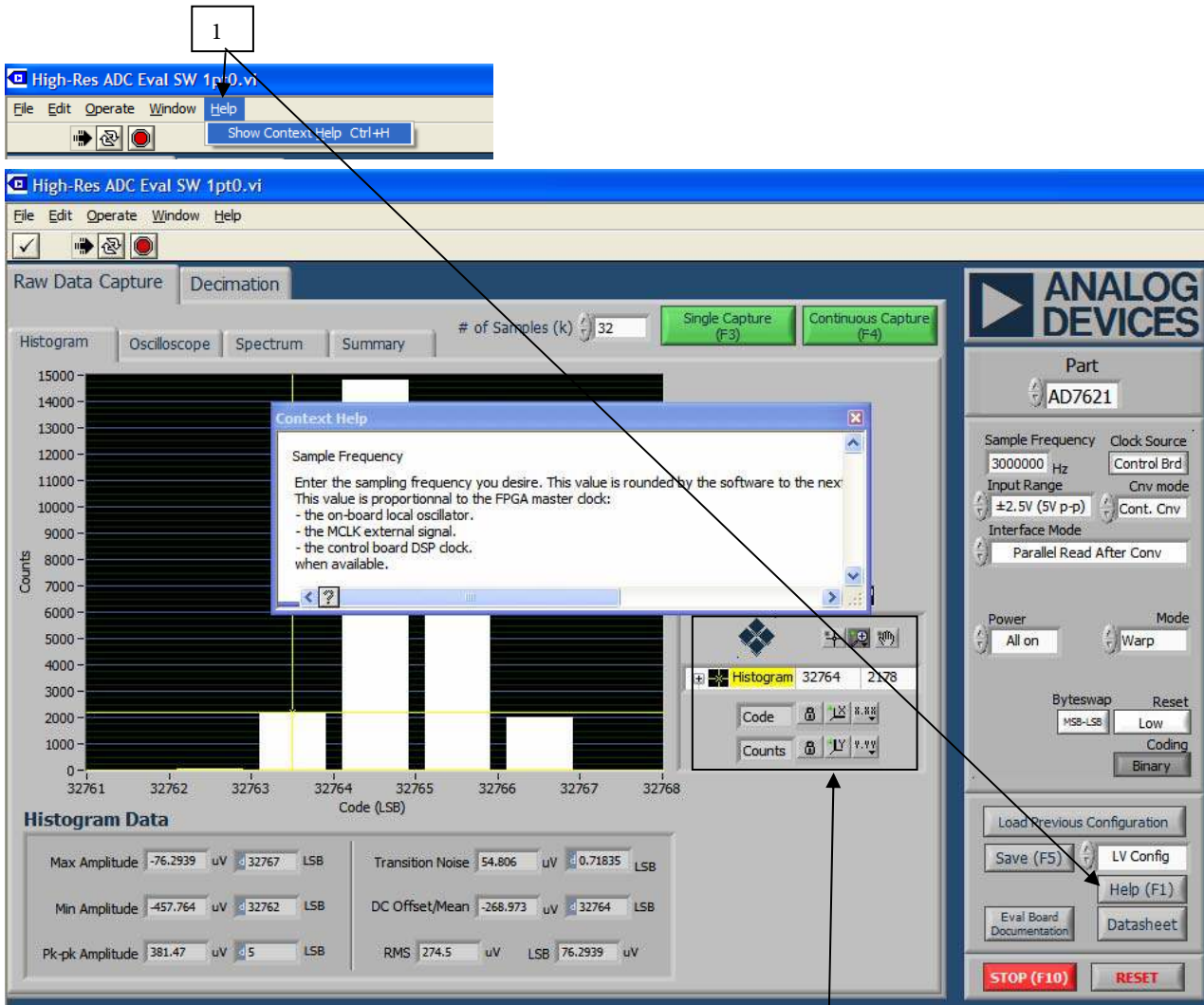







Figure 12. Context Help

1. To use the on-screen help. Select Help, Show Context Help or click the Help (F1). An example of the Context Help is shown above for the Sample Frequency. Placing the cursor on most screen items displays useful help for the particular control or displayed unit.

2. These controls are used for axes and zooming panning.

-  Locks the graph axis to automatically fit the data.
-  Uses last axis set by user. ,  rescale the axes to the automatic values.

,  are used to set axes properties such as format, precision, color, etc.

 Displays the cursor.

 Is used For zooming in and out.

 Is used for panning.

 Is used to set various graph properties such as graph type, colors, lines, etc.

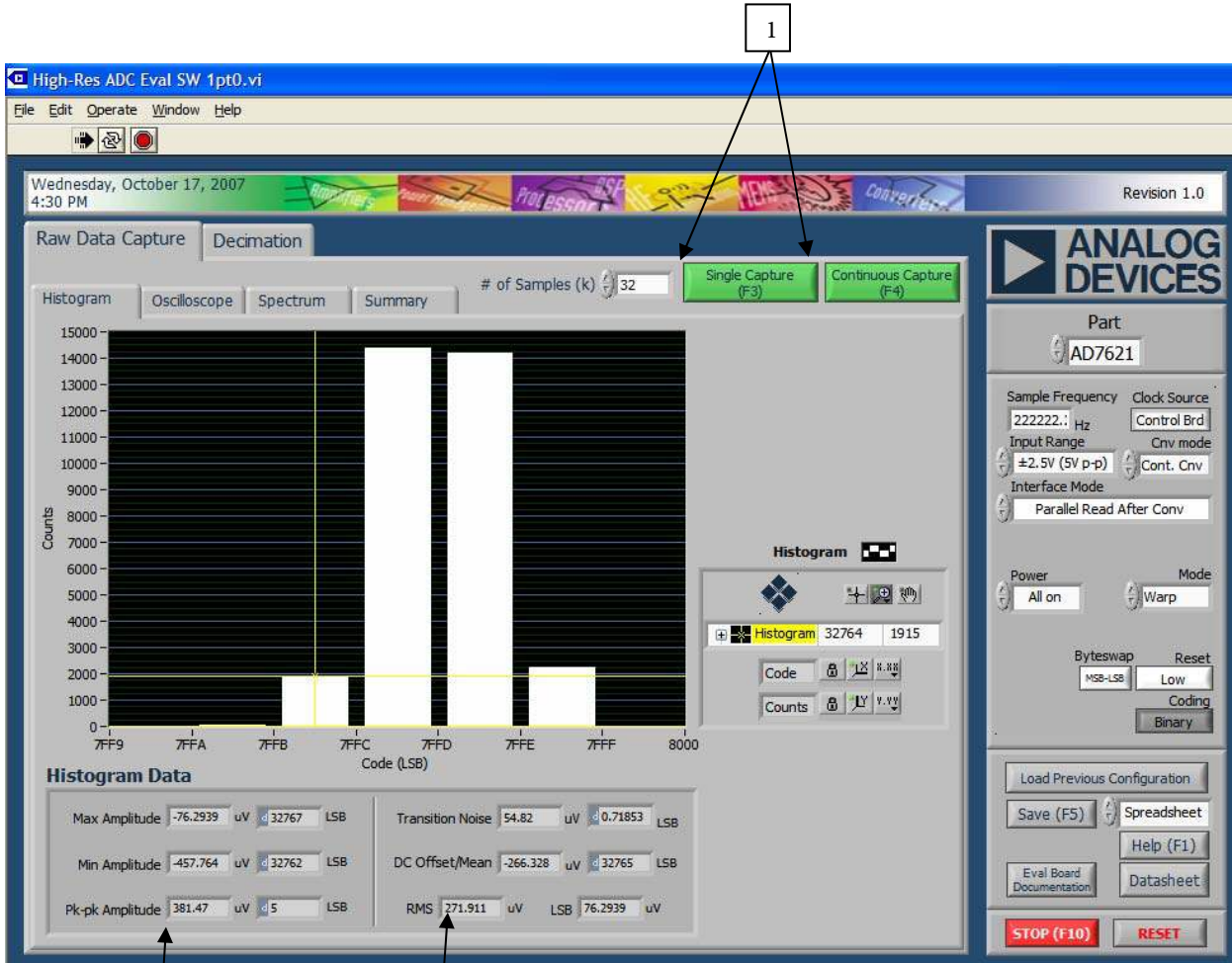
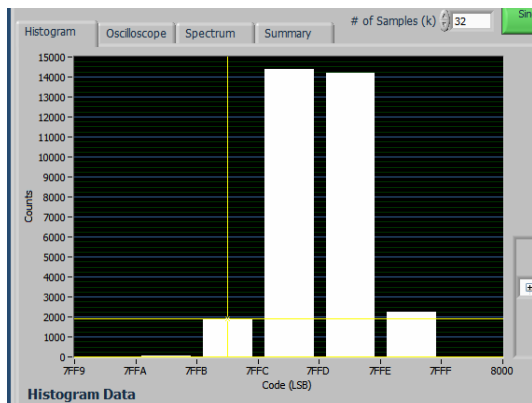
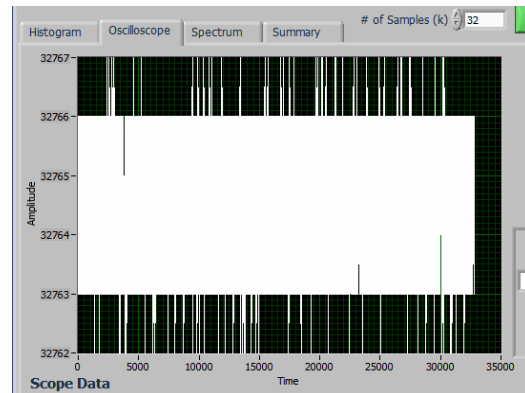

Figure 13. Histogram Screen

1. These radio buttons are used to perform a Single Capture or Continuous Capture of data set in the # of Samples field. The results are displayed in the chart. Note that the results can be displayed as:



A Histogram



Or an Oscilloscope (time domain)

2., 3. These display the statistics for the X and Y-axes, respectively.

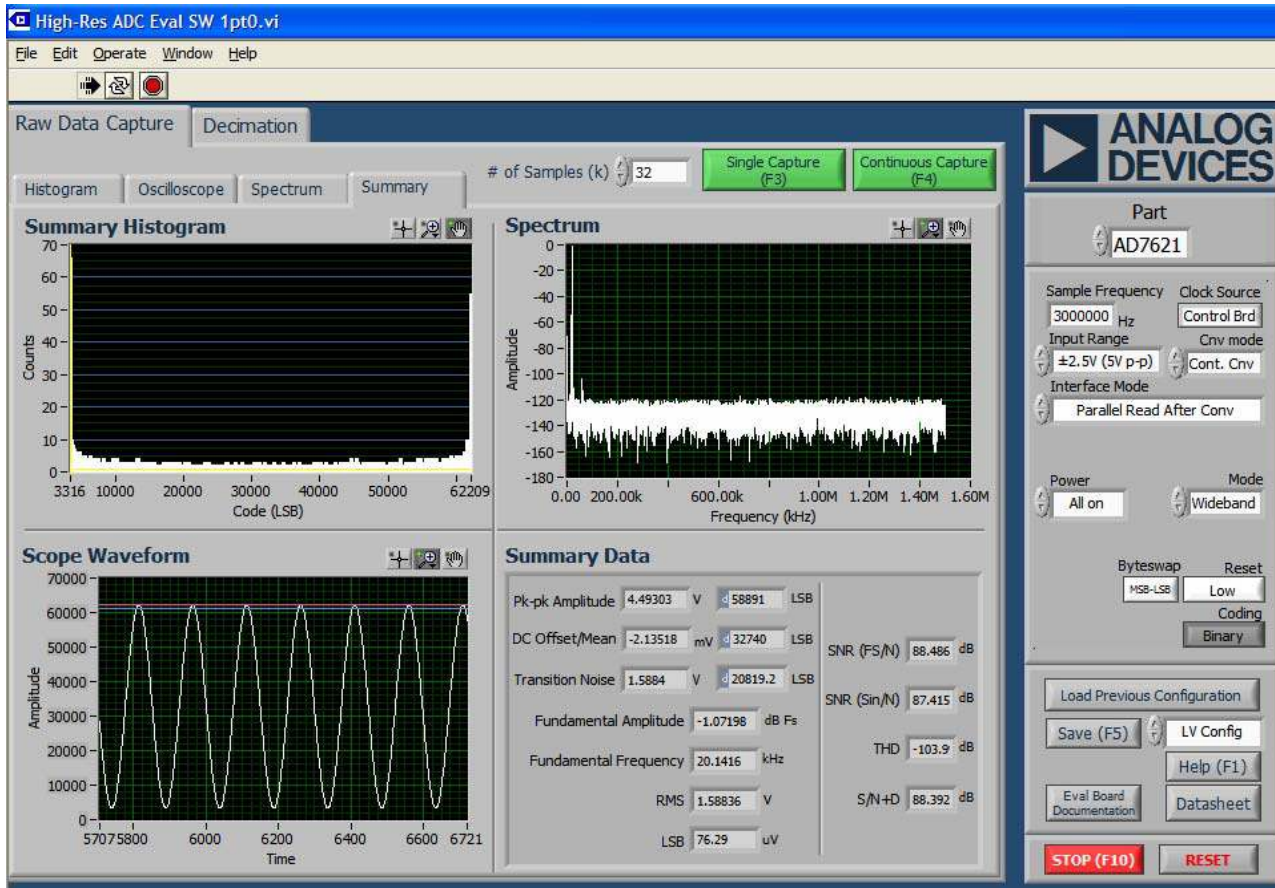

Figure 14. Summary

The charts can be displayed together when the **Summary** tab is selected.

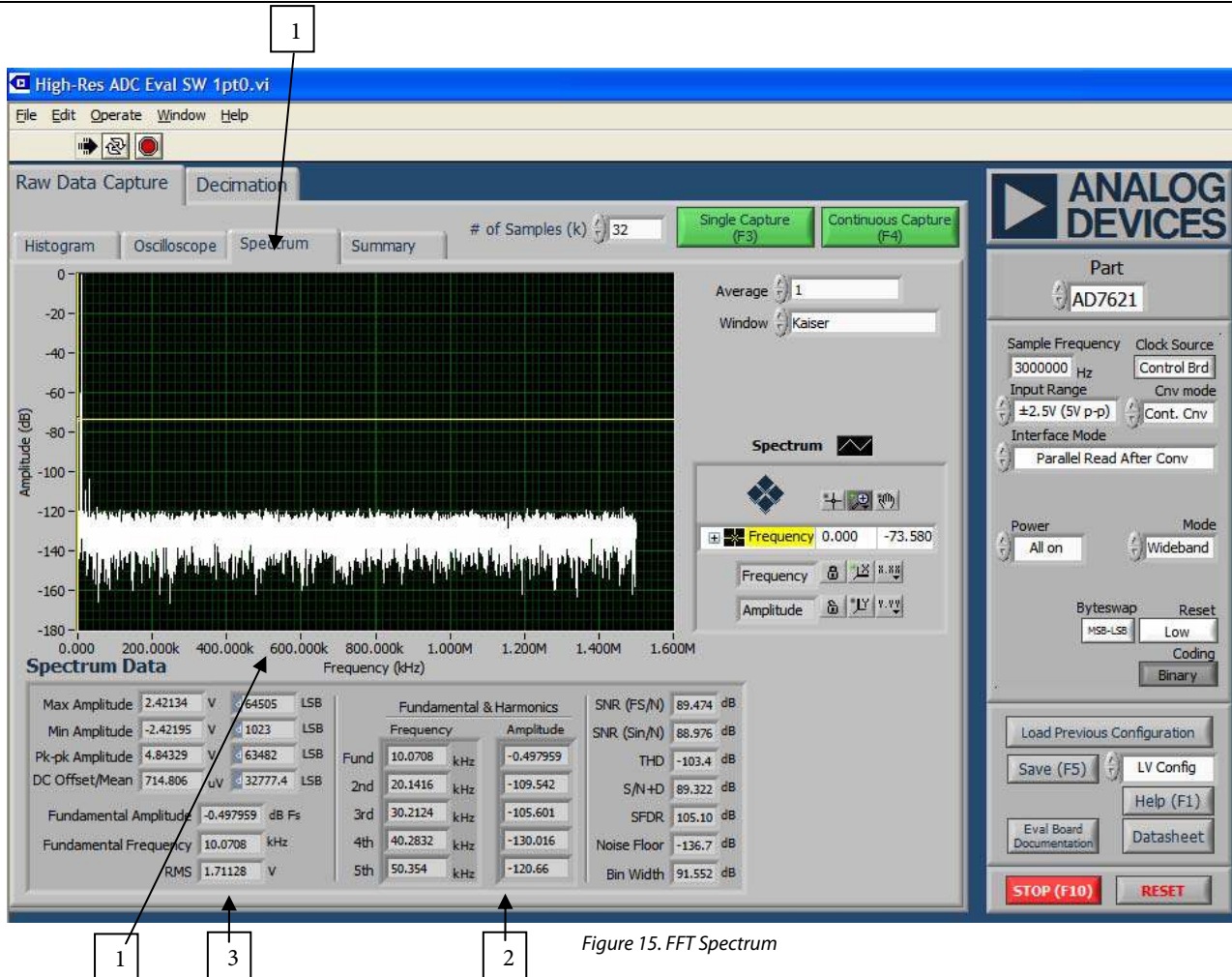

Figure 15. FFT Spectrum

- 1. Displays the FFT when the Spectrum chart is selected
- 2., 3. Display the data for the X and Y-axes, respectively.

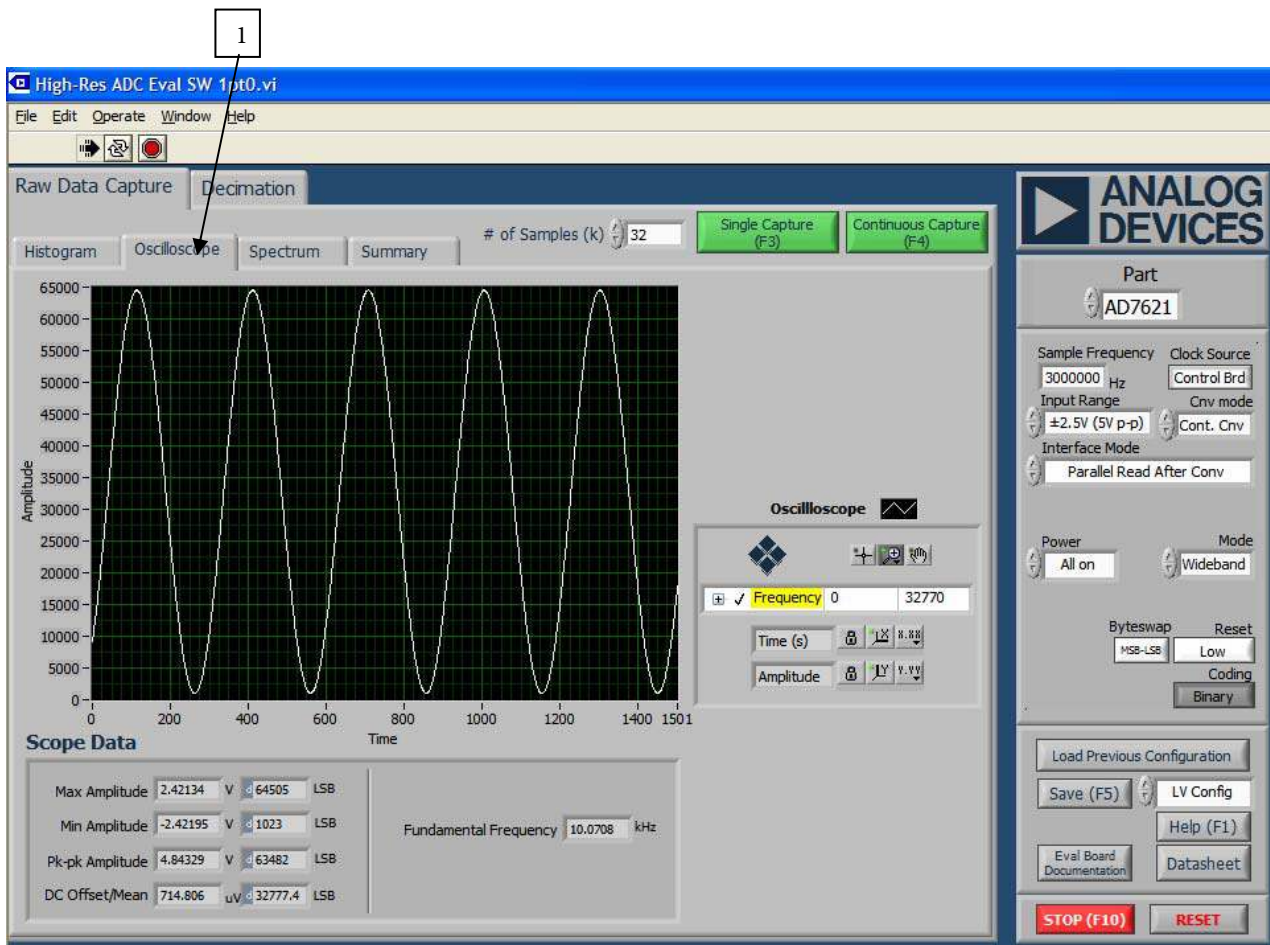

Figure 16. Oscilloscope

1. Time domain data can be viewed with the oscilloscope also.

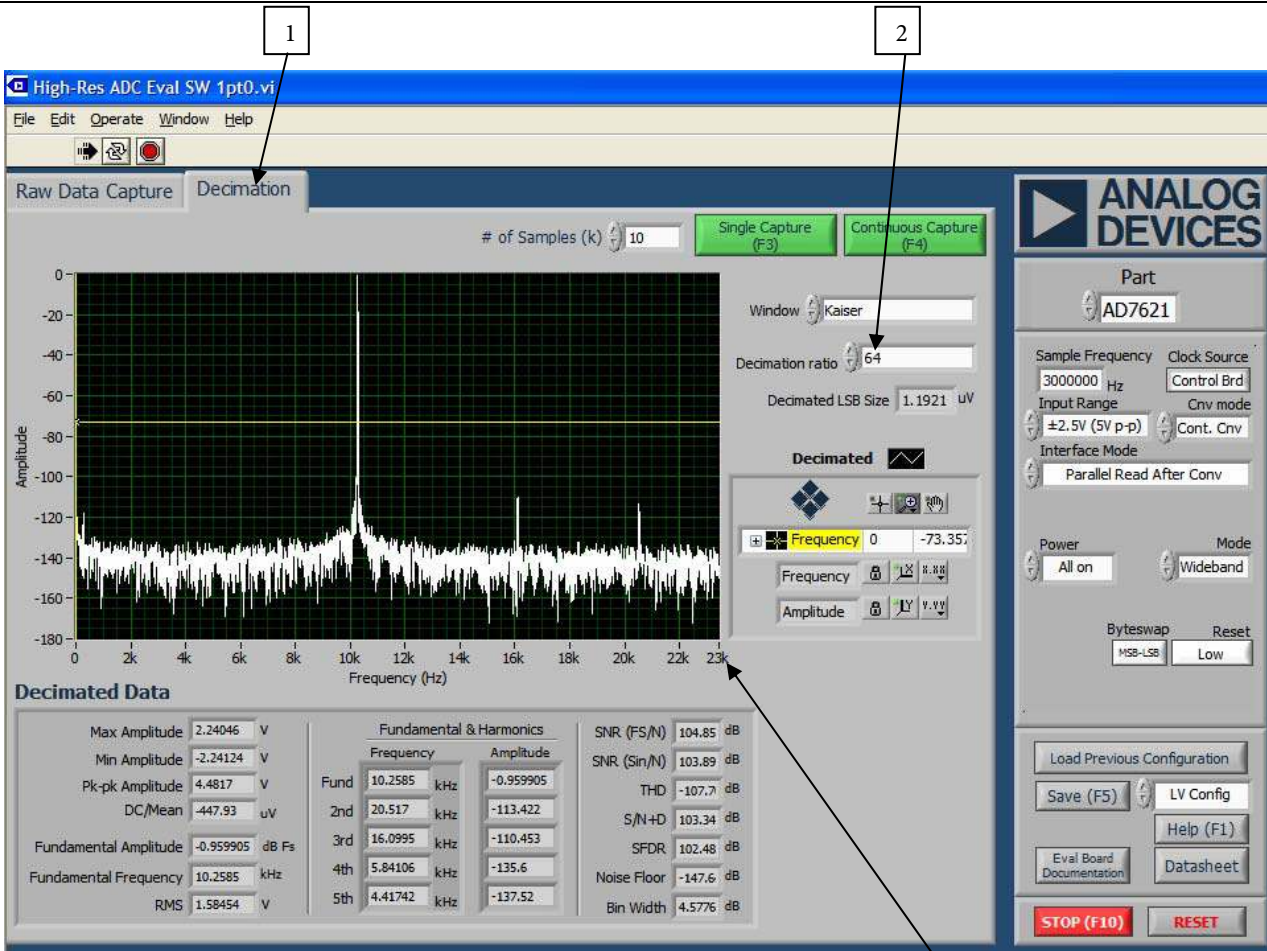

Figure 17 .Decimated FFT

1. As detailed in the Decimated AC Testing section.

2. The Decimation Ratio is the over-sampling ratio. Note that for every power of 4, the effective resolution increases by 6dB or 1 bit (power of 10, increases by 10dB).

3. The Nyquist frequency is displayed as:

$$F_{NYQUIST} = \frac{SampleFrequency}{2 * DecimationRatio}$$

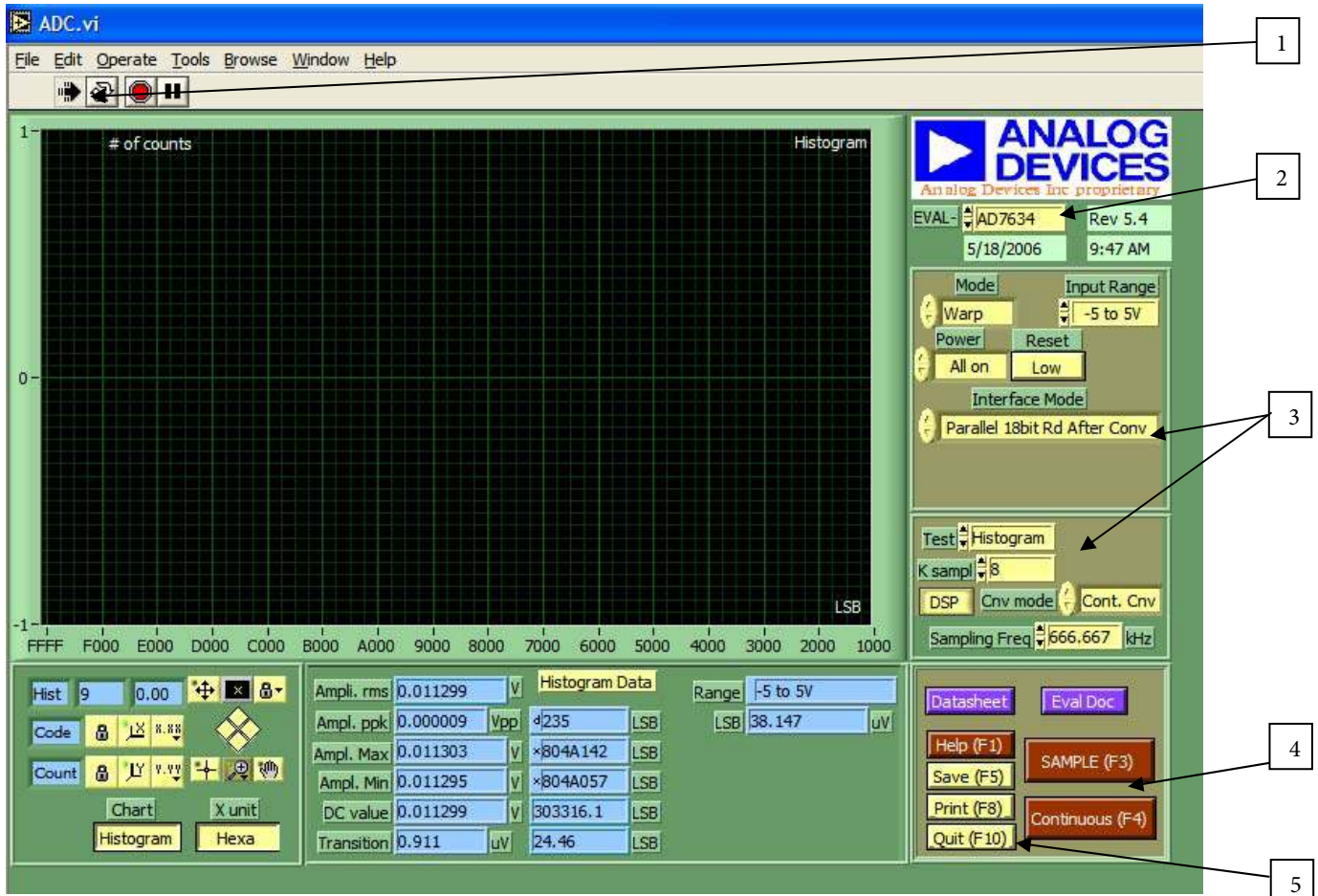



Figure 18. Setup Screen

The following details the operation of the C:\Program Files\Analog Devices\Hi-res ADC's x.x\ADC.exe software.

1. The arrow  is used to start the software. When running  is displayed.

2. The part to be evaluated is selected here.

3. The controls are used to set:

Sampling Frequency – Slect the up/down arrows or enter a value (which will be rounded).

 **Clock Source** - for FPGA. Selections between DSP capture board or local to the evaluation board.

Cnv Mode – This selects between continuous (Cont.) or Burst conversion modes. In continuous mode, the ADC is continuously converting. In Burst mode, the ADC is not converting (sample clock held in inactive state) and the conversions begin once the “Single Capture” or “Continuous Capture” buttons have been selected.

Interface mode – This selects the digital interface to the on-board FPGA.

Byteswap – A subset of the digital interface mode, this is used to demonstrate byte-wide transfers to the FPGA.

Coding – Another subset to the digital interface mode, this can be used to select straight binary or 2’s complement output.

Power – This can be used to power down the ADC, power down the internal reference, etc.

Mode – This selects the conversion mode of operation.

Test – Selection between Histogram, AC or Decimated.

K samples – Number of samples (conversions) to capture.

4. These controls are used for sampling, saving, printing, help, quite, etc. and are also accessed in the File menu.

Sample (F3) – Captures the amount of k samples and display on the chart

Contionuous (F4) – Continuously sample and update chart.

Save (F5): – Saves the current data displayed in a text file of row format.

5. Quite (F10) is used to stops the software. The  can also be used to stop the software.

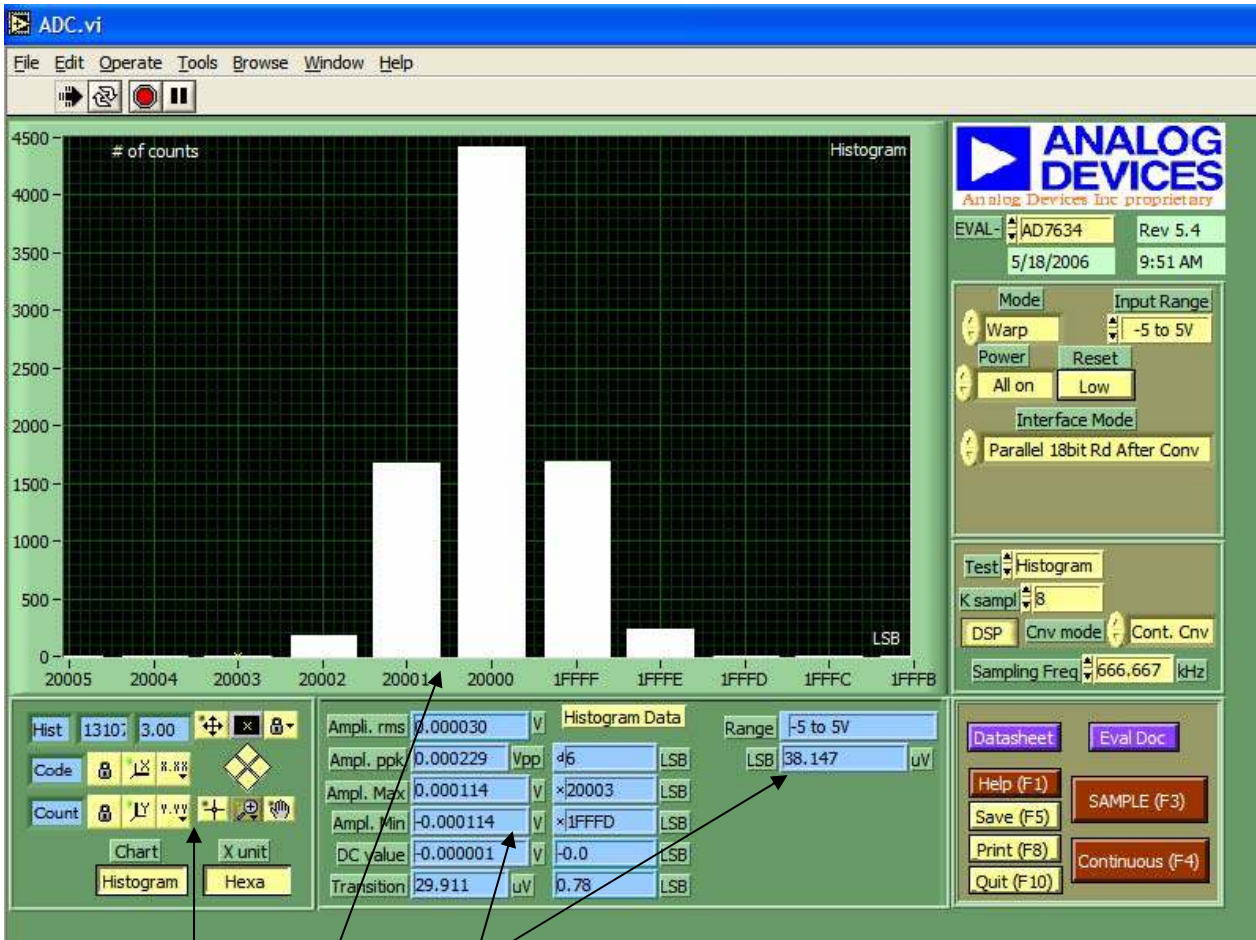

Figure 19. Histogram Screen

3
1
2

1. The results are displayed in this chart. Also, the cursor (yellow) can be dragged it to a desired location where the X-axis values and the Y-axis value will be displayed.

2. Different measurements are displayed here. The DC value, Transition Noise and other values such as the ADC range and LSB value in Volts.

3. These controls are used for axes and zooming panning.

- Locks the graph axis to automatically fit the data.
- Uses last axis set by user. , rescale the axes to the automatic values.
- , are used to set axes properties such as format, precision, color, etc.

- Displays the cursor.
- Is used For zooming in and out.
- Is used for panning.
- Is used to set various graph properties such as graph type, colors, lines, etc.
- These control the choice of chart type and X-units. Chart type selection of Histogram or Time and X-units of hexadecimal or Volts.

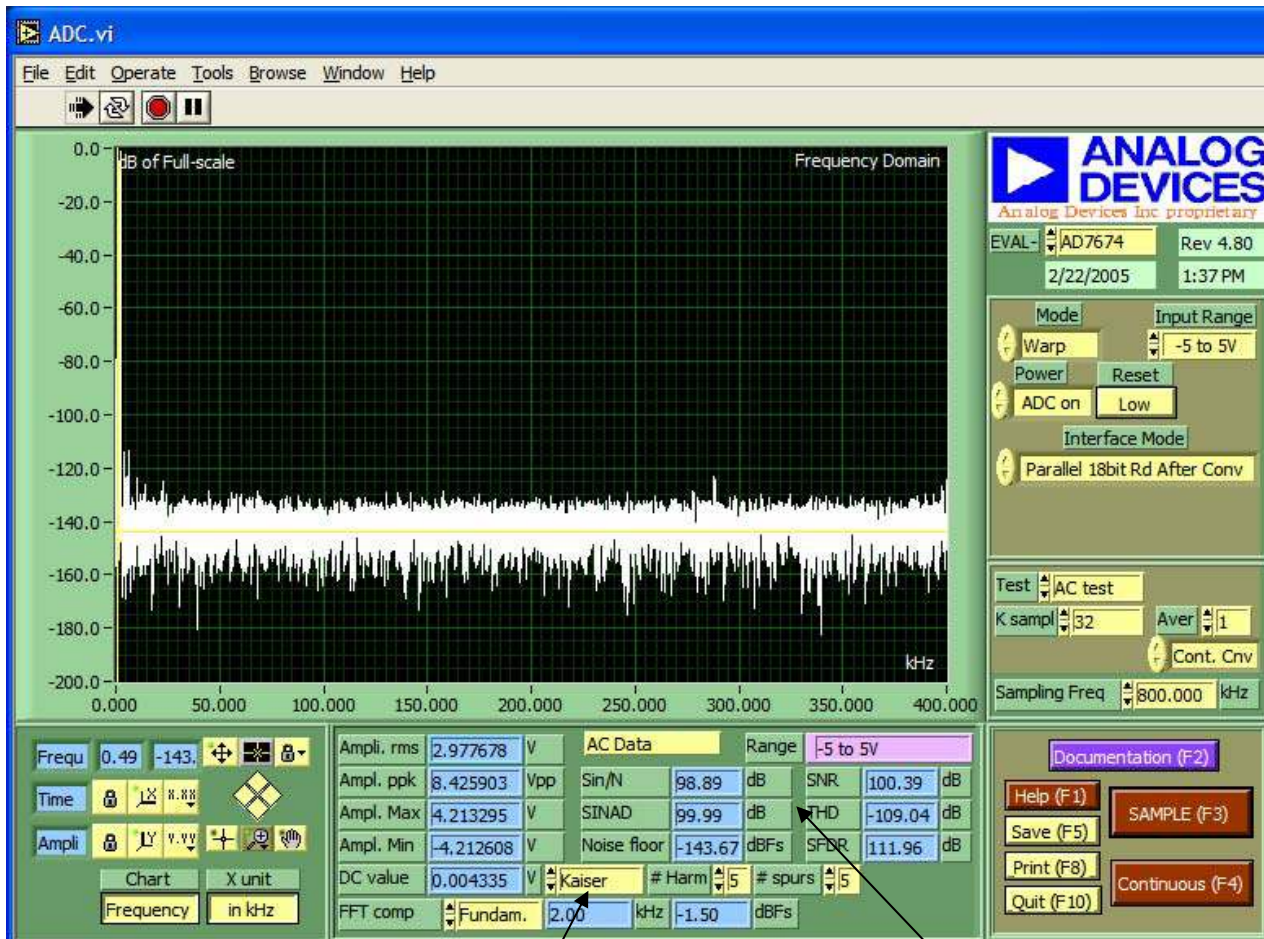

1 Figure 20. FFT Screen 2

1. AC test results are displayed here. Also the choice of viewing the amplitude of a certain FFT component can be selected from the FFT component menu.
2. Choice of either a Kaiser window or a Blackmann-Harris window from the is menu.

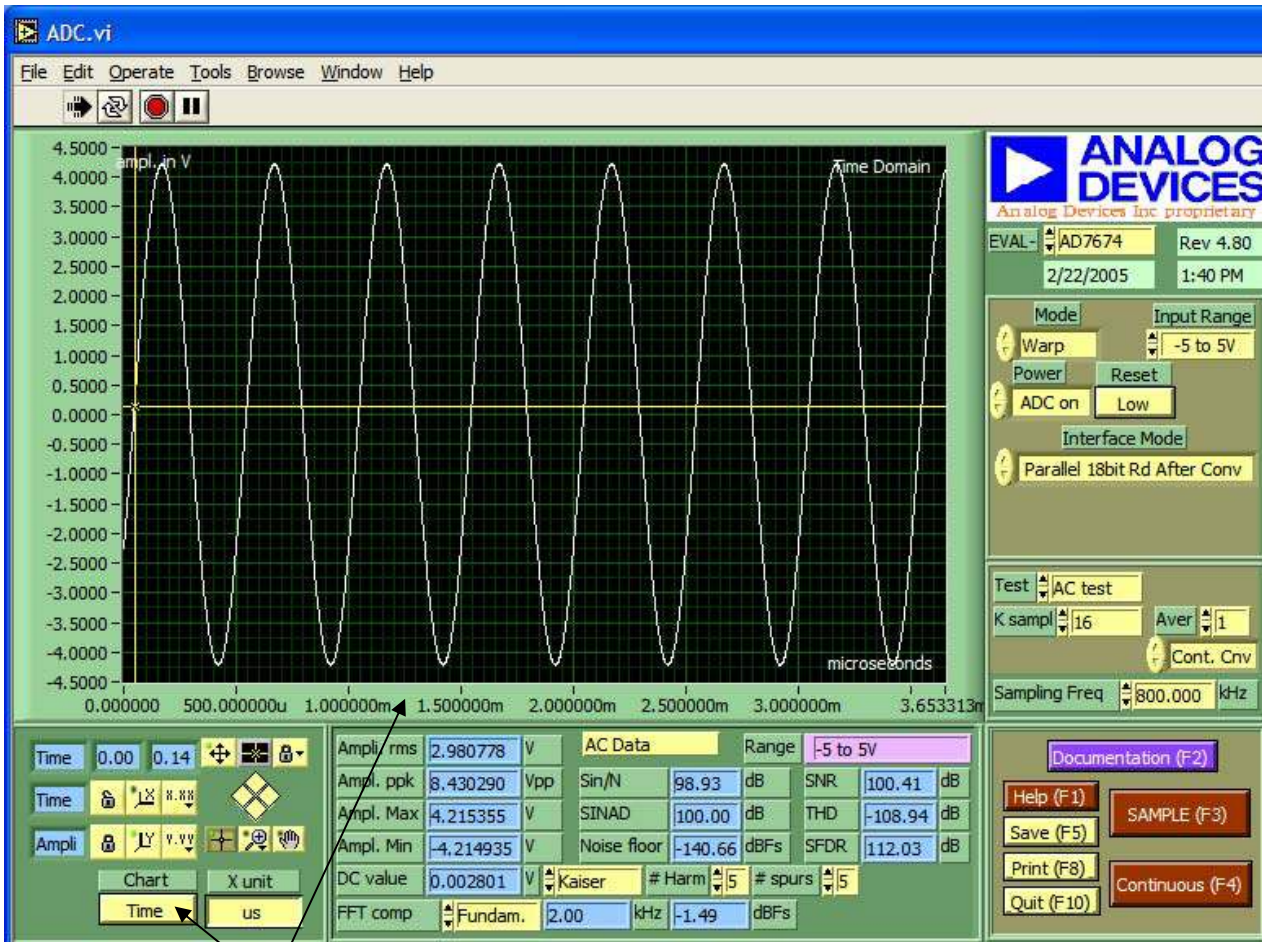

Figure 21. Time-Domain Screen

1

1. The AC test can also be displayed in the Time Domain. To view the Time domain output, select Time in this menu.

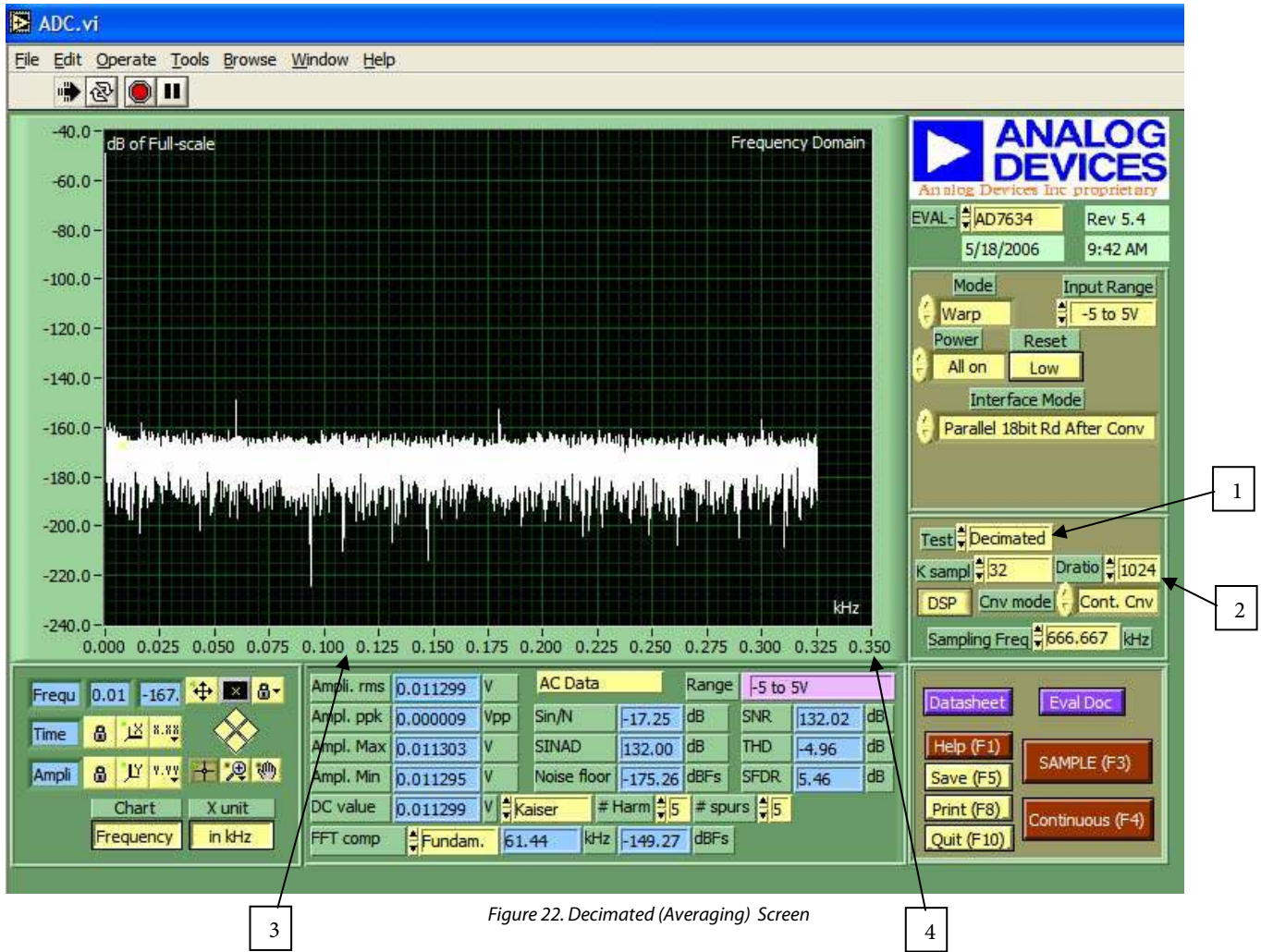

Figure 22. Decimated (Averaging) Screen

1. As detailed in the Decimated AC Testing section.

2. The decimation ratio (Dratio) and number of Ksamples are entered here. The decimation ratio is the over-sampling ratio. Note that for every power of 4, the effective resolution increases by 6dB or 1 bit (power of 10, increases by 10dB).

3. AC test results with decimated averaging are shown here. The SNR indicator also represents the dynamic range when no signal is present.

4. The Nyquist frequency is displayed as:

$$F_{\text{NYQUIST}} = \frac{F_{\text{SAMPLE}}}{2 \times D_{\text{RATIO}}}$$

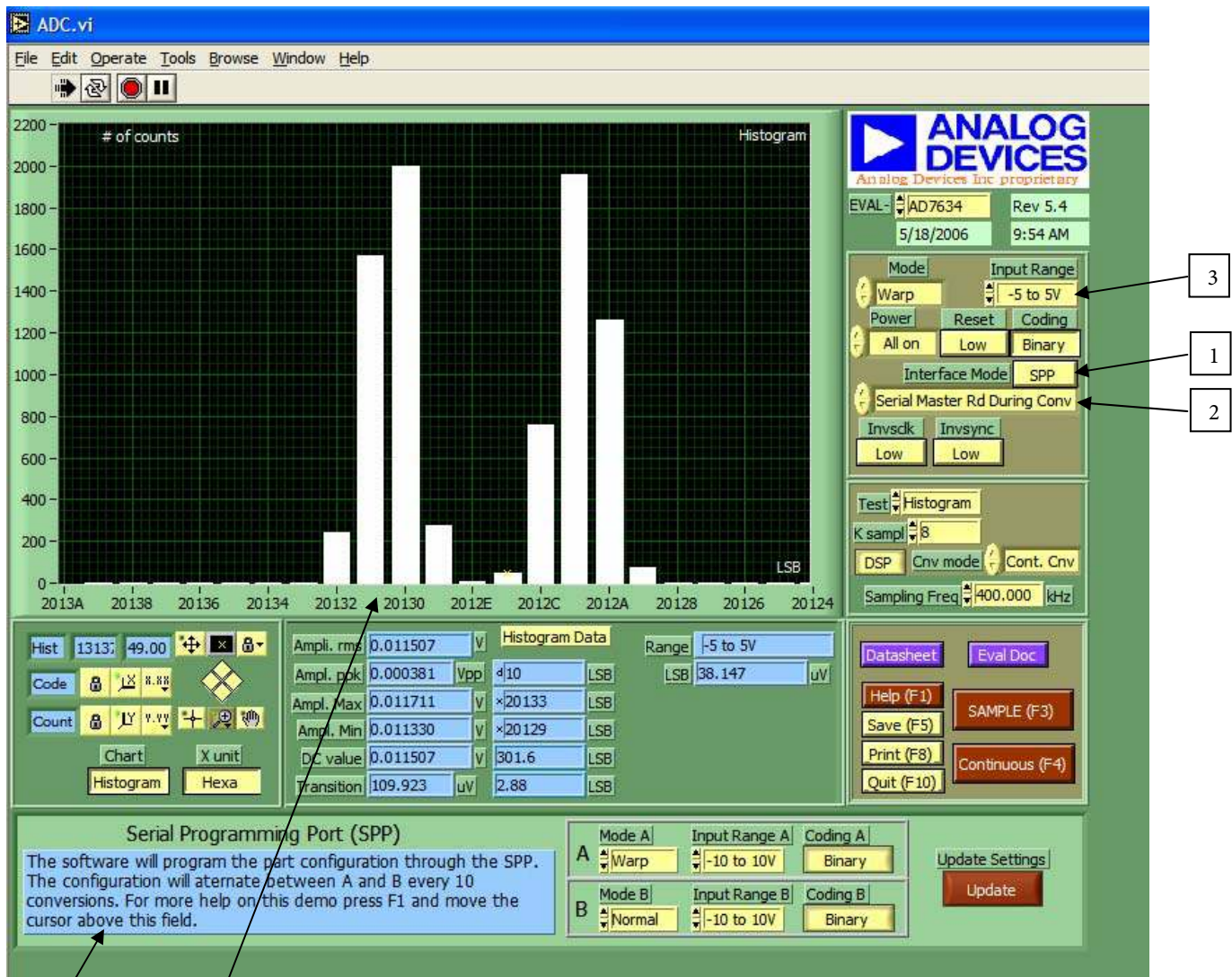

Figure 23. Serial Programmable Port (SPP) Screen (AD7610/7612/7631/7634/7951/7952 only)

1. This selects the Serial Programmable Port
2. This selects the interface mode. Any of the four serial modes can be used to program the ADC through the Serial Programmable Port
3. This selects the input range configured through the Serial Programmable Port (SPP) or hardware pins.
4. As per this informative description, the software will collect data every ten samples from the two sets of data entered in the

5. The results are displayed here for the two different configurations. This particular example is showing the bipolar zero error difference between Warp and Normal modes.

ORDERING GUIDE

Evaluation Board Model	Product
EVAL-AD7610CBZ	AD7610ASTZ/ACPZ
EVAL-AD7612CBZ	AD7612ASTZ/ACPZ
EVAL-AD7621CBZ	AD7621ASTZ/ACPZ
EVAL-AD7622CBZ	AD7622BSTZ/BCPZ
EVAL-AD7623CBZ	AD7623ASTZ/ACPZ
EVAL-AD7631CBZ	AD7631ASTZ/ACPZ
EVAL-AD7634CBZ	AD7634ASTZ/ACPZ
EVAL-AD7641CBZ	AD7641BSTZ/BCPZ
EVAL-AD7643CBZ	AD7643BSTZ/BCPZ
EVAL-AD7650CBZ	AD7650ASTZ/ACPZ
EVAL-AD7651CBZ	AD7651ASTZ/ACPZ
EVAL-AD7652CBZ	AD7652ASTZ/ACPZ
EVAL-AD7653CBZ	AD7653ASTZ/ACPZ
EVAL-AD7654CBZ	AD7654ASTZ/ACPZ
EVAL-AD7655CBZ	AD7655ASTZ/ACPZ
EVAL-AD7660CBZ	AD7660ASTZ/ACPZ
EVAL-AD7661CBZ	AD7661ASTZ/ACPZ
EVAL-AD7663CBZ	AD7663ASTZ/ACPZ
EVAL-AD7664CBZ	AD7664ASTZ/ACPZ
EVAL-AD7665CBZ	AD7665ASTZ/ACPZ
EVAL-AD7666CBZ	AD7666ASTZ/ACPZ
EVAL-AD7667CBZ	AD7667ASTZ/ACPZ
EVAL-AD7671CBZ	AD7671ASTZ/ACPZ
EVAL-AD7674CBZ	AD7674ASTZ/ACPZ
EVAL-AD7675CBZ	AD7675ASTZ/ACPZ
EVAL-AD7676CBZ	AD7676ASTZ/ACPZ
EVAL-AD7677CBZ	AD7677ASTZ/ACPZ
EVAL-AD7678CBZ	AD7678ASTZ/ACPZ
EVAL-AD7679CBZ	AD7679ASTZ/ACPZ
EVAL-AD7951CBZ	AD7951ASTZ/ACPZ
EVAL-AD7952CBZ	AD7951ASTZ/ACPZ
EVAL-CED1Z	USB Capture Board
EVAL-CONTROL BRD2Z ¹	Parallel Port Capture Board
EVAL-CONTROL BRD3Z	Parallel Port Capture Board

¹ Not in production any longer.

NOTES