

Maswell 5G/4G/LTE+GNSS Panel MIMO Combo Antenna

AN_Master_001-4

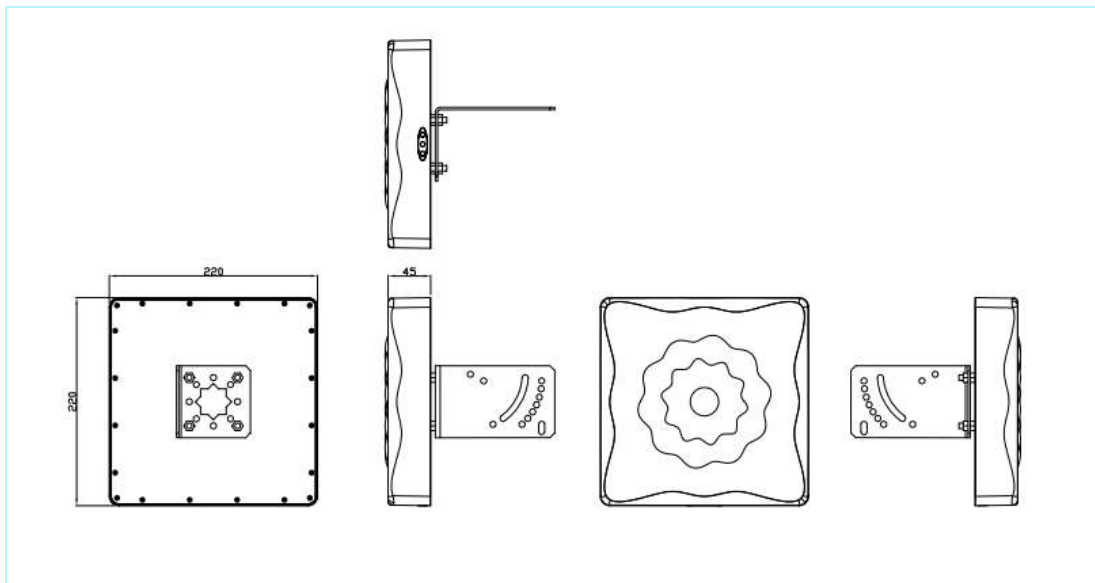

Mechanical dimension



Maswell 5G/4G/LTE+GNSS Panel MIMO Combo Antenna

AN_Master_001-4

Specifications

Item		Specifications	
GNSS Antenna (GPS/GLONASS/ Beidou/Gaileo)	Dielectric Antenna	Center Frequency	1561.098~1602MHz
		Polarization	RHCP
		Gain	5dBic@PCB (Zenith)
		V.S.W.R	< 1.5
		Impedance	50Ω
		Axial Ratio	3dB(max)
	LNA	Gain	28±2dB
		Noise Figure	≤1.5dB
		Filter Insertion Loss	< 3dB
		Supply Voltage	3~5V DC
		Current Consumption	< 20mA
	V.S.W.R	< 2.0	
Antenna 1 (Main)		Frequency Range	600-8000MHz
		Polarization	Linear (+45°)
		Gain	6.9dBi (Maximum)
		V.S.W.R	< 2.0
		Impedance	50Ω
		Isolation	15dB
Antenna 2 (AUX)		Frequency Range	600-8000MHz
		Polarization	Linear (-45°)
		Gain	7.5dBi (Maximum)
		V.S.W.R	< 2.0
		Impedance	50Ω
		Isolation	15dB
Mechanical		Dimension	22cm*22cm*4.5cm
		Weight	1490g
		Cable	Customizable
		Connector	SMA or others
		Mounting Method	U bolt /Screw
Environmental		Operating Temperature	-40°C~+85°C
		Waterproof	IP67
		UV stabilized	YES
		Vibration	10 to 55Hz with 1.5mm amplitude 2hours
		Environmentally Friendly	ROHS Compliant

Maswell 5G/4G/LTE+GNSS Panel MIMO Combo Antenna

AN_Master_001-4

Product Configuration in Details



- ◆GNSS antenna supports GPS, Beidou, GLONASS and Gaileo 4 satellites L1 bands!
- ◆Support all 5g, 4G, 3G, GSM and dual band WiFi bands in the world!
- ◆Single antenna meets all wireless protocol needs, no need to buy other antenna!
- ◆Up to 6dBi gain for various signal transmitting and receiving scenarios!

Maswell 5G/4G/LTE+GNSS Panel MIMO Combo Antenna

AN_Master_001-4

Measured results:

S11

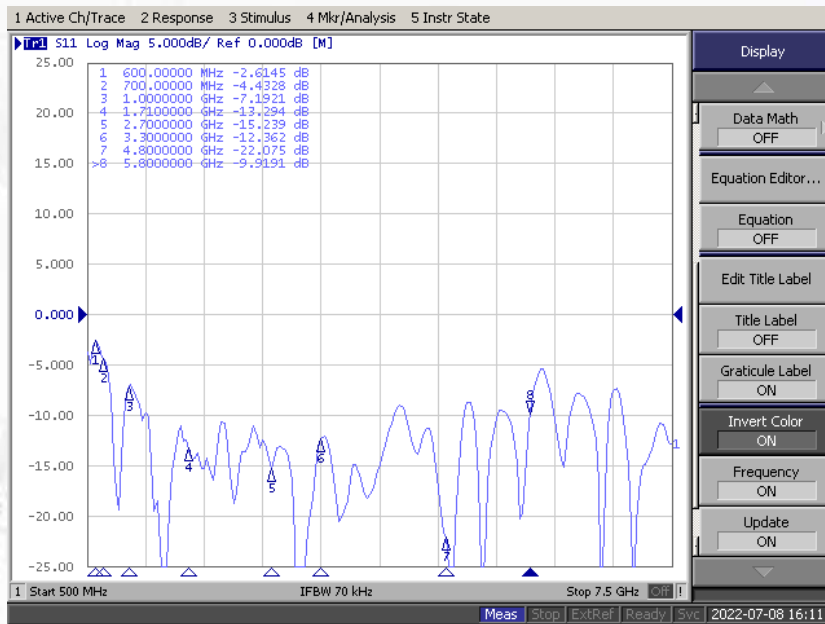

Antenna 1 (Main)

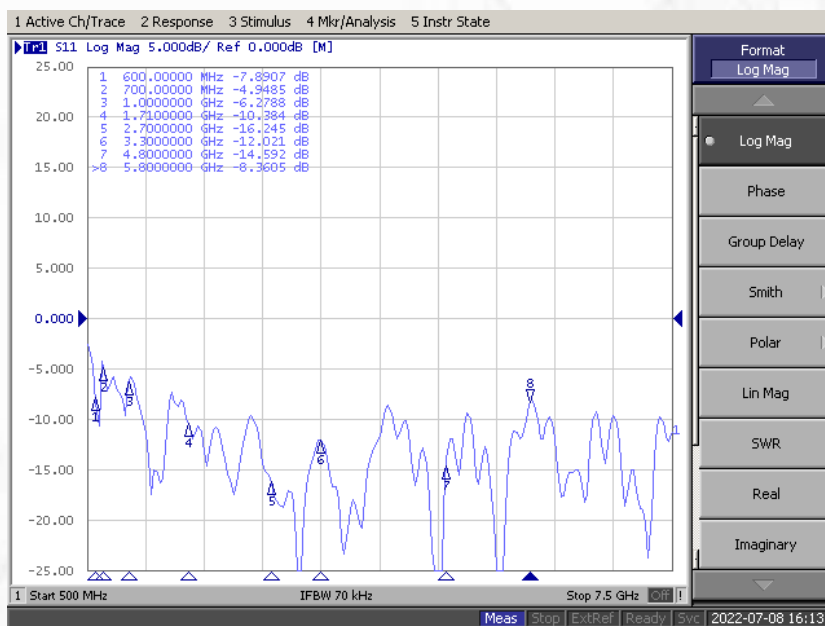

Antenna 2 (AUX)

Maswell 5G/4G/LTE+GNSS Panel MIMO Combo Antenna

AN_Master_001-4

Measured results:

VSWR

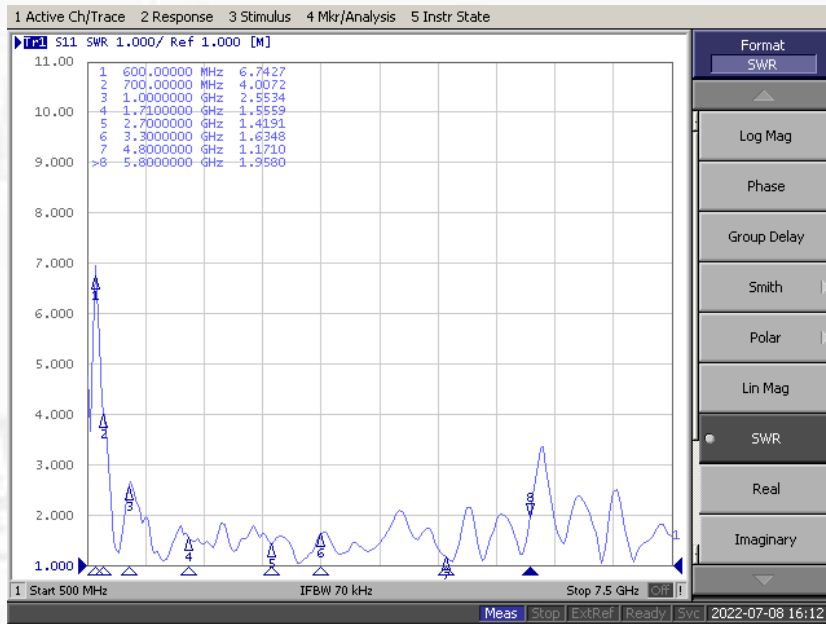

Antenna 1 (Main)

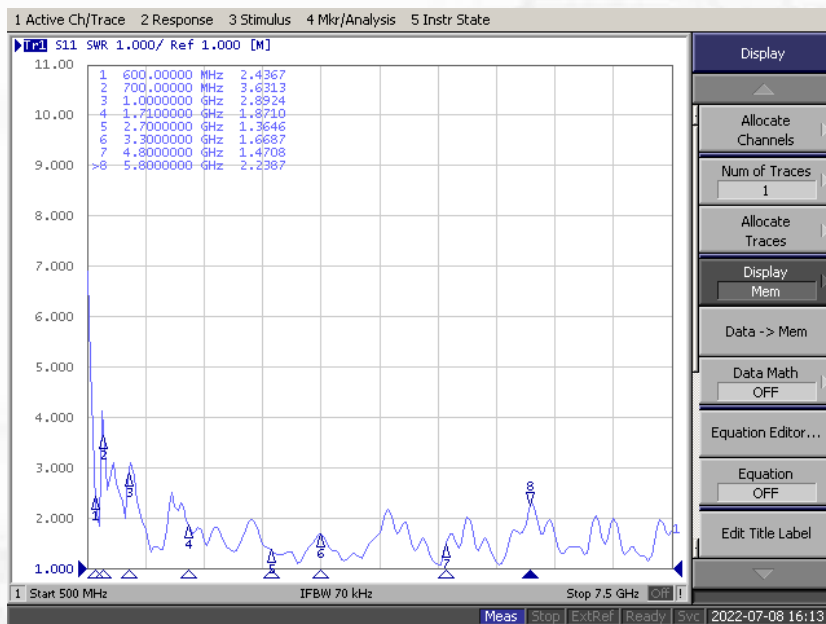

Antenna 2 (AUX)

Maswell 5G/4G/LTE+GNSS Panel MIMO Combo Antenna

AN_Master_001-4

Measured results:

Isolation

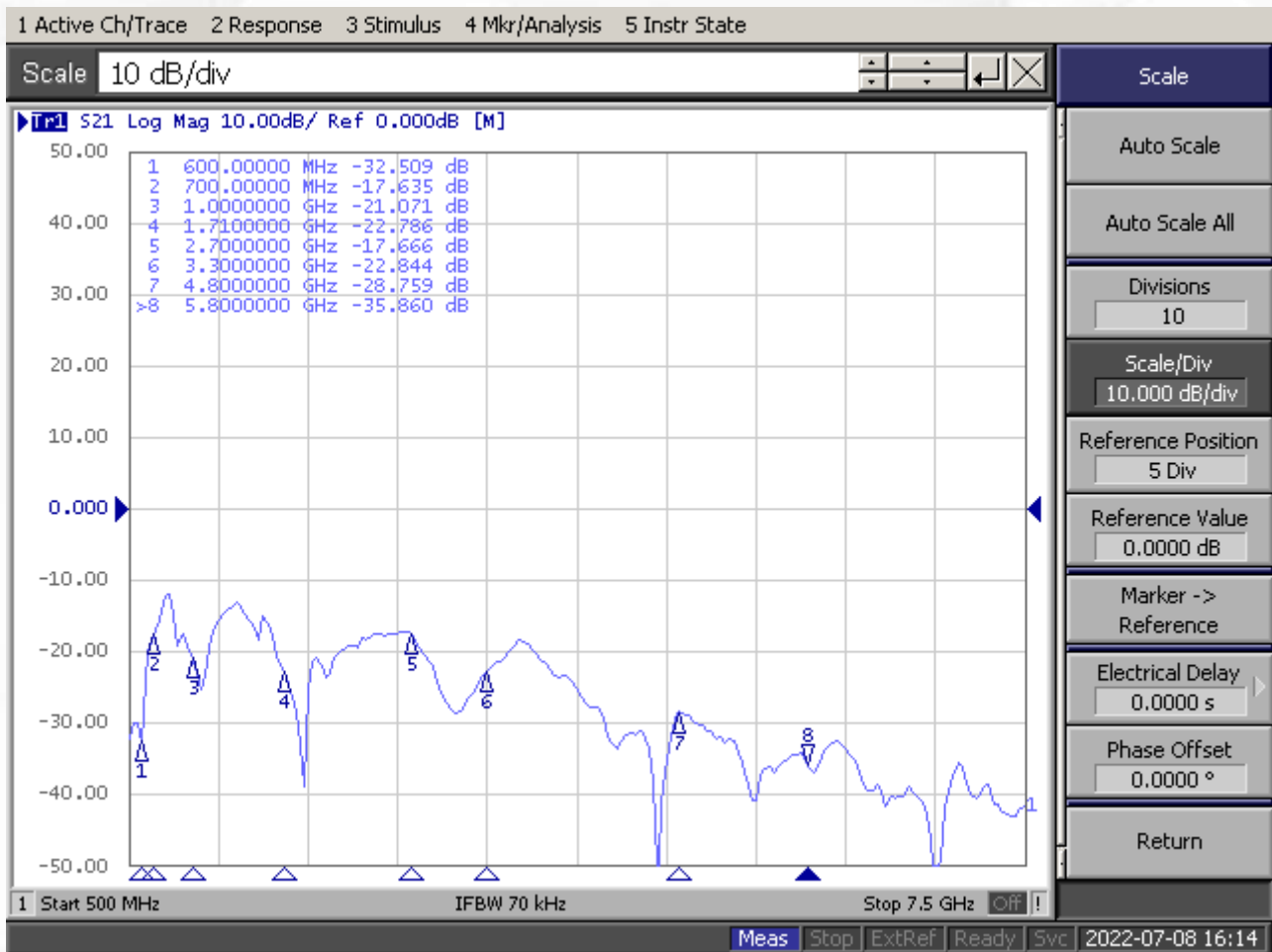

Maswell 5G/4G/LTE+GNSS Panel MIMO Combo Antenna

AN_Master_001-4

Radiation pattern: low frequency

Antenna 1

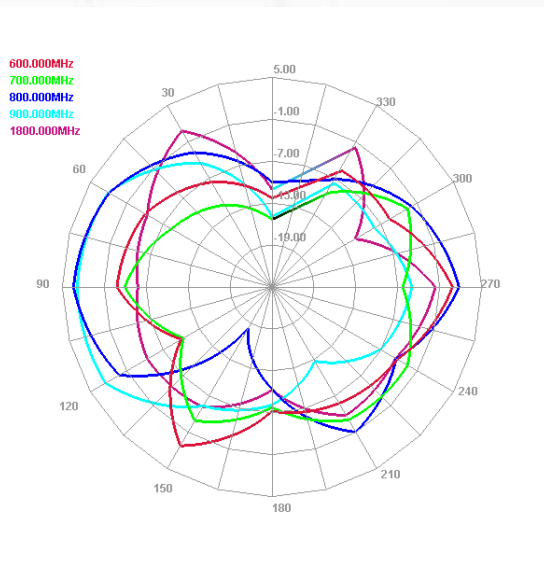

E plane

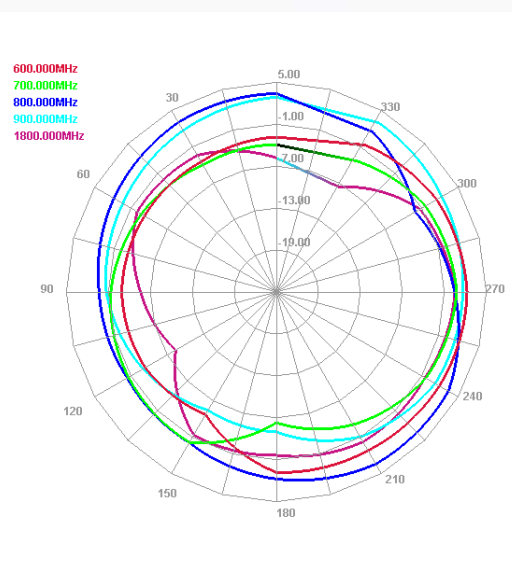

H plane

Antenna 2

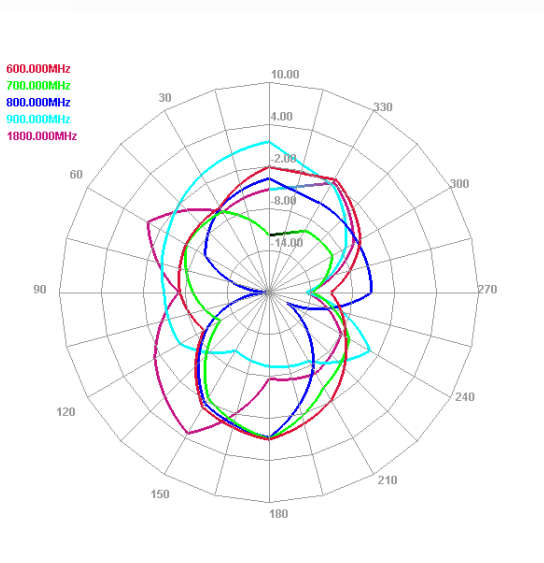

E plane

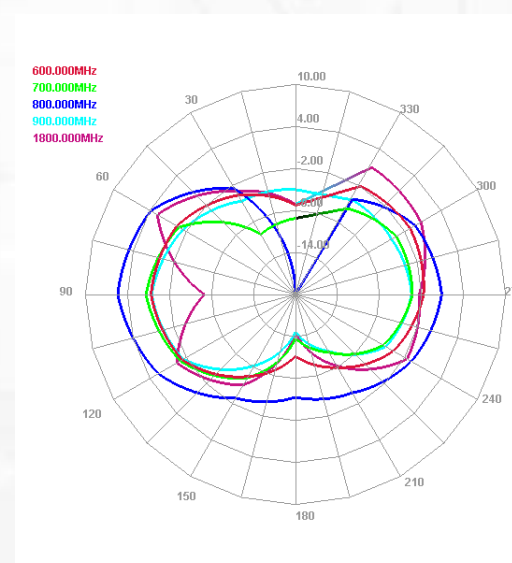

H plane

Maswell 5G/4G/LTE+GNSS Panel MIMO Combo Antenna

AN_Master_001-2

Radiation pattern: medium frequency

Antenna 1

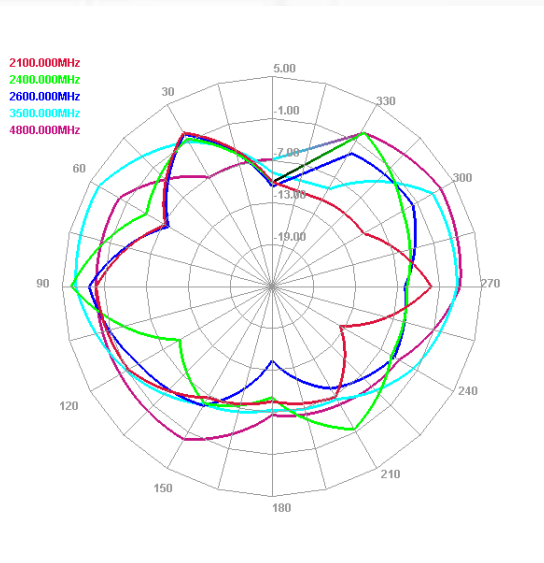

E plane

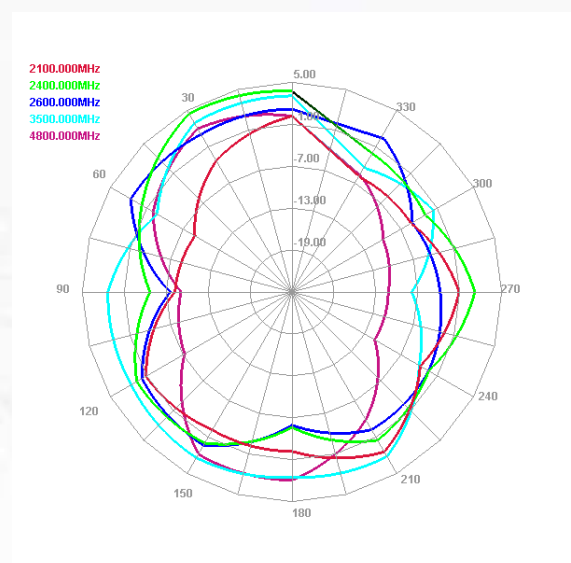

H plane

Antenna 2

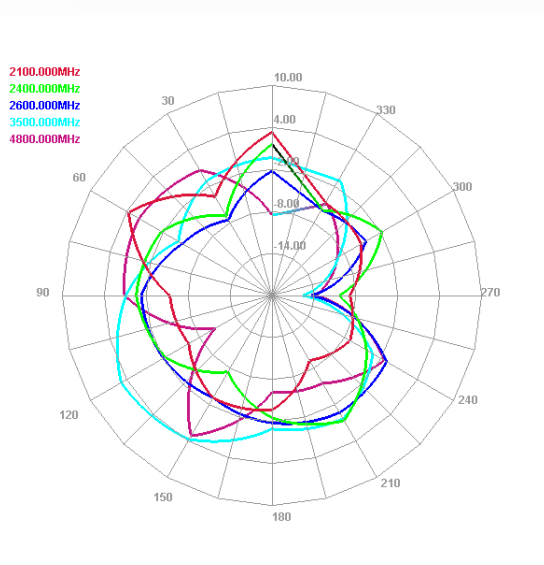

E plane

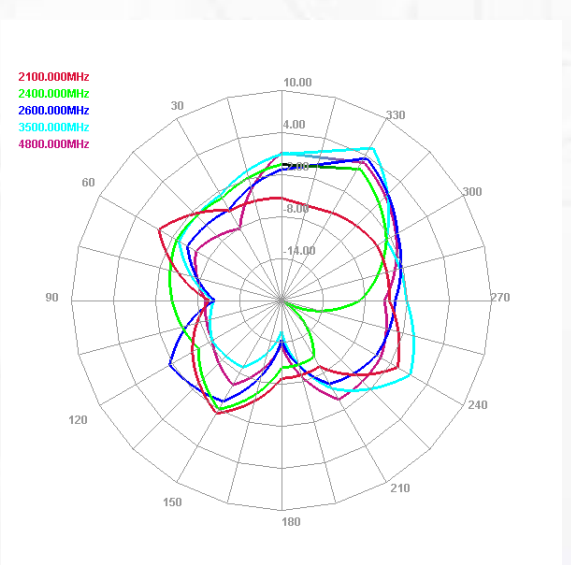

H plane

Maswell 5G/4G/LTE+GNSS Panel MIMO Combo Antenna

AN_Master_001-4

Radiation pattern: high frequency

Antenna 1

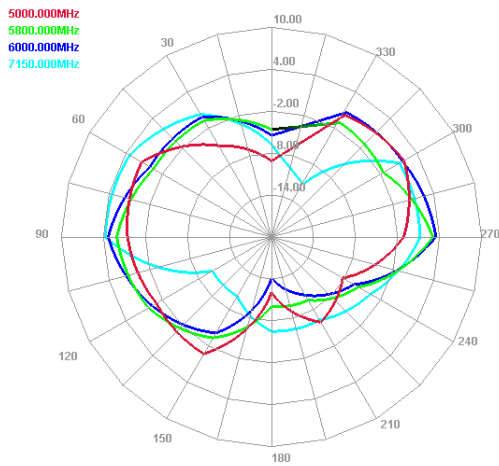

E plane

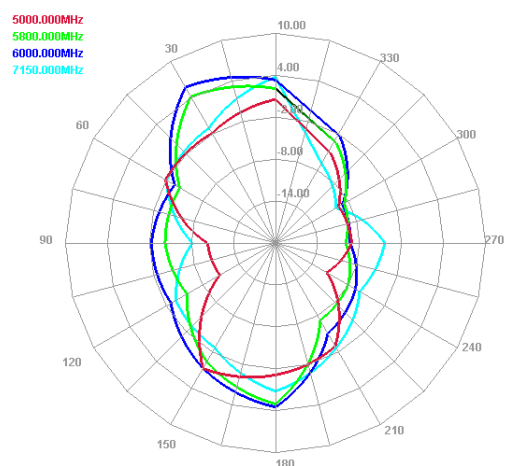

H plane

Antenna 2

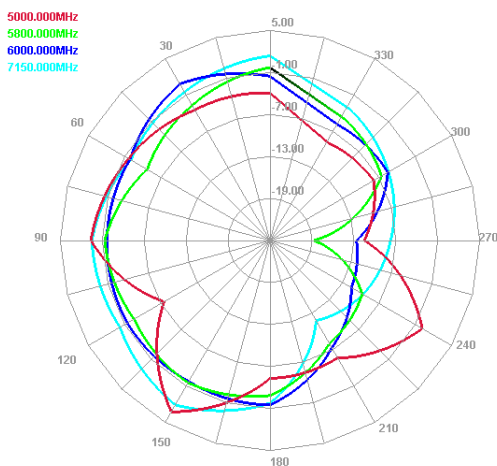

E plane

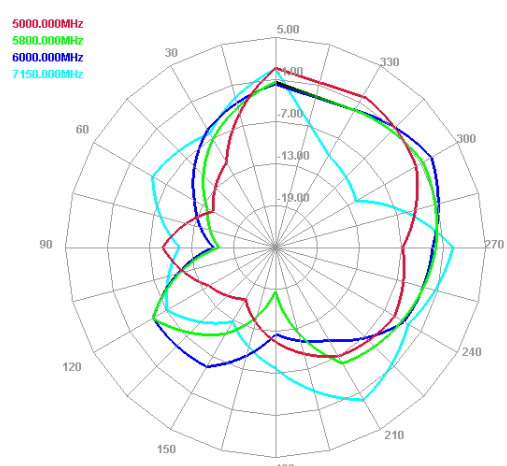

H plane

Maswell 5G/4G/LTE+GNSS Panel MIMO Combo Antenna

AN_Master_001-4

Measured Gain Performances (Antenna 1)

Freq (MHz)	Effi (%)	Gain (dBi)
600	49.54	2.25
650	50.1	0.8
700	51.47	1.35
750	60.18	2.34
800	82.03	3.43
850	79.01	4.01
900	72.49	3.32
950	66.85	3.61
1000	81.02	4.93
1050	85.14	5.45
1100	84.27	5.4
1150	92.99	5.74
1200	95.46	5.66
1250	100.65	6.93
1300	102.41	6.81
1350	91.17	5.79
1400	89.87	5.69
1450	104.09	6.18
1500	86.43	3.81
1550	84.55	4.42
1600	85.16	3.56
1650	81.36	3.31
1700	77.23	3.77
1750	79.44	4.55
1800	75.3	4.57
1850	73.69	3.98
1900	78.16	3.89
1950	75.08	3.71
2000	73.63	3.8
2050	73.16	4.25
2100	73.43	4.39
2150	60.17	3.86
2200	65.77	4.16
2250	75.59	4.03
2300	77.7	5
2350	82.09	5.28
2400	81.84	4.54

Freq (MHz)	Effi (%)	Gain (dBi)
2450	70.47	3.61
2500	69.82	3.35
2550	65.57	2.92
2600	65.75	3.57
2650	65.14	3.53
2700	65.84	3.81
2750	64.06	4.35
2800	85.73	5.64
2850	92.29	6.11
2900	92.25	6.45
2950	90.27	6.37
3000	90.46	5.81
3050	91.58	5.65
3100	95.75	5.22
3150	92.07	4.8
3200	98.23	4.33
3250	99.58	4.54
3300	98.7	4.49
3350	102.45	4.65
3400	103.74	4.41
3450	101.54	4.57
3500	95.24	4.54
3550	89.64	3.72
3600	91.01	3.99
3650	89.07	3.92
3700	79.67	3.82
3750	78.62	4.44
3800	76.35	3.92
3850	72.34	3.93
3900	74.33	4.79
3950	74.49	4.67
4000	74.22	4.35
4050	73.18	3.78
4100	69.43	4.07
4150	66.04	4.43
4200	65.91	4.62
4250	62.72	4.49

Maswell 5G/4G/LTE+GNSS Panel MIMO Combo Antenna

AN_Master_001-4

Measured Gain Performances (Antenna 1)

Freq (MHz)	Effi (%)	Gain (dBi)
4300	62.41	4.78
4350	63.11	4.7
4400	59.93	4.29
4450	60.25	4.4
4500	64.17	4.6
4550	61.73	4.51
4600	60.54	4.4
4650	65.3	4.28
4700	65.02	3.8
4750	62.39	3.45
4800	65.41	3.53
4850	60.62	3.07
4900	59.17	2.91
4950	54.59	2.77
5000	52.88	3
5050	49.38	2.77
5100	49.82	3.01
5150	47.96	3
5200	46.45	2.75
5250	48.24	2.73
5300	46.9	2.57
5350	51.49	2.75
5400	52.92	2.72
5450	52.15	2.35
5500	53.68	2.24
5550	54.67	2.18
5600	56.31	2.91
5650	57.85	3.54
5700	56.73	3.74
5750	56.66	4.21
5800	51.22	4.18
5850	51.9	4.24
5900	47.12	4.24
5950	61.48	5.51
6000	60.53	5.74
6050	65.05	5.93
6100	57.56	5.64

Freq (MHz)	Effi (%)	Gain (dBi)
6150	53.76	5.53
6200	51.41	5.19
6250	47.68	4.89
6300	47.86	4.69
6350	53.57	4.97
6400	54.29	4.67
6450	53.59	4.24
6500	59.93	4.3
6550	63.02	4.09
6600	61.93	4.2
6650	59.87	4.55
6700	58.86	5.08
6750	54.61	4.98
6800	52.16	5.13
6850	53.05	5.47
6900	50.18	5.58
6950	47.52	5.48
7000	48.07	5.63
7050	55.5	5.87
7100	56.8	5.71
7150	58.23	5.71
7200	59.98	5.56
7250	59.2	5.42
7300	58.49	5.49
7350	53.98	5.28
7400	51.96	5.1
7450	44.9	4.32
7500	44.93	4.15
7550	48.61	4.49
7600	50.21	3.68
7650	45.58	3.38
7700	47.25	3.61
7750	49	3.6
7800	52.29	3.77
7850	51.46	3.28
7900	63.93	3.92
7950	73.56	4.64
8000	70.04	4.88

Maswell 5G/4G/LTE+GNSS Panel MIMO Combo Antenna

AN_Master_001-4

Measured Gain Performances (Antenna 2)

Freq (MHz)	Effi (%)	Gain (dBi)
600	55.67	0.99
650	62.8	1.82
700	39.5	2.1
750	57.14	2.54
800	70.78	5.38
850	57.67	2.63
900	51.13	1.53
950	71.15	2.41
1000	70.4	3.13
1050	64.55	4.14
1100	74.5	5.78
1150	89.91	6.27
1200	99.54	6.33
1250	94.43	6.33
1300	92.32	6.11
1350	88.66	5.53
1400	88.54	4.74
1450	86.23	4.67
1500	66.32	3.77
1550	63.79	3.92
1600	66.1	4.15
1650	60.77	3.87
1700	58.63	4.31
1750	65.18	3.61
1800	64.58	3.26
1850	62.47	2.39
1900	67.7	2.72
1950	65.75	3.44
2000	57.66	2.88
2050	61.78	3.93
2100	70.16	4.97
2150	54.42	3.31
2200	59.29	3.34
2250	66.4	3.49
2300	70.84	3.87
2350	77.37	4.67
2400	76.14	4.77

Freq (MHz)	Effi (%)	Gain (dBi)
2450	66.57	4.4
2500	68.9	4.32
2550	69.49	4.39
2600	75.92	4.6
2650	74.07	4
2700	69.81	3.6
2750	69.28	4.51
2800	94.17	5.8
2850	92.58	5.44
2900	87.19	5.55
2950	86.4	5.5
3000	87.31	5.81
3050	85.45	5.89
3100	85.92	5.55
3150	84.29	5.28
3200	87.86	6.02
3250	90.66	6.48
3300	91.79	6.6
3350	91.63	6.71
3400	95.4	7.21
3450	94.66	7.56
3500	92.2	7.26
3550	89.08	7.05
3600	88.13	6.64
3650	85.7	6.41
3700	81.91	5.77
3750	78.08	5.17
3800	72.6	4.97
3850	69.89	4.71
3900	74.99	5.11
3950	74.68	4.92
4000	68.4	4.71
4050	64.69	4.79
4100	65.26	4.55
4150	69.62	4.66
4200	70.37	4.65
4250	67.07	4.42

Maswell 5G/4G/LTE+GNSS Panel MIMO Combo Antenna

AN_Master_001-4

Measured Gain Performances (Antenna 2)

Freq (MHz)	Effi (%)	Gain (dBi)
4300	67.33	4.17
4350	64.74	3.76
4400	61.97	3.64
4450	58.92	3.67
4500	61.96	4.12
4550	65.12	4.42
4600	63.99	4.4
4650	65.22	4.34
4700	64.36	3.99
4750	61.14	3.38
4800	61.96	3.74
4850	59.15	3.66
4900	58.73	4
4950	51.24	3.77
5000	47.29	3.57
5050	45.41	3.77
5100	51.9	4.61
5150	55.25	5.01
5200	51.63	4.75
5250	50.9	4.67
5300	50.08	4.57
5350	55.25	4.96
5400	53.75	4.95
5450	51.35	4.72
5500	49.78	4.64
5550	47.17	4.48
5600	48.72	4.74
5650	51.44	5.17
5700	47.96	4.79
5750	44.66	4.65
5800	40.88	4.2
5850	45.35	4.46
5900	43.37	3.96
5950	52.69	4.55
6000	51.21	4.83
6050	58.81	5.78
6100	56.23	5.69

Freq (MHz)	Effi (%)	Gain (dBi)
6150	49.65	5.23
6200	42.8	3.94
6250	37.84	2.7
6300	36.93	1.96
6350	39.51	2.27
6400	39.46	2.5
6450	39.01	1.87
6500	40.56	2.35
6550	39.49	2.19
6600	38.98	1.9
6650	35.28	1.3
6700	33.11	1.2
6750	31.18	1.23
6800	32.05	2.04
6850	34.35	2.72
6900	32.55	2.94
6950	30.17	2.43
7000	32.85	2.5
7050	38.94	3.07
7100	41.17	3.75
7150	40.83	3.88
7200	42.03	4.31
7250	39.7	4.37
7300	40.57	4.34
7350	43.78	4.7
7400	45.46	4.73
7450	42.2	4.09
7500	43.49	4.37
7550	51.26	5.1
7600	52.89	5.21
7650	46.62	4.43
7700	49.93	5.05
7750	57.97	5.65
7800	66.48	6.04
7850	60.87	5.24
7900	61.7	5.21
7950	66.31	5.44
8000	69.35	5.2

Maswell 5G/4G/LTE+GNSS Panel MIMO Combo Antenna

AN_Master_001-4

Package

AN_Master_001-4

Package with one cartoon:

Cable dimension: 27cm*27cm*9cm

Antenna weight: 1490g

Unit:cm

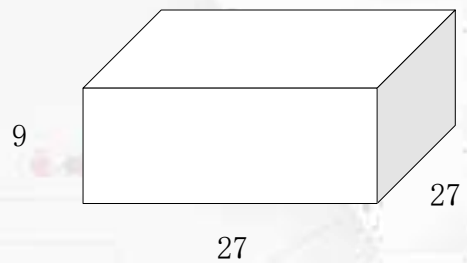

Installation Guide

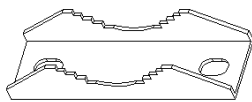

2PCS

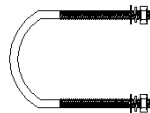

2PCS

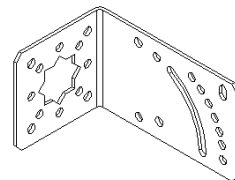

1PCS

