

Cree® Screen Master® 5-mm Oval LED C566T-RFS/AFS



PRODUCT DESCRIPTION

The oval LED is specifically designed for variable-message signs and passenger-information signs. The oval-shaped radiation pattern and high luminous intensity ensure that these devices are excellent for wide-field-of-view outdoor applications where a wide viewing angle and readability in sunlight are essential.

These lamps are tinted and diffused. The encapsulation resin contains anti-UV material in order to reduce the effects of long-term exposure to direct sunlight.

FEATURES

- Size (mm): 5
- Color and Typical Dominant Wavelength:
Red (628nm)
Amber (591nm)
- Luminous Intensity (mcd)
C566T-RFS:
(550 - 1520)
C566T-AFS:
(550 - 1520)
- Viewing angle:
70 X 40 degree
- Lead - Free
- RoHS Compliant

APPLICATIONS

- Electronic Signs & Signals (ESS)
- Full Color video screen
- Motorway Signs
- Variable Message Sign (VMS)
- Advertising signs
- Petrol Signs

ABSOLUTE MAXIMUM RATINGS ($T_A = 25^\circ\text{C}$)

Items	Symbol	Absolute Maximum Rating	Unit
		Red/Amber	
Forward Current	I_F	50 ^{Note1}	mA
Peak Forward Current ^{Note2}	I_{FP}	200	mA
Reverse Voltage	V_R	5	V
Power Dissipation	P_D	130	mW
Operation Temperature	T_{opr}	-40 ~ +95	$^\circ\text{C}$
Storage Temperature	T_{stg}	-40 ~ +100	$^\circ\text{C}$
Lead Soldering Temperature	T_{sol}	Max. 260 $^\circ\text{C}$ for 3 sec. max. (3 mm from the base of the epoxy bulb)	

Note:

1. For long term performance the drive currents between 10mA and 30mA are recommended. Please contact CREE sales representative for more information on recommended drive conditions.
2. Pulse width ≤ 0.1 msec, duty $\leq 1/10$.

TYPICAL ELECTRICAL & OPTICAL CHARACTERISTICS ($T_A = 25^\circ\text{C}$)

Characteristics	Color	Symbol	Condition	Unit	Minimum	Typical	Maximum
Forward Voltage	Red/Amber	V_F	$I_F = 20$ mA	V		2.3	2.6
Reverse Current	Red/Amber	I_R	$V_R = 5$ V	μA			100
Dominant Wavelength	Red	λ_D	$I_F = 20$ mA	nm	620	628	635
	Amber	λ_D	$I_F = 20$ mA	nm	584	591	596
Luminous Intensity	Red	I_V	$I_F = 20$ mA	mcd	550	850	
	Amber	I_V	$I_F = 20$ mA	mcd	550	900	

INTENSITY BIN LIMIT ($I_f = 20 \text{ mA}$)

Red

Bin Code	Min.(mcd)	Max.(mcd)
R0	550	770
S0	770	1100
T0	1100	1520

Amber

Bin Code	Min.(mcd)	Max.(mcd)
R0	550	770
S0	770	1100
T0	1100	1520

- Tolerance of measurement of luminous intensity is $\pm 15\%$

COLOR BIN LIMIT ($I_f = 20 \text{ mA}$)

Red

Bin Code	Min.(nm)	Max.(nm)
RC	620	535

Amber

Bin Code	Min. (nm)	Max. (nm)
A2	584	587
A3	587	590
A4	590	593
A5	593	596

- Tolerance of measurement of dominant wavelength is $\pm 1 \text{ nm}$

ORDER CODE TABLE*

Color	Kit Number	Luminous Intensity (mcd)		Dominant Wavelength				Pack- age
		Min.	Max.	Color Bin	Min. (nm)	Color Bin	Max. (nm)	
Red	C566T-RFS-CR0T0CC1	550	1520	RC	620	RC	635	Bulk
Red	C566T-RFS-CR0T0CC2	550	1520	RC	620	RC	635	Ammo

Color	Kit Number	Luminous Intensity (mcd)		Dominant Wavelength				Pack- age
		Min.	Max.	Color Bin	Min. (nm)	Color Bin	Max. (nm)	
Amber	C566T-AFS-CR0T0251	550	1520	A2	584	A5	596	Bulk
Amber	C566T-AFS-CR0T0252	550	1520	A2	584	A5	596	Ammo

Notes:

1. The above kit numbers represent order codes that include multiple intensity-bin and color-bin codes. Only one intensity-bin code and one color-bin code will be shipped on each bulk. Single intensity-bin code and single color-bin codes will not be orderable.
2. Please refer to the "Cree LED Lamp Reliability Test Standards" document for reliability test conditions.
3. Please refer to the "Cree LED Lamp Soldering & Handling" document for information about how to use this LED product safely.

GRAPHS

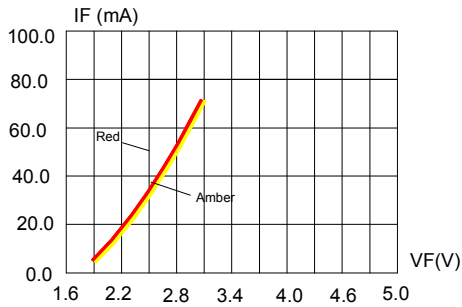

FIG.1 FORWARD CURRENT VS. FORWARD VOLTAGE.

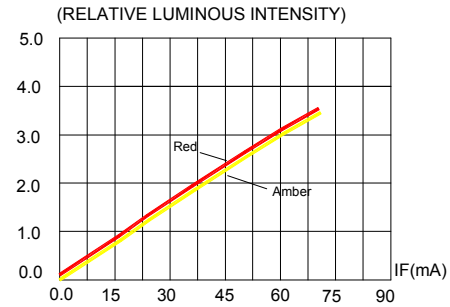

FIG.2 RELATIVE LUMINOUS INTENSITY VS. FORWARD CURRENT

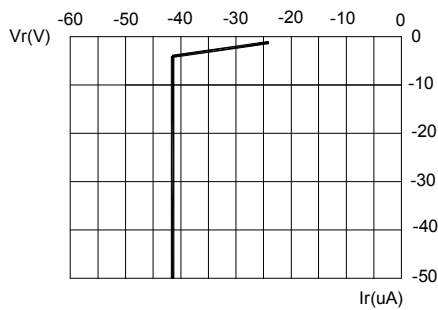

FIG.3 RED & AMBER REVERSE CURRENT VS. REVERSE VOLTAGE.

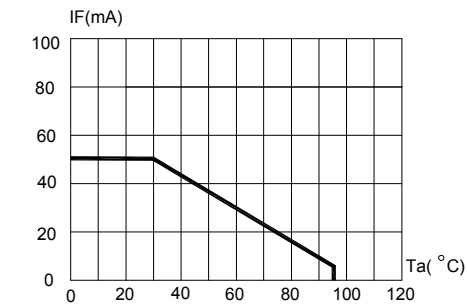

FIG.4 RED & AMBER MAXIMUM FORWARD DC CURRENT VS AMBIENT TEMPERATURE ($T_{jmax}=105^{\circ}C$)

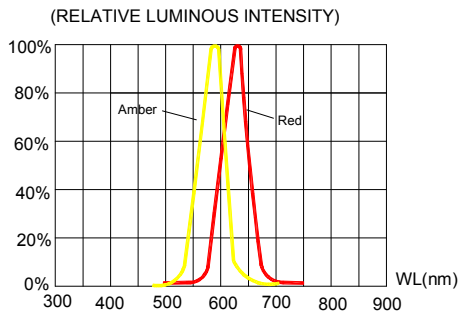

FIG.5 RELATIVE LUMINOUS INTENSITY VS. WAVELENGTH.

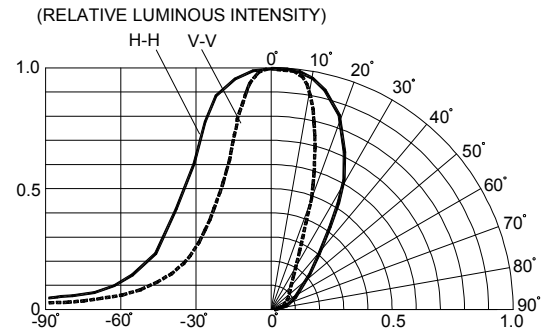

FIG.6 FAR FIELD PATTERN

The above data are collected from statistical figures that do not necessarily correspond to the actual parameters of each single LED. Hence, these data will be changed without further notice.

MECHANICAL DIMENSIONS

All dimensions are in mm. Tolerance is ± 0.25 mm unless otherwise noted.

An epoxy meniscus may extend about 1.5 mm down the leads.

Burr around bottom of epoxy may be 0.5 mm max.

C566T-RFS:

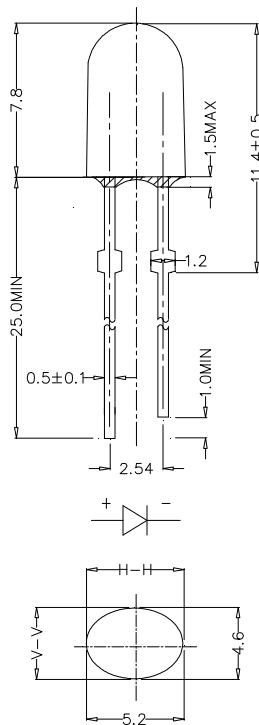

C566T-AFS:

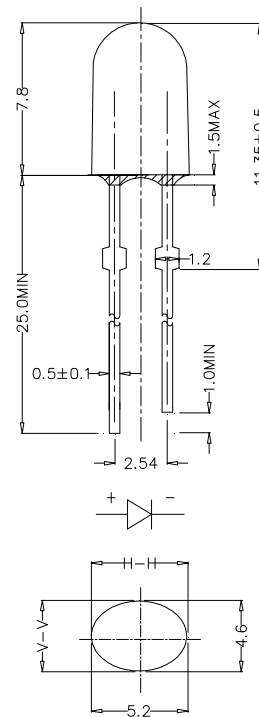

NOTES

RoHS Compliance

The levels of environmentally sensitive, persistent biologically toxic (PBT), persistent organic pollutants (POP), or otherwise restricted materials in this product are below the maximum concentration values (also referred to as the threshold limits) permitted for such substances, or are used in an exempted application, in accordance with EU Directive 2002/95/EC on the restriction of the use of certain hazardous substances in electrical and electronic equipment (RoHS), as amended through April 21, 2006.

Vision Advisory Claim

Users should be cautioned not to stare at the light of this LED product. The bright light can damage the eye.

KIT NUMBER SYSTEM

All dimensions in mm. Cree LED lamps are tested and sorted into performance bins. A bin is specified by ranges of color, forward voltage, and brightness. Sorted LEDs are packaged for shipping in various convenient options. Please refer to the "Cree LED Lamp Packaging Standard" document for more information about shipping and packaging options.

Cree LEDs are sold by order codes in combinations of bins called kits. Order codes are configured in the following manner:

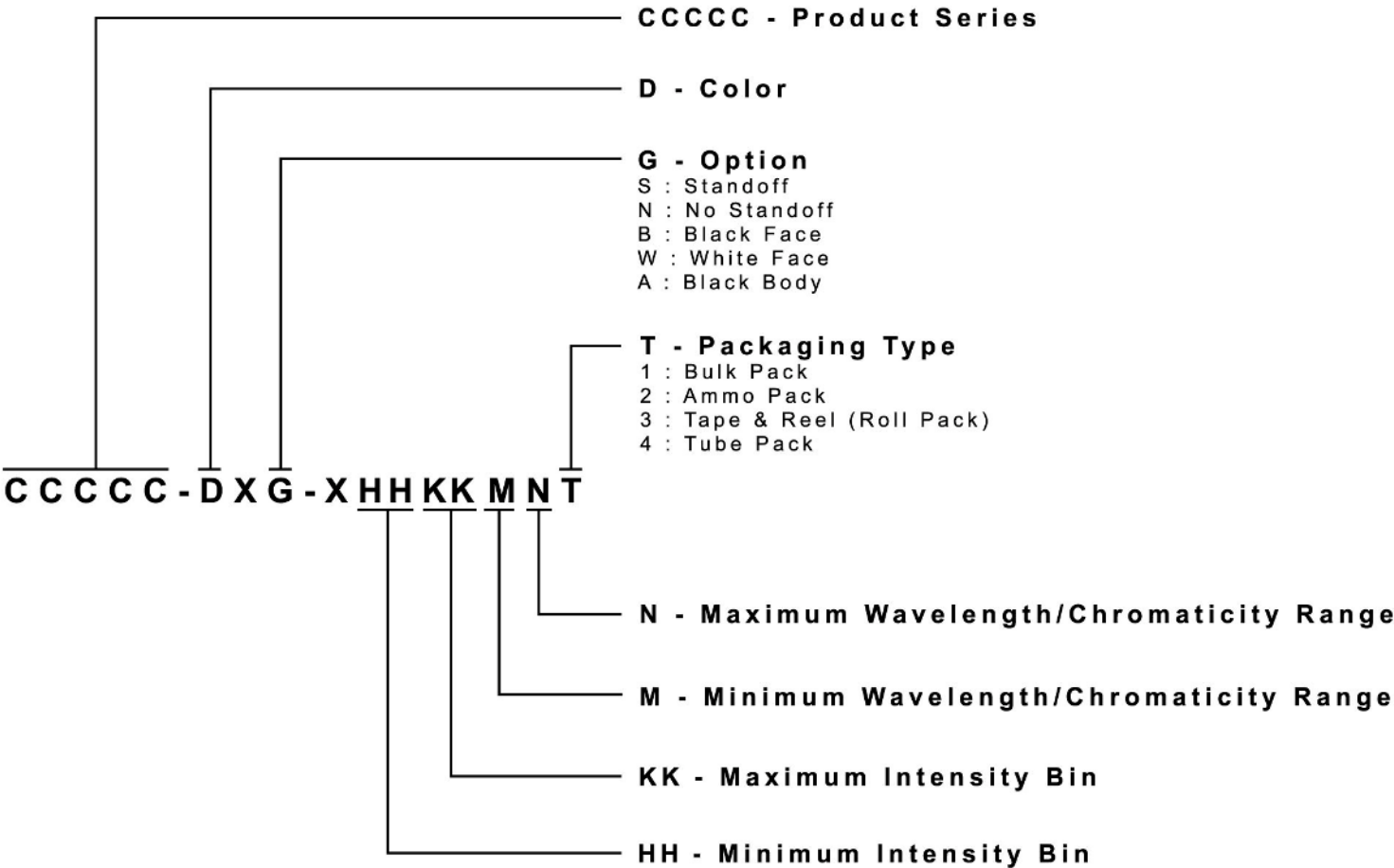

PACKAGING

Features:

- The LEDs are packed in cardboard boxes after packaging in normal or anti-electrostatic bags.
- Cardboard boxes will be used to protect the LEDs from mechanical shock during transportation.
- The boxes are not water resistant, and they must be kept away from water and moisture.
- The Bulk Pack types of packaging.
- Max 500 pcs per bulk and Max 2500 pcs per ammo.

Bulk Pack Packaging Type:

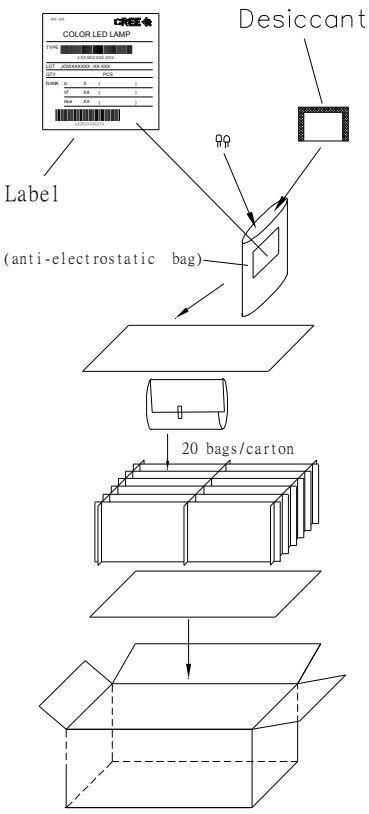

Ammo Pack Packaging Type:

