

REVISIONS					
REV	ECO	DESCRIPTION	DATE	BY	APPR
A1	-	NEW RELEASE	13DEC19	ZENIN	TOMMY

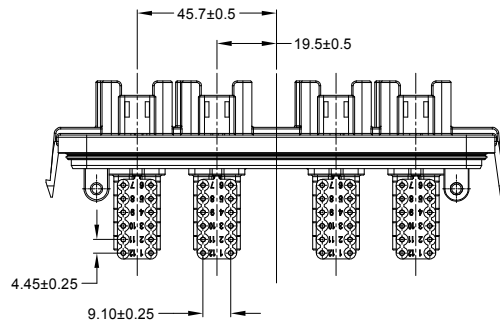
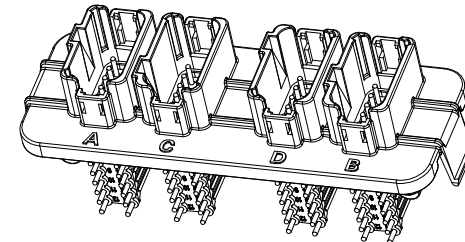
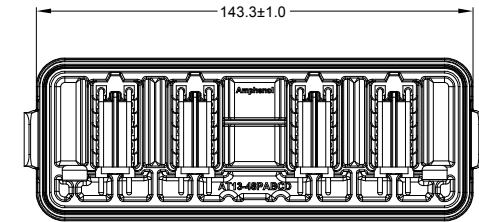
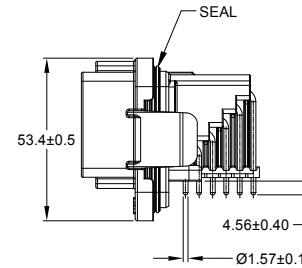
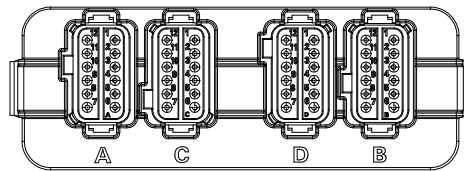
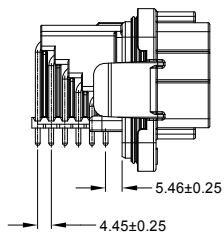
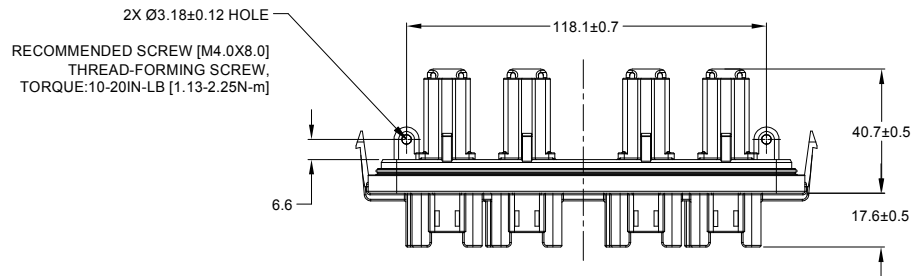

NOTES: UNLESS OTHERWISE SPECIFIED

- MATERIAL:
  - HOUSING: THERMOPLASTIC, BLACK
  - SEAL: SILICONE RUBBER
  - CONTACT: COPPER ALLOY
- MODIFICATIONS: RA PCB MOUNT
- SPECIFICATIONS:
  - 3.1 CURRENT RATING: 13 AMPS
  - 3.2 OPERATING TEMPERATURE: -55°C TO +125°C
  - 3.3 DIELECTRIC WITHSTANDING VOLTAGE: LESS THAN 2 MILLIAMPS CURRENT LEAKAGE @ 1500 VOLTS AC
  - 3.4 INSULATION RESISTANCE: 1000 MEGOHMS MIN @ 25°C
  - 3.5 MOISTURE RESISTANCE: IP67 ( MATED CONDITION )
  - 3.6 MATING CYCLE DURABILITY: 100 CYCLES
  - 3.7 RoHS COMPLIANT
- MATING PART: AT06-12SX-\*  
(X = A,B,C,D KEYS ; \* = ALL MODIFICATIONS)
- THIS RECEPTACLE IS USED WITH AIPXE-5X650A-xxxx AND AIPXE-5X650B-xxxx ENCLOSURE (xxxx= ALL MODIFICATIONS)
- SEE SHEET 2&3 FOR OTHER KEY ARRANGEMENTS
- ALL DIMENSIONS ARE FOR REFERENCE USE ONLY

SEE SHEET 2&3		DESCRIPTION		ITEM
QUANTITY	PART NUMBER	MATERIALS LIST		
<p>UNLESS OTHERWISE SPECIFIED</p> <p>1) All dimensions are in metric(mm).</p> <p>2) Tolerances are as follows:</p> <p>1 PL DEC ±0.30 Fractions ±1/64</p> <p>2 PL DEC ±0.15 Angles ±1°</p> <p>3 PL DEC ±0.08</p> <p>3) Note reference = </p>				
SIGNATURES		DATE		
DRAWN: ZENIN DENG		13DEC19		
CHECKED: ORION LI		13DEC19		
ENGINEER:		APPROVAL: TOMMY XIE 13DEC19		
APPROVAL:		CUSTOMER:		
MATERIAL SPECIFICATIONS:		THIS DRAWING IS SUPPLIED FOR INFORMATION ONLY. DESIGN FEATURES, SPECIFICATIONS AND PERFORMANCE DATA SHOWN HEREON ARE THE PROPERTY OF THE AMPHENOL CORPORATION. NO RIGHTS OF REPRODUCTION ARE IMPLIED. ALL DIMENSIONS ARE SUBJECT TO NORMAL MANUFACTURING VARIATIONS.		
PROCESS SPECIFICATIONS:		NEXT ASSY:		
SIZE		TYPE	DWG NO.	REVISION
B C-			AT13-XPX-XXXX	A1
SCALE		NONE		
SHEET 1 OF 3				

TITLE: ARMOR IPX RECEPTACLE AT HEADER, 4X 12POS, 16# SIZE PIN  
 DWG NO: AT13-XPX-XXXX  
 REV: A1  
 SH: 1  
 OF: 3

REVISIONS					
REV	ECO	DESCRIPTION	DATE	BY	APPR
A1	-	NEW RELEASE	13DEC19	ZENIN	TOMMY

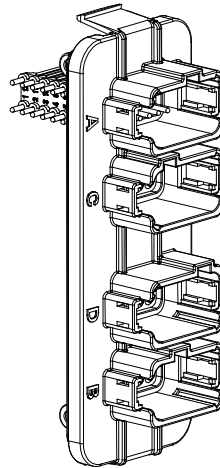
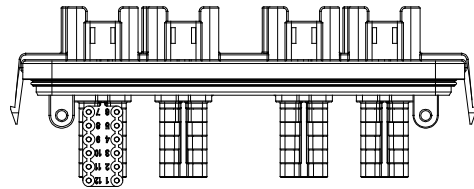
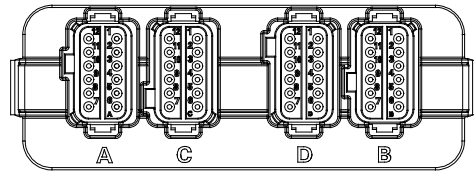

KEY A

AT13-12PA-XXXX VARIANTS		
CONTACT PLATING	PART NUMBER	REFERENCE
GOLD	AT13-12PA-GR02	DT13-12PA-GR02
TIN	AT13-12PA-R015	DT13-12PA-R015

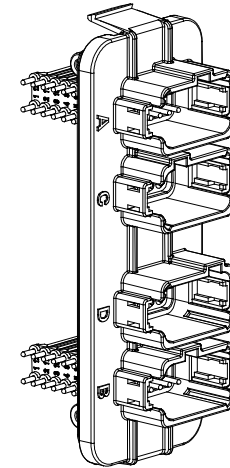
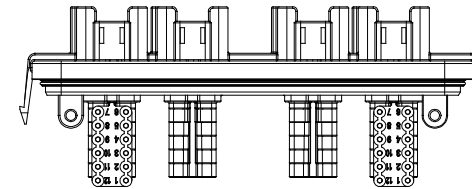
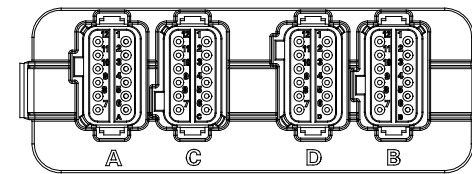

KEY A B

AT13-24PAB-XXXX VARIANTS		
CONTACT PLATING	PART NUMBER	REFERENCE
GOLD	AT13-24PAB-BM01	DT13-24PAB-GR02
TIN	AT13-24PAB-BM03	DT13-24PAB-R015

AT13-XPX-XXXX		DESCRIPTION		ITEM
QUANTITY	PART NUMBER	MATERIALS LIST		
<p><b>UNLESS OTHERWISE SPECIFIED</b></p> <p>1) All dimensions are in metric(mm).</p> <p>2) Tolerances are as follows:</p> <p>1 PL DEC ±0.30      Fractions ±1/64</p> <p>2 PL DEC ±0.15      Angles ±1°</p> <p>3 PL DEC ±0.08</p> <p>3) Note reference = </p>				
<p><b>SIGNATURES</b>      <b>DATE</b></p> <p>DRAWN: ZENIN DENG      13DEC19</p> <p>CHECKED: ORION LI      13DEC19</p> <p>ENGINEER:</p> <p>APPROVAL: TOMMY XIE      13DEC19</p> <p>CUSTOMER:</p>		<p><b>Amphenol</b></p> <p>Sine Systems - www.amphenol-sine.com 44724 Morley Drive Clinton Township, MI 48036</p>		
<p>MATERIAL SPECIFICATIONS:</p> <p>PROCESS SPECIFICATIONS:</p> <p>NEXT ASSY:</p>		<p>THIS DRAWING IS SUPPLIED FOR INFORMATION ONLY. DESIGN FEATURES, SPECIFICATIONS AND PERFORMANCE DATA SHOWN HEREON ARE THE PROPERTY OF THE AMPHENOL CORPORATION. NO RIGHTS OF REPRODUCTION ARE IMPLIED. ALL DIMENSIONS ARE SUBJECT TO NORMAL MANUFACTURING VARIATIONS.</p>		
		<p>SIZE TYPE      DWG NO.      REVISION</p> <p>B C-      AT13-XPX-XXXX      A1</p>	<p>SCALE      SHEET 2 OF 3</p>	

TITLE: ARMOR IPX RECEPTACLE AT HEADER, 4 X 12POS, 16# SIZE PIN  
 DWG NO.: AT13-XPX-XXXX  
 REV: A1  
 SH: 2  
 OF: 3

REVISIONS					
REV	ECO	DESCRIPTION	DATE	BY	APPR
A1	-	NEW RELEASE	13DEC19	ZENIN	TOMMY

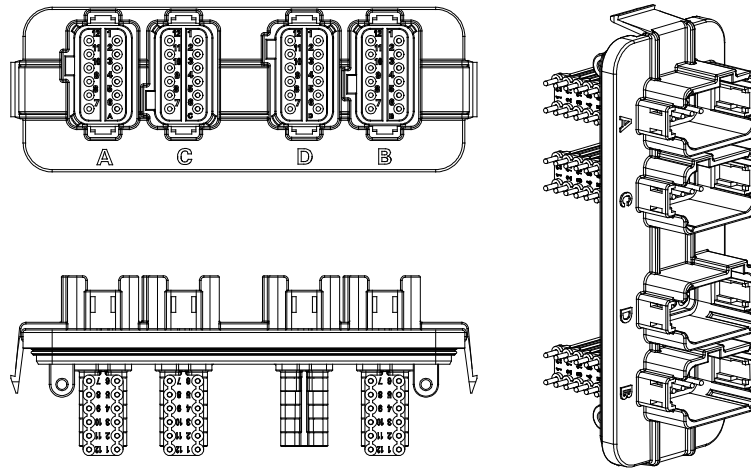

KEY A B C

AT13-36PABC-XXXX VARIANTS		
CONTACT PLATING	PART NUMBER	REFERENCE
GOLD	AT13-36PABC-BM01	DT13-36PAB-GR02
TIN	AT13-36PABC-BM03	DT13-36PAB-R015

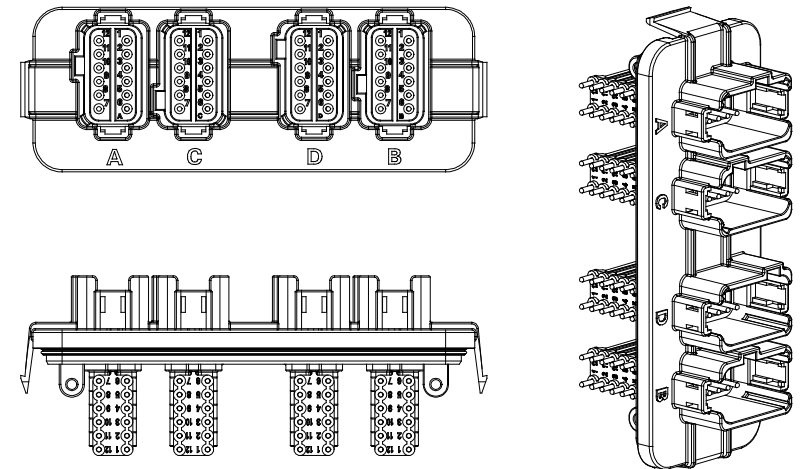

KEY A B C D

AT13-48PABCD-XXXX VARIANTS		
CONTACT PLATING	PART NUMBER	REFERENCE
GOLD	AT13-48PABCD-BM01	DT13-48PABCD-GR02
TIN	AT13-48PABCD-BM03	DT13-48PABCD-R015

AT13-XPX-XXXX		DESCRIPTION		ITEM
QUANTITY	PART NUMBER	MATERIALS LIST		
<p><b>UNLESS OTHERWISE SPECIFIED</b></p> <p>1) All dimensions are in metric(mm).</p> <p>2) Tolerances are as follows:</p> <p>1 PL DEC ±0.30      Fractions ±1/64</p> <p>2 PL DEC ±0.15      Angles ±1°</p> <p>3 PL DEC ±0.08</p> <p>3) Note reference = </p>				
<p><b>SIGNATURES</b></p> <p>DRAWN: ZENIN DENG      DATE: 13DEC19</p> <p>CHECKED: ORION LI      DATE: 13DEC19</p> <p>ENGINEER:</p> <p>APPROVAL: TOMMY XIE      DATE: 13DEC19</p>		<p><b>Amphenol</b></p> <p>Sine Systems - www.amphenol-sine.com 44724 Morley Drive Clinton Township, MI 48036</p>		
<p>MATERIAL SPECIFICATIONS:</p> <p>PROCESS SPECIFICATIONS:</p> <p>NEXT ASSY:</p>		<p>THIS DRAWING IS SUPPLIED FOR INFORMATION ONLY. DESIGN FEATURES, SPECIFICATIONS AND PERFORMANCE DATA SHOWN HEREON ARE THE PROPERTY OF THE AMPHENOL CORPORATION. NO RIGHTS OF REPRODUCTION ARE IMPLIED. ALL DIMENSIONS ARE SUBJECT TO NORMAL MANUFACTURING VARIATIONS.</p>		
		<p>SIZE: B C-</p> <p>SCALE: NONE</p>	<p>DWG NO: AT13-XPX-XXXX</p>	<p>REVISION: A1</p> <p>SHEET 3 OF 3</p>

TITLE: ARMOR IPX RECEPTACLE AT HEADER, 4 X 12POS, 16# SIZE PIN  
 DWG NO: AT13-XPX-XXXX  
 REV: A1  
 SH: 3  
 OF: 3