

Messrs: Digi-Key

Specification

※In the case of specification change, KKC Part Number also will change.



Customer part number	-
Customer specification Number	-
Product	Quartz Crystal
Model	CX3225GB
Frequency	per KB101-11315-432 3/12
KKC Part Number	per KB101-11315-432 3/12

【RoHS compliant, MSL 1】

[STAMP]

Sales office
 KYOCERA Corporation
 (Electronic Components Sales Division)
 Head Office 6 Takeda Tobadono-cho, Fushimi-ku,
 Kyoto 612-8501 Japan
 TEL 075-604-3500
 FAX 075-604-3501



Production
 KYOCERA KINSEKI Corporation
 (Crystal Unit Sales Promotion Division)
 1-8-1, Izumi-honcho, Komae-Shi,
 Tokyo 201-8648 Japan
 TEL 03-5497-3111
 FAX 03-5497-3209

Design KYOCERA KINSEKI Yamagata Co. Crystal Units Overseas Design Section Crystal Units Division 1	Issued by 	Approved by 
--	--	---

※Recycled paper is being used for the conservation of nature.

Date: 2011/12/ 9

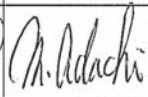
Change History

Rev	DESCRIPTION	DATE	DRAWN	CHECKED	APPROVED
0	Spec release	2011/ 8/ 4	S.Suzuki	M.Adachi	N.Abe
△1	【PART NUMBER LIST】 Frequency addition.	2011/12/ 9			



[PART NUMBER LIST]

Nominal Frequency (MHz)	KKC Part number	ESR (Ω)	Nominal Frequency Code
10	CX3225GB10000D0HPQZ1	300	10000
12	CX3225GB12000D0HPQZ1	250	12000
13.56	CX3225GB13560D0HPQZ1	250	13560
14.31818	CX3225GB14318D0HPQZ1	100	14318
14.7456	CX3225GB14745D0HPQZ1	100	14745
16	CX3225GB16000D0HPQZ1	80	16000
18.432	CX3225GB18432D0HPQZ1	80	18432
19.2	CX3225GB19200D0HPQZ1	80	19200
20	CX3225GB20000D0HPQZ1	60	20000
22.5792	CX3225GB22579D0HPQZ1	60	22579
24	CX3225GB24000D0HPQZ1	60	24000
24.576	CX3225GB24576D0HPQZ1	60	24576
25	CX3225GB25000D0HPQZ1	60	25000
27	CX3225GB27000D0HPQZ1	50	27000
30	CX3225GB30000D0HPQZ1	50	30000
32	CX3225GB32000D0HPQZ1	50	32000
33.333	CX3225GB33333D0HPQZ1	50	33333
38.4	CX3225GB38400D0HPQZ1	50	38400
40	CX3225GB40000D0HPQZ1	50	40000
48	CX3225GB48000D0HPQZ1	50	48000
54	CX3225GB54000D0HPQZ1	50	54000

1. APPLICATION

This specification sheet is applied to quartz crystal "CX3225GB".

2. PART NUMBER

per KB101-11315-432 3/12

3. RATINGS

Items	SYMB.	Rating	Unit	Remarks
Operating Temperature	Topr	-40~+85	°C	
Storage Temperature range	Tstg	-40~+85	°C	

4. CHARACTERISTICS**4-1 ELECTRICAL CHARACTERISTICS**

Items	Electrical Specification					Test Condition	Remarks
	SYMB.	Min	Typ.	Max	Unit		
Mode of Vibration		Fundamental					
Nominal Frequency	F0		※		MHz		
Nominal Temperature	T _{NOM}		25		°C		
Load Capacitance	CL		8.0		pF		
Frequency Tolerance	df/F	-20.0		+20.0	PPM	+25±3°C Network Analyzer E5100A 200 μA	
Frequency Temperature characteristics	df/F	-30.0		+30.0		-40~+85°C	+25±3°C
Frequency Aging Rate		-5.0		+5.0		1 year	+25±3°C
Equivalent Series Resistance	ESR			※	Ohms	Network Analyzer E5100A 200 μA	
Drive Level	Pd	0.01		100	μW		
Insulation Resistance	IR	500			M ohms	100V(DC)	

※ per KB101-11315-432 3/12

5. APPEARANCES, PHYSICAL DIMENSION

OUTLINE DIMENSION (not to scale)

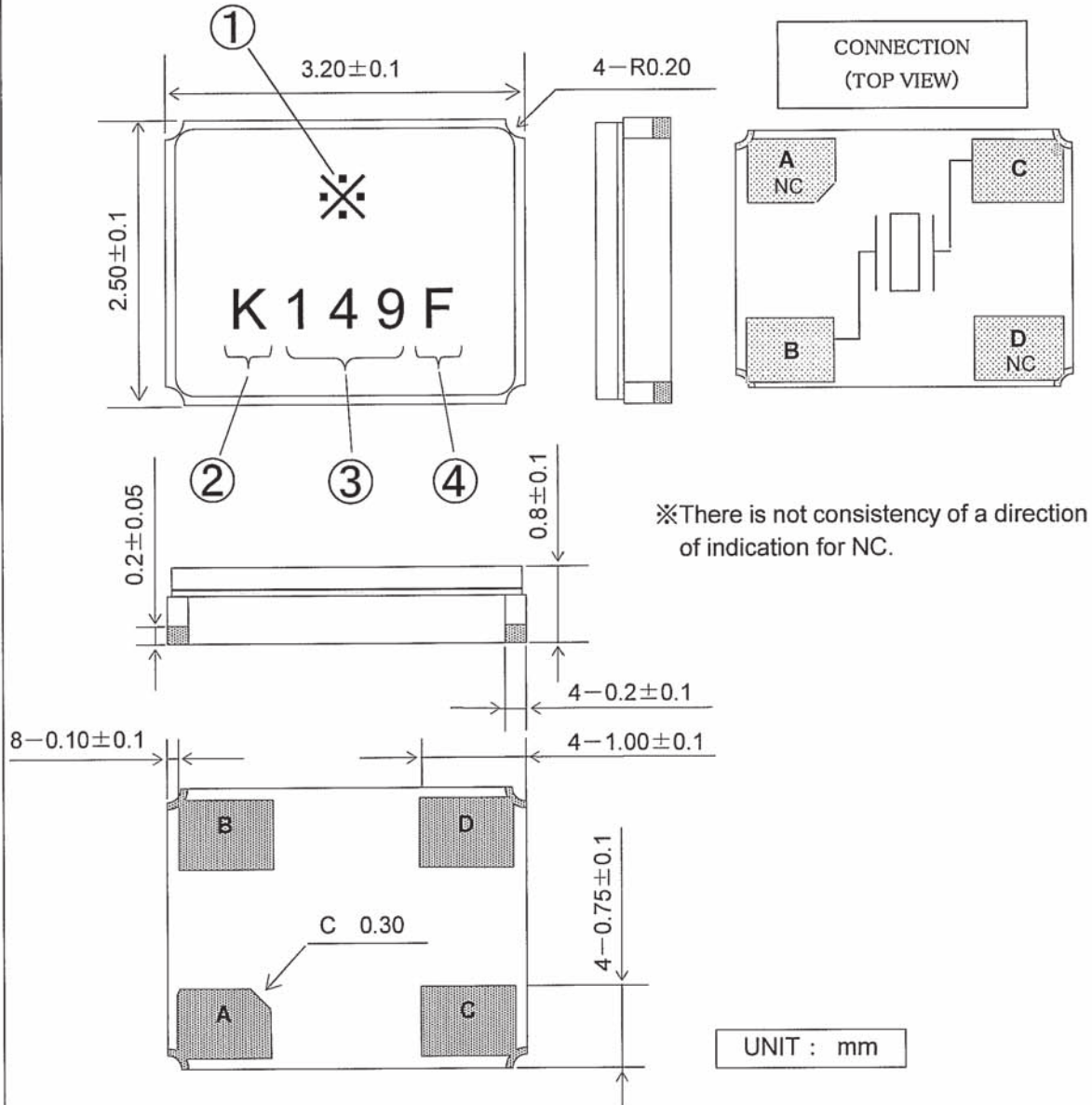

MARKING

① Nominal Frequency

Move the number of maximum indication beams of the frequency to five digits, and omit less than kHz.

※ per KB101-11315-431 3/12

② Identification

③ Date Code

Year···LAST 1 DIGIT of YEAR AND WEEK

※ For details to LOT CALENDAR

(Ex)DEC. 9, 2011 → 149

④ Manufacturing Location

F···KYOCERA KINSEKI Philippines, Inc.

※The font of marking is reference.

6. RECOMMENDED LAND PATTERN (not to scale)

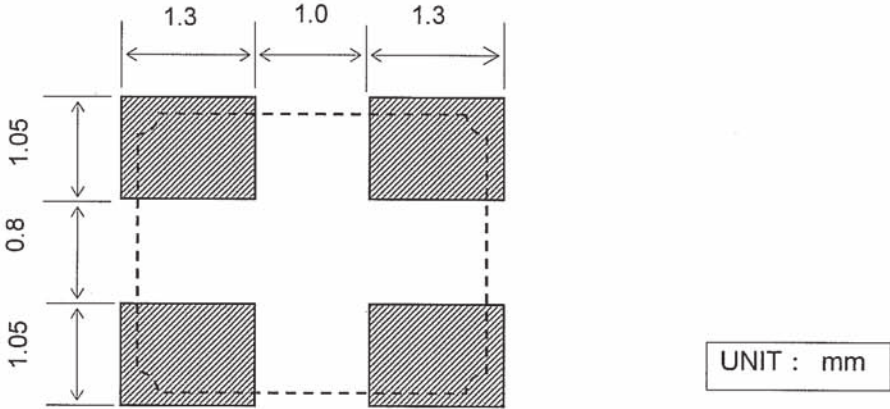

7. Quality Assurance

Location

KYOCERA KINSEKI Philippines, Inc. : KYOCERA KINSEKI Philippines, Inc. Quality Assurance Division

Quality guarantee

When the failure by the responsibility of our company occurs clearly after delivery within 1 year, a substitute article etc. is appropriated gratuitously and this is guaranteed. However, when passing 1 year after delivery, there is a case where I am allowed to consider as onerous repair after both consultation.

8.TAPING & REEL 梱包補助材

8-1.Dimensions (寸法図)

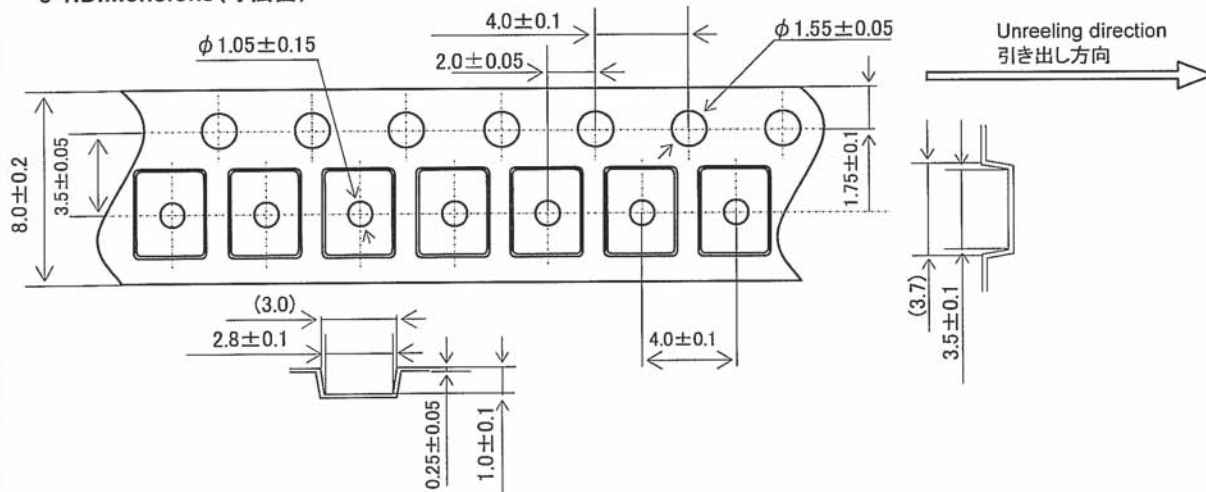

8-2.Leader and trailer tape (リーダー部テープ部及び終末端部テープ)

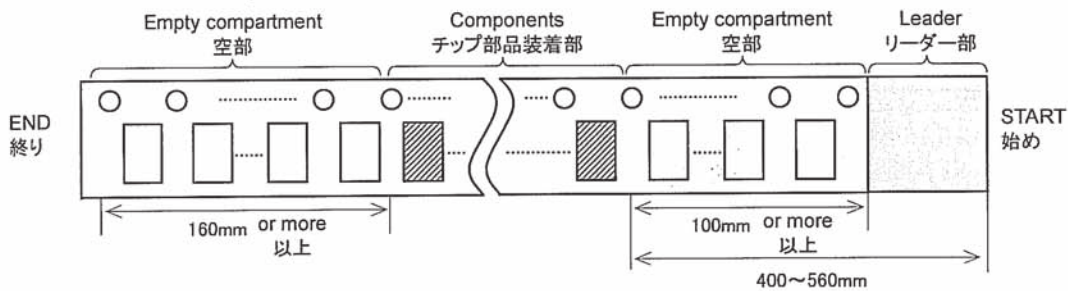

8-3.Direction (The direction shall be seen from the top cover tape side)

テーピング方向(トップカバーテープ側から見る。)

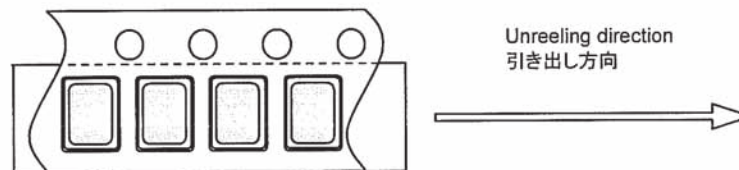

8-4.Specification (記事)

1. Material of the carrier tape shall be PS (ESD). {装着テープの材質は、PS とする。(静電対策品)}
2. Material of the seal tape shall be polyester(ESD). {シールテープの材質はポリエステルとする。(静電対策品)}
3. The seal tape shall not cover the sprocket holes. And not protrude from the carrier tape. {シールテープは送り穴をふさいだり、装着テープからはみ出していないこと。}
4. Tensile strength of the tape : 10N or more. {テープの引張り強度は 10N 以上}
5. The R of the corner without designation is 0.2RMAX. {指定無きコーナーの R は 0.2RMAX}
6. Disalignment between centers of the cavity and sprocket hole shall be 0.05mm or less. {角穴の中心と送り穴の中心とのずれは、0.05mm 以下とする。}
7. Cumulative pitch tolerance of "P₀" shall be ± 0.2 mm at 10 pitches. {"P₀"の累積ピッチ許容差は、10 ピッチで ± 0.2 mm とする。}
8. The number of lack is 0.1% of 1 reel total part number (the number of the table letters) or the part following whose 1 either is big. (But, the thing which lack of the continuance is not in.) {欠落数は、1 リールの総部品数(表示数)の 0.1%、又は、1 個のいずれか大きい方以下。(但し、連続の欠落のないこと。)}
9. The marking on parts is not fixed its direction, its electrical characteristic is equal. [エンボステープ内での製品表示向きが一定ではないが、電気的特性に影響は無し。]
10. Peeling force of the seal tape: 0.3 to 0.7N. {シールテープ剥離強度 0.3~0.7N}

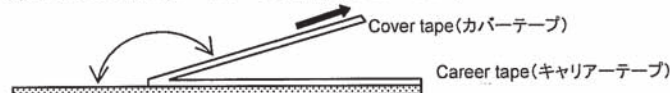

8-5.Reel specifications リール仕様

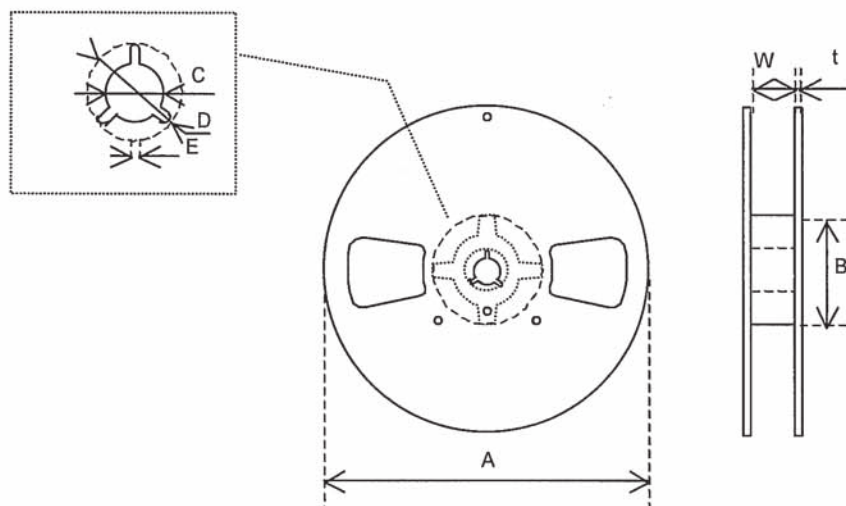

(Nonconductor type Reel)

In the case of $\Phi 180$ Reel(1000 or 3000 pcs)

	A	B	C	D
Dimension	$\phi 180 +0/-1.5$	$\phi 60 +1/-0$	$\phi 13 \pm 0.2$	$\phi 21 \pm 0.8$
Symbol	E	W	t	
Dimension	2.0 ± 0.5	9 ± 1	2.0 ± 0.5	

(Unit : mm)

9.Environmental requirements

After following test, frequency shall not change more than $\pm 10 \times 10^{-6}$

And CI, $\pm 20\%$ or 5Ω of large value.

- | | | |
|-----|-------------------------|--|
| 9.1 | Resistance to Shock | Test condition
Natural dropped from height 100cm onto hard wood board in 3 times |
| 9.2 | Resistance to Vibration | Test condition
frequency : 10—55 —10 Hz
Amplitude : 1.5mm
Cycle time : 15 minutes
Direction : X,Y,Z (3direction),2 h each. |
| 9.3 | Resistance to Heat | Test condition
The quartz crystal unit shall be stored at a temperature of $+85 \pm 2^\circ\text{C}$ for 500 h.
Then it shall be subjected to standard atmospheric conditions for 1 h ,after which measurement shall be made. |
| 9.4 | Resistance to Cold | Test condition
The quartz crystal unit shall be stored at a temperature of $-40 \pm 2^\circ\text{C}$ for 500 h.
Then it shall be subjected to standard atmospheric conditions for 1 h ,after which measurement shall be made. |
| 9.5 | Thermal Shock | Test condition
The quartz crystal unit shall be subjected to 500 successive change of temperature cycles , each as shown in table below, Then it shall be subjected to standard atmospheric conditions for 1h, after which measurements shall be made.
Cycle : $-40 \pm 2^\circ\text{C}$ (30min.) $\sim 25 \pm 2^\circ\text{C}$ (5min.)
$\sim +85 \pm 2^\circ\text{C}$ (30min.) $\sim 25 \pm 2^\circ\text{C}$ (5min.) |

9.6 Resistance to Moisture

Test condition

The quartz crystal unit shall be stored at a temperature of $60 \pm 2^\circ\text{C}$ with relative humidity of 90% to 95% for 240 h. Then it shall be subjected to standard atmospheric conditions for 1h, after which measurements shall be made

9.7 Soldering condition

1) Material of solder

Kind ... lead free solder paste

Melting point ... $220 \pm 5^\circ\text{C}$

2) Temp.profile of reflow soldering system

	Temp [$^\circ\text{C}$]	Time[sec]
Peak	260 ± 5	10 (max.)
Preheating	180 (typ.)	100 (typ.)
Total	—	200 (max.)

Temp. profile of reflow

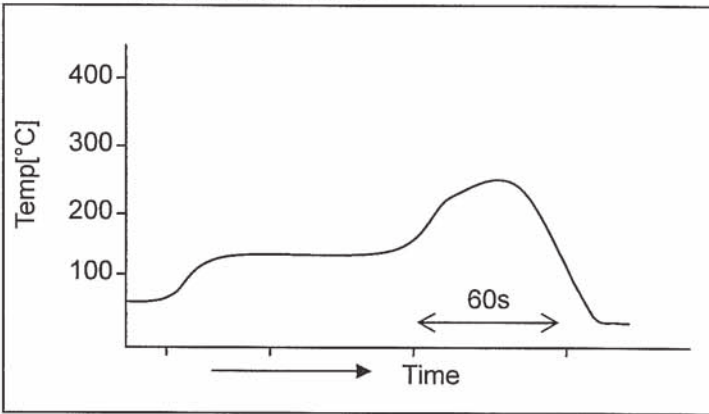

3) Hand Soldering Temperature: 350°C , Time: 3sec

9.8 Intensity for bending in circuit board

Solder this product in center of the circuit board of $40\text{mm} \times 100\text{mm}$, and add the deflection of 3mm as the bottom figure.

Test board : $t = 1.6\text{mm}$

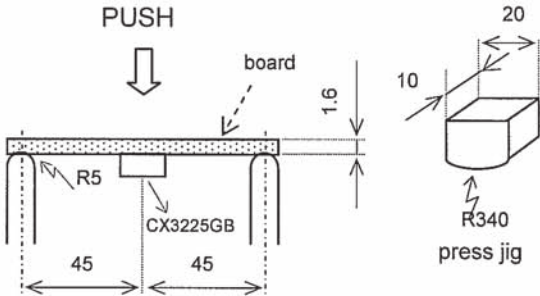

UNIT : mm

10.Cautions for use**(1) Automatic mounting machine use**

Please use after affirmation that select the mounting machine model with a shock small if possible in the case of use of an automatic mounting machine, and it does not have breakage. There is a risk of a quartz crystal unit breakage occurring and not functioning normally by too much shock etc..

(2) Conformity of a circuit

In case of use of an oscillation circuit, please insert in a quartz crystal unit in series resistance 5 time as many as the standard value of equivalent in-series resistance, and confirm oscillating. Please remove resistance which inserted after the notes above-mentioned examination in the quartz crystal unit in series, and use it.

(3) After making the Quartz Crystal mount on a printed circuit board ,if it is required to devide the printed circuit board into another one, use it with attentive confirmation so that a warp cased by this dividing might not affect any damage. When designing a printed circuit board as well as handling the mounting As much as possible. The quartz crystal shall be passed through the reflow furnace. Then it shall be subjected to standard atmospheric conditions, after which cleaning shall be made.**11.Storage conditions**

Storage at prolonged high temperature or low temperature and the storage by high humidity cause degradation of frequency accuracy, and degradation of soldering nature. Storage is performed at the temperature of 18-30 degrees C, and the humidity of 20-70 Percent in the state of packing, and a term is 6 months.

12.Others

When any questions and opinions are in the written matter of these delivery specifications, I will ask connection of you from the our company issue day within 45 days. In a connection no case, a written matter is consented to it and employed within a term.