

Silver Line Series – Single & Multi-Output Linears

The SolaHD Silver Line Series follows the industry accepted footprint for open frame, linear power supplies. Standard screw terminal connections and optional covers are offered for safety considerations.

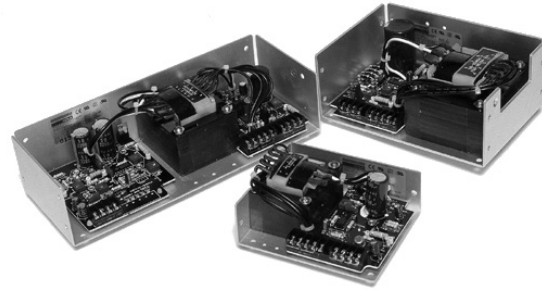

Applications

- Industrial Control Circuits and Components
- Instrumentation
- Drives
- CNC Machinery
- Equipment for food industry
- Microprocessor Circuits
- Analog Circuits
- Noise sensitive Circuitry and Sensors

Features

- Easy-to-install screw terminal connections
- Cover options
- Industry standard footprint
- Universal input and approvals (115/230 Vac)
- Low noise, extremely quiet DC output. For noise sensitive or analog circuitry.
- Fast transient response. Ideal for test applications.
- Built-in OVP on 5 V models and optional on 12, 15 and 24 V models
- Automatic resetting overload protection
- Short circuit protected
- Two year limited warranty

Certifications and Compliances

-  Recognized Component, ITE
- UL 60950-1/CSA C22.2 N0. 60950-1



Specifications

Parameter	Condition	Limit
Input		
Input Voltage	-	100/120/220/230/240 Vac Selectable
Input Frequency	-	47-63 Hz
Output		
Line Regulation	for 10% change	0.05%
Load Regulation	for 50% change	0.05%
Ripple	-	3.0 mV maximum Peak-to-Peak
DC Output Adjustment Range	-	±5% Minimum
Overvoltage Protection	-	All 5-Volt outputs include build-in OVP as standard (setting is 6.2 V ±0.4 V) OVP is optionally available on other types
Transient Response Time	at 50% Load Changes	50 msec.
Overload Protection	-	Automatic current limit foldback
Remote Sensing	Available to compensate for output voltage drop on selected models.	0.5 Vdc
General		
Operating Temperature Range	Derate to 40% at +70°C	0 to +50 °C
Storage Temperature Range	-	-25 °C to +85 °C
Temperature Coefficient (Typical)	-	0.01% 0 °C
Stability	After warm-up	±.5%
EMI/RFI	Linear power supplies have inherently low conducted and radiate noise levels	For most system applications they will meet requirements of FCC Class B and VDE 0871 for Class B
Cover Option	Derate power by an additional 15%	
Cooling	Forced air. 20 CFM required for full rating Derate 30% without cooling	

Specifications are typical. Load Regulation on outputs without Remote Sense, .1% typical.

SL Series Selection Table

Catalog Number	Output 1	Output 2	Output 3	Case
SLS-05-030-1T	5 V @ 3 A *2	-	-	A
SLS-05-060-1T	5 V @ 6 A *2	-	-	B1
SLS-05-090-1T	5 V @ 9 A *2	-	-	C
SLS-05-120-1T	5 V @ 12 A *2	-	-	I2
SLS-12-017T 1	12 V @ 1.7 A 2 or 15 V @ 1.5 A	-	-	A
SLS-12-034T	12 V @ 3.4 A 2	-	-	B1
SLS-12-051T	12 V @ 5.1 A 2	-	-	C
SLS-12-068T	12 V @ 6.8 A 2	-	-	I2
SLS-15-045T	15 V @ 4.5 A 2	-	-	C
SLS-15-060T	15 V @ 6 A 2	-	-	I2
SLS-24-012T	24 V @ 1.2 A v	-	-	A
SLS-24-024T	24 V @ 2.4 A 2	-	-	B2
SLS-24-036T	24 V @ 3.6 A 2	-	-	C
SLS-24-048T	24 V @ 4.8 A 2	-	-	I2
SLS-24-072T	24 V @ 7.2 A 2	-	-	K
SLS-24-120T	24 V @ 12.0 A 2	-	-	L
SLD-12-1010-12T 1	12 V @ 1 A or 15 V @ .8 A	-12 V @ 1 A or -15 V @ .8	-	H1
SLD-12-1818-12T 1	12 V @ 1.8 A or 15 V @ 1.5 A	-12 V @ 1.8 A or -15 V @ 1.5 A	-	D
SLD-12-3434-12T	12 V @ 3.4 A 2	-12 V @ 3.4 A 2	-	I3
SLD-15-3030-15T	15 V @ 3 A 2	-15 V @ 3 A 2	-	I3
SLD-12-6034-05T	5 V @ 6 A *2	12 V @ 3.4 A 2	-	I1
SLD-12-3015-05T	5 V @ 3 A *2	12 V @ 1.5 A	-	C1
SLT 12-20404-12T 1	5 V @ 2 A *2	12 V @ .4 A or 15 V @ .4 A	-12 V @ .4 A or -15 V @ .4 A	H2
SLT 12-31010-12T 1	5 V @ 3 A *2	12 V @ 1 A 2 or 15 V @ .8 A	-12 V @ 1 A 2 or -15 V @ .8 A	F
SLT 12-61818-12T 1	5 V @ 6 A *2	12 V @ 1.8 A or 15 V @ 1.5 A	-12 V @ 1.8 A or -15 V @ 1.5 A	G2
Over Voltage Protector (OVP)				
SLO-12-000-1	6.2 V to 34 V Adjustable @ 8 A	For Cases B through K		J1
SLO-12-000-TB	6.2 V to 34 V Adjustable @ 8 A	For Case A or Cases B through K (when used with a cover)		J2

Notes:

* With Built-In OVP

1. 12/15 Volt models are factory set for 12 Volt operation. 15 Volt operation is field adjustable.

2. With Remote Sense (R.S.)

Dimensions - inches (mm)

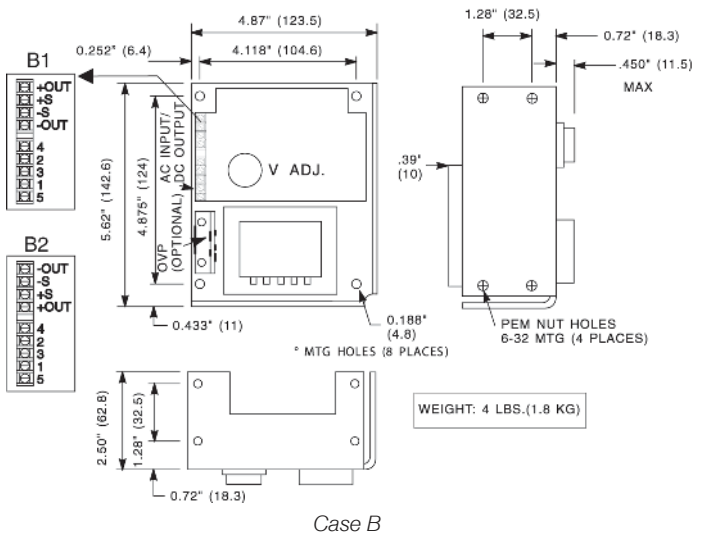
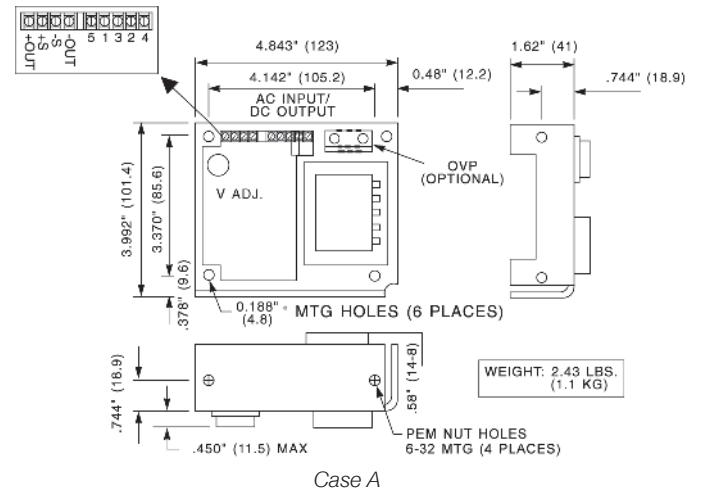

Cover Options

Catalog Number	Description	Catalog Number	Description
SLCASA-CVR	Cover for Case A	SLCASI-CVR	Cover for Cases I1, I2, & I3
SLCASB-CVR	Cover for Case B	SLCASK-CVR	Cover for Case K
SLCASC-CVR	Cover for Case C	SLCASL-CVR	Cover for Case L

Note:

Covers are sold separately. When used, derate the power supply by 15% of its rated value.

Silver Line Dimensions (inches/mm)

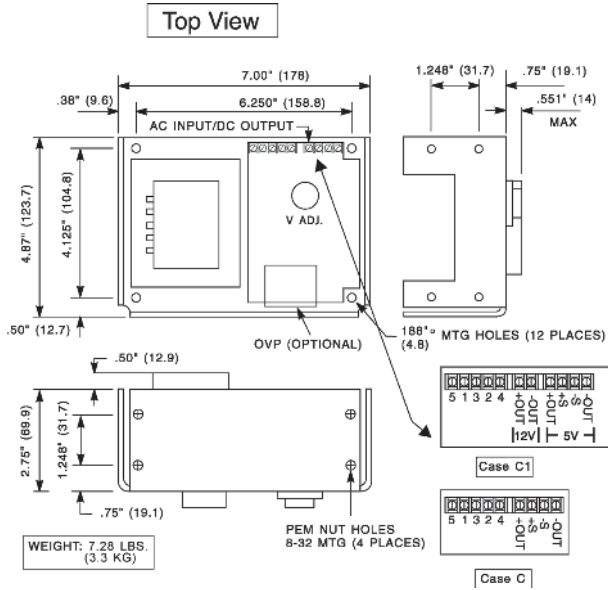

Cases C and C1

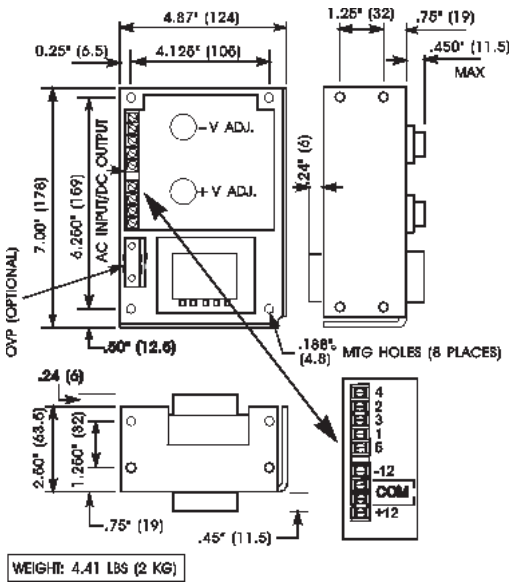

Case D

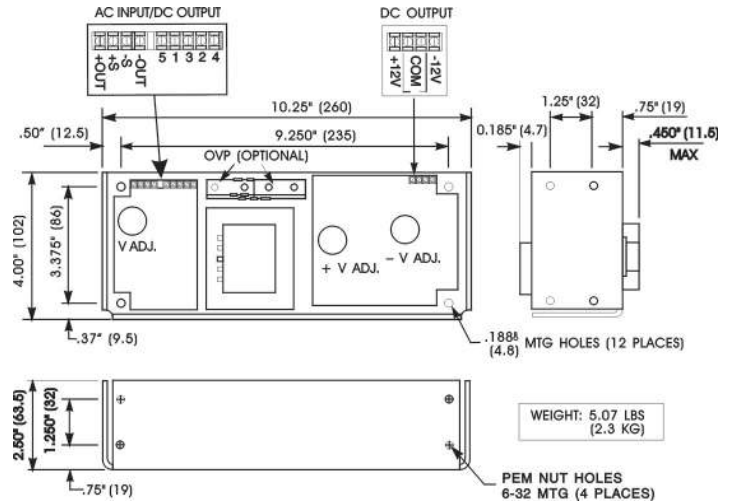

Case F

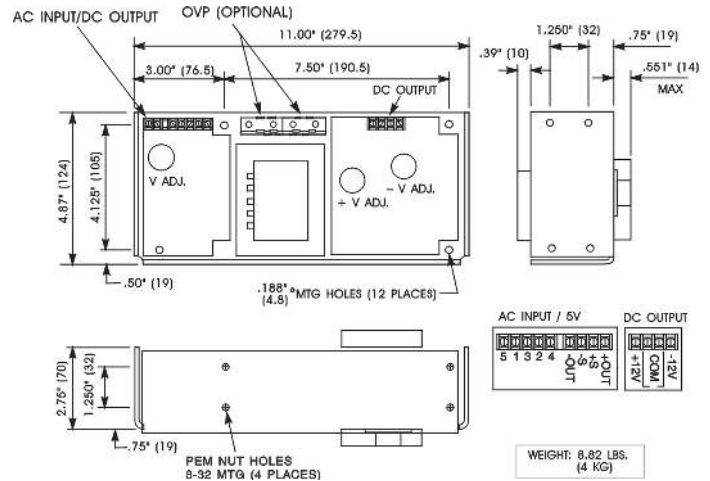

Case G2

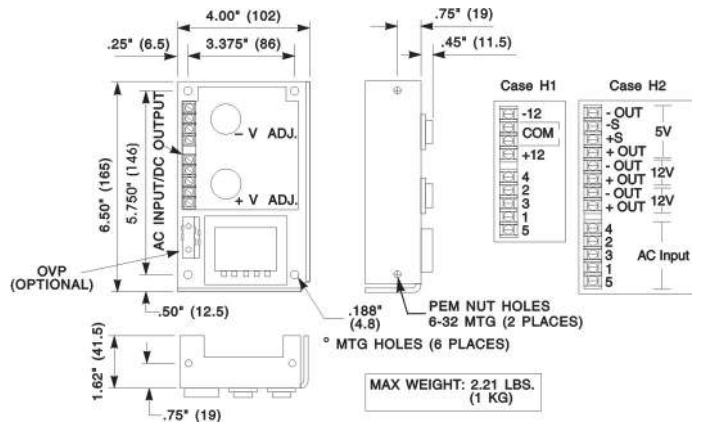

Cases H1 and H2

AC Input Jumper Connections

For use at:	100 Vac	120 Vac	220 Vac	230/240 Vac
Connect:	1-3, 2-4	1-3, 2-4	2-3	2-3
Apply AC:	1 & 5	1 & 4	1 & 5	1 & 4

Silver Line Dimensions (inches/mm)

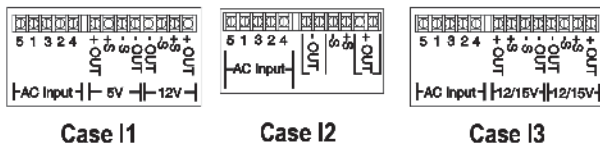
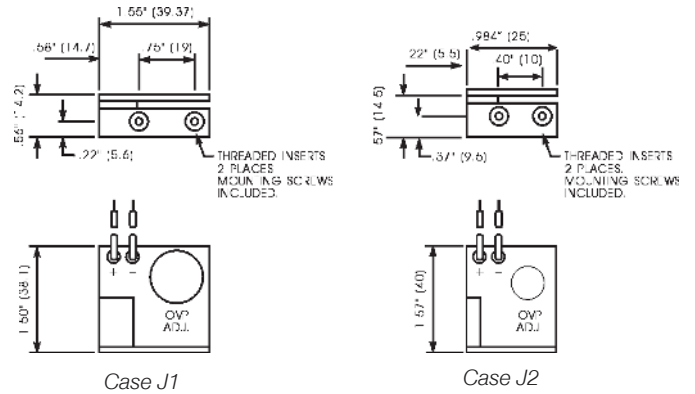
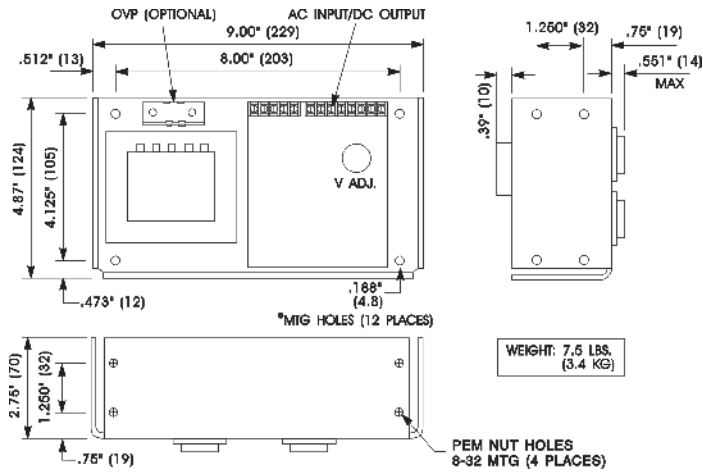

Cases I1, I2 and I3

Notes:

All dimensions in inches (mm). Dimensions may change and should not be used for construction purposes.

Be sure to specify the complete part number when ordering. Orders may be placed with your local SolaHD distributor.

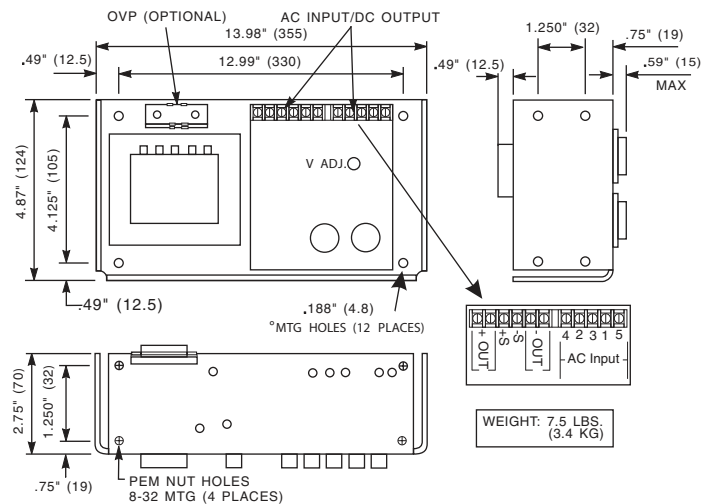

Case K

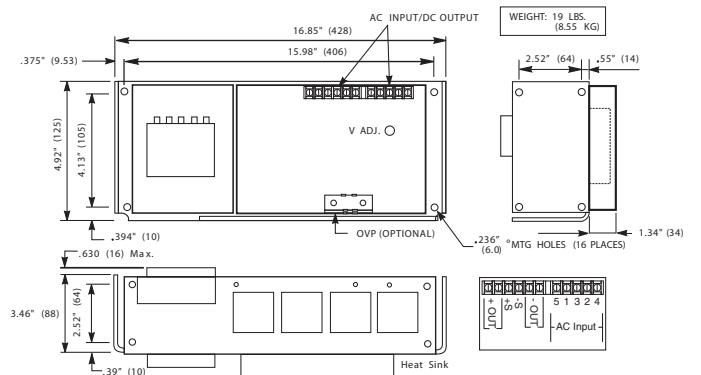

Case L