

ISL8003xDEMO1Z

Demonstration Boards

UG047  
Rev.2.00  
October 24, 2016

**Description**

The ISL80030xDEMO1Z and ISL80031xDEMO1Z boards are intended for use by individuals with requirements for point-of-load applications sourcing from 2.7V to 5.5V. The ISL8003xDEMO1Z boards are used to demonstrate the performance of the [ISL80030](#), [ISL80031](#), [ISL80030A](#), and [ISL80031A](#) low quiescent current mode converters.

These devices are offered in an 8 Ld 2mmx2mm DFN package with 1mm maximum height. The complete converter occupies less than 64mm<sup>2</sup> area.

**Specifications**

These boards have been configured and optimized for the following operating conditions:

- $V_{IN}$  = 2.7V to 5.5V
- $V_{OUT}$  = 1.8V
- $I_{OUT}$  = 3A (maximum)
- Up to 95% peak efficiency

**Key Features**

- Small, compact design
- $V_{IN}$  range of 2.7V to 5.5V
- $I_{OUT}$  maximum is 3A
- Negative current protection
- Internal soft-start and soft-stop
- Overcurrent and short-circuit protection
- Over-temperature/thermal protection

**References**

[ISL80030](#), [ISL80030A](#), [ISL80031](#), [ISL80031A](#) Datasheet

**Ordering Information**

PART NUMBER	DESCRIPTION
ISL80030DEMO1Z	3A, PWM, 1MHz demonstration board
ISL80031DEMO1Z	3A, PFM, 1MHz demonstration board
ISL80030ADEMO1Z	3A, PWM, 2MHz demonstration board
ISL80031ADEMO1Z	3A, PFM, 2MHz demonstration board

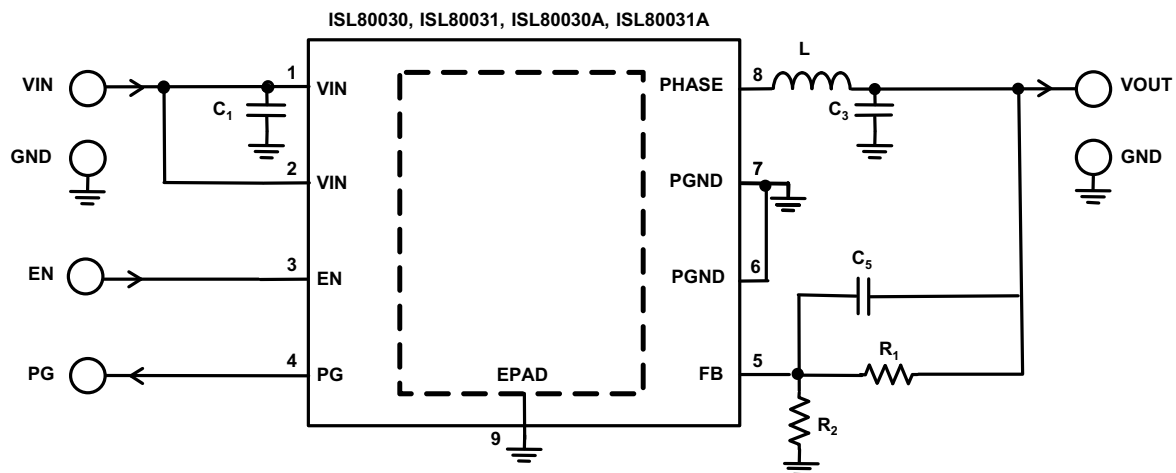

FIGURE 1. BLOCK DIAGRAM

## Test Steps

1. Ensure that the circuit is correctly connected to the supply and loads prior to applying any power.
2. Connect the bias supply to VIN, the plus terminal to VIN (TP1) and negative return to PGND (TP2).
3. Connect the output load to VO (TP3) and the negative return to PGND (TP4).
4. Turn on the power supply.
5. Verify the output voltage is 1.8V for  $V_{OUT}$ .

## Functional Description

The ISL8003xDEMO1Z boards provide a simple platform to evaluate performance of the ISL80030, ISL80031, ISL80030A and ISL80031A.

These devices are highly efficient, monolithic, synchronous step-down DC/DC converters that can deliver up to 3A of continuous output current from a 2.7V to 5.5V input supply. They use peak current mode control architecture to allow very low duty cycle operation. The devices operate at 1MHz (ISL80030, ISL80031) and 2MHz (ISL80030A and ISL80031A) switching

frequency, thereby providing superior transient response and allowing for the use of a small inductor.

## PCB Layout Guidelines

The PCB layout is a very important converter design step to make sure the designed converter works well. The power loop is composed of the output inductor L's, the output capacitor  $C_{OUT}$ , the PHASE pins and the PGND pin. It is necessary to make the power loop as small as possible and the connecting traces among them should be direct, short and wide. The switching node of the converter, the PHASE pins and the traces connected to the node are very noisy, so keep the voltage feedback trace away from these noisy traces. The input capacitor should be placed as close as possible to the VIN pin and the ground of the input and output capacitors should be connected as close as possible. The heat of the IC is mainly dissipated through the thermal pad. Maximizing the copper area connected to the thermal pad is preferable. In addition, a solid ground plane is helpful for better EMI performance. It is recommended to add at least 4 vias ground connection within the pad for the best thermal relief.



FIGURE 2. ISL80030DEMO1Z TOP SIDE



FIGURE 3. ISL80030DEMO1Z BOTTOM SIDE

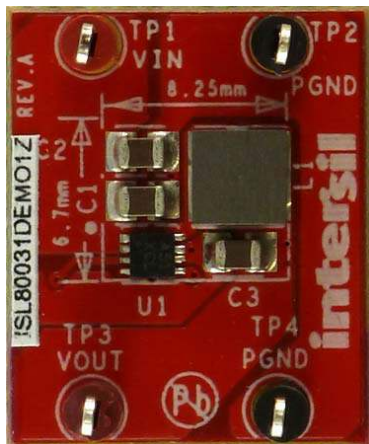

FIGURE 4. ISL80031DEMO1Z TOP SIDE



FIGURE 5. ISL80031DEMO1Z BOTTOM SIDE

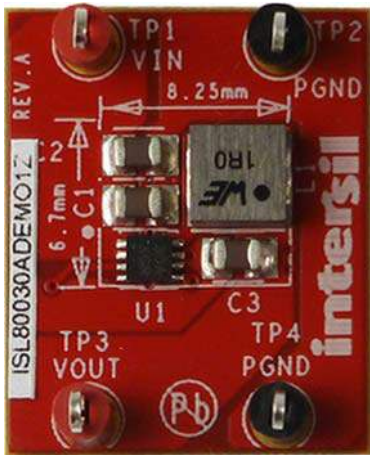

FIGURE 6. ISL80030ADEMO1Z TOP SIDE



FIGURE 7. ISL80030ADEMO1Z BOTTOM SIDE

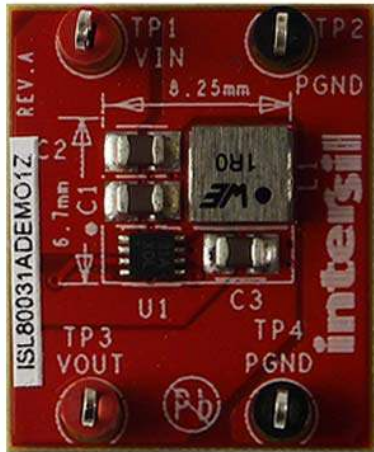

FIGURE 8. ISL80031ADEMO1Z TOP SIDE



FIGURE 9. ISL80031ADEMO1Z BOTTOM SIDE

## ISL8003xDEMO1Z Schematic

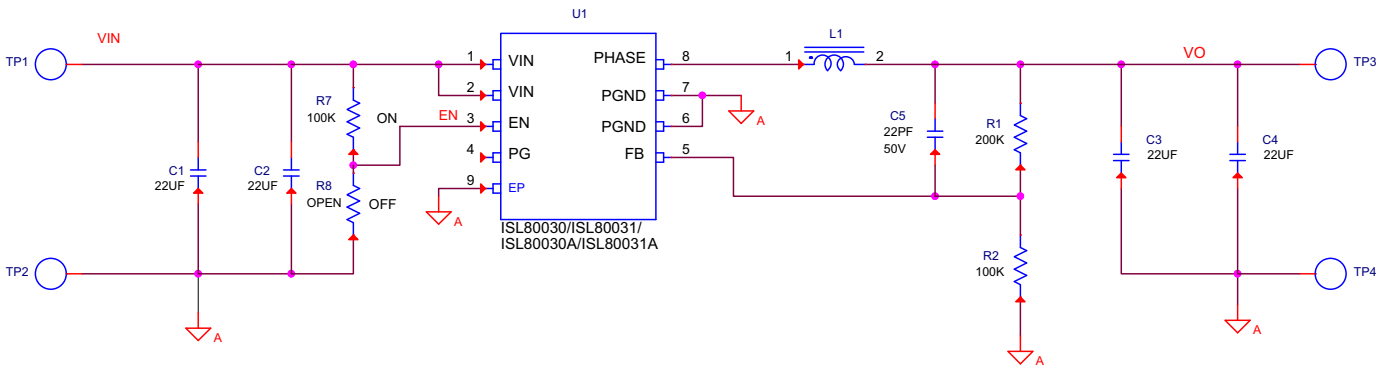

FIGURE 10. ISL8003xDEMO1Z SCHEMATIC

## Bill of Materials

QTY	UNITS	REFERENCE DESIGNATOR	DESCRIPTION	MANUFACTURER	MANUFACTURER PART
4	ea.	C1-C4	CAP, SMD, 0805, 22 $\mu$ F, 6.3V, 20%, X5R, ROHS	TDK	C2012X5R0J226M
1	ea.	C5	CAP, SMD, 0402, 22pF, 50V, 5%, NPO, ROHS	MURATA	GRM36COG220J050AQ
1	ea.	L1	COIL-PWR INDUCTOR, SMD, 4.1mm <sup>2</sup> , 1.0 $\mu$ H, 20%, 7.2A, ROHS	WE ( <a href="#">Note 1</a> )	744-383560 10
				TDK ( <a href="#">Note 1</a> )	SPM4020T-1R0M-LR
2	ea.	TP1, TP3	CONN-MINI TEST PT, VERTICAL, RED, ROHS	KEYSTONE	5000
2	ea.	TP2, TP4	CONN-MINI TEST PT, VERTICAL, BLK, ROHS	KEYSTONE	5001
1	ea.	U1	IC-3A, PWM, 1MHz BUCK REGULATOR, 8P, DFN, 2x2, ROHS	INTERSIL	ISL80030FRZ (ISL80030DEMO1Z)
			IC-3A, PFM, 1MHz BUCK REGULATOR, 8P, DFN, 2x2, ROHS	INTERSIL	ISL80031FRZ (ISL80031DEMO1Z)
			IC-3A, PWM, 2MHz BUCK REGULATOR, 8P, DFN, 2x2, ROHS	INTERSIL	ISL80030AFRZ (ISL80030ADEMO1Z)
			IC-3A, PFM, 2MHz BUCK REGULATOR, 8P, DFN, 2x2, ROHS	INTERSIL	ISL80031AFRZ (ISL80031ADEMO1Z)
2	ea.	R2, R7	RES, SMD, 0402, 100k, 1/16W, 1%, TF, ROHS	PANASONIC	ERJ2RKF1003
1	ea.	R1	RES, SMD, 0402, 200k, 1/16W, 1%, TF, ROHS	ROHM	MCR01MZPF2003
0	ea.	R8	RES, SMD, 0402, DNP, TF, ROHS		

## NOTE:

- Two manufacturers are provided as options for the inductor.

# Board Layout

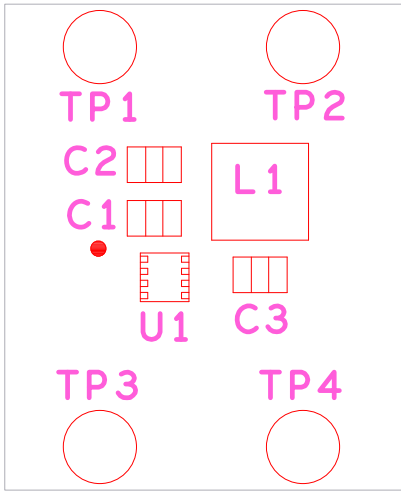

FIGURE 11. SILKSCREEN TOP

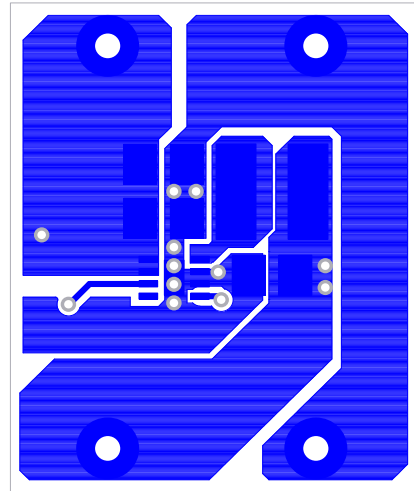

FIGURE 12. LAYER 1

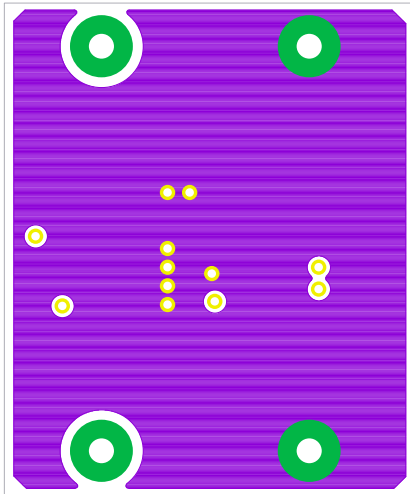

FIGURE 13. LAYER 2

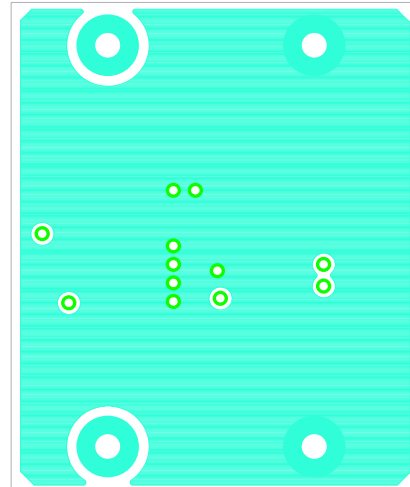

FIGURE 14. LAYER 3

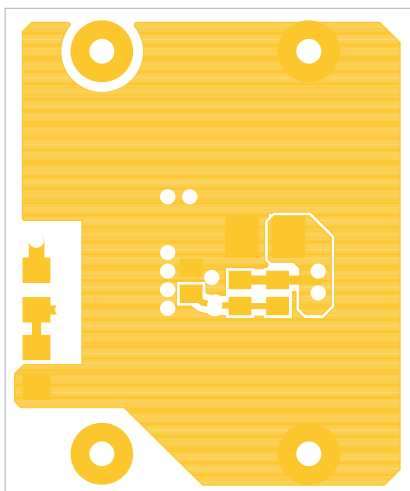

FIGURE 15. LAYER 4

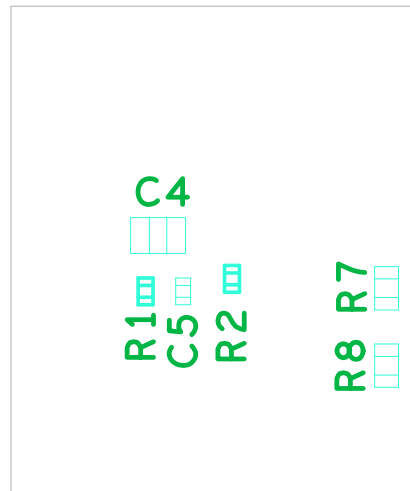

FIGURE 16. SILKSCREEN BOTTOM

## Typical Performance Curves

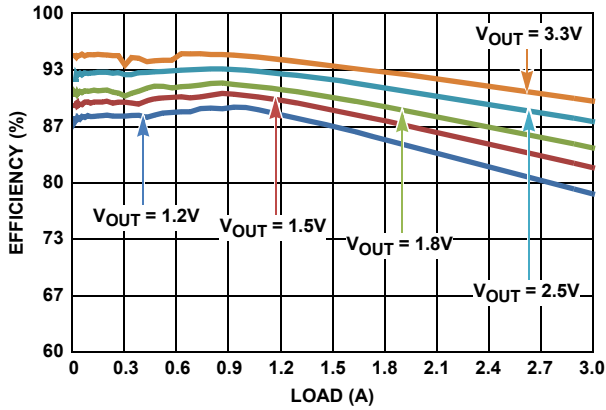

FIGURE 17. EFFICIENCY vs LOAD  
 $f_{SW} = 1\text{MHz}$ ,  $V_{IN} = 5\text{V}$ , PFM,  $T_A = +25^\circ\text{C}$

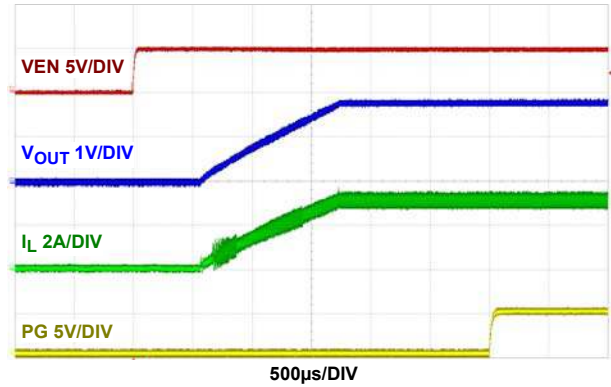

FIGURE 18. START-UP AT 3A LOAD  
 $V_{IN} = 5\text{V}$ , PWM,  $T_A = +25^\circ\text{C}$

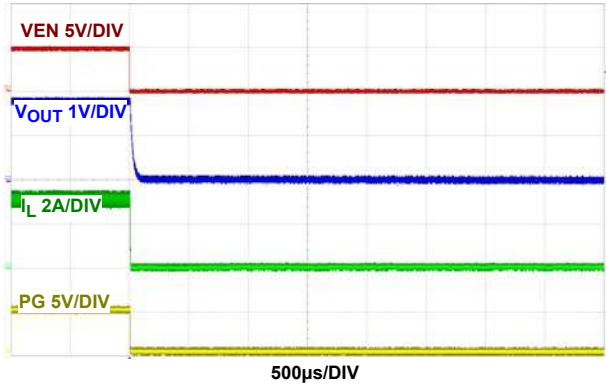

FIGURE 19. SHUTDOWN AT 3A LOAD  
 $V_{IN} = 5\text{V}$ , PWM,  $T_A = +25^\circ\text{C}$

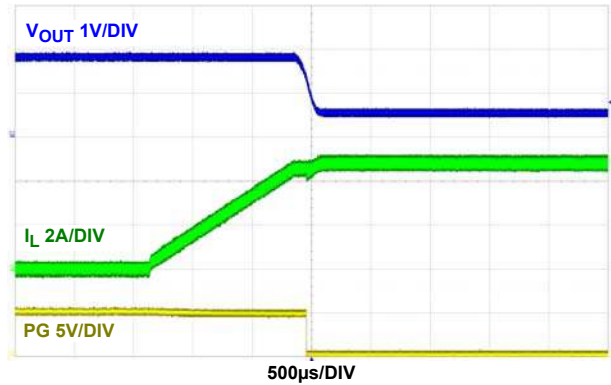

FIGURE 20. OVERCURRENT PROTECTION  
 $V_{IN} = 5\text{V}$ , PWM,  $T_A = +25^\circ\text{C}$

© Copyright Intersil Americas LLC 2015-2016. All Rights Reserved.  
 All trademarks and registered trademarks are the property of their respective owners.

Intersil Corporation reserves the right to make changes in circuit design, software and/or specifications at any time without notice. Accordingly, the reader is cautioned to verify that the document is current before proceeding.

For information regarding Intersil Corporation and its products, see [www.intersil.com](http://www.intersil.com)