

TECHNICAL DATA SHEET Preliminary

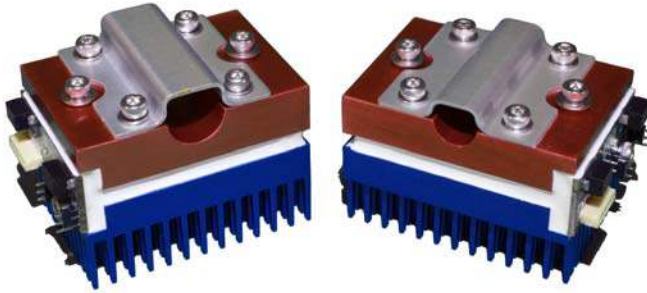

EHA-LXXAN1-R02-L1

Thermal Energy Harvesting Demo Unit
Water to Air

TYPICAL PERFORMANCE VALUES

	Min ΔT_{sys} (°C)			
	2.3V	3.3V	4.1V	5.0V
P at 10°C ΔT_{sys} (mW)	0.2	0.3	0.3	0.4
P at 60°C ΔT_{sys} (mW)	1.3	1.7	2.0	2.3

Marlow's EH series offers a range of source-to-application, thermoelectric-based energy harvesting systems for evaluation and testing. Each system integrates a Marlow electrically-matched, thermally- optimized custom thermoelectric generator and heat sink with a Linear Technology LTC series voltage step-up converter to provide the customer with tools and flexibility necessary to evaluate a wide range of test conditions. The EHA-LXXAN1-R02-L1 is designed to harvest power from the temperature difference between a warm fluid stream and the surrounding ambient air.

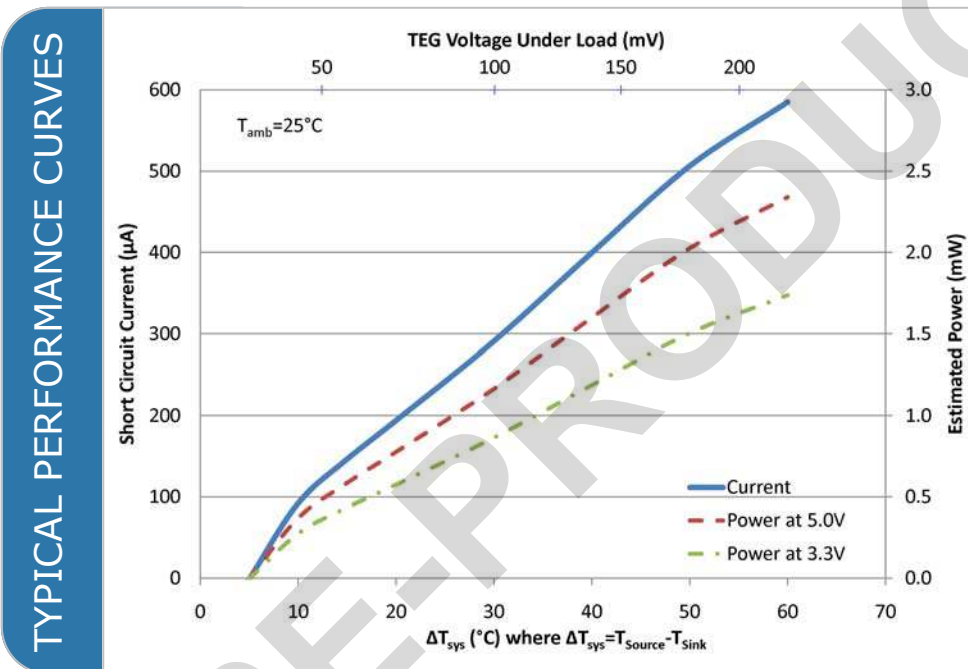

ORDERING OPTIONS

Model Number	Description
EHA-L37AN1-R02-L1	For pipe diameter 9.5mm [.375"]
EHA-L50AN1-R02-L1	For pipe diameter 12.7mm [0.5"]

CONTACT US:

For customer support or general questions please contact a local office below or consult our website for distributor information.

Marlow Industries, Inc.
10451 Vista Park Road
Dallas Texas 75238-1645
214-340-4900 (tel)
214-341-5212 (fax)
www.marlow.com

Marlow Industries Europe GmbH
Brunnenweg 19-21
64331 Weiterstadt
Germany
Tel.: +49 (0) 6150 5439 - 403
Fax: +49 (0) 6150 5439 - 400
info@marlow-europe.eu

Marlow Industries China, II-VI Technologies Beijing
A subsidiary of II-VI Incorporated
Rm 202, 1# Lize 2nd Middle Road
Wangjing, Chaoyang District
Beijing 100102 China
010-64398226 ext 105 (tel)
010-64399315 (fax)
info@iivibj.com

II-VI Japan Inc.
WBG Marive East 17F
2-6 Nakase, Mihama-ku
Chiba-Shi, Chiba 261-7117
Japan
81 43 297 2693 (tel)
81 43 297 3003 (fax)
center@ii-vi.co.jp
www.ii-vi.co.jp

II-VI Singapore Pte., Ltd.
Blk. 5012, Techplace II
#04-07 & 05-07/12, Ang Mo Kio Ave. 5
Singapore 569876
(65) 6481 8215 (tel)
(65) 6481 8702 (fax)
info@ii-vi.com.sg
www.ii-vi.com.sg

For more information please see:
<http://www.marlow.com/power-generators/energy-harvesting-solutions/>

MECHANICAL DRAWING

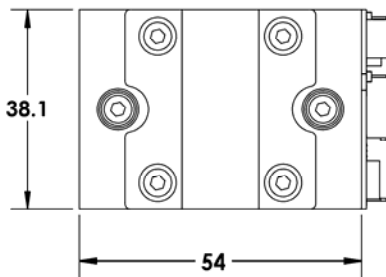
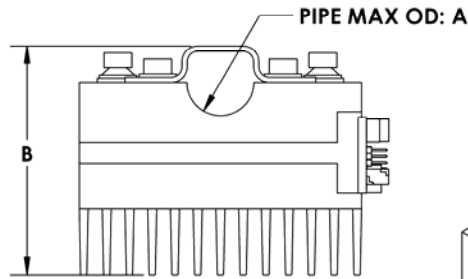

Dimensions are in Millimeters

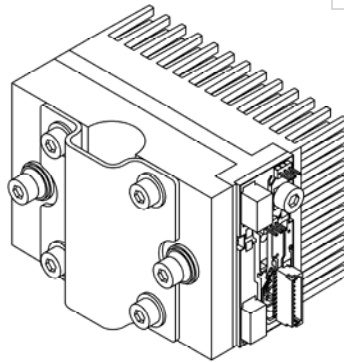

A (mm)	B (mm)	Model Number
9.5	41.0	EHA-L37AN1-R02-L1
12.7	44.0	EHA-L50AN1-R02-L1

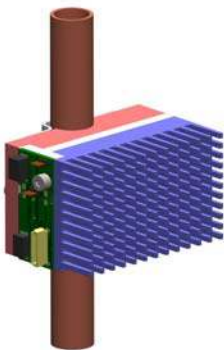

Ideal Orientation

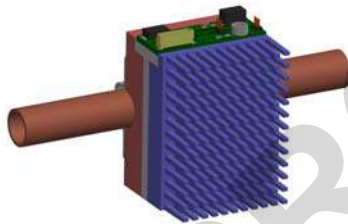

Good Orientation

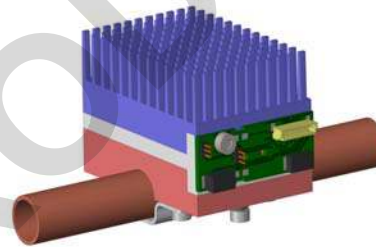

Acceptable Orientation

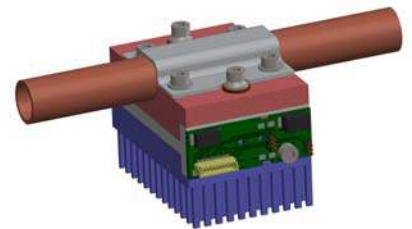

Poor Orientation

INSTALLATION:

Assembly should be mounted to hot fluid line using the provided mounting brackets and M3 bolts with a maximum torque of 5.0 in-lbs. A layer of graphite has been adhered to the pipe mounting surface on the EHA-LXXAN1-R02-L1 to ensure a good thermal contact between the mounting pipe and the EHA assembly. Performance will vary greatly with ambient conditions. For best results, insulate the fluid line feeding into the assembly and mount assembly in ideal orientation as shown. During installation, observe precautions for handling electrostatic sensitive devices.

CONTENTS:

1 EHA-LXXAN1-R02-L1 Assembly, 1
Wire Harness

OPERATION CAUTIONS:

For maximum reliability, continuous operation below 85°C is recommended. Do not attempt to disassemble without contacting a Marlow engineer. Doing so could result in permanent damage to the TG or other system components.

IMPORTANT NOTE:

Output from the EHA-LXXAN1-R02-L1 is strongly a function of heat source, ambient temperature, and electrical load downstream of the converter. Data given on this sheet is representative of typical system performance under steady-state flow and thermal conditions and is intended for selecting the appropriate EH series assembly. The data should not be taken as comprehensive or representative of every operating condition. For further information about or questions regarding the EHA-LXXAN1-R02-L1, please contact a Marlow applications engineer.

AVAILABLE MODIFICATIONS

Marlow can custom design the EH system to maximize power output, or to meet size, form factor, or temperature constraints for any thermal energy harvesting application. In special cases, Marlow can customize units to accommodate alternating temperature difference or a reverse temperature difference. Contact an application engineer for more information.

PIN FUNCTIONS

WIRE COLOR	FUNCTION	PIN
RED	V _{OUT}	1
BLACK	GND1	2
WHITE	VLDO	3
BROWN	GND2	4
GREY	PGD	5
GREEN	VSTORE	6
BLUE	T _{COLD}	7
ORANGE	T _{COLD}	8
YELLOW	T _{HOT}	9
PURPLE	T _{HOT}	10

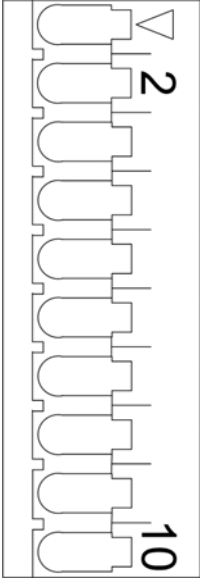
V_{OUT} (PIN 1)

Main output of the converter. The voltage at this pin is regulated to the voltage selected by VS1 and VS2. To select an output voltage, change the jumper locations at VS1 and VS2 on the board according to the V_{OUT} Options table below. Pin 1 may be connected to an auxiliary capacitor. A 220µF capacitor is already connected to this pin. See Application Notes sections of this datasheet for more information.

V_{OUT} OPTIONS

VS1	VS2	V _{OUT}
GND	GND	2.35V
VAUX	GND	3.3V
GND	VAUX	4.1V
VAUX	VAUX	5V

GND1 (PIN 2), GND2 (PIN 4)
Ground pin.

VLDO (PIN 3)

Output of the 2.2V Low Drop Out (LDO). The LTC3108 includes a low current LDO to provide a regulated 2.2V output for powering low power processors and other low power ICs. The LDO output is current limited to 4mA.

PGD (PIN 5)

Power good output that monitors the V_{OUT} voltage. The PGD output is designed to drive a microprocessor or other chip I/O and is not intended to drive a higher current load such as an LED. When V_{OUT} is within 7.5% of its programmed value, PGD will be pulled up to VLDO through a 1MΩ resistor. If V_{OUT} drops 9% below its programmed value PGD will go low.

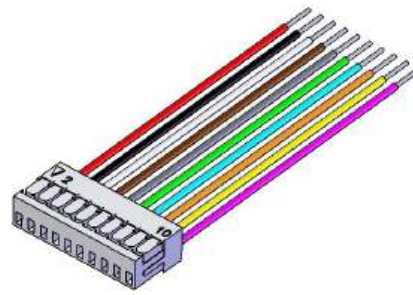

VSTORE (PIN 6)

Output for the storage capacitor or battery. The VSTORE output can be used to charge a large storage capacitor or rechargeable battery. The storage element on VSTORE can be used to power the system in the event that the input source is lost or is unable to provide the current demanded by V_{OUT} and VLDO output. A large capacitor may be connected from this pin to GND for powering the system in the event the input voltage is lost. It will be charged up to 5.25V. Note that it may take a long time to charge a larger capacitor, depending on the input energy available and the loading on V_{OUT} and LDO. Since the maximum current from VSTORE is limited to a few milliamps, it can safely be used to trickle-charge NiCd or NiMH rechargeable batteries for energy storage when the input voltage is lost. Note that the VSTORE capacitor cannot supply large pulse currents to V_{OUT}. Any pulse load on V_{OUT} must be handled by the V_{OUT} capacitor. If not used, this pin should be left open.

T_{HOT}, T_{COLD} (PINS 7-10)

Thermistor leads for hot side and cold side TEG temperatures. The temperature readings from the on-board thermistors monitor the hot side and cold side of the embedded TEG. In application, these temperatures will be different than the source and sink temperatures used to define the system temperature difference included in the performance plot. The following figure shows how thermal resistance on either side of the TEG can affect temperatures. It is recommended that the user place and monitor external thermocouples/thermistors/RTD's on both the heat source and heat sink (or ambient conditions) in addition to monitoring the on-board thermistors.

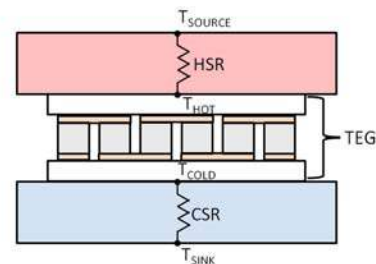

Manufacturer: GE Industrial Sensing (Thermometrics)

PN: A040A-UBCF16XF103X-A

Resistance at 25°C: 10 KΩ ± 0.20%

β 25/ 100: 3992 K ± 1%

$$T = \frac{(298K)(3992K)}{\ln(10k\Omega/R) \left(\frac{3992K}{\ln(10k\Omega/R)} - 298K \right)}$$

where R is the resistance of the thermistor that you want to measure and T is the temperature of the thermistor.

APPLICATION NOTES

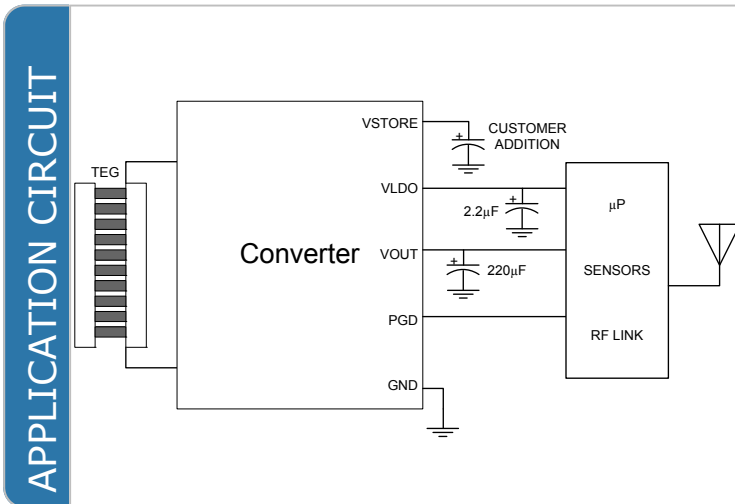
 V_{OUT} and VSTORE Capacitor

For pulsed load applications, the V_{OUT} capacitor should be sized to provide the necessary current when the load is pulsed on. The capacitor value required will be dictated by the load current, the duration of the load pulse, and the amount of voltage drop the circuit can tolerate. The capacitor must be rated for the voltage selected for V_{OUT} by VS1 and VS2.

$$C_{out} (\mu F) \geq \frac{I_{Load} (mA) t_{Pulse} (ms)}{\Delta V_{OUT} (V)}$$

ΔV_{OUT} is the maximum allowable voltage drop on V_{OUT} . Note that there must be enough energy available from the input voltage source for V_{OUT} to recharge the capacitor during the interval between load pulses. Reducing the duty cycle of the load pulse will allow operation with less input energy.

The VSTORE capacitor may be a very large value (thousands of microfarads or even Farads), to provide holdup at times when the input power may be lost. Note that this capacitor may charge to 5.25V (regardless of the settings for V_{OUT}), so ensure that the holdup capacitor has a working voltage rating of at least 5.5V at the temperature for which it will be used. The VSTORE capacitor can be sized using the following:

$$C_{Store} \geq \frac{[6\mu A + I_Q + I_{LDO} + (I_{Burst} t) f] T_{Store}}{5.25 - V_{OUT}}$$

where $6\mu A$ is the quiescent current of the LTC3108, I_Q is the load on V_{OUT} in between bursts, I_{LDO} is the load on the LDO between bursts, I_{BURST} is the total load during the burst, t is the duration of the burst, f is the frequency of the burst, T_{STORE} is the storage time required, and V_{OUT} is the output voltage required. Note that for a programmed output voltage of 5V, the VSTORE capacitor cannot provide any beneficial storage time. Storage capacitors requiring voltage balancing are not recommended due to the current draw of the balancing resistor.

In many pulsed load applications, the duration, magnitude and frequency of the load current bursts are known and fixed. In these cases the charge current required from the LTC3108 to support average load must be calculated, by the following:

$$I_{CHG} \geq I_Q + \frac{I_{Burst} t}{T}$$

where I_Q is the sleep current on V_{OUT} required by the external circuitry in between bursts (including cap leakage), I_{BURST} is the total load current during the burst, t is the time duration of the burst and T is the period of the transmit burst rate (essentially the time between bursts).

SET-UP TIPS

To assess your thermal interface between the EHA-LXXAN1-R02-L1 and your hot fluid line and estimate your expected maximum current, follow these procedures to measure your short circuit current:

1. Connect a 200 Ω resistor in series between pins 1 and 2.
2. Connect a voltmeter across the 200 Ω resistor.
3. Bring the hot side of the assembly to the desired temperature by raising the source temperature and monitoring the hot side thermistor via pins 9 and 10 on the wire harness. Note that pins 9 and 10 measure the hot side of the TEG and not the source temperature. There could be several degrees difference between T_{SOURCE} and T_{HOT} , so Marlow recommends mounting a thermocouple to the source to independently monitor T_{SOURCE} . If the discrepancy is greater than 5 $^{\circ}C$, there may be thermal interface or mounting issues and Marlow recommends remounting the EHA-LXXAN1-R02-L1.
4. Allow the assembly temperature to stabilize and measure the voltage drop across the resistor.
5. Convert the voltage to a current using $I=V/R$.
6. Check that the short circuit current matches closely with the performance curve plot on page 1.

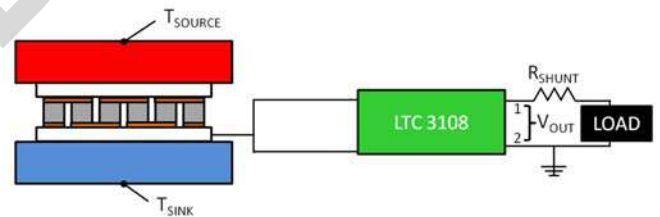

To evaluate operation under electrical load conditions use the following procedure:

1. Connect the load/battery/capacitor/resistor between pins 1 and 2 (See image below).
2. Connect a voltmeter across the load.
3. If possible, connect a small resistor or current shunt in series between pin 1 and the load/battery/capacitor/resistor between pins 1 and 2. Use this shunt to calculate current out of V_{OUT} .
4. Bring the hot side of the assembly to the desired temperature by raising the source temperature and monitoring the hot side thermistor via pins 9 and 10 on the wire harness.
5. Measure the voltage drop across the load device/resistor and the current from the shunt. Use voltage and current to calculate power.
6. Check the calculated power against the performance curve plot on page 1.

The EHA-LXXAN1-R02-L1 is now ready for further evaluation in your application. If you have any questions on this test procedure or how to test the unit in your application, please contact a Marlow application engineer for further assistance. For more information, please refer to the Contact Us section of this datasheet.