

SUMMARY



Image is for illustrative purpose only

Wires

Low voltage 6

Series 4B
Termination type Male solder
IP rating 50
AWG wire size 22.00 - 14.00
Cable Ø 0.00 - 0.00 mm
Status active

Download

[Request a quote](#)

[Catalog](#)

TECHNICAL DETAILS

Mechanics

Shell Style/Model FA*: Fixed plug, non-latching, nut fixing
Keying 2 keys (alpha=30, plug: male contacts, receptacle: female contacts)
Housing Material Brass (chrome plated [SAE AMS 2460]) shell and collet nut, nickel plated [SAE AMS QQ N 290] brass latch sleeve and mid pieces
Weight 81.40 g

Performance

Configuration 4B.306 : 6 Low Voltage
Insulator L: PEEK (UL 94 / V-0/1.5)
Rated Current 24 Amps

Specifications

Contact Type: Solder
Contact Dia.: 2 mm (0.079in)
Bucket Dia.: 1.8 mm (0.071in)
Max. Solid Conductor: 1.5 mm² (AWG 14)
Max. Stranded Conductor: 1.5 mm² (AWG 16)
R (max): 3.3 mOhm
Vtest (contact-shell): 1750 V (AC), 2500 V (DC)
Vtest (contact-contact): 2000 V (AC), 2850 V (DC)

LEMO products and services are provided "as is". LEMO makes no warranties or representations with regard to LEMO product & services or use of them, express, implied or statutory, including for accuracy, completeness, or security. The user is fully responsible for his products and applications using LEMO components.

Others

Endurance (Shell): 5000
 Temp (min / max): -55°C / +250°C
 Humidity (max): <=95% [at 60 deg C / 140 F]
 Vibration: 15 g [10 Hz - 2000 Hz]
 Shock Resistance: 100 g [6 ms]
 Climatical Category: 50/175/21
 Shielding (min): 75 dB (10 MHz)
 Shielding (min): 40 dB (1 GHz)
 Salt Spray Corrosion: >1000 hr

DRAWINGS

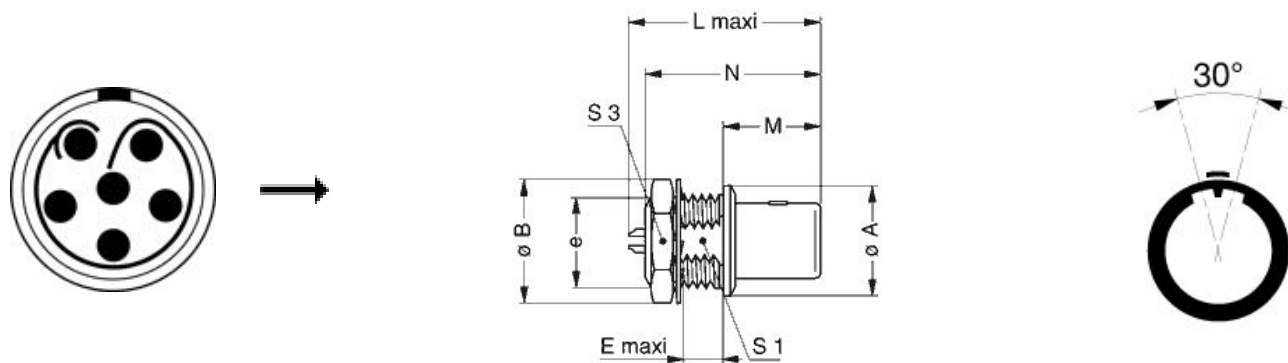

Dimensions















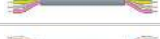







	A	B	E	L	M	N	S1	S3	e
mm.	29	34	6.8	37.1	20.5	34.7	23.5	30	M25x1.0
in.	1,14	1,34	0,27	1,46	0,81	1,37	0,93	1,18	

RECOMMENDED BY LEMO

Tools

LEMO products and services are provided "as is". LEMO makes no warranties or representations with regard to LEMO product & services or use of them, express, implied or statutory, including for accuracy, completeness, or security. The user is fully responsible for his products and applications using LEMO components.

Cables

CMN.06.T18.070PGZE		Grey	
CMN.06.T18.070PNZE			
CMN.06.T20.062PGZE		Grey	
CMN.06.T20.062PNZE			
CMN.06.T20.062QGZE	TPR (medical)	Grey	
CMN.06.T26.037QGZE	TPR (medical)	Grey	
CMN.06.T28.031PGCE	PVC	GREY	
CMN.06.T28.031PGZE		Grey	
CMN.06.T28.031PNCE	PVC	Black	
CMN.06.T28.031PNZE			
CMN.06.T28.042QBCE	TPR (medical)		
CMN.06.T28.044PGZE		Grey	
CMN.06.T28.044PNZE			
106220	PVC	Black	
106240	PTFE	White	
12080	PVC	Grey	
160140	PVC	Grey	
160240	PVC	Black	
160260	PVC	Black	
260250	PVC	Grey	
360500	PVC	Grey	
360750	PVC	Grey	
460150	PVC	Grey	
60260	PTFE	White	
6280	PVC	Black	

LEMO products and services are provided "as is". LEMO makes no warranties or representations with regard to LEMO product & services or use of them, express, implied or statutory, including for accuracy, completeness, or security. The user is fully responsible for his products and applications using LEMO components.