

74VCXH16373

Low-Voltage 1.8/2.5/3.3 V 16-Bit Transparent Latch With 3.6 V-Tolerant Inputs and Outputs (3-State, Non-Inverting)

The 74VCXH16373 is an advanced performance, non-inverting 16-bit transparent latch. It is designed for very high-speed, very low-power operation in 1.8 V, 2.5 V or 3.3 V systems. The VCXH16373 is byte controlled, with each byte functioning identically, but independently. Each byte has separate Output Enable and Latch Enable inputs. These control pins can be tied together for full 16-bit operation.

When operating at 2.5 V (or 1.8 V) the part is designed to tolerate voltages it may encounter on either inputs or outputs when interfacing to 3.3 V busses. It is guaranteed to be overvoltage tolerant to 3.6 V.

The 74VCXH16373 contains 16 D-type latches with 3-state 3.6 V-tolerant outputs. When the Latch Enable (LEn) inputs are HIGH, data on the Dn inputs enters the latches. In this condition, the latches are transparent, (a latch output will change state each time its D input changes). When LE is LOW, the latch stores the information that was present on the D inputs a setup time preceding the HIGH-to-LOW transition of LE. The 3-state outputs are controlled by the Output Enable (\overline{OE}) inputs. When \overline{OE} is LOW, the outputs are enabled. When \overline{OE} is HIGH, the standard outputs are in the high impedance state, but this does not interfere with new data entering into the latches. The data inputs include active bushold circuitry, eliminating the need for external pullup resistors to hold unused or floating inputs at a valid logic state.

Features

- Designed for Low Voltage Operation: $V_{CC} = 1.65\text{ V} - 3.6\text{ V}$
- 3.6 V Tolerant Inputs and Outputs
- High Speed Operation: 3.0 ns max for 3.0 V to 3.6 V
3.9 ns max for 2.3 V to 2.7 V
6.8 ns max for 1.65 V to 1.95 V
- Static Drive: $\pm 24\text{ mA}$ Drive at 3.0 V
 $\pm 18\text{ mA}$ Drive at 2.3 V
 $\pm 6\text{ mA}$ Drive at 1.65 V
- Supports Live Insertion and Withdrawal
- Includes Active Bushold to Hold Unused or Floating Inputs at a Valid Logic State
- I_{OFF} Specification Guarantees High Impedance When $V_{CC} = 0\text{ V}^*$
- Near Zero Static Supply Current in All Three Logic States (20 μA) Substantially Reduces System Power Requirements
- Latchup Performance Exceeds $\pm 250\text{ mA}$ @ 125°C
- ESD Performance: Human Body Model >2000 V
Machine Model >200 V
- Pb-Free Package is Available**

*To ensure the outputs activate in the 3-state condition, the output enable pins should be connected to V_{CC} through a pull-up resistor. The value of the resistor is determined by the current sinking capability of the output connected to the \overline{OE} pin.



ON Semiconductor®

<http://onsemi.com>

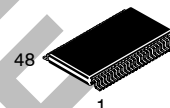

TSSOP-48
DT SUFFIX
CASE 1201

MARKING DIAGRAM

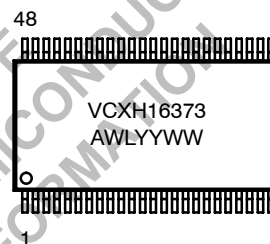

A = Assembly Location
WL = Wafer Lot
YY = Year
WW = Work Week

PIN NAMES

Pins	Function
\overline{OE} n	Output Enable Inputs
LEn	Latch Enable Inputs
D0-D15	Inputs
O0-O15	Outputs

ORDERING INFORMATION

Device	Package	Shipping [†]
74VCXH16373DT	TSSOP	39 / Rail
74VCXH16373DTR	TSSOP	2500/Tape & Reel
74VCXH16373DTRG	TSSOP (Pb-Free)	2500/Tape & Reel

[†]For information on tape and reel specifications, including part orientation and tape sizes, please refer to our Tape and Reel Packaging Specification Brochure, BRD8011/D.

**For additional information on our Pb-Free strategy and soldering details, please download the ON Semiconductor Soldering and Mounting Techniques Reference Manual, SOLDERRM/D.

74VCXH16373

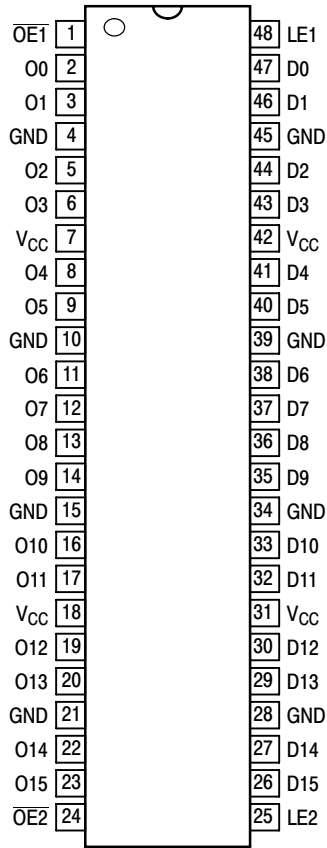

Figure 1. 48-Lead Pinout (Top View)

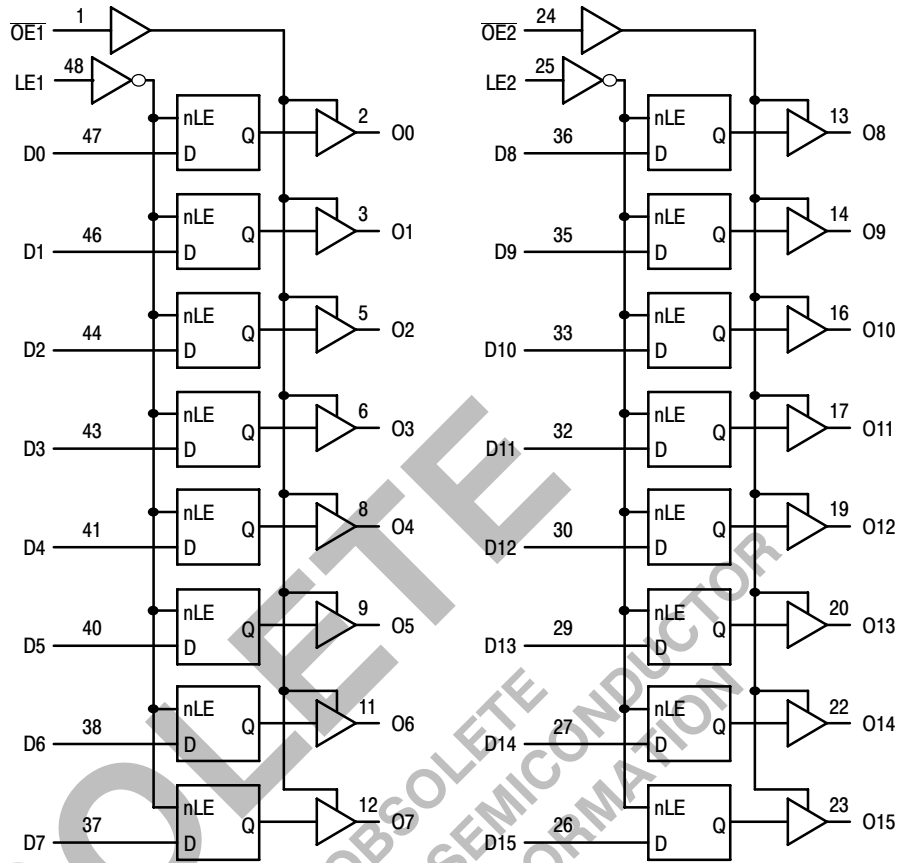

Figure 2. Logic Diagram

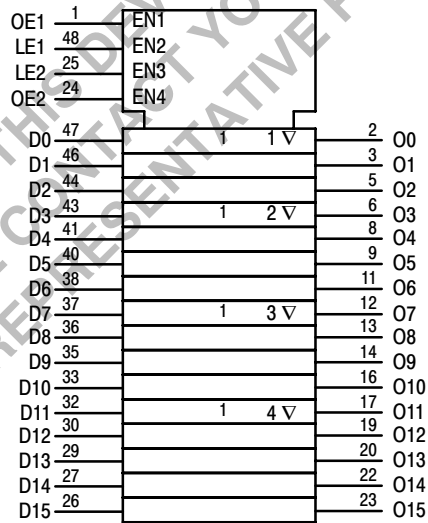

Figure 3. IEC Logic Diagram

74VCXH16373

TRUTH TABLE

Inputs			Outputs	Inputs			Outputs
LE1	OE1	D0:7	O0:7	LE2	OE2	D8:15	O8:15
X	H	X	Z	X	H	X	Z
H	L	L	L	H	L	L	L
H	L	H	H	H	L	H	H
L	L	X	O0	L	L	X	O0

H = High Voltage Level

L = Low Voltage Level

Z = High Impedance State

X = High or Low Voltage Level and Transitions Are Acceptable, for I_{CC} reasons, DO NOT FLOAT Inputs.

O0 = No Change.

ABSOLUTE MAXIMUM RATINGS

Symbol	Parameter	Value	Condition	Unit
V_{CC}	DC Supply Voltage	-0.5 to +4.6		V
V_I	DC Input Voltage	$-0.5 \leq V_I \leq +4.6$		V
V_O	DC Output Voltage	$-0.5 \leq V_O \leq +4.6$	Output in 3-State	V
		$-0.5 \leq V_O \leq V_{CC} + 0.5$	Note 1; Outputs Active	V
I_{IK}	DC Input Diode Current	-50	$V_I < GND$	mA
I_{OK}	DC Output Diode Current	-50	$V_O < GND$	mA
		+50	$V_O > V_{CC}$	mA
I_O	DC Output Source/Sink Current	± 50		mA
I_{CC}	DC Supply Current Per Supply Pin	± 100		mA
I_{GND}	DC Ground Current Per Ground Pin	± 100		mA
T_{STG}	Storage Temperature Range	-65 to +150		°C

Stresses exceeding Maximum Ratings may damage the device. Maximum Ratings are stress ratings only. Functional operation above the Recommended Operating Conditions is not implied. Extended exposure to stresses above the Recommended Operating Conditions may affect device reliability.

- I_O absolute maximum rating must be observed.

RECOMMENDED OPERATING CONDITIONS

Symbol	Parameter	Min	Typ	Max	Unit	
V_{CC}	Supply Voltage	Operating	1.65	3.3	3.6	V
		Data Retention Only	1.2	3.3	3.6	
V_I	Input Voltage	-0.3		3.6	V	
V_O	Output Voltage	(Active State)	0		V_{CC}	V
		(3-State)	0		3.6	
I_{OH}	HIGH Level Output Current, $V_{CC} = 3.0\text{ V} - 3.6\text{ V}$			-24	mA	
I_{OL}	LOW Level Output Current, $V_{CC} = 3.0\text{ V} - 3.6\text{ V}$			24	mA	
I_{OH}	HIGH Level Output Current, $V_{CC} = 2.3\text{ V} - 2.7\text{ V}$			-18	mA	
I_{OL}	LOW Level Output Current, $V_{CC} = 2.3\text{ V} - 2.7\text{ V}$			18	mA	
I_{OH}	HIGH Level Output Current, $V_{CC} = 1.65\text{ V} - 1.95\text{ V}$			-6	mA	
I_{OL}	LOW Level Output Current, $V_{CC} = 1.65\text{ V} - 1.95\text{ V}$			6	mA	
T_A	Operating Free-Air Temperature	-40		+85	°C	
$\Delta t/\Delta V$	Input Transition Rise or Fall Rate, V_{IN} from 0.8 V to 2.0 V, $V_{CC} = 3.0\text{ V}$	0		10	ns/V	

74VCXH16373

DC ELECTRICAL CHARACTERISTICS

Symbol	Characteristic	Condition	T _A = -40°C to +85°C		Unit
			Min	Max	
V _{IH}	HIGH Level Input Voltage (Note 2)	1.65 V ≤ V _{CC} < 2.3 V	0.65 x V _{CC}		V
		2.3 V ≤ V _{CC} ≤ 2.7 V	1.6		
		2.7 V < V _{CC} ≤ 3.6 V	2.0		
V _{IL}	LOW Level Input Voltage (Note 2)	1.65 V ≤ V _{CC} < 2.3 V		0.35 x V _{CC}	V
		2.3 V ≤ V _{CC} ≤ 2.7 V		0.7	
		2.7 V < V _{CC} ≤ 3.6 V		0.8	
V _{OH}	HIGH Level Output Voltage	1.65 V ≤ V _{CC} ≤ 3.6 V; I _{OH} = -100 μA	V _{CC} - 0.2		V
		V _{CC} = 1.65 V; I _{OH} = -6 mA	1.25		
		V _{CC} = 2.3 V; I _{OH} = -6 mA	2.0		
		V _{CC} = 2.3 V; I _{OH} = -12 mA	1.8		
		V _{CC} = 2.3 V; I _{OH} = -18 mA	1.7		
		V _{CC} = 2.7 V; I _{OH} = -12 mA	2.2		
		V _{CC} = 3.0 V; I _{OH} = -18 mA	2.4		
V _{OL}	LOW Level Output Voltage	1.65 V ≤ V _{CC} ≤ 3.6 V; I _{OL} = 100 μA		0.2	V
		V _{CC} = 1.65 V; I _{OL} = 6 mA		0.3	
		V _{CC} = 2.3 V; I _{OL} = 12 mA		0.4	
		V _{CC} = 2.3 V; I _{OL} = 18 mA		0.6	
		V _{CC} = 2.7 V; I _{OL} = 12 mA		0.4	
		V _{CC} = 3.0 V; I _{OL} = 18 mA		0.4	
		V _{CC} = 3.0 V; I _{OL} = 24 mA		0.55	
I _I	Input Leakage Current	1.65 V ≤ V _{CC} ≤ 3.6 V; 0V ≤ V _I ≤ 3.6 V		±5.0	μA
I _{I(HOLD)}	Minimum Bushold Input Current	V _{CC} = 3.0 V, V _{IN} = 0.8 V	75		μA
		V _{CC} = 3.0 V, V _{IN} = 2.0 V	-75		
		V _{CC} = 2.3 V, V _{IN} = 0.7 V	45		
		V _{CC} = 2.3 V, V _{IN} = 1.6 V	-45		
		V _{CC} = 1.65 V, V _{IN} = 0.57 V	25		
		V _{CC} = 1.65 V, V _{IN} = 1.07 V	-25		
I _{I(OD)}	Minimum Bushold Over-Drive Current Needed to Change State	V _{CC} = 3.6 V, (Note 3)	450		μA
		V _{CC} = 3.6 V, (Note 4)	-450		
		V _{CC} = 2.7 V, (Note 3)	300		
		V _{CC} = 2.7 V, (Note 4)	-300		
		V _{CC} = 1.95 V, (Note 3)	200		
		V _{CC} = 1.95 V, (Note 4)	-200		
I _{OZ}	3-State Output Current	1.65 V ≤ V _{CC} ≤ 3.6 V; 0 V ≤ V _O ≤ 3.6 V; V _I = V _{IH} or V _{IL}		±10	μA
I _{OFF}	Power-Off Leakage Current	V _{CC} = 0 V; V _I or V _O = 3.6 V		10	μA
I _{CC}	Quiescent Supply Current (Note 5)	1.65 V ≤ V _{CC} ≤ 3.6 V; V _I = GND or V _{CC}		20	μA
		1.65 V ≤ V _{CC} ≤ 3.6 V; 3.6 V ≤ V _I , V _O ≤ 3.6 V		±20	μA
ΔI _{CC}	Increase in I _{CC} per Input	2.7 V < V _{CC} ≤ 3.6 V; V _{IH} = V _{CC} - 0.6 V		750	μA

2. These values of V_I are used to test DC electrical characteristics only.

3. An external driver must source at least the specified current to switch from LOW-to-HIGH.

4. An external driver must source at least the specified current to switch from HIGH-to-LOW.

5. Outputs disabled or 3-state only.

74VCXH16373

AC CHARACTERISTICS (Note 6; $t_R = t_F = 2.0$ ns; $C_L = 30$ pF; $R_L = 500$ Ω)

Symbol	Parameter	Waveform	$T_A = -40^\circ\text{C to } +85^\circ\text{C}$						Unit
			$V_{CC} = 3.0$ V to 3.6 V		$V_{CC} = 2.3$ V to 2.7 V		$V_{CC} = 1.65$ V to 1.95 V		
			Min	Max	Min	Max	Min	Max	
t_{PLH} t_{PHL}	Propagation Delay Dn-to-On	1	0.8 0.8	3.0 3.0	1.0 1.0	3.4 3.4	1.5 1.5	6.8 6.8	ns
t_{PLH} t_{PHL}	Propagation Delay LE-to-On	1	0.8 0.8	3.0 3.0	1.0 1.0	3.9 3.9	1.5 1.5	7.8 7.8	ns
t_{PZH} t_{PZL}	Output Enable Time to High and Low Level	2	0.8 0.8	3.5 3.5	1.0 1.0	4.6 4.6	1.5 1.5	9.2 9.2	ns
t_{PHZ} t_{PLZ}	Output Disable Time From High and Low Level	2	0.8 0.8	3.5 3.5	1.0 1.0	3.8 3.8	1.5 1.5	6.8 6.8	ns
t_s	Setup Time, High or Low Dn-to-LE	3	1.5		1.5		2.5		ns
t_h	Hold Time, High or Low Dn-to-LE	3	1.0		1.0		1.0		ns
t_w	LE Pulse Width, High	3	1.5		1.5		4.0		ns
t_{OSHL} t_{OSLH}	Output-to-Output Skew (Note 7)			0.5 0.5		0.5 0.5		0.75 0.75	ns

6. For $C_L = 50$ pF, add approximately 300 ps to the AC maximum specification.

7. Skew is defined as the absolute value of the difference between the actual propagation delay for any two separate outputs of the same device. The specification applies to any outputs switching in the same direction, either HIGH-to-LOW (t_{OSHL}) or LOW-to-HIGH (t_{OSLH}); parameter guaranteed by design.

AC CHARACTERISTICS ($t_R = t_F = 2.0$ ns; $C_L = 50$ pF; $R_L = 500$ Ω)

Symbol	Parameter	Waveform	$T_A = -40^\circ\text{C to } +85^\circ\text{C}$				Unit
			$V_{CC} = 3.0$ V to 3.6 V		$V_{CC} = 2.7$ V		
			Min	Max	Min	Max	
t_{PLH} t_{PHL}	Propagation Delay Dn-to-On	4	1.0 1.0	3.6 3.6		4.3 4.3	ns
t_{PLH} t_{PHL}	Propagation Delay LE-to-On	4	1.0 1.0	3.9 3.9		4.6 4.6	ns
t_{PZH} t_{PZL}	Output Enable Time to High and Low Level	5	1.0 1.0	4.7 4.7		5.7 5.7	ns
t_{PHZ} t_{PLZ}	Output Disable Time From High and Low Level	5	1.0 1.0	4.1 4.1		4.5 4.5	ns
t_{OSHL} t_{OSLH}	Output-to-Output Skew (Note 8)			0.5 0.5		0.5 0.5	ns

8. Skew is defined as the absolute value of the difference between the actual propagation delay for any two separate outputs of the same device. The specification applies to any outputs switching in the same direction, either HIGH-to-LOW (t_{OSHL}) or LOW-to-HIGH (t_{OSLH}); parameter guaranteed by design.

DYNAMIC SWITCHING CHARACTERISTICS

Symbol	Characteristic	Condition	$T_A = +25^\circ\text{C}$	
			Typ	Unit
V _{OLP}	Dynamic LOW Peak Voltage (Note 9)	$V_{CC} = 1.8\text{ V}, C_L = 30\text{ pF}, V_{IH} = V_{CC}, V_{IL} = 0\text{ V}$	0.25	V
		$V_{CC} = 2.5\text{ V}, C_L = 30\text{ pF}, V_{IH} = V_{CC}, V_{IL} = 0\text{ V}$	0.6	
		$V_{CC} = 3.3\text{ V}, C_L = 30\text{ pF}, V_{IH} = V_{CC}, V_{IL} = 0\text{ V}$	0.8	
V _{OLV}	Dynamic LOW Valley Voltage (Note 9)	$V_{CC} = 1.8\text{ V}, C_L = 30\text{ pF}, V_{IH} = V_{CC}, V_{IL} = 0\text{ V}$	-0.25	V
		$V_{CC} = 2.5\text{ V}, C_L = 30\text{ pF}, V_{IH} = V_{CC}, V_{IL} = 0\text{ V}$	-0.6	
		$V_{CC} = 3.3\text{ V}, C_L = 30\text{ pF}, V_{IH} = V_{CC}, V_{IL} = 0\text{ V}$	-0.8	
V _{OHV}	Dynamic HIGH Valley Voltage (Note 10)	$V_{CC} = 1.8\text{ V}, C_L = 30\text{ pF}, V_{IH} = V_{CC}, V_{IL} = 0\text{ V}$	1.5	V
		$V_{CC} = 2.5\text{ V}, C_L = 30\text{ pF}, V_{IH} = V_{CC}, V_{IL} = 0\text{ V}$	1.9	
		$V_{CC} = 3.3\text{ V}, C_L = 30\text{ pF}, V_{IH} = V_{CC}, V_{IL} = 0\text{ V}$	2.2	

9. Number of outputs defined as "n". Measured with "n-1" outputs switching from HIGH-to-LOW or LOW-to-HIGH. The remaining output is measured in the LOW state.

10. Number of outputs defined as "n". Measured with "n-1" outputs switching from HIGH-to-LOW or LOW-to-HIGH. The remaining output is measured in the HIGH state.

CAPACITIVE CHARACTERISTICS

Symbol	Parameter	Condition	Typical	Unit
C _{IN}	Input Capacitance	Note 11	6	pF
C _{OUT}	Output Capacitance	Note 11	7	pF
C _{PD}	Power Dissipation Capacitance	Note 11, 10 MHz	20	pF

11. $V_{CC} = 1.8\text{ V}, 2.5\text{ V}$ or 3.3 V ; $V_I = 0\text{ V}$ or V_{CC} .

74VCXH16373

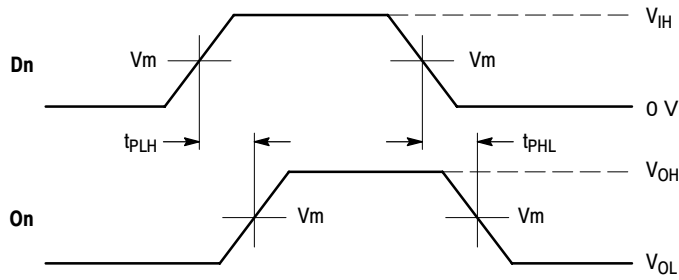

WAVEFORM 1 - PROPAGATION DELAYS
 $t_R = t_F = 2.0 \text{ ns}$, 10% to 90%; $f = 1 \text{ MHz}$; $t_W = 500 \text{ ns}$

Figure 4. AC Waveforms

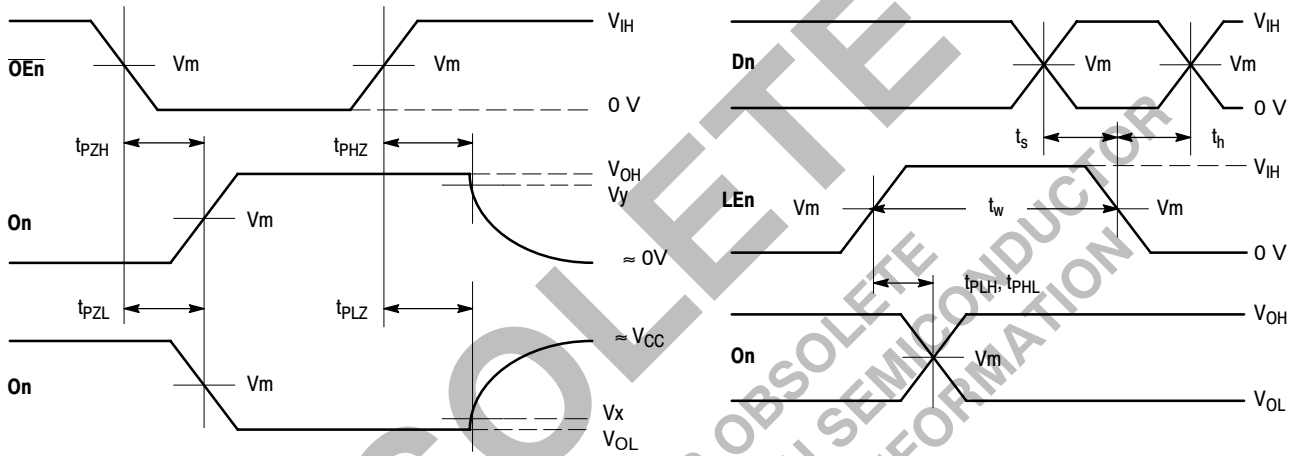

WAVEFORM 2 - OUTPUT ENABLE AND DISABLE TIMES
 $t_R = t_F = 2.0 \text{ ns}$, 10% to 90%; $f = 1 \text{ MHz}$; $t_W = 500 \text{ ns}$

WAVEFORM 3 - LE to On PROPAGATION DELAYS, LE MINIMUM PULSE WIDTH, Dn to LE SETUP AND HOLD TIMES
 $t_R = t_F = 2.0 \text{ ns}$, 10% to 90%; $f = 1 \text{ MHz}$; $t_W = 500 \text{ ns}$ except when noted

Figure 5. AC Waveforms

Table 1. AC WAVEFORMS

Symbol	V_{CC}		
	$3.3 \text{ V} \pm 0.3 \text{ V}$	$2.5 \text{ V} \pm 0.2 \text{ V}$	$1.8 \text{ V} \pm 0.15 \text{ V}$
V_{IH}	2.7 V	V_{CC}	V_{CC}
V_m	1.5 V	$V_{CC}/2$	$V_{CC}/2$
V_x	$V_{OL} + 0.3 \text{ V}$	$V_{OL} + 0.15 \text{ V}$	$V_{OL} + 0.15 \text{ V}$
V_y	$V_{OH} - 0.3 \text{ V}$	$V_{OH} - 0.15 \text{ V}$	$V_{OH} - 0.15 \text{ V}$

74VCXH16373

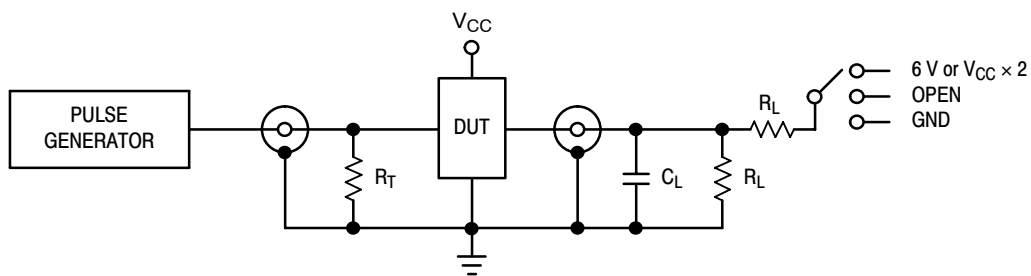

Figure 6. Test Circuit

Table 2. TEST CIRCUIT

TEST	SWITCH
t_{PLH} , t_{PHL}	Open
t_{PZL} , t_{PLZ}	6 V at $V_{CC} = 3.3 \pm 0.3$ V; $V_{CC} \times 2$ at $V_{CC} = 2.5 \pm 0.2$ V; 1.8 ± 0.15 V
t_{PZH} , t_{PHZ}	GND

$C_L = 30$ pF or equivalent (Includes jig and probe capacitance)

$R_L = 500 \Omega$ or equivalent

$R_T = Z_{OUT}$ of pulse generator (typically 50Ω)

OBSOLETE

THIS DEVICE IS OBSOLETE
PLEASE CONTACT YOUR ON SEMICONDUCTOR
REPRESENTATIVE FOR INFORMATION

74VCXH16373

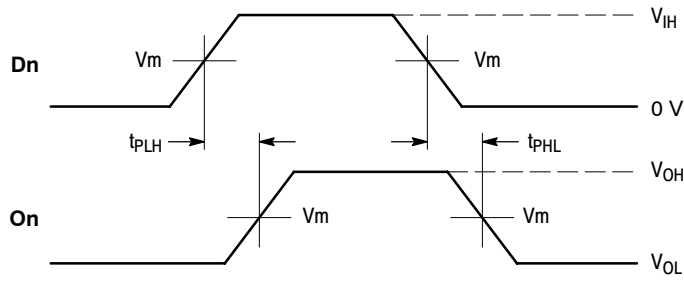

WAVEFORM 4 - PROPAGATION DELAYS
 $t_R = t_F = 2.0 \text{ ns}$, 10% to 90%; $f = 1 \text{ MHz}$; $t_W = 500 \text{ ns}$

Figure 7. AC Waveforms

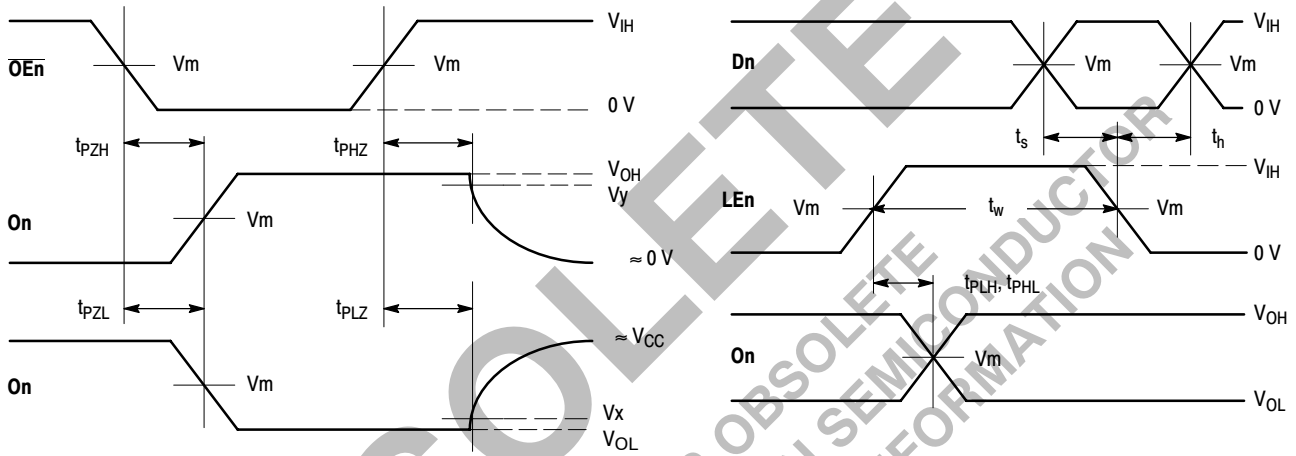

WAVEFORM 5 - OUTPUT ENABLE AND DISABLE TIMES
 $t_R = t_F = 2.0 \text{ ns}$, 10% to 90%; $f = 1 \text{ MHz}$; $t_W = 500 \text{ ns}$

WAVEFORM 6 - LE to On PROPAGATION DELAYS, LE MINIMUM PULSE WIDTH, Dn-to-LE SETUP AND HOLD TIMES
 $t_R = t_F = 2.0 \text{ ns}$, 10% to 90%; $f = 1 \text{ MHz}$; $t_W = 500 \text{ ns}$ except when noted

Figure 8. AC Waveforms

Table 3. AC WAVEFORMS

Symbol	V _{CC}	
	3.3 V ± 0.3 V	2.7 V
V _{IH}	2.7 V	2.7 V
V _m	1.5 V	1.5 V
V _x	V _{OL} + 0.3 V	V _{OL} + 0.3 V
V _y	V _{OH} - 0.3 V	V _{OH} - 0.3 V

74VCXH16373

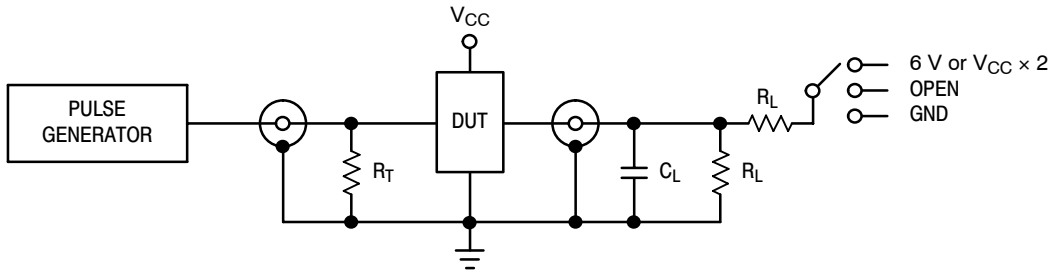

Figure 9. Test Circuit

Table 4. TEST CIRCUIT

TEST	SWITCH
t_{PLH} , t_{PHL}	Open
t_{PZL} , t_{PLZ}	6 V at $V_{CC} = 3.3 \pm 0.3$ V; $V_{CC} \times 2$ at $V_{CC} = 2.5 \pm 0.2$ V; 1.8 ± 0.15 V
t_{PZH} , t_{PHZ}	GND

$C_L = 50$ pF or equivalent (Includes jig and probe capacitance)

$R_L = 500 \Omega$ or equivalent

$R_T = Z_{OUT}$ of pulse generator (typically 50Ω)

OBSOLETE

THIS DEVICE IS OBSOLETE
PLEASE CONTACT YOUR ON SEMICONDUCTOR
REPRESENTATIVE FOR INFORMATION

74VCXH16373

PACKAGE DIMENSIONS

TSSOP
DT SUFFIX
CASE 1201-01
ISSUE A

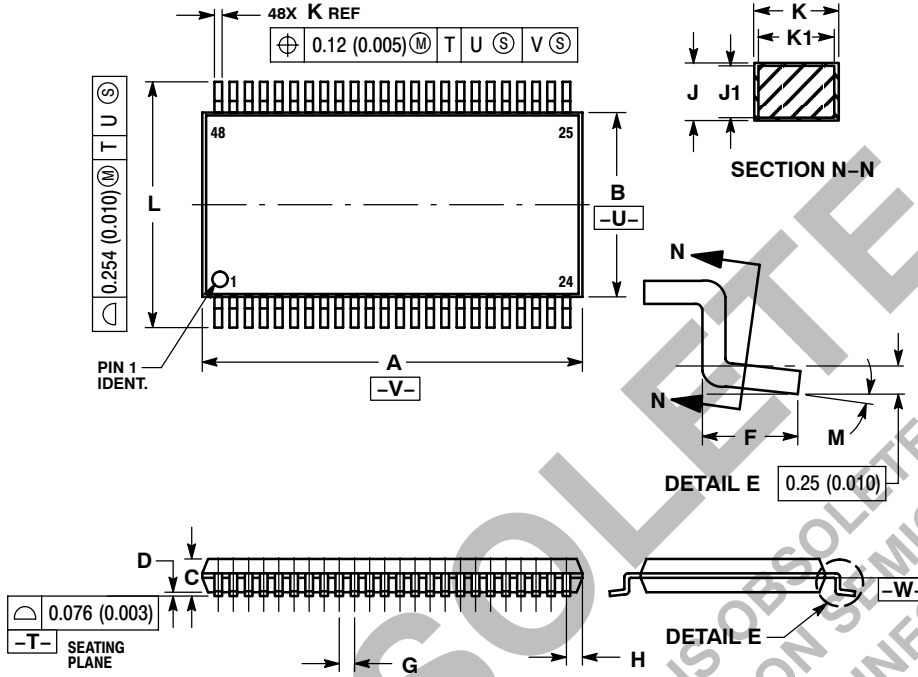

NOTES:

1. DIMENSIONING AND TOLERANCING PER ANSI Y14.5M, 1982.
2. CONTROLLING DIMENSION: MILLIMETER.
3. DIMENSIONS A AND B DO NOT INCLUDE MOLD FLASH, PROTRUSIONS OR GATE BURRS. MOLD FLASH OR GATE BURRS SHALL NOT EXCEED 0.15 (0.006) PER SIDE.
4. DIMENSION K DOES NOT INCLUDE DAMBAR PROTRUSION. ALLOWABLE DAMBAR PROTRUSION SHALL BE 0.08 (0.003) TOTAL IN EXCESS OF THE K DIMENSION AT MAXIMUM MATERIAL CONDITION.
5. TERMINAL NUMBERS ARE SHOWN FOR REFERENCE ONLY.
6. DIMENSIONS A AND B ARE TO BE DETERMINED AT DATUM PLANE -W-.

DIM	MILLIMETERS		INCHES	
	MIN	MAX	MIN	MAX
A	12.40	12.60	0.488	0.496
B	6.00	6.20	0.236	0.244
C	---	1.10	---	0.043
D	0.05	0.15	0.002	0.006
F	0.50	0.75	0.020	0.030
G	0.50 BSC		0.0197 BSC	
H	0.37	---	0.015	---
J	0.09	0.20	0.004	0.008
J1	0.09	0.16	0.004	0.006
K	0.17	0.27	0.007	0.011
K1	0.17	0.23	0.007	0.009
L	7.95	8.25	0.313	0.325
M	0°	8°	0°	8°

ON Semiconductor and are registered trademarks of Semiconductor Components Industries, LLC (SCILLC). SCILLC reserves the right to make changes without further notice to any products herein. SCILLC makes no warranty, representation or guarantee regarding the suitability of its products for any particular purpose, nor does SCILLC assume any liability arising out of the application or use of any product or circuit, and specifically disclaims any and all liability, including without limitation special, consequential or incidental damages. "Typical" parameters which may be provided in SCILLC data sheets and/or specifications can and do vary in different applications and actual performance may vary over time. All operating parameters, including "Typicals" must be validated for each customer application by customer's technical experts. SCILLC does not convey any license under its patent rights nor the rights of others. SCILLC products are not designed, intended, or authorized for use as components in systems intended for surgical implant into the body, or other applications intended to support or sustain life, or for any other application in which the failure of the SCILLC product could create a situation where personal injury or death may occur. Should Buyer purchase or use SCILLC products for any such unintended or unauthorized application, Buyer shall indemnify and hold SCILLC and its officers, employees, subsidiaries, affiliates, and distributors harmless against all claims, costs, damages, and expenses, and reasonable attorney fees arising out of, directly or indirectly, any claim of personal injury or death associated with such unintended or unauthorized use, even if such claim alleges that SCILLC was negligent regarding the design or manufacture of the part. SCILLC is an Equal Opportunity/Affirmative Action Employer. This literature is subject to all applicable copyright laws and is not for resale in any manner.

PUBLICATION ORDERING INFORMATION

LITERATURE FULFILLMENT:
Literature Distribution Center for ON Semiconductor
P.O. Box 5163, Denver, Colorado 80217 USA
Phone: 303-675-2175 or 800-344-3860 Toll Free USA/Canada
Fax: 303-675-2176 or 800-344-3867 Toll Free USA/Canada
Email: orderlit@onsemi.com

N. American Technical Support: 800-282-9855 Toll Free
USA/Canada
Europe, Middle East and Africa Technical Support:
Phone: 421 33 790 2910
Japan Customer Focus Center
Phone: 81-3-5773-3850

ON Semiconductor Website: www.onsemi.com
Order Literature: <http://www.onsemi.com/orderlit>

For additional information, please contact your local Sales Representative