

CKT	A	B	C
2	5.0	10.1	11.7
3	10.0	15.1	16.7
4	15.0	20.1	21.7
5	20.0	25.1	26.7
6	25.0	30.1	31.7
7	30.0	35.1	36.7
8	35.0	40.1	41.7

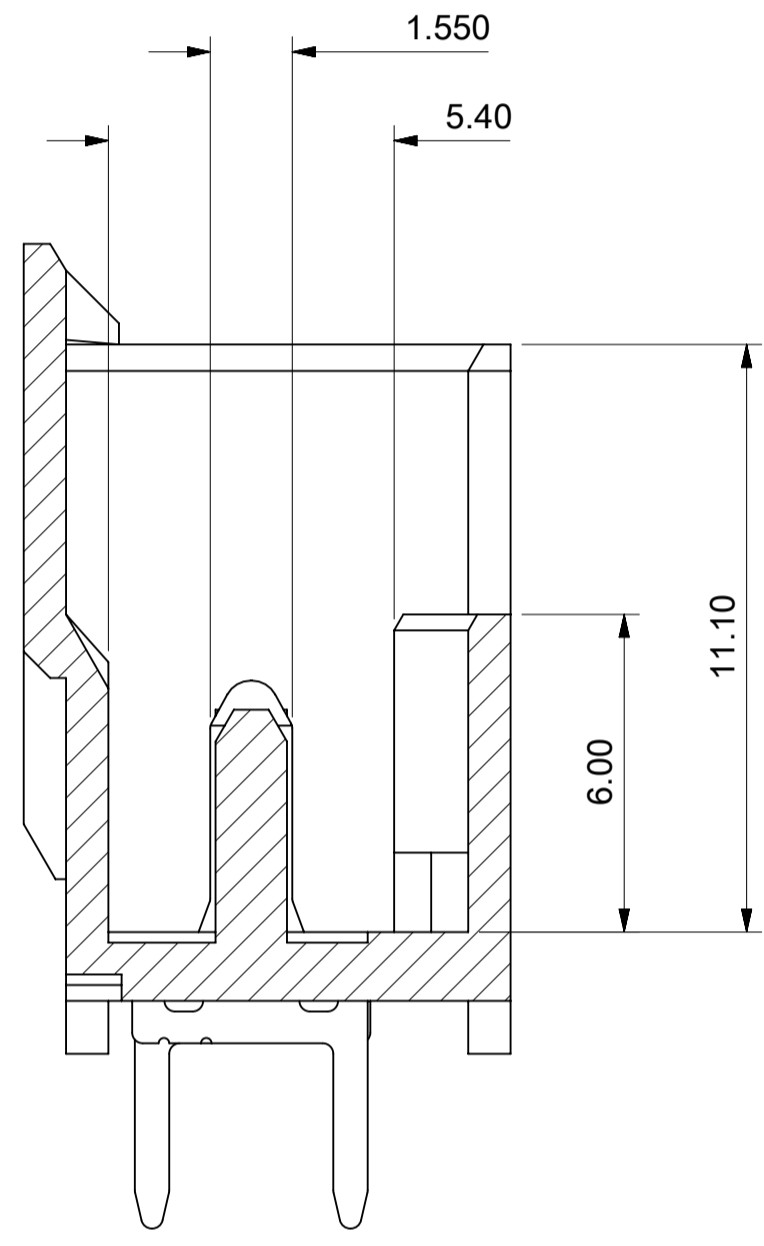

SECTION Z-Z

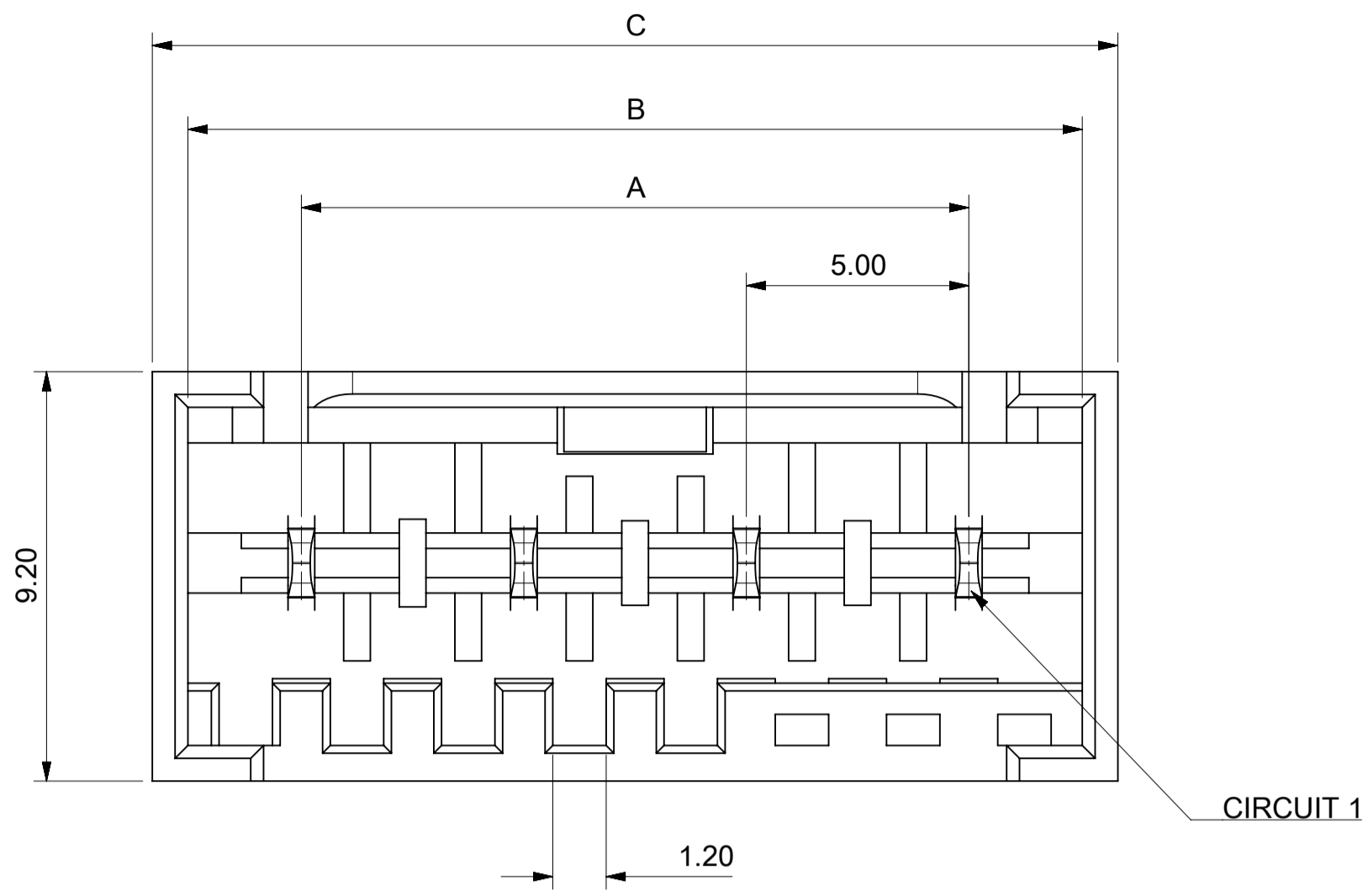
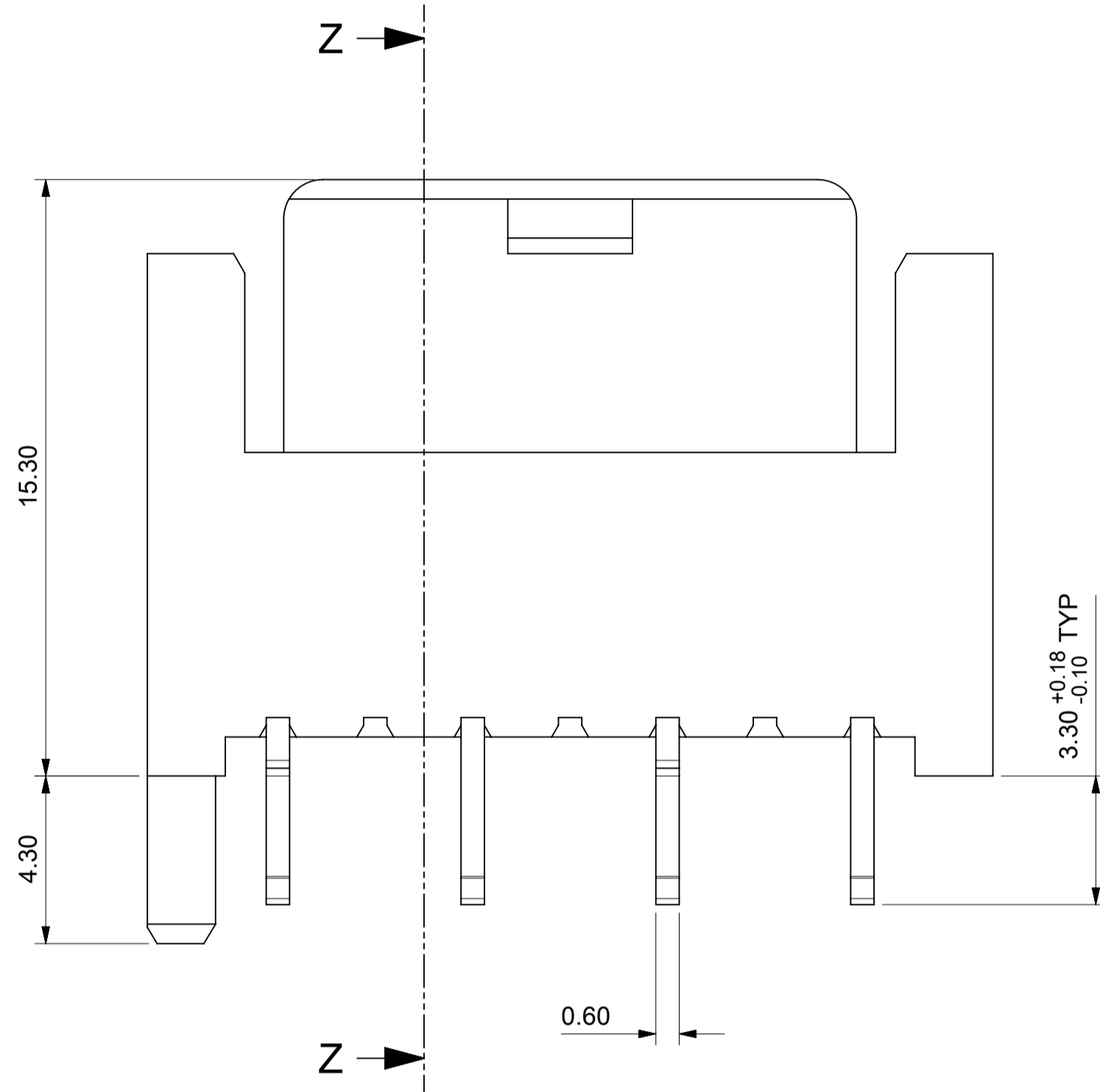

ASSEMBLY WITHOUT LATCH
(OPTIONAL)

NOTES:

- MATERIAL: HOUSING - PA66 25% G/F, UL94 V-0
PA66 25% G/F, UL94 V-0
COLOUR: NATURAL
TERMINAL - BRASS
PLATING - 3-7µm Sn over 1.27µm Min Ni
- PARTS PACKED AS PER PK-93070-001
- PRODUCT SPECIFICATION: PS-99039-0040
- RECOMMENDED PCB THICKNESS: 1.5+/-0.14mm

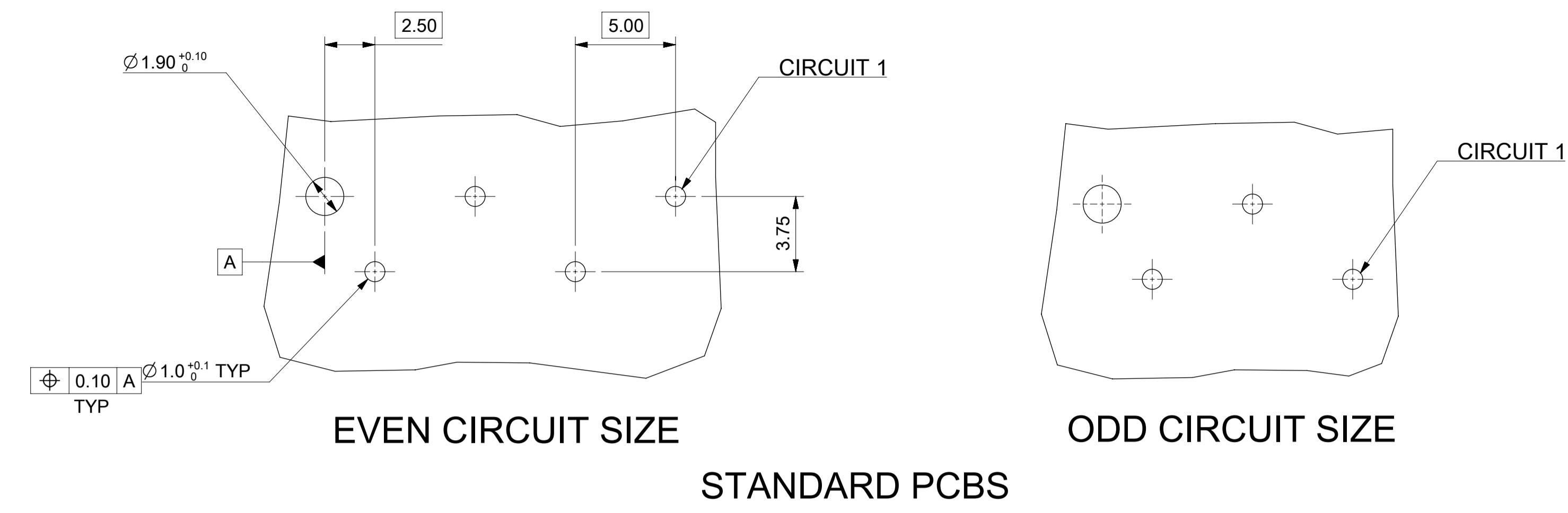

EVEN CIRCUIT SIZE

ODD CIRCUIT SIZE

STANDARD PCB LAYOUT

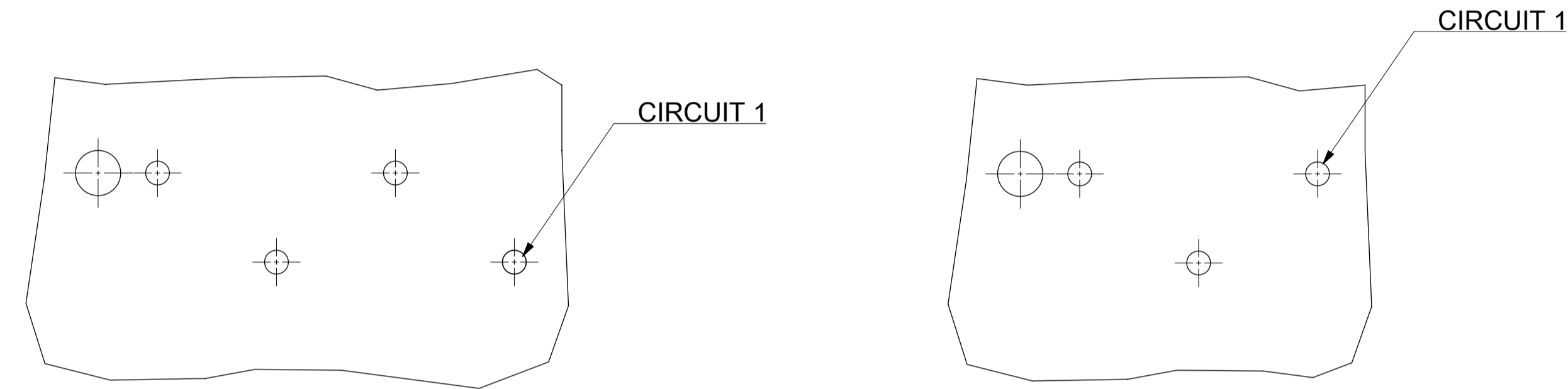

EVEN CIRCUIT SIZE

ODD CIRCUIT SIZE

RECOMMENDED OPPOSITE PCB LAYOUT

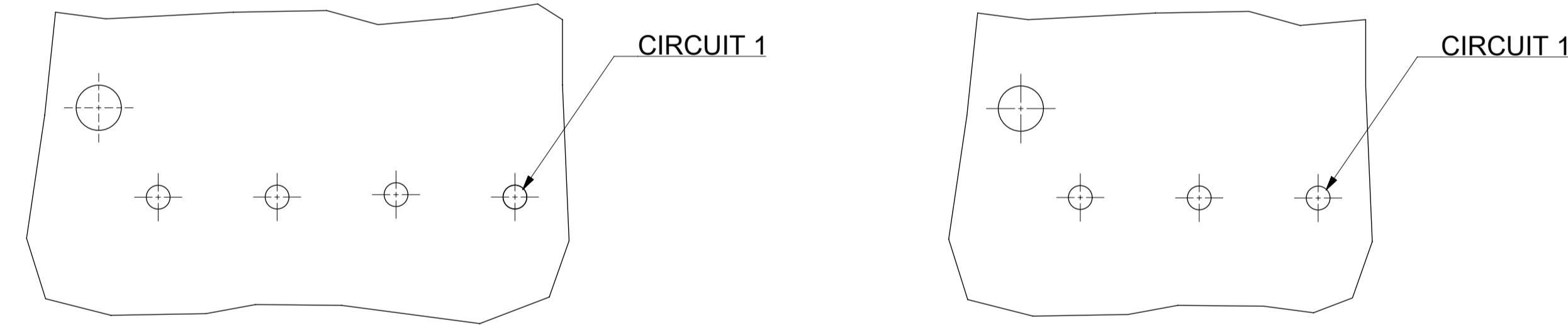



EVEN CIRCUIT SIZE

ODD CIRCUIT SIZE

OPTION 'C' PCB LAYOUT

THIS DRAWING CONTAINS INFORMATION THAT IS PROPRIETARY TO MOLEX ELECTRONIC TECHNOLOGIES, LLC AND SHOULD NOT BE USED WITHOUT WRITTEN PERMISSION

DIMENSION UNITS	SCALE	CURRENT REV DESC:		 RAST 2.5 APPLI-MATE VERTICAL MALE HEADER		
mm	5:1					
GENERAL TOLERANCES (UNLESS SPECIFIED)		EC NO: 736758		DOCUMENT NUMBER		
ANGULAR TOL	± 2.0°	DRWN: MBN02	2022/06/22	930710001		
4 PLACES	±	CHK'D: RAHULH3	2023/02/06	DOC TYPE	DOC PART	REVISION
3 PLACES	± 0.05	APPR: MRAMAKRISHNA	2023/02/06	PSD	000	A1
2 PLACES	± 0.1	INITIAL REVISION:		PRODUCT CUSTOMER DRAWING		
1 PLACE	± 0.2	DRWN: CRAODOREMS	2017/10/03	MATERIAL NUMBER		
0 PLACES	±	APPR: BRUTTLE	2018/03/20	CUSTOMER		
DRAFT WHERE APPLICABLE MUST REMAIN WITHIN DIMENSIONS		THIRD ANGLE PROJECTION	DRAWING	SERIES	SHEET NUMBER	
			A1-SIZE	93071	1 OF 4	
				SEE SHEETS 2-3	GENERAL MARKET	

DOCUMENT STATUS	P1	RELEASE DATE	2023/02/06	11:17:30
-----------------	----	--------------	------------	----------

2 CIRCUIT

MOLEX PART NO.	HOUSING PART NO.	BLOCKED POSITION KEYS	TERMINAL VOID POSITION	CONFIGURATION	LATCH	CIRCUIT 1 LOCATION	HOUSING COLOUR	
93071-0001	91698-0001	NONE	CCT 2		YES	STANDARD	NATURAL	
93071-0002	91698-0006	d	CCT 2		YES	STANDARD		
93071-0003	91698-0004	b	CCT 2		YES	STANDARD		
93071-0004	91698-0007	b d	CCT 2		YES	STANDARD		
93071-0005	91698-0008	a c	CCT 2		YES	STANDARD		
93071-0006	91698-0002	a d	CCT 2		YES	STANDARD		
93071-0007	91698-0003	a	CCT 2		YES	STANDARD		
93071-0008	91698-0009	a b	CCT 2		YES	STANDARD		
93071-0009	91698-0010	b c	CCT 2		YES	STANDARD		
93071-0010	91698-0011	c d	CCT 2		YES	STANDARD		
93071-0011	91698-0012	a b c	CCT 2		YES	STANDARD		
93071-0012	91698-0016	a c d	CCT 2		YES	STANDARD		
93071-0013	91698-0014	b c d	CCT 2		YES	STANDARD		
93071-0014	91698-0015	ALL	CCT 2		YES	STANDARD		
93071-0015	91698-0017	a	CCT 2		YES	STANDARD		RED
93071-0016	91698-0021	a	CCT 2		YES	STANDARD		BLACK
93071-0017	91698-0005	c	CCT 2		YES	STANDARD	NATURAL	

3 CIRCUIT

MOLEX PART NO.	HOUSING PART NO.	BLOCKED POSITION KEYS	TERMINAL VOID POSITION	CONFIGURATION	LATCH	CIRCUIT 1 LOCATION	HOUSING COLOUR
93071-1001	91698-1001	NONE	CCT 2, 4		YES	STANDARD	NATURAL
93071-1002	91698-1010	a c d e	CCT 2, 4		YES	STANDARD	
93071-1003	91698-1011	b c d e	CCT 2, 4		YES	STANDARD	
93071-1004	91698-1012	c	CCT 2, 4		YES	STANDARD	
93071-1005	91698-1013	d e f	CCT 2, 4		YES	STANDARD	
93071-1006	91698-1003	a c e	CCT 2, 4		YES	STANDARD	
93071-1007	91698-1015	a e	CCT 2, 4		YES	STANDARD	
93071-1008	91698-1002	ALL	CCT 2, 4		YES	STANDARD	
93071-1009	91698-1001	NONE	CCT 2, 4		YES	OPPOSITE	
93071-1010	91698-1001	NONE	CCT 2, 4		YES	OPTION C	
93071-1011	91698-1025	e f	CCT 2, 4		YES	STANDARD	
93071-1012	91698-1026	a b	CCT 2, 4		YES	STANDARD	
93071-1013	91698-1027	NONE	CCT 2, 4		YES	OPPOSITE	
93071-1014	91698-1030	a d e f	CCT 2, 4		YES	STANDARD	NATURAL

(A1)

NOTES:

- 1. + DENOTES TERMINAL VOIDED POSITION
- ⊕ DENOTES TERMINAL LOADED POSITION

THIS DRAWING CONTAINS INFORMATION THAT IS PROPRIETARY TO MOLEX ELECTRONIC TECHNOLOGIES, LLC AND SHOULD NOT BE USED WITHOUT WRITTEN PERMISSION									
DIMENSION UNITS mm		SCALE 1:1		CURRENT REV DESC:				molex	
GENERAL TOLERANCES (UNLESS SPECIFIED)				EC NO: 736758					
ANGULAR TOL ± 2.0°		4 PLACES ±		DRWN: MBN02 2022/06/22		RAST 2.5 APPLI-MATE VERTICAL MALE HEADER		PRODUCT CUSTOMER DRAWING	
3 PLACES ± 0.05		2 PLACES ± 0.1		CHK'D: RAHULH3 2023/02/06		APPR: MRAMAKRISHNA 2023/02/06		DOCUMENT NUMBER	
1 PLACE ± 0.2		0 PLACES ±		INITIAL REVISION:		DRWN: CRAODOREMS 2017/10/03		DOC PART	
DRAFT WHERE APPLICABLE MUST REMAIN WITHIN DIMENSIONS		THIRD ANGLE PROJECTION		DRAWING		SERIES		REVISION	
				A1-SIZE		93071		PSD 000 A1	
				SEE SHEETS 2-3		GENERAL MARKET		SHEET NUMBER	
								2 OF 4	

4 CIRCUIT

MOLEX PART NO.	HOUSING PART NO.	BLOCKED POSITION KEYS	TERMINAL VOID POSITION	CONFIGURATION	LATCH	CIRCUIT 1 LOCATION	HOUSING COLOUR
93071-2001	91698-2001	NONE	CCT 2, 4, 6		YES	STANDARD	NATURAL
93071-2002	91698-2011	b c d e f h	CCT 2, 4, 6		YES	STANDARD	
93071-2003	91698-2012	b c d e f g	CCT 2, 4, 6		YES	STANDARD	
93071-2004	91698-2013	b c d f	CCT 2, 4, 6		YES	STANDARD	
93071-2005	91698-2017	a b c d e f	CCT 2, 4, 6		YES	STANDARD	
93071-2006	91698-2018	d e f g h	CCT 2, 4, 6		YES	STANDARD	
93071-2007	91698-2019	b d e	CCT 2, 4, 6		YES	STANDARD	
93071-2008	91698-2020	c e	CCT 2, 4, 6		YES	STANDARD	

6 CIRCUIT

MOLEX PART NO.	HOUSING PART NO.	BLOCKED POSITION KEYS	TERMINAL VOID POSITION	CONFIGURATION	LATCH	CIRCUIT 1 LOCATION	HOUSING COLOUR
93071-4001	91698-4001	NONE	CCT 2, 4, 6, 8, 10		YES	STANDARD	NATURAL
93071-4002	91698-4002	a d	CCT 2, 4, 6, 8, 10		YES	STANDARD	NATURAL

7 CIRCUIT

MOLEX PART NO.	HOUSING PART NO.	BLOCKED POSITION KEYS	TERMINAL VOID POSITION	CONFIGURATION	LATCH	CIRCUIT 1 LOCATION	HOUSING COLOUR
93071-5001	91698-5001	NONE	CCT 2, 4, 6, 8, 10, 12		YES	STANDARD	NATURAL
93071-5002	91698-5003	c d e f g h i j k l m n	CCT 2, 4, 6, 8, 10, 12		YES	STANDARD	NATURAL
93071-5003	91698-5004	a b c d e f g h i j k l m n	CCT 2, 4, 6, 8, 10, 12		YES	STANDARD	NATURAL

5 CIRCUIT

MOLEX PART NO.	HOUSING PART NO.	BLOCKED POSITION KEYS	TERMINAL VOID POSITION	CONFIGURATION	LATCH	CIRCUIT 1 LOCATION	HOUSING COLOUR
93071-3001	91698-3001	NONE	CCT 2, 4, 6, 8		YES	STANDARD	NATURAL
93071-3002	91698-3005	b c d g h j	CCT 2, 4, 6, 8		YES	STANDARD	NATURAL
93071-3003	91698-3007	a b c d f g h i j	CCT 2, 4, 6, 8		YES	STANDARD	NATURAL
93071-3004	91698-3008	b c d g h i j	CCT 2, 4, 6, 8		YES	STANDARD	RED
93071-3005	91698-3009	c e j	CCT 2, 4, 6, 8		YES	STANDARD	NATURAL

8 CIRCUIT

MOLEX PART NO.	HOUSING PART NO.	BLOCKED POSITION KEYS	TERMINAL VOID POSITION	CONFIGURATION	LATCH	CIRCUIT 1 LOCATION	HOUSING COLOUR
93071-6001	91698-6001	NONE	CCT 2, 4, 6, 8, 10, 12, 14		YES	STANDARD	NATURAL

- NOTES:
- 1. + DENOTES TERMINAL VOIDED POSITION
 - ⊕ DENOTES TERMINAL LOADED POSITION

THIS DRAWING CONTAINS INFORMATION THAT IS PROPRIETARY TO MOLEX ELECTRONIC TECHNOLOGIES, LLC AND SHOULD NOT BE USED WITHOUT WRITTEN PERMISSION									
DIMENSION UNITS	SCALE	CURRENT REV DESC:					molex		
mm	1:1								
GENERAL TOLERANCES (UNLESS SPECIFIED)		EC NO: 736758					RAST 2.5 APPLI-MATE VERTICAL MALE HEADER		
ANGULAR TOL	± 2.0°	DRWN: MBN02 2022/06/22					PRODUCT CUSTOMER DRAWING		
4 PLACES	±	CHK'D: RAHULH3 2023/02/06					DOCUMENT NUMBER		
3 PLACES	± 0.05	APPR: MRAMAKRISHNA 2023/02/06					930710001		
2 PLACES	± 0.1	INITIAL REVISION:					DOC TYPE DOC PART REVISION		
1 PLACE	± 0.2	DRWN: CRAODOREMS 2017/10/03					PSD 000 A1		
0 PLACES	±	APPR: BRUTTLE 2018/03/20					SHEET NUMBER		
DRAFT WHERE APPLICABLE MUST REMAIN WITHIN DIMENSIONS		THIRD ANGLE PROJECTION	DRAWING	SERIES	MATERIAL NUMBER	CUSTOMER	SHEET NUMBER		
			A1-SIZE	93071	SEE SHEETS 2-3	GENERAL MARKET	3 OF 4		

9 CIRCUIT							
MOLEX PART NO.	HOUSING PART NO.	BLOCKED POSITION KEYS	TERMINAL VOID POSITION	CONFIGURATION	LATCH	CIRCUIT 1 LOCATION	HOUSING COLOUR
93071-7001	91698-7001	NONE	CCT 2, 4, 6, 8, 10, 12, 14, 16		YES	STANDARD	NATURAL

A1

10 CIRCUIT							
MOLEX PART NO.	HOUSING PART NO.	BLOCKED POSITION KEYS	TERMINAL VOID POSITION	CONFIGURATION	LATCH	CIRCUIT 1 LOCATION	HOUSING COLOUR
93071-8001	91698-8001	NONE	CCT 2, 4, 6, 8, 10, 12, 14, 16, 18		YES	STANDARD	NATURAL

A1

THIS DRAWING CONTAINS INFORMATION THAT IS PROPRIETARY TO MOLEX ELECTRONIC TECHNOLOGIES, LLC AND SHOULD NOT BE USED WITHOUT WRITTEN PERMISSION										
DIMENSION UNITS	SCALE	CURRENT REV DESC:								
mm	1:1									
GENERAL TOLERANCES (UNLESS SPECIFIED)		EC NO: 736758 DRWN: MBN02 2022/06/22 CHK'D: RAHULH3 2023/02/06 APPR: MRAMAKRISHNA 2023/02/06 INITIAL REVISION: DRWN: CRAODOREMS 2017/10/03 APPR: BRUTTLE 2018/03/20				RAST 2.5 APPLI-MATE VERTICAL MALE HEADER				
ANGULAR TOL	± 2.0°					PRODUCT CUSTOMER DRAWING				
4 PLACES	±					DOCUMENT NUMBER		DOC TYPE	DOC PART	REVISION
3 PLACES	± 0.05					930710001		PSD	000	A1
2 PLACES	± 0.1					MATERIAL NUMBER		CUSTOMER		SHEET NUMBER
1 PLACE	± 0.2							GENERAL MARKET		4 OF 4
0 PLACES	±									
DRAFT WHERE APPLICABLE MUST REMAIN WITHIN DIMENSIONS		THIRD ANGLE PROJECTION	DRAWING	SERIES	CUSTOMER		SHEET NUMBER			
			A1-SIZE	93071	GENERAL MARKET		4 OF 4			

DOCUMENT STATUS	P1	RELEASE DATE	2023/02/06 11:17:30
-----------------	----	--------------	---------------------