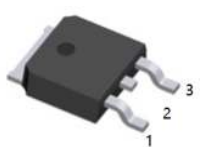
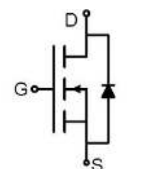

UMW 30N06

<p>General Description</p> <p>The 30N06 uses advanced trench technology and design to provide excellent $R_{DS(ON)}$ with low gate charge. It can be used in a wide variety of applications.</p> <p>Features</p> <ul style="list-style-type: none"> ● $V_{DS} = 60V, I_D = 30A$ ● $R_{DS(ON)}, 23m\Omega (Typ) @ V_{GS} = 10V$ ● $R_{DS(ON)}, 29m\Omega (Typ) @ V_{GS} = 4.5V$ ● Advanced Trench Technology ● Excellent $R_{DS(ON)}$ and Low Gate Charge ● Lead free product is acquired <p>Application</p> <ul style="list-style-type: none"> ● Load Switch ● PWM Application ● Power management 	 <p>1.Date 2.Drain 3.Source TO-252(DPAK) top view</p>  <p>Schematic Diagram</p>
--	---

Package Marking and Ordering Information

Device Marking	Device	Device Package	Reel Size	Tape width	Quantity
UMW 30N06	UMW 30N06	TO-252	330mm	12mm	2500

Absolute Maximum Ratings(TA=25°C unless otherwise noted)

Parameter		Symbol	Value	Unit
Drain-Source Voltage		V_{DS}	60	V
Gate-Source Voltage		V_{GS}	±20	V
Drain Current-Continuous ^{Note3}	TC=25°C	I_D	30	A
	TC=100°C		20	A
Drain Current-Pulsed ^{Note1}		I_{DM}	120	A
Avalanche Energy ^{Note4}		E_{AS}	72	mJ
Maximum Power Dissipation	TC=25°C	P_D	55	W
Storage Temperature Range		T_{STG}	-55 to +150	°C
Operating Junction Temperature Range		T_J	-55 to +150	°C

Thermal Resistance

Parameter	Symbol	Min.	Typ.	Max	Unit
Thermal Resistance, Junction-to-Case	$R_{\theta JC}$	-	-	2.7	°C/W

60V N-Channel Enhancement Mode Power MOSFET
Electrical Characteristics(T_J=25°C unless otherwise noted)

OFF CHARACTERISTICS						
Parameter	Symbol	Conditions	Min.	Typ.	Max.	Unit
Drain-Source Breakdown Voltage	BV _{DSS}	V _{GS} =0V, I _{DS} =250uA	60	-	-	V
Zero Gate Voltage Drain Current	I _{DSS}	V _{DS} =60V, V _{GS} =0V	-	-	1	uA
Gate-Body Leakage	I _{GSS}	V _{GS} =±20V, V _{DS} =0V	-	-	±100	nA

ON CHARACTERISTICS						
Parameter	Symbol	Conditions	Min.	Typ.	Max.	Unit
Gate Threshold Voltage	V _{GS(TH)}	V _{DS} =V _{GS} , I _{DS} =250uA	1.0	1.6	2.5	V
Drain-Source On-State Resistance	R _{DS(ON)}	V _{GS} =10V, I _{DS} =15A	-	23	29	mΩ
		V _{GS} =4.5V, I _{DS} =10A	-	29	40	mΩ

DYNAMIC CHARACTERISTICS						
Parameter	Symbol	Conditions	Min.	Typ.	Max.	Unit
Input Capacitance	C _{ISS}	V _{DS} =25V, V _{GS} = 0V, f=1MHz	-	1562	-	pF
Output Capacitance	C _{OSS}		-	75.4	-	
Reverse Transfer Capacitance	C _{rss}		-	66.8	-	

SWITCHING CHARACTERISTICS						
Parameter	Symbol	Conditions	Min.	Typ.	Max.	Unit
Turn-On Delay Time	T _{d(on)}	V _{GS} =10V, V _{DS} =30V, R _{GEN} =1.8Ω I _D =15A	-	7.5	-	ns
Rise Time	t _r		-	21	-	
Turn-Off Delay Time	T _{d(off)}		-	16	-	
Fall Time	t _f		-	23.5	-	
Total Gate Charge at 10V	Q _g	V _{DS} =30V, I _{DS} =15A, V _{GS} =10V	-	25	-	nC
Gate to Source Gate Charge	Q _{gs}		-	4.5	-	
Gate to Drain"Miller"Charge	Q _{gd}		-	6.5	-	

DRAIN-SOURCE DIODE CHARACTERISTICS AND MAXIMUM RATINGS						
Parameter	Symbol	Conditions	Min.	Typ.	Max.	Unit
Drain-Source Diode Forward Voltage	V _{SD}	V _{GS} =0V, I _{DS} =15A	-	-	1.2	V
Reverse Recovery Time	t _{rr}	T _J =25°C, I _F =15A di/dt=100A/us	-	29	-	nS
Reverse Recovery Charge	Q _{rr}		-	45	-	nC

Notes:

- 1: Repetitive rating, pulse width limited by maximum junction temperature.
- 2: Surface mounted on FR4 Board, t_s≤10sec.
- 3: Pulse width ≤ 300μs, duty cycle ≤ 2%.
- 4: EAS condition: L=0.5mH, V_{DD}=30V, V_G=10V, V_{GATE}=60V, Start T_J=25°C.

60V N-Channel Enhancement Mode Power MOSFET

Typical Performance Characteristics

Figure 1: Output Characteristics

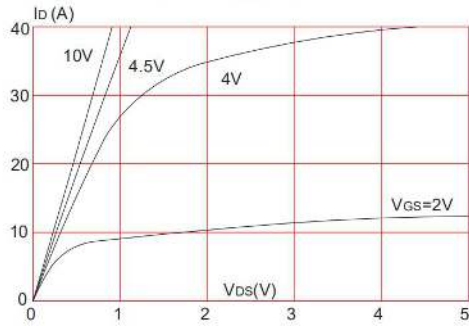

Figure 2: Typical Transfer Characteristics

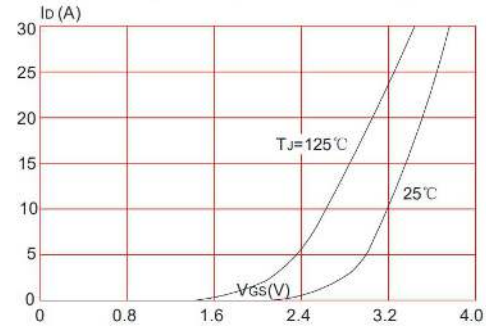

Figure 3: On-resistance vs. Drain Current

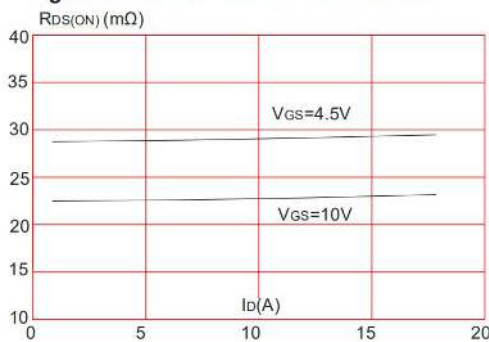

Figure 4: Body Diode Characteristics

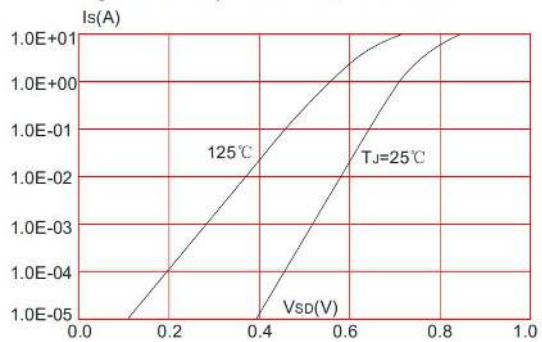

Figure 5: Gate Charge Characteristics

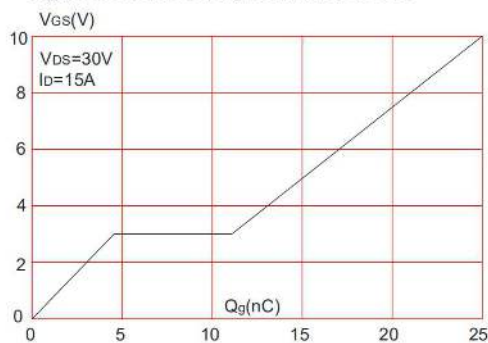
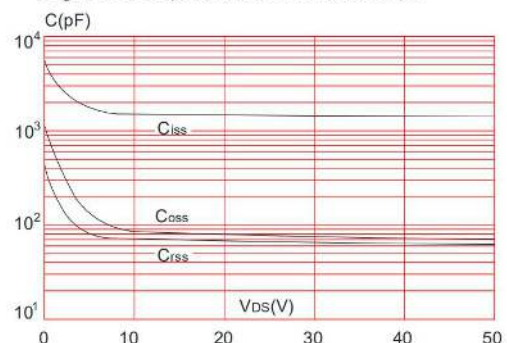

Figure 6: Capacitance Characteristics



60V N-Channel Enhancement Mode Power MOSFET

Figure 7: Normalized Breakdown Voltage vs. Junction Temperature

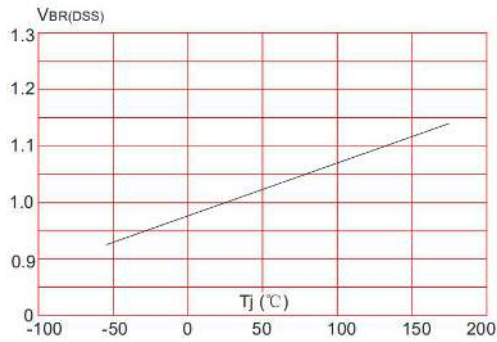

Figure 8: Normalized on Resistance vs. Junction Temperature

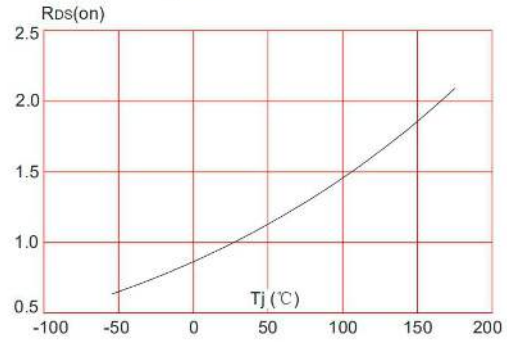

Figure 9: Maximum Safe Operating Area

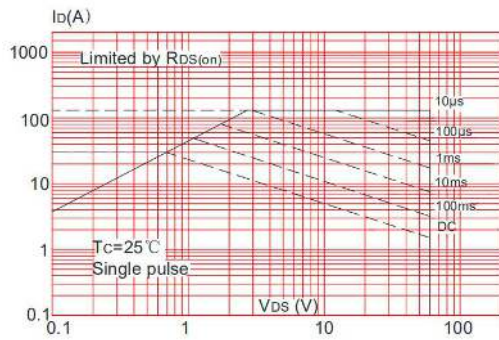

Figure 10: Maximum Continuous Drain Current vs. Case Temperature

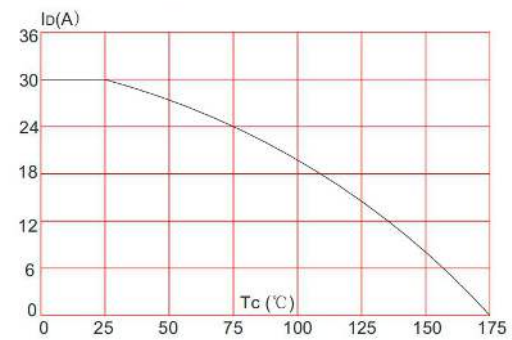
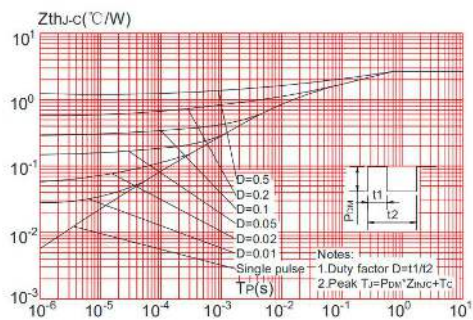

Figure 11: Maximum Effective Transient Thermal Impedance, Junction-to-Case



60V N-Channel Enhancement Mode Power MOSFET

Test Circuit

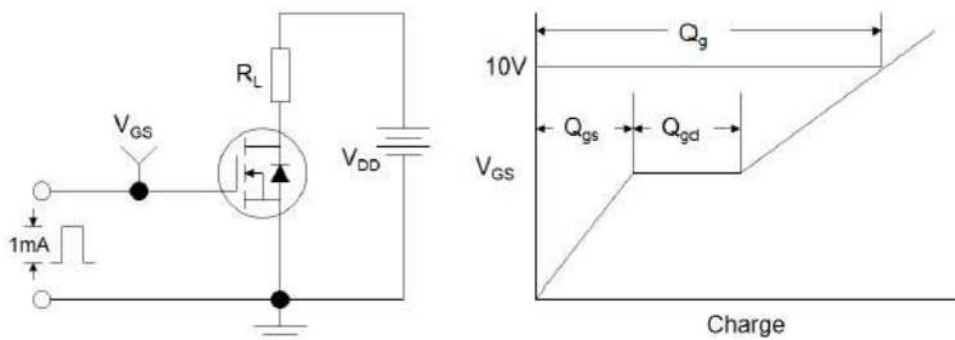

Figure1:Gate Charge Test Circuit & Waveform

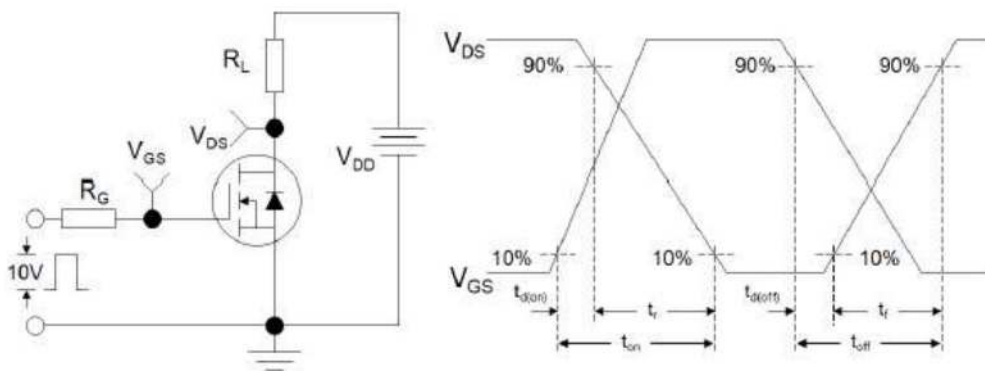

Figure 2: Resistive Switching Test Circuit & Waveforms

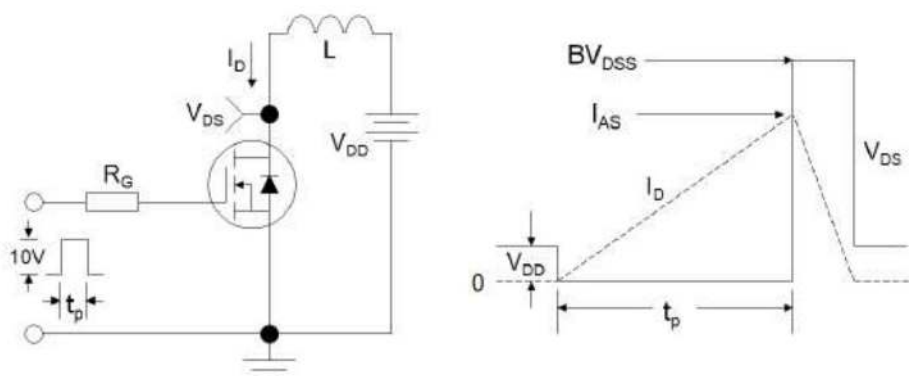
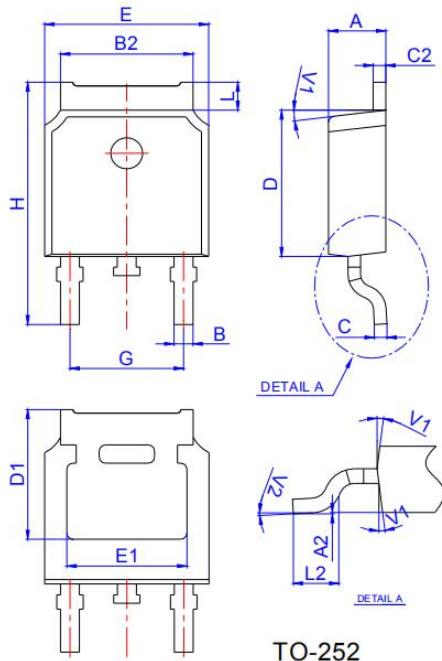

Figure 3:Unclamped Inductive Switching Test Circuit & Waveforms

60V N-Channel Enhancement Mode Power MOSFET

Package Mechanical Data



Ref.	Dimensions					
	Millimeters			Inches		
	Min.	Typ.	Max.	Min.	Typ.	Max.
A	2.10		2.50	0.083		0.098
A2	0		0.10	0		0.004
B	0.66		0.86	0.026		0.034
B2	5.18		5.48	0.202		0.216
C	0.40		0.60	0.016		0.024
C2	0.44		0.58	0.017		0.023
D	5.90		6.30	0.232		0.248
D1	5.30REF			0.209REF		
E	6.40		6.80	0.252		0.268
E1	4.63			0.182		
G	4.47		4.67	0.176		0.184
H	9.50		10.70	0.374		0.421
L	1.09		1.21	0.043		0.048
L2	1.35		1.65	0.053		0.065
V1		7°			7°	
V2	0°		6°	0°		6°

TO-252

Reel Specification-TO-252

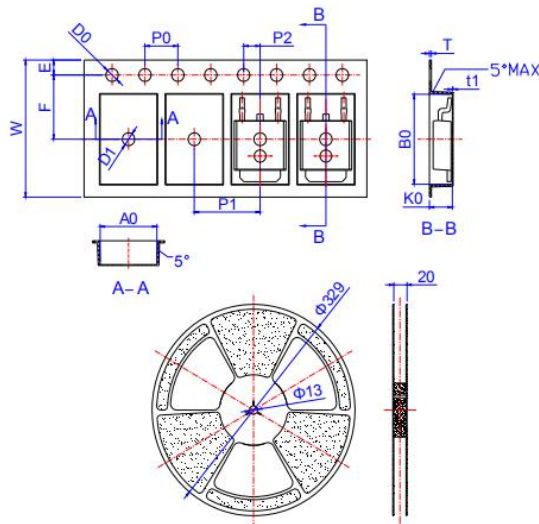

Ref.	Dimensions					
	Millimeters			Inches		
	Min.	Typ.	Max.	Min.	Typ.	Max.
W	15.90	16.00	16.10	0.626	0.630	0.634
E	1.65	1.75	1.85	0.065	0.069	0.073
F	7.40	7.50	7.60	0.291	0.295	0.299
D0	1.40	1.50	1.60	0.055	0.059	0.063
D1	1.40	1.50	1.60	0.055	0.059	0.063
P0	3.90	4.00	4.10	0.154	0.157	0.161
P1	7.90	8.00	8.10	0.311	0.315	0.319
P2	1.90	2.00	2.10	0.075	0.079	0.083
A0	6.85	6.90	7.00	0.270	0.271	0.276
B0	10.45	10.50	10.60	0.411	0.413	0.417
K0	2.68	2.78	2.88	0.105	0.109	0.113
T	0.24		0.27	0.009		0.011
t1	0.10			0.004		
10P0	39.80	40.00	40.20	1.567	1.575	1.583