

THIS COPY IS PROVIDED ON A RESTRICTED BASIS AND IS NOT TO BE USED IN ANY WAY DETRIMENTAL TO THE INTERESTS OF PANDUIT CORP.

Material	High Conductivity Seamless Copper Tube
Plating	Electro-Tin
Wire Size	6 STR/FLEX
Wire Type	Stranded Copper: Class B & C, Compact, Class G, H, I, K, M, Locomotive
Wire Strip Length	9/16 in.
Stud Size	3/8 in.
UL Listed Wire Connector	Yes, for applications up to 35kv. Consult cable manufacturer for voltage stress relief instructions with applications greater than 2000 volts.
UL Temperature Rating	90° C
C.S.A Certified Wire Connector	Yes
Panduit Color Code on Barrel	BLUE
Panduit Die Index No. on Barrel	P24
Alternate Industry Die Index No. () on Barrel	(7)

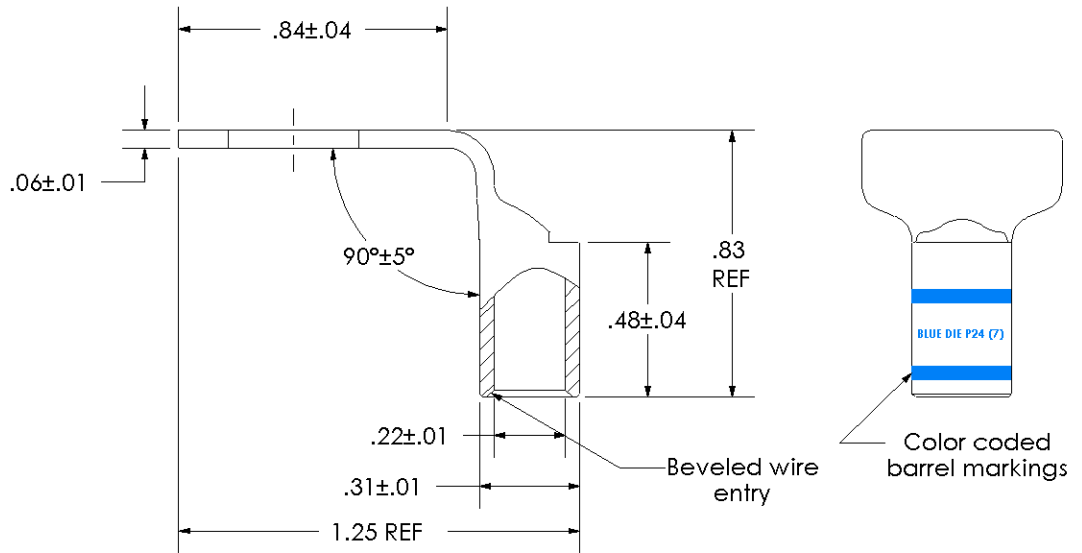
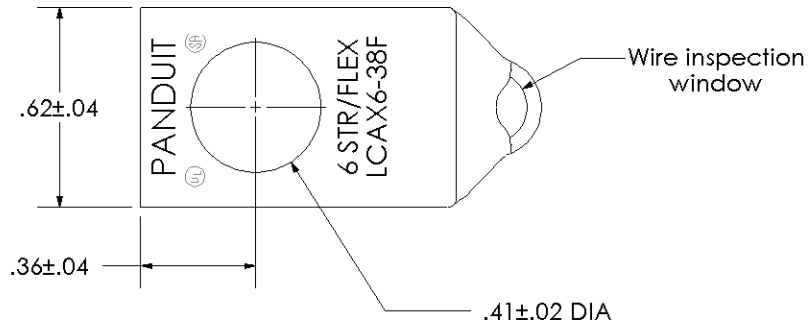

PANDUIT CORP. TINLEY PARK, ILLINOIS

LCAX6-38F-L
Copper Lug - One-Hole, Standard Flex Barrel, 90° Angle Tongue

00	6/03	CJW	SAC
REV	DATE	BY	CHK

RELEASED
DESCRIPTION

10850
ECN

SCALE
N/A

DRAWING NO / CAD FILE

LCAX6-38F-CUST