

Copying of this document and giving it to others and the use or communication of the contents thereof, are forbidden without express authority. Offenders are liable to the payment of damages. All rights are reserved in the event of the grant of a patent or the registration of the utility model or design.

Teilenummer <i>part number</i>	Anschluss- querschnitt <i>terminal cross-section</i>	AWG <i>AWG</i>	Kennzeichnung <i>marking</i>	Crimpzange <i>crimp tool</i>	Crimpbacken <i>crimping dies</i>	Einstelldorn <i>setting gauge</i>
N 02 080 0003 1 	10 mm ²	8	keine Rille <i>no groove</i>	TB 0002	-	Ø 2,8 mm
N 02 080 0004 1 	16 mm ²	6	eine Rille <i>one groove</i>	EK 12042 (Klauke) oder / or AHPW 400C (Neko)	TE 0600 062	-
N 02 080 0005 1 	25 mm ²	4	zwei Rillen <i>two grooves</i>		TE 0600 042	-
N 02 080 0006 1 	35 mm ²	2	drei Rillen <i>three grooves</i>		TE 0600 022	-

Abisolierlänge / *stripping length* : 18 mm

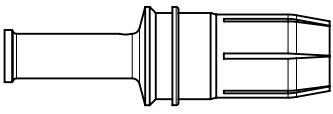
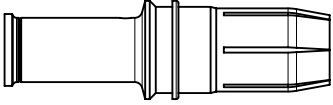
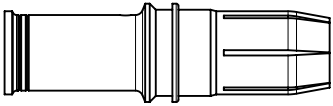
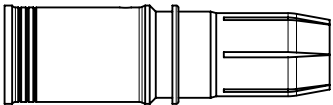
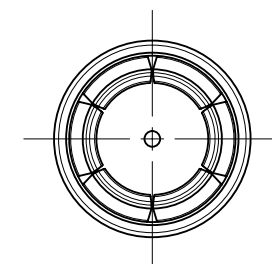
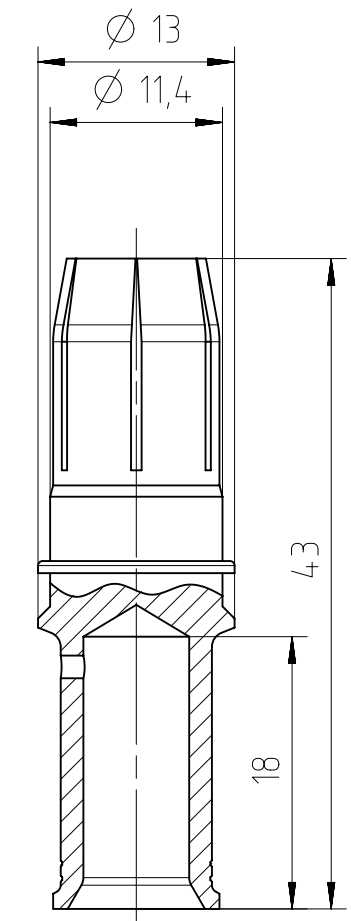
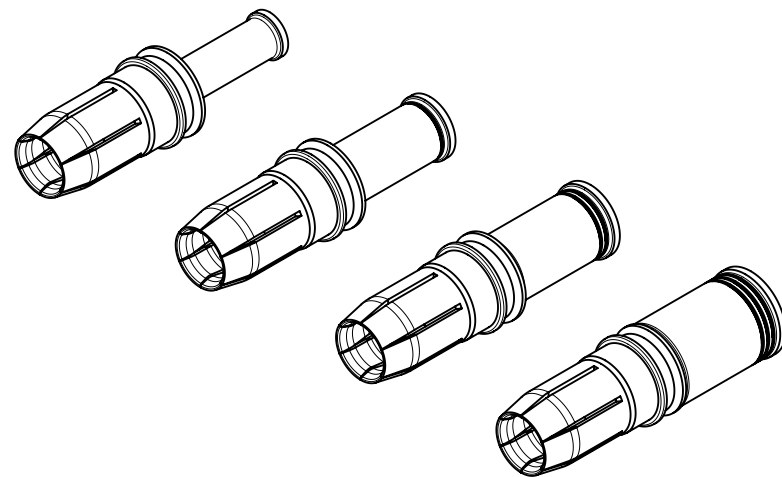

Weitergabe sowie Vervielfältigung dieser Unterlage, Verwertung und Mitteilung ihres Inhalts nicht gestattet, soweit nicht ausdrücklich zugestanden. Zuwiderhandlungen verpflichten zu Schadenersatz. Alle Rechte für den Fall der Patenterteilung oder Gebrauchsmuster-Eintragung vorbehalten.

Gewicht (errechnet) / <i>Calc WT</i> :		Zul. Abw./ <i>Tolerances</i> :		Maßstab / <i>Scale</i> : 1:1	A3	
Prüfmaß / <i>Testdimension</i>		ISO 2768-mH		CUSTOMER DRAWING		
Teileindex <i>Partindexnumber</i>		Datum/ <i>Date</i>		Buchsenkontakt 8 mm <i>pin contact 8 mm</i>		
		Name		M N 02 080 000X 1		
		Gez. / <i>Drawn</i>		Blatt/ <i>Sheet</i>		
		Datum/ <i>Date</i>		1		
		Name		1 Bl.		
		Status: Released		Ers. f. / <i>Replacement for</i> :		
		Inspector: 25.01.2016 MGRIM				
		Amphenol-Tuchel Electronics GmbH				
01	201600001	22.01.2016	PWÖLF			
Index	Änderung/ <i>Description</i>	Datum/ <i>Date</i>	Name			