

INA199B1-B3EVM

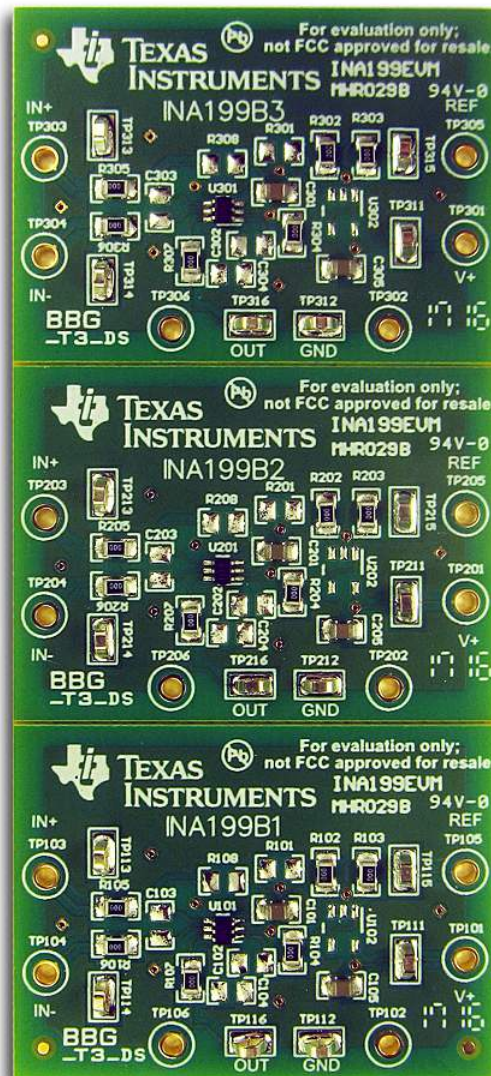

This user's guide describes the characteristics, operation, and use of the INA199 evaluation module (EVM). This EVM is designed to evaluate the performance of the [INA199B1](#), [INA199B2](#), and [INA199B3](#) voltage output current shunt monitors in a variety of configurations. This document also includes a schematic, reference printed circuit board (PCB) layouts, and a complete bill of materials. NOTE: This user guide is for the new revision of the EVM board. For users of the original-version EVM board, see the previous EVM user's guide, [SBOU085](#).

All trademarks are the property of their respective owners.

Contents

1	Overview	3
2	INA199EVM Hardware	3
3	Quick Start Setup and Use	4
4	INA199EVM Circuit	5
5	Reference Voltage Setup	5
6	INA199EVM Schematic and PCB Layout	7
7	Bill of Materials	12

List of Figures

1	INA199EVM Schematic	7
2	INA199EVM Top Overlay	8
3	INA199EVM Top Solder Mask	8
4	INA199EVM Top Layer	8
5	INA199EVM Bottom Layer	8
6	INA199EVM Bottom Solder Mask	9
7	INA199EVM Drill Drawing	9
8	INA199EVM Board Dimensions	10

List of Tables

1	INA199 Device Summary	3
2	INA199EVM Kit Contents	3
3	Related Documentation	3
4	REF Voltage Setup	6
5	Bill of Materials	12

1 Overview

The INA199B1-B3 devices are voltage output, high-side measurement, bi-directional, zero-drift current shunt monitors. This family of devices has gains that range from 50 V/V to 200 V/V. The voltage developed across the device inputs is amplified by the corresponding gain of the specific device and is presented at the output pin. These devices can sense voltage drops across shunts at common-mode voltages from -0.3 V to 26 V , independent of supply voltages. These devices operate with supply voltages between 2.7 V and 26 V and draw a maximum of $100\text{ }\mu\text{A}$. The low offset of the zero-drift architecture enables current sensing with maximum drops across the shunt as low as 10-mV full-scale.

The INA199B1-B3 devices are currently available in an SC70 surface-mount package. [Table 1](#) summarizes the available device options.

Table 1. INA199 Device Summary

Product	Gain
INA199B1	50
INA199B2	100
INA199B3	200

1.1 INA199EVM Kit Contents

[Table 2](#) summarizes the contents of the INA199EVM kit. Contact the [Texas Instruments Product Information Center](#) nearest you if any component is missing. It is highly recommended that you also check the [INA199 device product folder](#) on the TI web site at www.ti.com for any further information regarding this product.

Table 2. INA199EVM Kit Contents

Item	Quantity
INA199 test board	1

1.2 Related Documentation From Texas Instruments

The following document provides information regarding Texas Instruments' integrated circuits used in the assembly of the INA199EVM. This user's guide is available from the TI web site under literature number [SBOU165](#). Any letter appended to the literature number corresponds to the document revision that is current at the time of the writing of this document. Newer revisions are available from www.ti.com, or call the Texas Instruments' Literature Response Center at (800) 477-8924 or the Product Information Center at (972) 644-5580. When ordering, identify the document by both title and literature number.

Table 3. Related Documentation

Document	Literature Number
INA199 product data sheet	SBOS469

2 INA199EVM Hardware

The INA199B1-B3 devices are voltage output, high-side measurement, bi-directional, zero-drift current shunt monitors. The INA199EVM is intended to provide basic functional evaluation of this device family. The fixture layout is not intended to be a model for the target circuit, nor is it laid out for electromagnetic compatibility (EMC) testing. The INA199EVM consists of one PCB with an option to cut out three individual PCBs, one for each of the three devices (INA199B1, INA199B2, and INA199B3). Each of the PCB cutouts consists of the INA199Bx device (where x is 1, 2, and 3) and test points for external hardware connections.

2.1 Features

The layout of the INA199EVM printed circuit board (PCB) is designed to provide the following features:

- Evaluation of all gain options through provided device boards
- Ease of access to device pins with test points
- Space for optional input filtering capacitors and resistors
- Multiple input signal options

Refer to the INA199 data sheet ([SBOS469](#)) for comprehensive information about the INA199 family of devices.

3 Quick Start Setup and Use

Follow these procedures to set up and use the INA199EVM. For the following instructions, $x = 1$ to 3.

- Step 1. Connect an external dc supply voltage between 2.7-V and 26-V to the V+ test point TPx01 or TPx11, and connect ground reference of that supply to the GND test point TPx02 or TPx12. The INA199B1-B3 device output voltage is limited to 50 mV above ground to 200 mV below the supply level.
- Step 2. The REF pin is connected to GND in default board. The voltage applied at the reference input can vary depending on how the device is going to be used. Further details regarding the use of the reference voltage are discussed later in this document.
- Step 3. Connect the input.

3.1 Measurements

The INA199EVM allows the user to either simulate the voltage developed across a sense resistor based on a given set of system conditions, or to connect it remotely to an existing shunt already included in an example application.

To configure a measurement evaluation without a shunt, follow these procedures.

1. Connect a differential voltage to the IN+ (TPx03 or TPx13) and IN– (TPx04 or TPx14) test points. With the reference voltage set at ground, ensure that the IN+ pin is the more positive of the two inputs.
2. Measure the output voltage at the OUT test point (TPx06 or TPx16).

NOTE: The output voltage is equal to the gain of the device multiplied by the differential voltage measured directly at the device input pins.

4 INA199EVM Circuit

This section summarizes the INA199EVM components. For the following instructions, $x = 1$ to 3.

4.1 Rx05, Rx06, Cx03

Rx05 and Rx06 are factory-installed 0- Ω resistors. These resistors, in combination with Cx03, form an input filter. These locations allow for 0805 surface-mount package size. Additional information regarding the use of input filtering is provided in the INA199 product data sheet ([SBOS469](#)).

4.2 Cx05

Cx05 are 0.1- μ F supply bypass capacitors.

4.3 Ux01

Ux01 is the location for the test device. Three device boards are supplied with the INA199EVM board. Each board is populated with one of the available device gains. This option allows users to test the devices and determine the gain setting that is best suited for a given application.

Here is a list of the factors involved in selecting the appropriate device:

- The INA199B1-B3 devices are identical, with the exception of different gain settings.
- The differential input voltage is either applied across the inputs or developed based on the load current that flows through the shunt resistor.
- The limiting factor that requires attention to be given to device selection is the output voltage.
- The selected device must allow the output voltage to remain within the acceptable range after the developed input voltage is amplified by the respective device gain. The output voltage must remain with the range of 50 mV above ground to 200 mV below the supply voltage.
- An output below the minimum allowable output requires the selection of a device with a higher gain. Likewise, an output above the maximum allowable output requires the selection of a device with a lower gain.

4.4 Voltages Inputs

The IN+ (TPx03 or TPx13) and IN- (TPx04 or TPx14) inputs accept a differential voltage that is amplified by the selected device gain and is presented at the OUT test point (TPx06 or TPx16). These inputs could also be used to connect the differential voltage developed across an external shunt in an existing circuit. The acceptable differential input voltage range and polarity are determined by the supply voltage, reference voltage, and gain of the selected device.

5 Reference Voltage Setup

The INA199B1-B3 devices allow for the use of an external reference. This reference determines how the output responds to certain input conditions. The reference also allows these devices to be used in both unidirectional and bi-directional applications.

5.1 Unidirectional Mode

Unidirectional refers to a load current that flows in only one direction. For unidirectional applications, the reference voltage can be set to ground or to 5 V. If the reference is set to ground, the output is set at near ground with no input voltage, and responds to input voltages that are positive with respect to IN- / Load. If the reference is set to 5 V, the output is set near 5 V with no input voltage, and responds to input voltages that are negative with respect to IN- / Load.

5.2 Bi-Directional Mode

Bi-directional refers to a load current that flows in both directions. For bi-directional applications, the reference voltage can be set anywhere within the 0- to 5-V range specified for the reference input. The voltage applied to the reference pin establishes the output voltage of the device with no input voltage. The output voltage is limited by the supply voltage, so there is a greater available range for positive input voltages than negative voltages because the reference voltage is limited to the range of 0 V to 5 V.

The maximum range for the output of this device to accommodate a bi-directional application involves applying 5 V to the reference pin and a supply voltage of 18 V. This configuration allows for a maximum output voltage range of $-4.95\text{ V} / 20.8\text{ V}$ about the 5-V reference.

5.3 REF Pin Configuration

The REF test point (Tx05 or TPx15) allows the user to configure the INA199EVM for either unidirectional or bi-directional operation. The INA199EVM has an external circuit that allows the user to connect different voltages to the REF pin. [Table 4](#) summarizes the possible configurations. In [Table 4](#), $x = 1$ to 3. External components are needed and are listed in [Table 4](#) and [Table 5](#).

Table 4. REF Voltage Setup

Buffer (Not Populated)		Buffer (Populated)	
Rx01 = disconnected Rx02 = 0 Ω Rx03 = 0 Ω	REF = GND (default)	Rx01 = disconnected Rx02 = 0 Ω Rx03 = disconnected	REF = GND
Rx01 = disconnected Rx02 = disconnected Rx03 = 0 Ω	REF = Voltage Selected by the user	Rx01 = disconnected Rx02 = disconnected Rx03 = disconnected	REF = Voltage Selected by the user
Rx01 = 0 Ω Rx02 = disconnected Rx03 = 0 Ω	REF = V+	Rx01 = 0 Ω Rx02 = disconnected Rx03 = disconnected	REF = V+
Rx01 = 5k Ω Rx02 = 5k Ω Rx03 = 0 Ω	REF = V+ / 2	Rx01 = 5k Ω Rx02 = 5k Ω Rx03 = disconnected	REF = V+ / 2

6 INA199EVM Schematic and PCB Layout

NOTE: Board layouts are not to scale. These figures are intended to show how the board is laid out; they are not intended to be used for manufacturing INA199EVM PCBs.

6.1 Schematic

Figure 1 shows the schematic for the INA199EVM PCB.

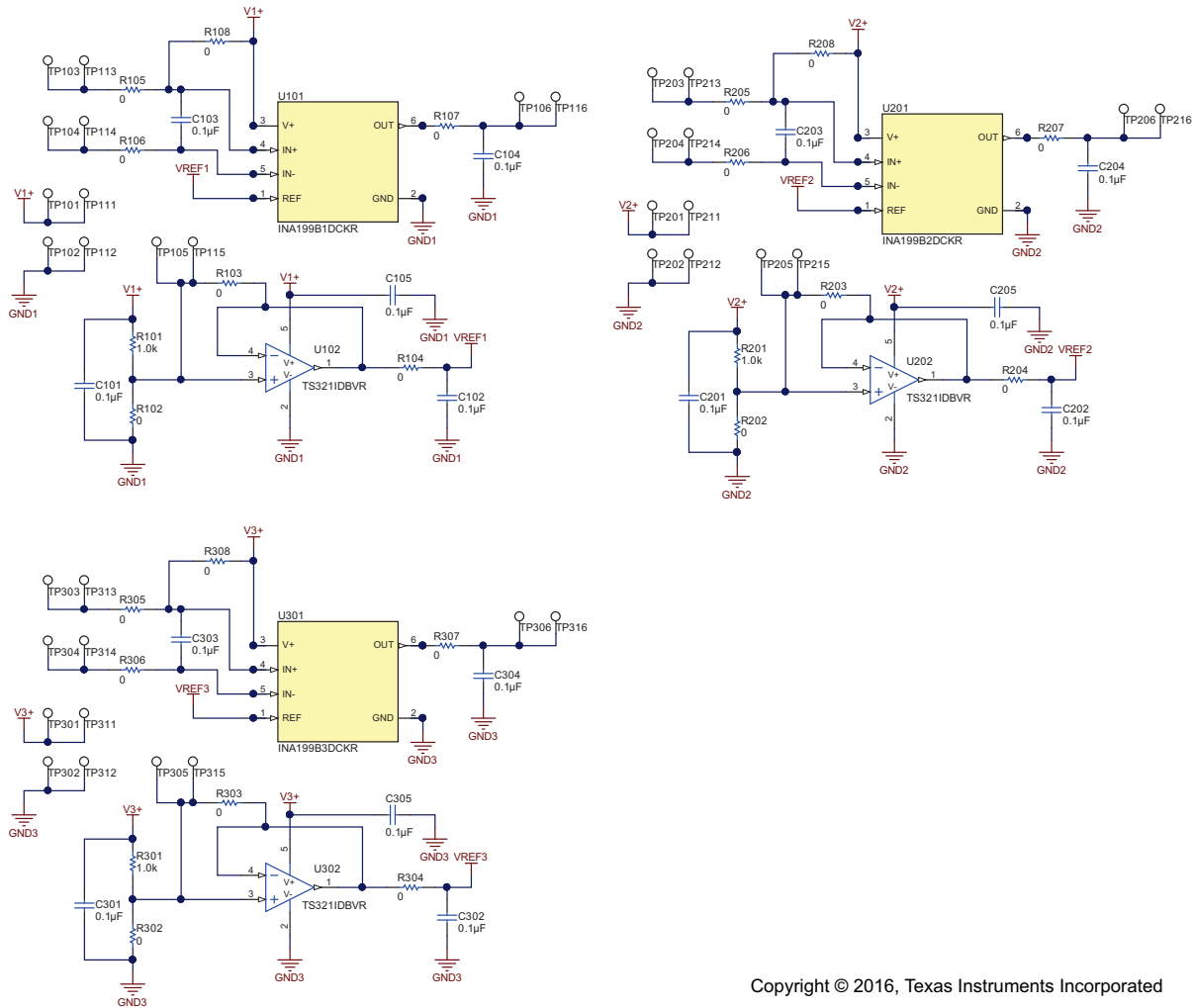

Copyright © 2016, Texas Instruments Incorporated

Figure 1. INA199EVM Schematic

6.2 PCB Layout

Figure 2 through Figure 8 illustrate the PCB layout for the INA199EVM.

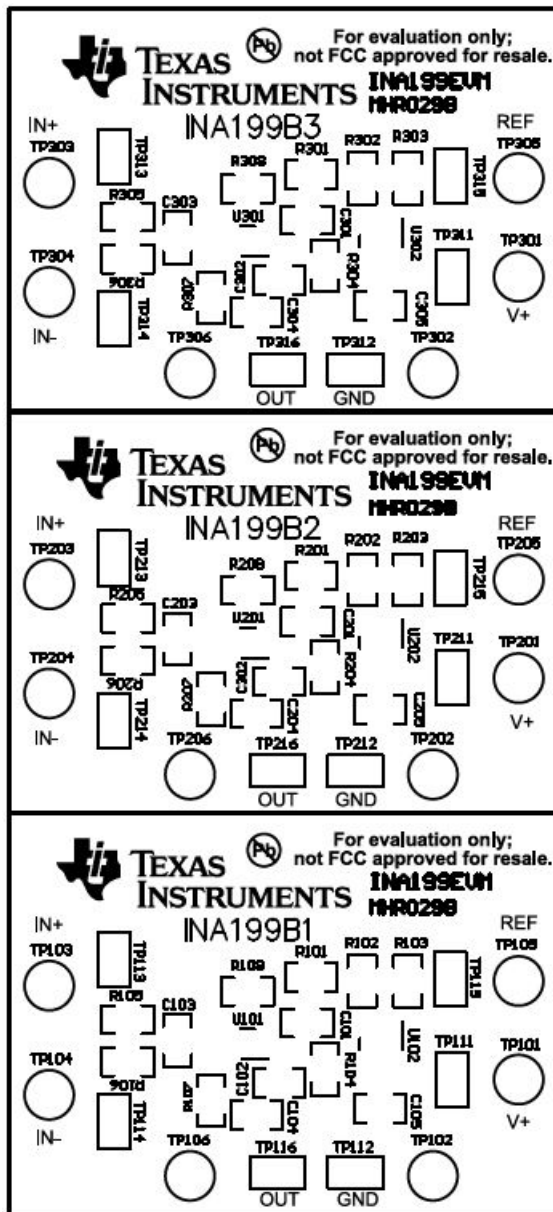

Figure 2. INA199EVM Top Overlay

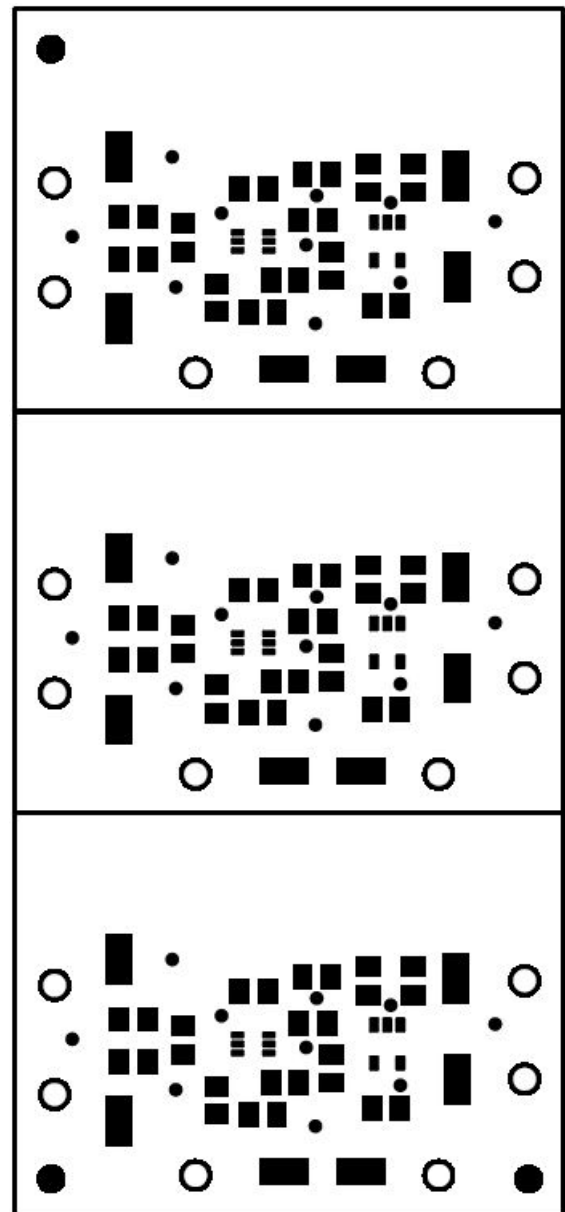

Figure 3. INA199EVM Top Solder Mask

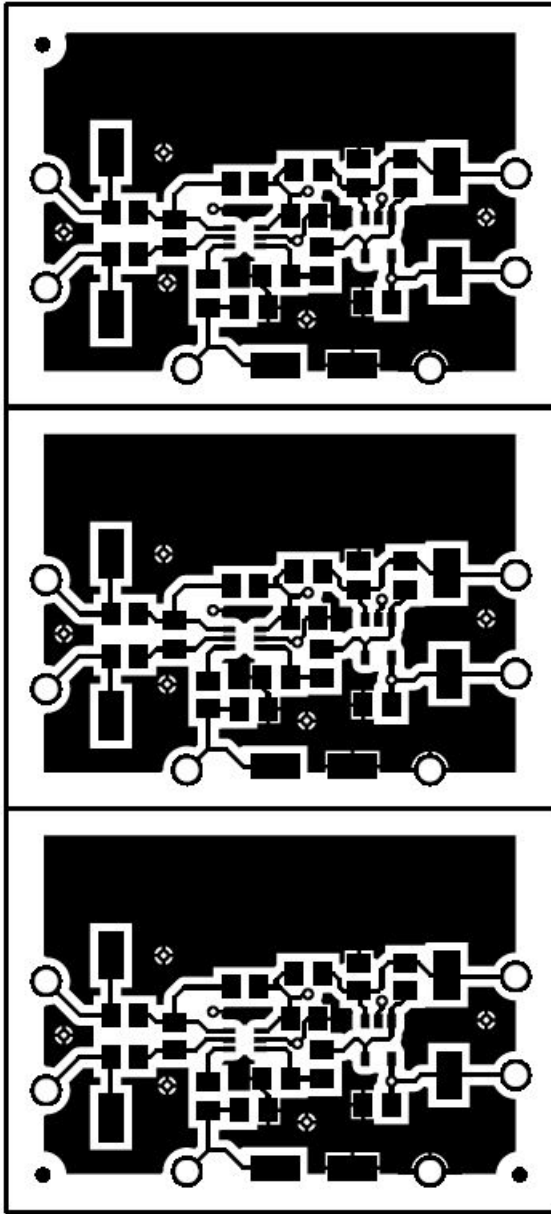

Figure 4. INA199EVM Top Layer

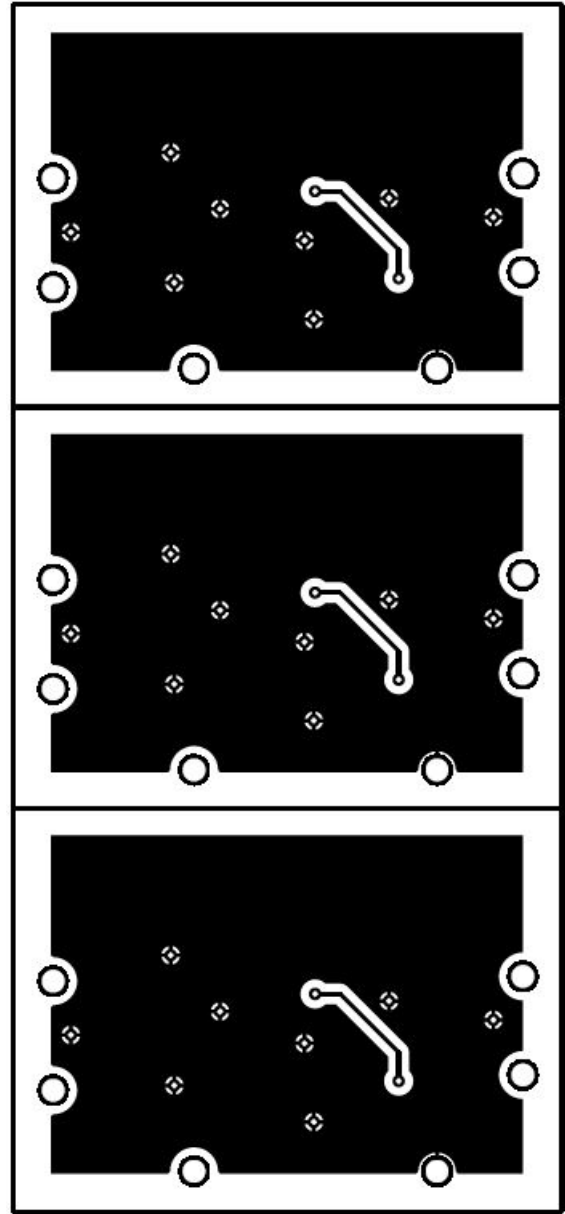

Figure 5. INA199EVM Bottom Layer

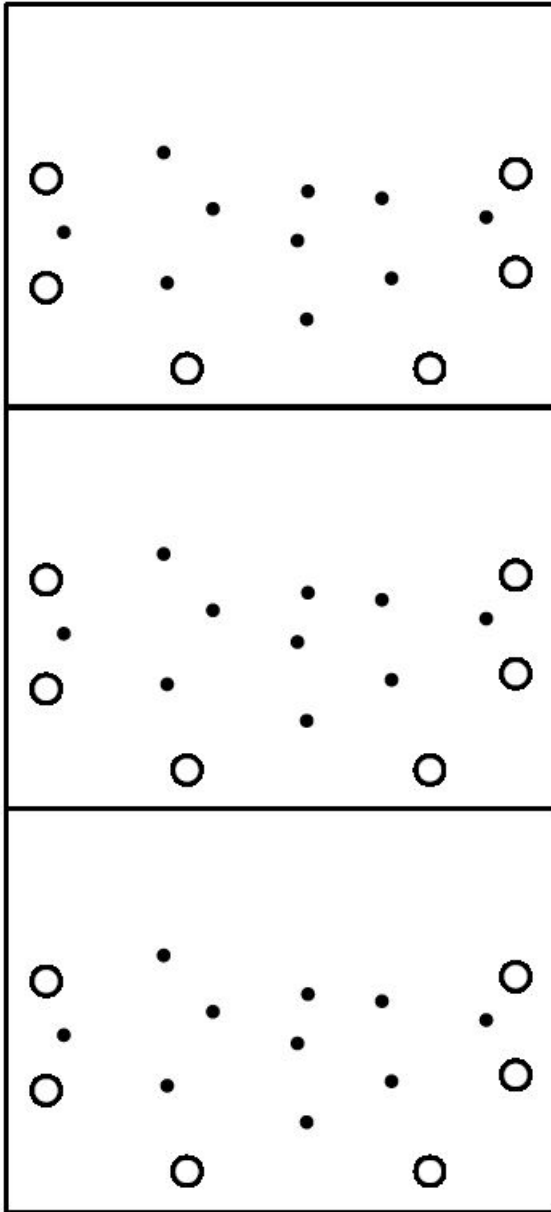

Figure 6. INA199EVM Bottom Solder Mask

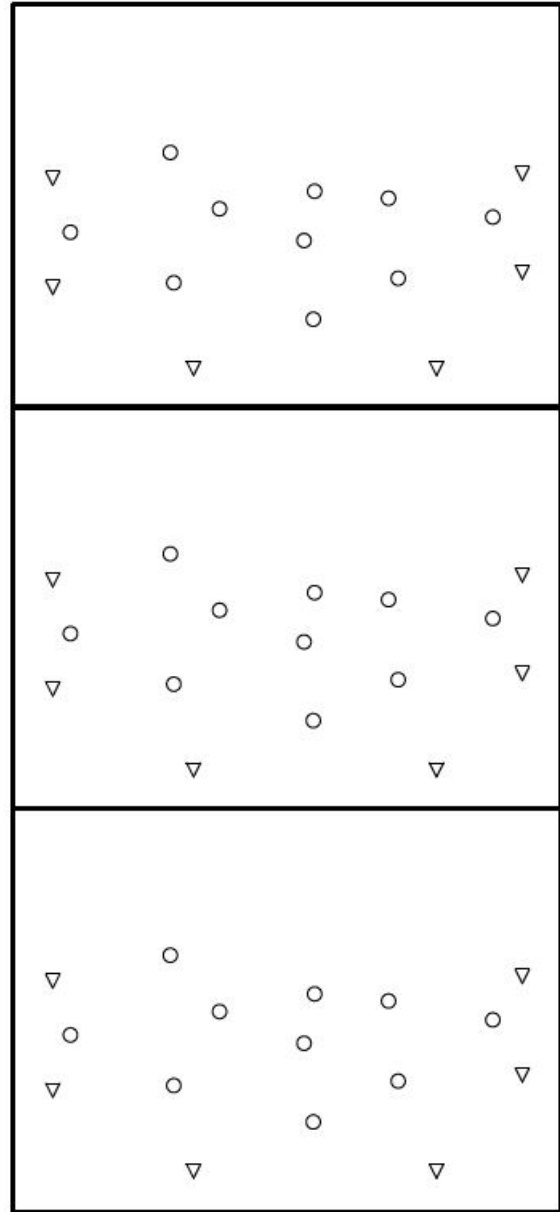

Figure 7. INA199EVM Drill Drawing

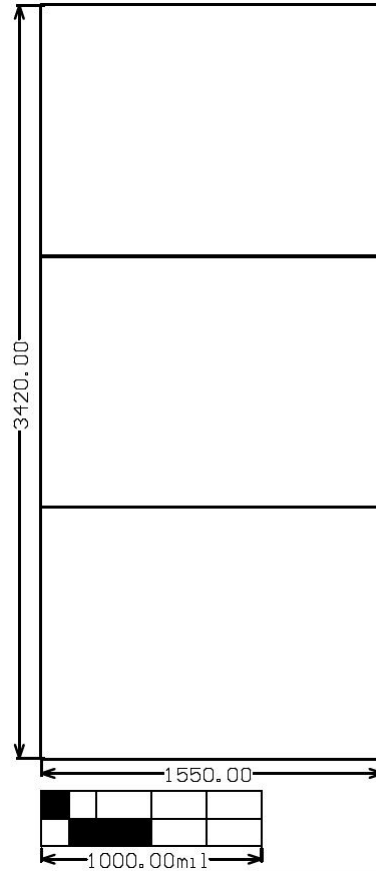

Figure 8. INA199EVM Board Dimensions

7 Bill of Materials

Table 5 provides the parts list for the INA199EVM.

Table 5. Bill of Materials

Qty	RefDes	Value	Description	Part Number	MFR
6	C101, C105, C201, C205, C301, C305	0.1uF	CAP, CERM, 0.1 μ F, 50 V, +/- 5%, X7R, 0805	08055C104JAT2A	AVX
18	R102, R103, R104, R105, R106, R107, R202, R203, R204, R205, R206, R207, R302, R303, R304, R305, R306, R307	0	RES, 0, 5%, 0.125 W, 0805	CRCW08050000Z0EA	Vishay-Dale
18	TP111, TP112, TP113, TP114, TP115, TP116, TP211, TP212, TP213, TP214, TP215, TP216, TP311, TP312, TP313, TP314, TP315, TP316	SMT	Test Point, Miniature, SMT	5015	Keystone
1	U101		26-V, Bidirectional, Zero-Drift, Low- or High-Side, Voltage Output Current Shunt Monitor, DCK0006A	INA199B1DCKR	Texas Instruments
1	U201		26-V, Bidirectional, Zero-Drift, Low- or High-Side, Voltage Output Current Shunt Monitor, DCK0006A	INA199B2DCKR	Texas Instruments
1	U301		26-V, Bidirectional, Zero-Drift, Low- or High-Side, Voltage Output Current Shunt Monitor, DCK0006A	INA199B3DCKR	Texas Instruments
0	C102, C103, C104, C202, C203, C204, C302, C303, C304	0.1uF	CAP, CERM, 0.1 μ F, 50 V, +/- 5%, X7R, 0805	08055C104JAT2A	AVX
0	R101, R201, R301	1.0k	RES, 1.0 k, 5%, 0.125 W, 0805	CRCW08051K00JNEA	Vishay-Dale
0	R108, R208, R308	0	RES, 0, 5%, 0.125 W, 0805	CRCW08050000Z0EA	Vishay-Dale
0	TP101, TP102, TP103, TP104, TP105, TP106, TP201, TP202, TP203, TP204, TP205, TP206, TP301, TP302, TP303, TP304, TP305, TP306	White	Test Point, Compact, White, TH	5007	Keystone
0	U102, U202, U302		LOW-POWER SINGLE OPERATIONAL AMPLIFIER, DBV0005A	TS321IDBVR	Texas Instruments

STANDARD TERMS AND CONDITIONS FOR EVALUATION MODULES

1. *Delivery:* TI delivers TI evaluation boards, kits, or modules, including any accompanying demonstration software, components, or documentation (collectively, an "EVM" or "EVMs") to the User ("User") in accordance with the terms and conditions set forth herein. Acceptance of the EVM is expressly subject to the following terms and conditions.
 - 1.1 EVMs are intended solely for product or software developers for use in a research and development setting to facilitate feasibility evaluation, experimentation, or scientific analysis of TI semiconductors products. EVMs have no direct function and are not finished products. EVMs shall not be directly or indirectly assembled as a part or subassembly in any finished product. For clarification, any software or software tools provided with the EVM ("Software") shall not be subject to the terms and conditions set forth herein but rather shall be subject to the applicable terms and conditions that accompany such Software
 - 1.2 EVMs are not intended for consumer or household use. EVMs may not be sold, sublicensed, leased, rented, loaned, assigned, or otherwise distributed for commercial purposes by Users, in whole or in part, or used in any finished product or production system.
2. *Limited Warranty and Related Remedies/Disclaimers:*
 - 2.1 These terms and conditions do not apply to Software. The warranty, if any, for Software is covered in the applicable Software License Agreement.
 - 2.2 TI warrants that the TI EVM will conform to TI's published specifications for ninety (90) days after the date TI delivers such EVM to User. Notwithstanding the foregoing, TI shall not be liable for any defects that are caused by neglect, misuse or mistreatment by an entity other than TI, including improper installation or testing, or for any EVMs that have been altered or modified in any way by an entity other than TI. Moreover, TI shall not be liable for any defects that result from User's design, specifications or instructions for such EVMs. Testing and other quality control techniques are used to the extent TI deems necessary or as mandated by government requirements. TI does not test all parameters of each EVM.
 - 2.3 If any EVM fails to conform to the warranty set forth above, TI's sole liability shall be at its option to repair or replace such EVM, or credit User's account for such EVM. TI's liability under this warranty shall be limited to EVMs that are returned during the warranty period to the address designated by TI and that are determined by TI not to conform to such warranty. If TI elects to repair or replace such EVM, TI shall have a reasonable time to repair such EVM or provide replacements. Repaired EVMs shall be warranted for the remainder of the original warranty period. Replaced EVMs shall be warranted for a new full ninety (90) day warranty period.
3. *Regulatory Notices:*
 - 3.1 *United States*
 - 3.1.1 *Notice applicable to EVMs not FCC-Approved:*

This kit is designed to allow product developers to evaluate electronic components, circuitry, or software associated with the kit to determine whether to incorporate such items in a finished product and software developers to write software applications for use with the end product. This kit is not a finished product and when assembled may not be resold or otherwise marketed unless all required FCC equipment authorizations are first obtained. Operation is subject to the condition that this product not cause harmful interference to licensed radio stations and that this product accept harmful interference. Unless the assembled kit is designed to operate under part 15, part 18 or part 95 of this chapter, the operator of the kit must operate under the authority of an FCC license holder or must secure an experimental authorization under part 5 of this chapter.
 - 3.1.2 *For EVMs annotated as FCC – FEDERAL COMMUNICATIONS COMMISSION Part 15 Compliant:*

CAUTION

This device complies with part 15 of the FCC Rules. Operation is subject to the following two conditions: (1) This device may not cause harmful interference, and (2) this device must accept any interference received, including interference that may cause undesired operation.

Changes or modifications not expressly approved by the party responsible for compliance could void the user's authority to operate the equipment.

FCC Interference Statement for Class A EVM devices

NOTE: This equipment has been tested and found to comply with the limits for a Class A digital device, pursuant to part 15 of the FCC Rules. These limits are designed to provide reasonable protection against harmful interference when the equipment is operated in a commercial environment. This equipment generates, uses, and can radiate radio frequency energy and, if not installed and used in accordance with the instruction manual, may cause harmful interference to radio communications. Operation of this equipment in a residential area is likely to cause harmful interference in which case the user will be required to correct the interference at his own expense.

FCC Interference Statement for Class B EVM devices

NOTE: This equipment has been tested and found to comply with the limits for a Class B digital device, pursuant to part 15 of the FCC Rules. These limits are designed to provide reasonable protection against harmful interference in a residential installation. This equipment generates, uses and can radiate radio frequency energy and, if not installed and used in accordance with the instructions, may cause harmful interference to radio communications. However, there is no guarantee that interference will not occur in a particular installation. If this equipment does cause harmful interference to radio or television reception, which can be determined by turning the equipment off and on, the user is encouraged to try to correct the interference by one or more of the following measures:

- Reorient or relocate the receiving antenna.
- Increase the separation between the equipment and receiver.
- Connect the equipment into an outlet on a circuit different from that to which the receiver is connected.
- Consult the dealer or an experienced radio/TV technician for help.

3.2 Canada

3.2.1 For EVMs issued with an Industry Canada Certificate of Conformance to RSS-210

Concerning EVMs Including Radio Transmitters:

This device complies with Industry Canada license-exempt RSS standard(s). Operation is subject to the following two conditions: (1) this device may not cause interference, and (2) this device must accept any interference, including interference that may cause undesired operation of the device.

Concernant les EVMs avec appareils radio:

Le présent appareil est conforme aux CNR d'Industrie Canada applicables aux appareils radio exempts de licence. L'exploitation est autorisée aux deux conditions suivantes: (1) l'appareil ne doit pas produire de brouillage, et (2) l'utilisateur de l'appareil doit accepter tout brouillage radioélectrique subi, même si le brouillage est susceptible d'en compromettre le fonctionnement.

Concerning EVMs Including Detachable Antennas:

Under Industry Canada regulations, this radio transmitter may only operate using an antenna of a type and maximum (or lesser) gain approved for the transmitter by Industry Canada. To reduce potential radio interference to other users, the antenna type and its gain should be so chosen that the equivalent isotropically radiated power (e.i.r.p.) is not more than that necessary for successful communication. This radio transmitter has been approved by Industry Canada to operate with the antenna types listed in the user guide with the maximum permissible gain and required antenna impedance for each antenna type indicated. Antenna types not included in this list, having a gain greater than the maximum gain indicated for that type, are strictly prohibited for use with this device.

Concernant les EVMs avec antennes détachables

Conformément à la réglementation d'Industrie Canada, le présent émetteur radio peut fonctionner avec une antenne d'un type et d'un gain maximal (ou inférieur) approuvé pour l'émetteur par Industrie Canada. Dans le but de réduire les risques de brouillage radioélectrique à l'intention des autres utilisateurs, il faut choisir le type d'antenne et son gain de sorte que la puissance isotrope rayonnée équivalente (p.i.r.e.) ne dépasse pas l'intensité nécessaire à l'établissement d'une communication satisfaisante. Le présent émetteur radio a été approuvé par Industrie Canada pour fonctionner avec les types d'antenne énumérés dans le manuel d'usage et ayant un gain admissible maximal et l'impédance requise pour chaque type d'antenne. Les types d'antenne non inclus dans cette liste, ou dont le gain est supérieur au gain maximal indiqué, sont strictement interdits pour l'exploitation de l'émetteur.

3.3 Japan

3.3.1 *Notice for EVMs delivered in Japan:* Please see http://www.tij.co.jp/lstds/ti_ja/general/eStore/notice_01.page 日本国内に輸入される評価用キット、ボードについては、次のところをご覧ください。
http://www.tij.co.jp/lstds/ti_ja/general/eStore/notice_01.page

3.3.2 *Notice for Users of EVMs Considered "Radio Frequency Products" in Japan:* EVMs entering Japan may not be certified by TI as conforming to Technical Regulations of Radio Law of Japan.

If User uses EVMs in Japan, not certified to Technical Regulations of Radio Law of Japan, User is required by Radio Law of Japan to follow the instructions below with respect to EVMs:

1. Use EVMs in a shielded room or any other test facility as defined in the notification #173 issued by Ministry of Internal Affairs and Communications on March 28, 2006, based on Sub-section 1.1 of Article 6 of the Ministry's Rule for Enforcement of Radio Law of Japan,
2. Use EVMs only after User obtains the license of Test Radio Station as provided in Radio Law of Japan with respect to EVMs, or
3. Use of EVMs only after User obtains the Technical Regulations Conformity Certification as provided in Radio Law of Japan with respect to EVMs. Also, do not transfer EVMs, unless User gives the same notice above to the transferee. Please note that if User does not follow the instructions above, User will be subject to penalties of Radio Law of Japan.

【無線電波を送信する製品の開発キットをお使いになる際の注意事項】 開発キットの中には技術基準適合証明を受けていないものがあります。技術適合証明を受けていないものご使用に際しては、電波法遵守のため、以下のいずれかの措置を取っていただく必要がありますのでご注意ください。

1. 電波法施行規則第6条第1項第1号に基づく平成18年3月28日総務省告示第173号で定められた電波暗室等の試験設備でご使用いただく。
2. 実験局の免許を取得後ご使用いただく。
3. 技術基準適合証明を取得後ご使用いただく。

なお、本製品は、上記の「ご使用にあたっての注意」を譲渡先、移転先に通知しない限り、譲渡、移転できないものとします。

上記を遵守頂けない場合は、電波法の罰則が適用される可能性があることをご留意ください。日本テキサス・インスツルメンツ株式会社

東京都新宿区西新宿 6 丁目 2 4 番 1 号

西新宿三井ビル

3.3.3 *Notice for EVMs for Power Line Communication:* Please see http://www.tij.co.jp/llds/ti_ja/general/eStore/notice_02.page

電力線搬送波通信についての開発キットをお使いになる際の注意事項については、次のところをご覧ください。http://www.tij.co.jp/llds/ti_ja/general/eStore/notice_02.page

4 *EVM Use Restrictions and Warnings:*

4.1 EVMS ARE NOT FOR USE IN FUNCTIONAL SAFETY AND/OR SAFETY CRITICAL EVALUATIONS, INCLUDING BUT NOT LIMITED TO EVALUATIONS OF LIFE SUPPORT APPLICATIONS.

4.2 User must read and apply the user guide and other available documentation provided by TI regarding the EVM prior to handling or using the EVM, including without limitation any warning or restriction notices. The notices contain important safety information related to, for example, temperatures and voltages.

4.3 *Safety-Related Warnings and Restrictions:*

4.3.1 User shall operate the EVM within TI's recommended specifications and environmental considerations stated in the user guide, other available documentation provided by TI, and any other applicable requirements and employ reasonable and customary safeguards. Exceeding the specified performance ratings and specifications (including but not limited to input and output voltage, current, power, and environmental ranges) for the EVM may cause personal injury or death, or property damage. If there are questions concerning performance ratings and specifications, User should contact a TI field representative prior to connecting interface electronics including input power and intended loads. Any loads applied outside of the specified output range may also result in unintended and/or inaccurate operation and/or possible permanent damage to the EVM and/or interface electronics. Please consult the EVM user guide prior to connecting any load to the EVM output. If there is uncertainty as to the load specification, please contact a TI field representative. During normal operation, even with the inputs and outputs kept within the specified allowable ranges, some circuit components may have elevated case temperatures. These components include but are not limited to linear regulators, switching transistors, pass transistors, current sense resistors, and heat sinks, which can be identified using the information in the associated documentation. When working with the EVM, please be aware that the EVM may become very warm.

4.3.2 EVMs are intended solely for use by technically qualified, professional electronics experts who are familiar with the dangers and application risks associated with handling electrical mechanical components, systems, and subsystems. User assumes all responsibility and liability for proper and safe handling and use of the EVM by User or its employees, affiliates, contractors or designees. User assumes all responsibility and liability to ensure that any interfaces (electronic and/or mechanical) between the EVM and any human body are designed with suitable isolation and means to safely limit accessible leakage currents to minimize the risk of electrical shock hazard. User assumes all responsibility and liability for any improper or unsafe handling or use of the EVM by User or its employees, affiliates, contractors or designees.

4.4 User assumes all responsibility and liability to determine whether the EVM is subject to any applicable international, federal, state, or local laws and regulations related to User's handling and use of the EVM and, if applicable, User assumes all responsibility and liability for compliance in all respects with such laws and regulations. User assumes all responsibility and liability for proper disposal and recycling of the EVM consistent with all applicable international, federal, state, and local requirements.

5. *Accuracy of Information:* To the extent TI provides information on the availability and function of EVMs, TI attempts to be as accurate as possible. However, TI does not warrant the accuracy of EVM descriptions, EVM availability or other information on its websites as accurate, complete, reliable, current, or error-free.

6. *Disclaimers:*
- 6.1 EXCEPT AS SET FORTH ABOVE, EVMS AND ANY WRITTEN DESIGN MATERIALS PROVIDED WITH THE EVM (AND THE DESIGN OF THE EVM ITSELF) ARE PROVIDED "AS IS" AND "WITH ALL FAULTS." TI DISCLAIMS ALL OTHER WARRANTIES, EXPRESS OR IMPLIED, REGARDING SUCH ITEMS, INCLUDING BUT NOT LIMITED TO ANY IMPLIED WARRANTIES OF MERCHANTABILITY OR FITNESS FOR A PARTICULAR PURPOSE OR NON-INFRINGEMENT OF ANY THIRD PARTY PATENTS, COPYRIGHTS, TRADE SECRETS OR OTHER INTELLECTUAL PROPERTY RIGHTS.
- 6.2 EXCEPT FOR THE LIMITED RIGHT TO USE THE EVM SET FORTH HEREIN, NOTHING IN THESE TERMS AND CONDITIONS SHALL BE CONSTRUED AS GRANTING OR CONFERRING ANY RIGHTS BY LICENSE, PATENT, OR ANY OTHER INDUSTRIAL OR INTELLECTUAL PROPERTY RIGHT OF TI, ITS SUPPLIERS/LICENSORS OR ANY OTHER THIRD PARTY, TO USE THE EVM IN ANY FINISHED END-USER OR READY-TO-USE FINAL PRODUCT, OR FOR ANY INVENTION, DISCOVERY OR IMPROVEMENT MADE, CONCEIVED OR ACQUIRED PRIOR TO OR AFTER DELIVERY OF THE EVM.
7. *USER'S INDEMNITY OBLIGATIONS AND REPRESENTATIONS.* USER WILL DEFEND, INDEMNIFY AND HOLD TI, ITS LICENSORS AND THEIR REPRESENTATIVES HARMLESS FROM AND AGAINST ANY AND ALL CLAIMS, DAMAGES, LOSSES, EXPENSES, COSTS AND LIABILITIES (COLLECTIVELY, "CLAIMS") ARISING OUT OF OR IN CONNECTION WITH ANY HANDLING OR USE OF THE EVM THAT IS NOT IN ACCORDANCE WITH THESE TERMS AND CONDITIONS. THIS OBLIGATION SHALL APPLY WHETHER CLAIMS ARISE UNDER STATUTE, REGULATION, OR THE LAW OF TORT, CONTRACT OR ANY OTHER LEGAL THEORY, AND EVEN IF THE EVM FAILS TO PERFORM AS DESCRIBED OR EXPECTED.
8. *Limitations on Damages and Liability:*
- 8.1 *General Limitations.* IN NO EVENT SHALL TI BE LIABLE FOR ANY SPECIAL, COLLATERAL, INDIRECT, PUNITIVE, INCIDENTAL, CONSEQUENTIAL, OR EXEMPLARY DAMAGES IN CONNECTION WITH OR ARISING OUT OF THESE TERMS AND CONDITIONS OR THE USE OF THE EVMS PROVIDED HEREUNDER, REGARDLESS OF WHETHER TI HAS BEEN ADVISED OF THE POSSIBILITY OF SUCH DAMAGES. EXCLUDED DAMAGES INCLUDE, BUT ARE NOT LIMITED TO, COST OF REMOVAL OR REINSTALLATION, ANCILLARY COSTS TO THE PROCUREMENT OF SUBSTITUTE GOODS OR SERVICES, RETESTING, OUTSIDE COMPUTER TIME, LABOR COSTS, LOSS OF GOODWILL, LOSS OF PROFITS, LOSS OF SAVINGS, LOSS OF USE, LOSS OF DATA, OR BUSINESS INTERRUPTION. NO CLAIM, SUIT OR ACTION SHALL BE BROUGHT AGAINST TI MORE THAN ONE YEAR AFTER THE RELATED CAUSE OF ACTION HAS OCCURRED.
- 8.2 *Specific Limitations.* IN NO EVENT SHALL TI'S AGGREGATE LIABILITY FROM ANY WARRANTY OR OTHER OBLIGATION ARISING OUT OF OR IN CONNECTION WITH THESE TERMS AND CONDITIONS, OR ANY USE OF ANY TI EVM PROVIDED HEREUNDER, EXCEED THE TOTAL AMOUNT PAID TO TI FOR THE PARTICULAR UNITS SOLD UNDER THESE TERMS AND CONDITIONS WITH RESPECT TO WHICH LOSSES OR DAMAGES ARE CLAIMED. THE EXISTENCE OF MORE THAN ONE CLAIM AGAINST THE PARTICULAR UNITS SOLD TO USER UNDER THESE TERMS AND CONDITIONS SHALL NOT ENLARGE OR EXTEND THIS LIMIT.
9. *Return Policy.* Except as otherwise provided, TI does not offer any refunds, returns, or exchanges. Furthermore, no return of EVM(s) will be accepted if the package has been opened and no return of the EVM(s) will be accepted if they are damaged or otherwise not in a resalable condition. If User feels it has been incorrectly charged for the EVM(s) it ordered or that delivery violates the applicable order, User should contact TI. All refunds will be made in full within thirty (30) working days from the return of the components(s), excluding any postage or packaging costs.
10. *Governing Law:* These terms and conditions shall be governed by and interpreted in accordance with the laws of the State of Texas, without reference to conflict-of-laws principles. User agrees that non-exclusive jurisdiction for any dispute arising out of or relating to these terms and conditions lies within courts located in the State of Texas and consents to venue in Dallas County, Texas. Notwithstanding the foregoing, any judgment may be enforced in any United States or foreign court, and TI may seek injunctive relief in any United States or foreign court.

Mailing Address: Texas Instruments, Post Office Box 655303, Dallas, Texas 75265
Copyright © 2015, Texas Instruments Incorporated

IMPORTANT NOTICE

Texas Instruments Incorporated and its subsidiaries (TI) reserve the right to make corrections, enhancements, improvements and other changes to its semiconductor products and services per JESD46, latest issue, and to discontinue any product or service per JESD48, latest issue. Buyers should obtain the latest relevant information before placing orders and should verify that such information is current and complete. All semiconductor products (also referred to herein as "components") are sold subject to TI's terms and conditions of sale supplied at the time of order acknowledgment.

TI warrants performance of its components to the specifications applicable at the time of sale, in accordance with the warranty in TI's terms and conditions of sale of semiconductor products. Testing and other quality control techniques are used to the extent TI deems necessary to support this warranty. Except where mandated by applicable law, testing of all parameters of each component is not necessarily performed.

TI assumes no liability for applications assistance or the design of Buyers' products. Buyers are responsible for their products and applications using TI components. To minimize the risks associated with Buyers' products and applications, Buyers should provide adequate design and operating safeguards.

TI does not warrant or represent that any license, either express or implied, is granted under any patent right, copyright, mask work right, or other intellectual property right relating to any combination, machine, or process in which TI components or services are used. Information published by TI regarding third-party products or services does not constitute a license to use such products or services or a warranty or endorsement thereof. Use of such information may require a license from a third party under the patents or other intellectual property of the third party, or a license from TI under the patents or other intellectual property of TI.

Reproduction of significant portions of TI information in TI data books or data sheets is permissible only if reproduction is without alteration and is accompanied by all associated warranties, conditions, limitations, and notices. TI is not responsible or liable for such altered documentation. Information of third parties may be subject to additional restrictions.

Resale of TI components or services with statements different from or beyond the parameters stated by TI for that component or service voids all express and any implied warranties for the associated TI component or service and is an unfair and deceptive business practice. TI is not responsible or liable for any such statements.

Buyer acknowledges and agrees that it is solely responsible for compliance with all legal, regulatory and safety-related requirements concerning its products, and any use of TI components in its applications, notwithstanding any applications-related information or support that may be provided by TI. Buyer represents and agrees that it has all the necessary expertise to create and implement safeguards which anticipate dangerous consequences of failures, monitor failures and their consequences, lessen the likelihood of failures that might cause harm and take appropriate remedial actions. Buyer will fully indemnify TI and its representatives against any damages arising out of the use of any TI components in safety-critical applications.

In some cases, TI components may be promoted specifically to facilitate safety-related applications. With such components, TI's goal is to help enable customers to design and create their own end-product solutions that meet applicable functional safety standards and requirements. Nonetheless, such components are subject to these terms.

No TI components are authorized for use in FDA Class III (or similar life-critical medical equipment) unless authorized officers of the parties have executed a special agreement specifically governing such use.

Only those TI components which TI has specifically designated as military grade or "enhanced plastic" are designed and intended for use in military/aerospace applications or environments. Buyer acknowledges and agrees that any military or aerospace use of TI components which have **not** been so designated is solely at the Buyer's risk, and that Buyer is solely responsible for compliance with all legal and regulatory requirements in connection with such use.

TI has specifically designated certain components as meeting ISO/TS16949 requirements, mainly for automotive use. In any case of use of non-designated products, TI will not be responsible for any failure to meet ISO/TS16949.

Products

Audio	www.ti.com/audio
Amplifiers	amplifier.ti.com
Data Converters	dataconverter.ti.com
DLP® Products	www.dlp.com
DSP	dsp.ti.com
Clocks and Timers	www.ti.com/clocks
Interface	interface.ti.com
Logic	logic.ti.com
Power Mgmt	power.ti.com
Microcontrollers	microcontroller.ti.com
RFID	www.ti-rfid.com
OMAP Applications Processors	www.ti.com/omap
Wireless Connectivity	www.ti.com/wirelessconnectivity

Applications

Automotive and Transportation	www.ti.com/automotive
Communications and Telecom	www.ti.com/communications
Computers and Peripherals	www.ti.com/computers
Consumer Electronics	www.ti.com/consumer-apps
Energy and Lighting	www.ti.com/energy
Industrial	www.ti.com/industrial
Medical	www.ti.com/medical
Security	www.ti.com/security
Space, Avionics and Defense	www.ti.com/space-avionics-defense
Video and Imaging	www.ti.com/video

TI E2E Community

e2e.ti.com