

SUMMARY



Image is for illustrative purpose only

Wires

Quad 1

Series 1D
Termination type Female solder
IP rating 50
AWG wire size 0.00 - 0.00
Cable Ø 4.10 - 5.00 mm
Status **obsolete**
Matching parts [ERN.1D.694.CNA](#)

Download

[Request a quote](#)
[Catalog](#)

TECHNICAL DETAILS

Mechanics

Shell Style/Model FFA*: Straight plug, cable collet and nut for fitting a bend relief
Keying
Housing Material Brass (chrome plated [SAE AMS 2460]) shell and collet nut, nickel plated [SAE AMS QQ N 290] brass latch sleeve and mid pieces
Variant Z : Nut for fitting a bend relief
Weight 16.19 g

Performance

Configuration 1D.694 : 1 Quadrax
Insulator N: PBT
Rated Current

Specifications

Contact Type: Solder
Vtest (contact-shell): 420 V (AC), 600 V (DC)
Vtest (contact-contact): 420 V (AC), 600 V (DC)

Others

Endurance (Shell): 1000 mating cycles

LEMO products and services are provided "as is". LEMO makes no warranties or representations with regard to LEMO product & services or use of them, express, implied or statutory, including for accuracy, completeness, or security. The user is fully responsible for his products and applications using LEMO components.

Temp (min / max): -40°C / +120°C
Insulating res.: 10e11 Ohms
Shielding (min): 35 dB (1 GHz)
Shielding (min): 70dB (10 MHz)
Salt Spray Corrosion: >1000 hr

DRAWINGS

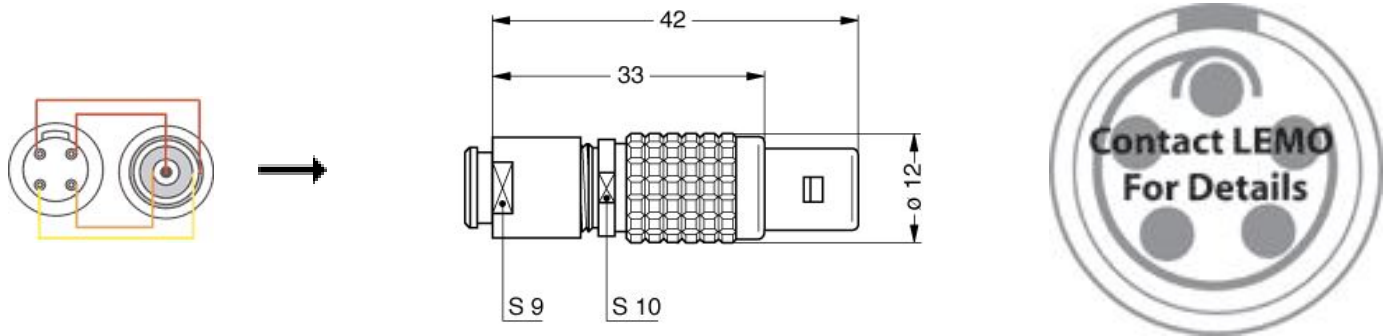

Dimensions

	A	L	M
mm.	12	42	33
in.	0,47	1,65	1,30

RECOMMENDED BY LEMO

Tools

LEMO products and services are provided "as is". LEMO makes no warranties or representations with regard to LEMO product & services or use of them, express, implied or statutory, including for accuracy, completeness, or security. The user is fully responsible for his products and applications using LEMO components.