

Superior high Flux for High Voltage System

High-Power LED - 5050 6V Series

S1W0-5050xxxx06-00000000-00002



Product Brief

Description

- This White Colored surface-mount LED comes in standard package dimension. Package Size : 5.0x5.0x0.7mm
- It has a substrate made up of a molded plastic reflector sitting on top of a lead frame.
- The die is attached within the reflector cavity and the cavity is encapsulated by silicone.
- The package design coupled with careful selection of component materials allow these products to perform with high reliability

Features and Benefits

- High Intensity output and high luminance
- Designed for high voltage operation
- SMT solderable
- RoHS compliant
- Color coordinate: 2200K-6500K,CRI70
2700K-6500K,CRI80
- CRI line up 70& 80

Key Applications

- General lighting
- Architectural lighting
- LED Bulbs
- Decorative / Pathway lighting

Table 1-1. Product Selection Table

Reference Code	Color	Nominal CCT	Part Number	CRI
				Min
STW0L8PA	Cool White	6500K	S1W0-5050657006-00000000-00002	70
		5700K	S1W0-5050577006-00000000-00002	
		5000K	S1W0-5050507006-00000000-00002	
	Neutral White	4000K	S1W0-5050407006-00000000-00002	
		3500K	S1W0-5050357006-00000000-00002	
		Warm White	3000K	
	2700K		S1W0-5050277006-00000000-00002	
	2200K		S1W0-5050227006-00000000-00002	



Table 1-2. Product Selection Table

Reference Code	Color	Nominal CCT	Part Number	CRI
				Min
STW8L8PA	Cool White	6500K	S1W0-5050658006-00000000-00002	80
		5700K	S1W0-5050578006-00000000-00002	
		5000K	S1W0-5050508006-00000000-00002	
	Neutral White	4000K	S1W0-5050408006-00000000-00002	
	Warm White	3500K	S1W0-5050358006-00000000-00002	
		3000K	S1W0-5050308006-00000000-00002	
		2700K	S1W0-5050278006-00000000-00002	

Table of Contents

Index		
•	Product Brief	1
•	Table of Contents	3
•	Performance Characteristics	4
•	Characteristics Graph	6
•	Color Bin Structure	19
•	Mechanical Dimensions	25
•	Recommended Solder Pad	26
•	Reflow Soldering Characteristics	27
•	Emitter Tape & Reel Packaging	28
•	Product Nomenclature	30
•	Handling of Silicone Resin for LEDs	31
•	Precaution For Use	32
•	Company Information	35

Product Performance & Characterization Guide

Table 2. Product Selection Guide, $I_F = 640\text{mA}$, $T_j = 25^\circ\text{C}$, RH30%

Min. CRI, $R_a^{[4]}$	Nominal CCT [K] ^[1]	Min. Flux [lm] @640mA	Typ. Luminous Flux $\Phi_v^{[2,3]}$ [lm] @640mA	Typ. Luminous Efficacy [lm/W] @640mA	Part Number
70	6500	600	667	168	S1W0-5050657006-00000000-00002
	5700	650	678	171	S1W0-5050577006-00000000-00002
	5000	650	690	174	S1W0-5050507006-00000000-00002
	4000	650	700	176	S1W0-5050407006-00000000-00002
	3500	600	657	165	S1W0-5050357006-00000000-00002
	3000	600	650	164	S1W0-5050307006-00000000-00002
	2700	550	634	160	S1W0-5050277006-00000000-00002
	2200	500	540	136	S1W0-5050227006-00000000-00002
80	6500	600	620	156	S1W0-5050658006-00000000-00002
	5700	600	630	159	S1W0-5050578006-00000000-00002
	5000	600	635	160	S1W0-5050508006-00000000-00002
	4000	600	635	160	S1W0-5050408006-00000000-00002
	3500	600	615	155	S1W0-5050358006-00000000-00002
	3000	550	610	154	S1W0-5050308006-00000000-00002
	2700	550	595	150	S1W0-5050278006-00000000-00002

Notes :

- (1) Correlated Color Temperature is derived from the CIE 1931 Chromaticity diagram.
CCT $\pm 5\%$ tolerance.
- (2) Seoul Semiconductor maintains a tolerance of $\pm 7\%$ on flux and power measurements.
- (3) Φ_v is the total luminous flux output as measured with an integrating sphere.
- (4) Tolerance is ± 2.0 on CRI, ± 0.2 on VF measurements.

Product Performance & Characterization Guide

Table 3. Characteristics, $I_F=640\text{mA}$, $T_j=25^\circ\text{C}$

Parameter	Symbol	Value			Unit
		Min.	Typ.	Max.	
Forward Voltage	V_F	5.8	-	6.4	V
Luminous Flux	$\Phi_V^{[2]}$	500	-	750	lm
Correlated Color Temperature ^[3]	CCT	2,700	-	7,000	K
CRI ^[4]	Ra	70	-	80	-
		80		90	
Viewing Angle	$2\theta_{1/2}$	-	120	-	deg.
Thermal resistance (J to S) ^[5]	$R\theta_{j-s}$	-	2.0	-	K/W
ESD Sensitivity(HBM)	-	Class 2 JEDEC JS-001-2017			

Table 4. Absolute Maximum Ratings

Parameter	Symbol	Value	Unit
Forward Current	I_F	800	mA
Power Dissipation	P_D	5.0	W
Junction Temperature	T_j	125	$^\circ\text{C}$
Operating Temperature	T_{opr}	-40 ~ + 100	$^\circ\text{C}$
Storage Temperature	T_{stg}	-40 ~ + 100	$^\circ\text{C}$

Notes :

- (1) Seoul Semiconductor maintains a tolerance of $\pm 7\%$ on flux and power measurements.
- (2) Φ_V is the total luminous flux output as measured with an integrating sphere.
- (3) Correlated Color Temperature is derived from the CIE 1931 Chromaticity diagram.
Color coordinate : ± 0.005 , CCT $\pm 5\%$ tolerance.
- (4) Tolerance is ± 2.0 on CRI, ± 0.2 on VF measurements.

- Calculated performance values are for reference only.
- All measurements were made under the standardized environment of Seoul Semiconductor.

Characteristics Graph

Fig 1. Color Spectrum, $T_j=25^{\circ}\text{C}$, $I_F=640\text{mA}$ (CRI70)

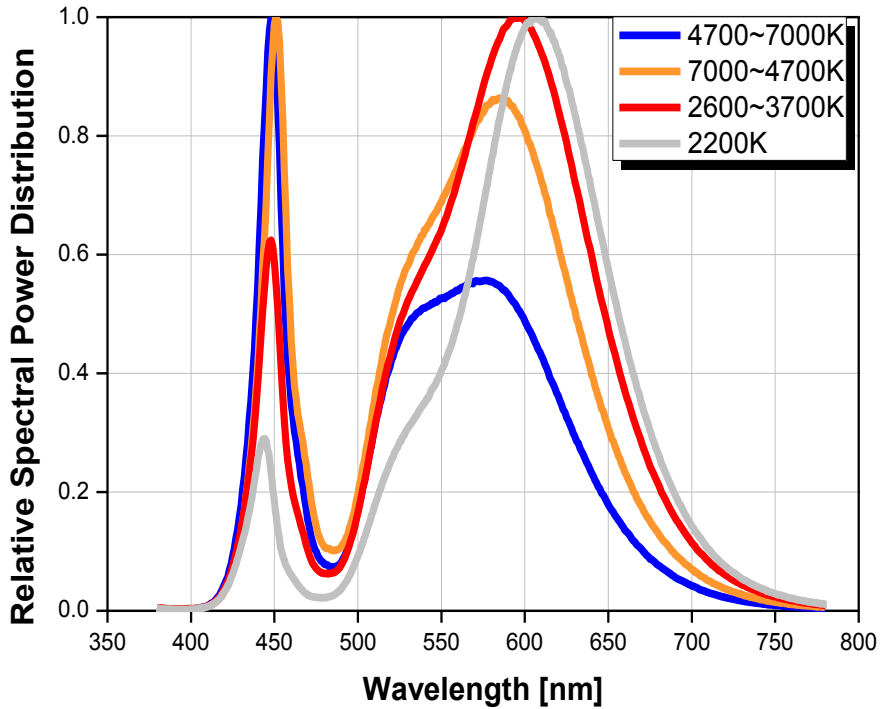
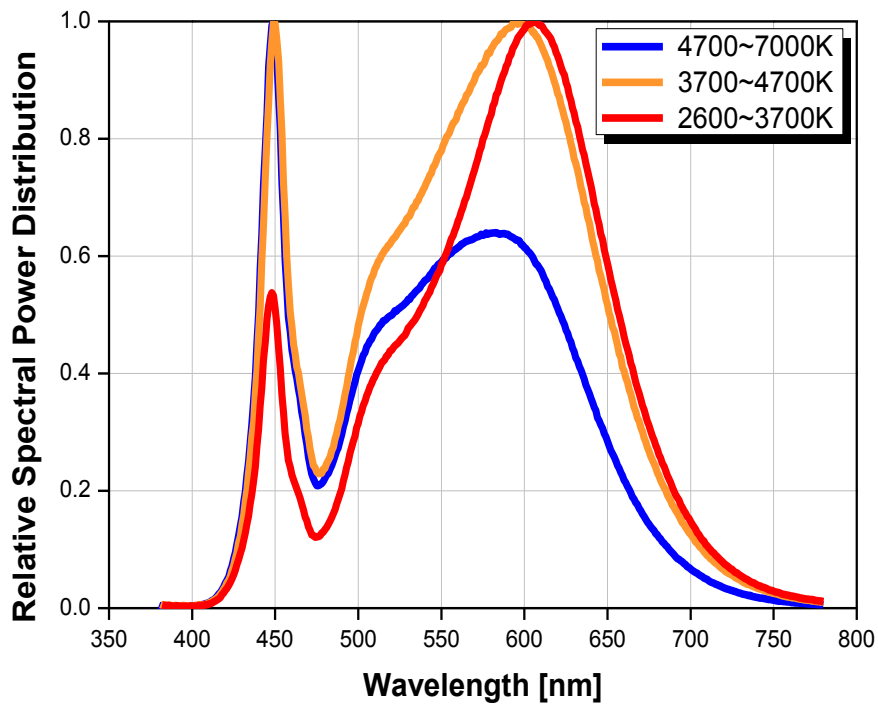
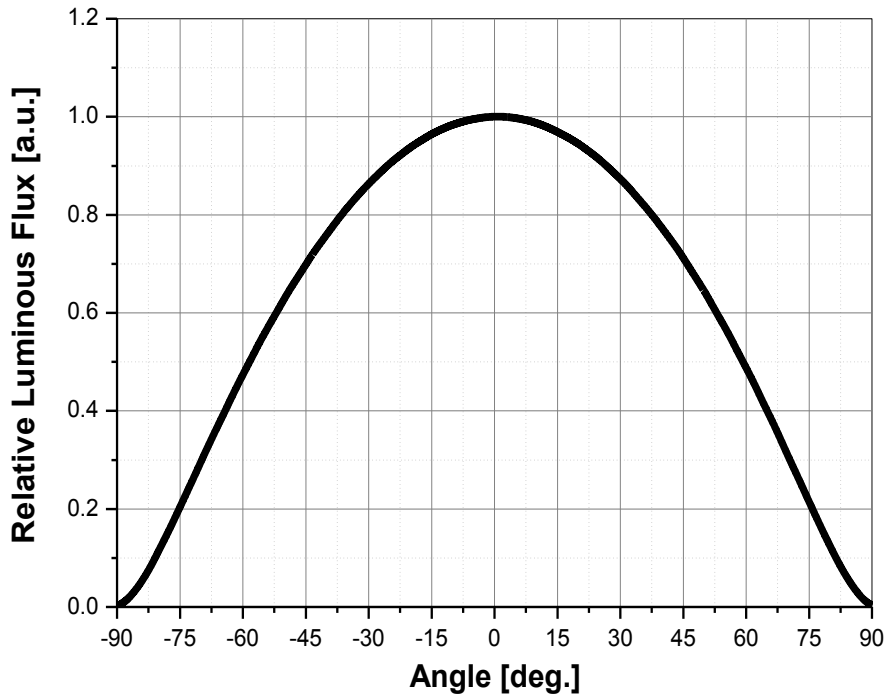

Fig 1. Color Spectrum, $T_j=25^{\circ}\text{C}$, $I_F=640\text{mA}$ (CRI80)



Characteristics Graph

Fig 2. Radiant pattern, $T_j=25^{\circ}\text{C}$, $I_F=640\text{mA}$



Characteristics Graph

Fig 3. Forward Voltage vs. Forward Current, $T_j=25^\circ\text{C}$

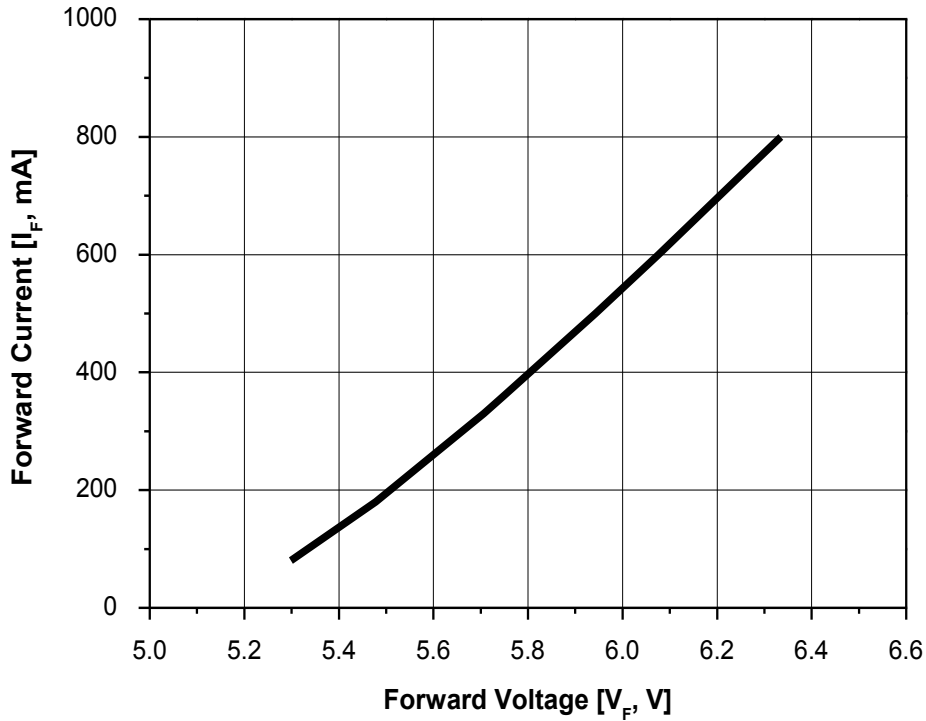
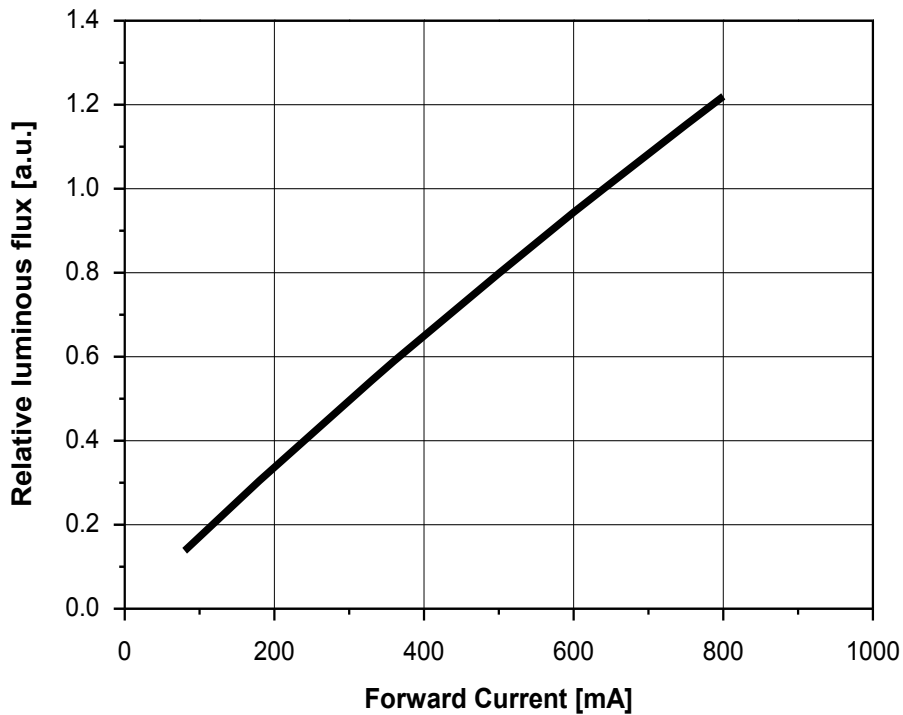
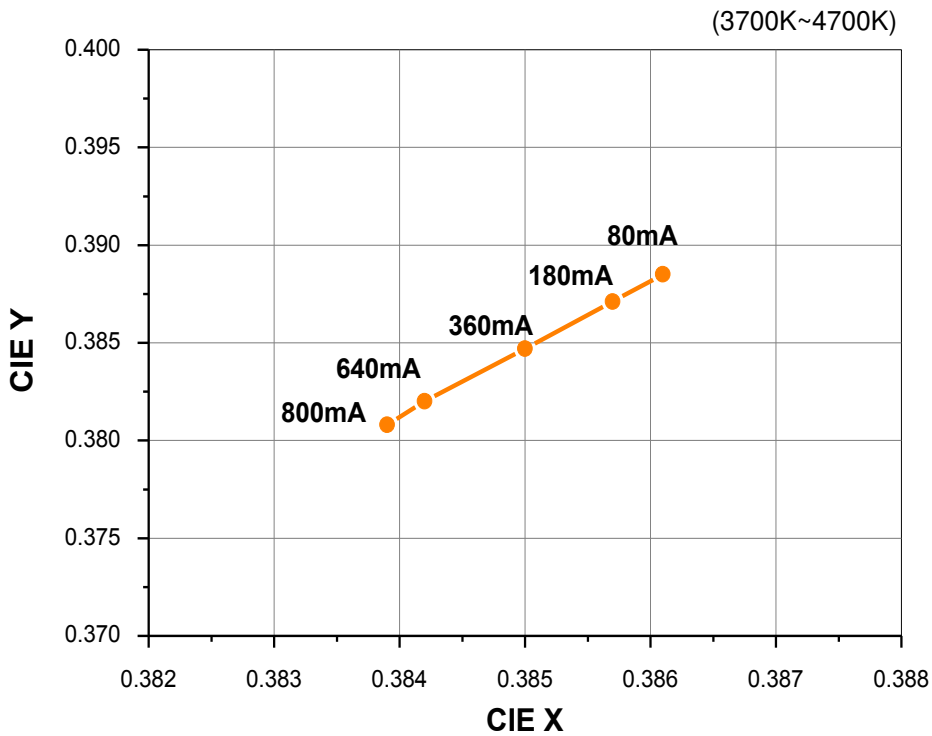
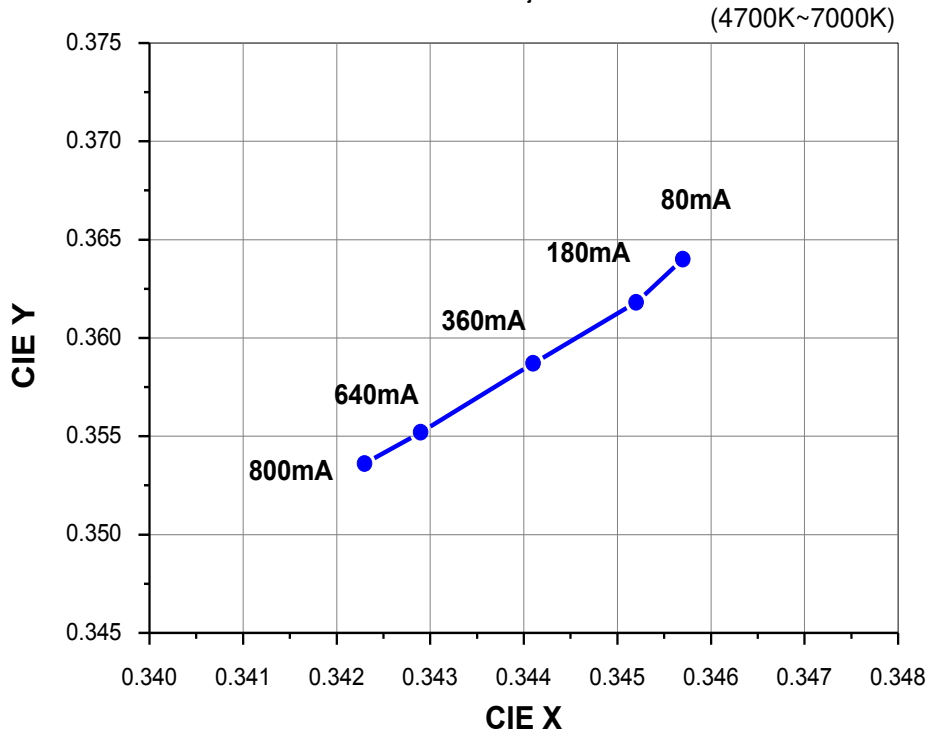

Fig 4. Forward Current vs. Relative Luminous Flux, $T_j=25^\circ\text{C}$



Characteristics Graph

Fig 5. Forward Current vs. CIE X, Y Shift , $T_j=25^{\circ}\text{C}$ (CRI70)



Characteristics Graph

Fig 5. Forward Current vs. CIE X, Y Shift , $T_j=25^{\circ}\text{C}$ (CRI70)

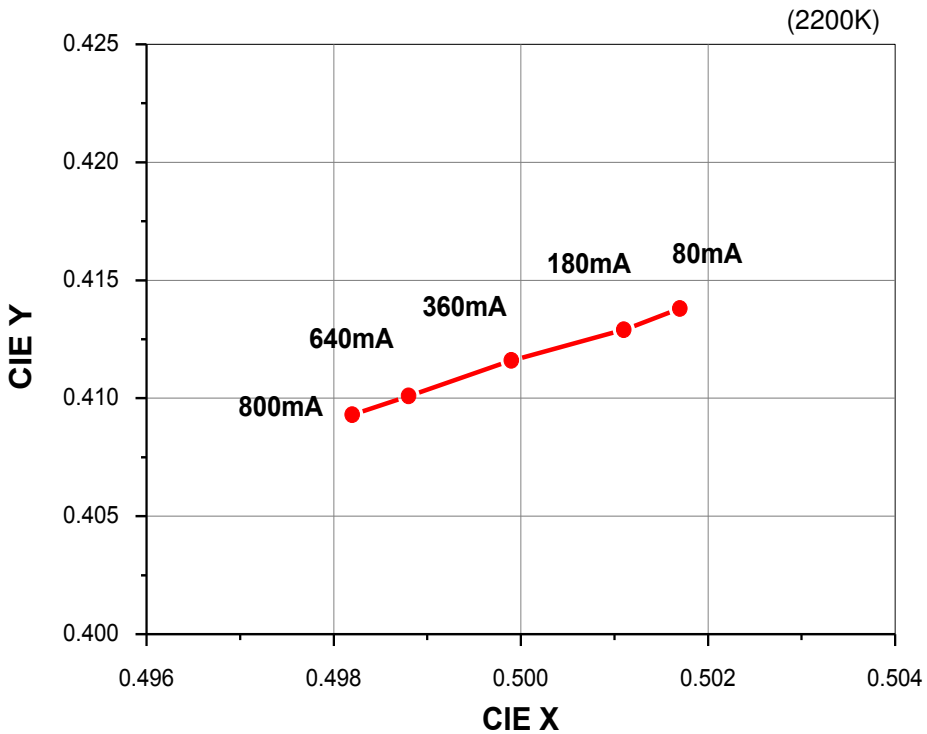
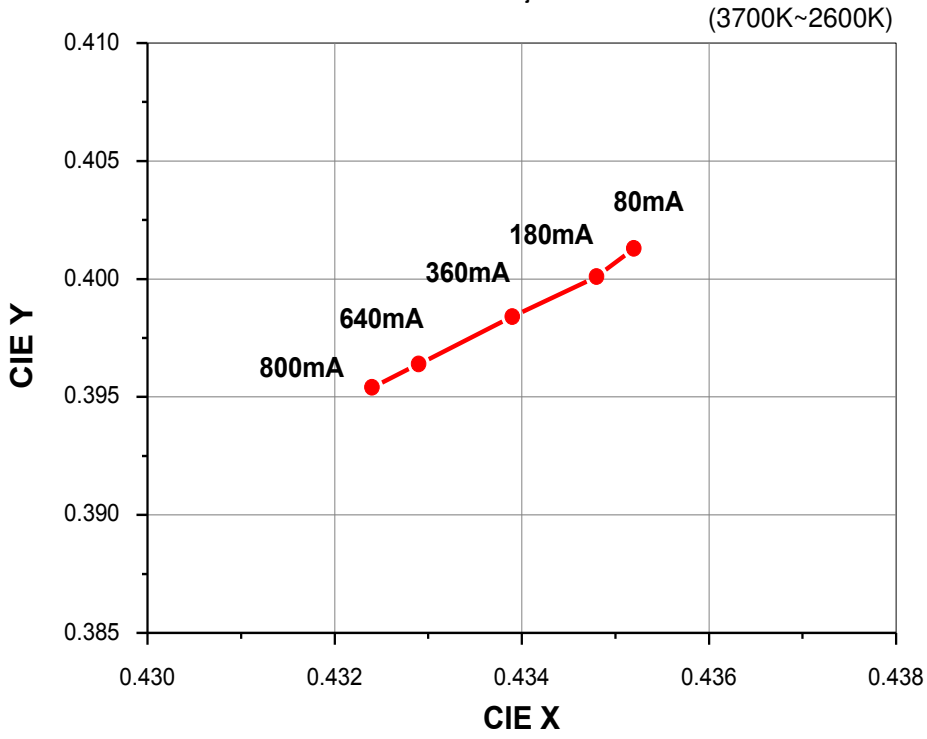

Characteristics Graph

Fig 5. Forward Current vs. CIE X, Y Shift , $T_j=25^{\circ}\text{C}$ (CRI80)

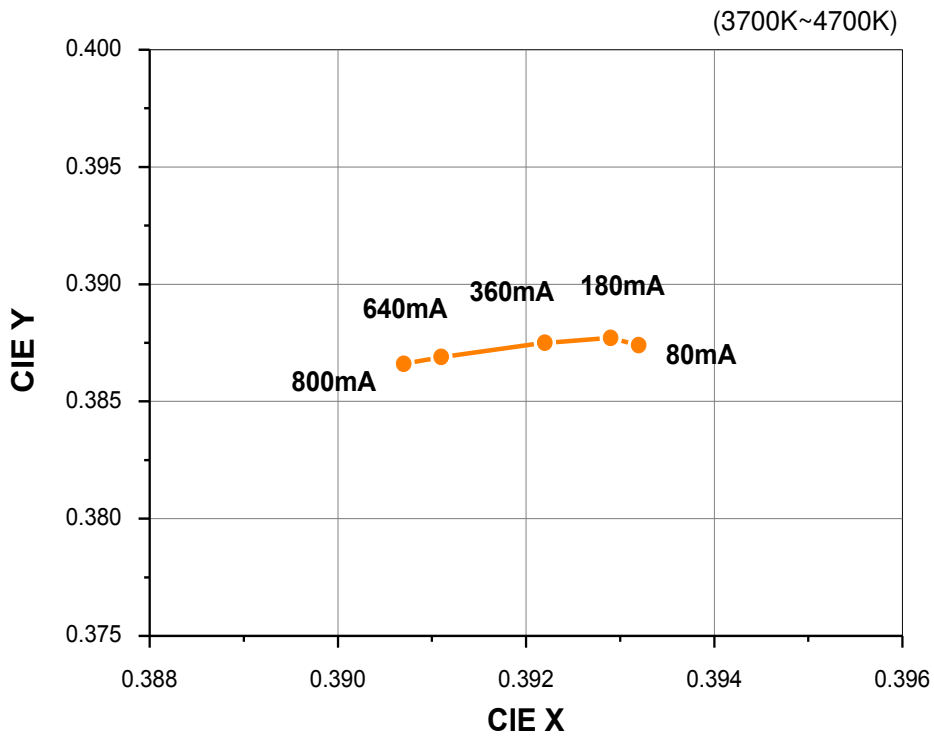
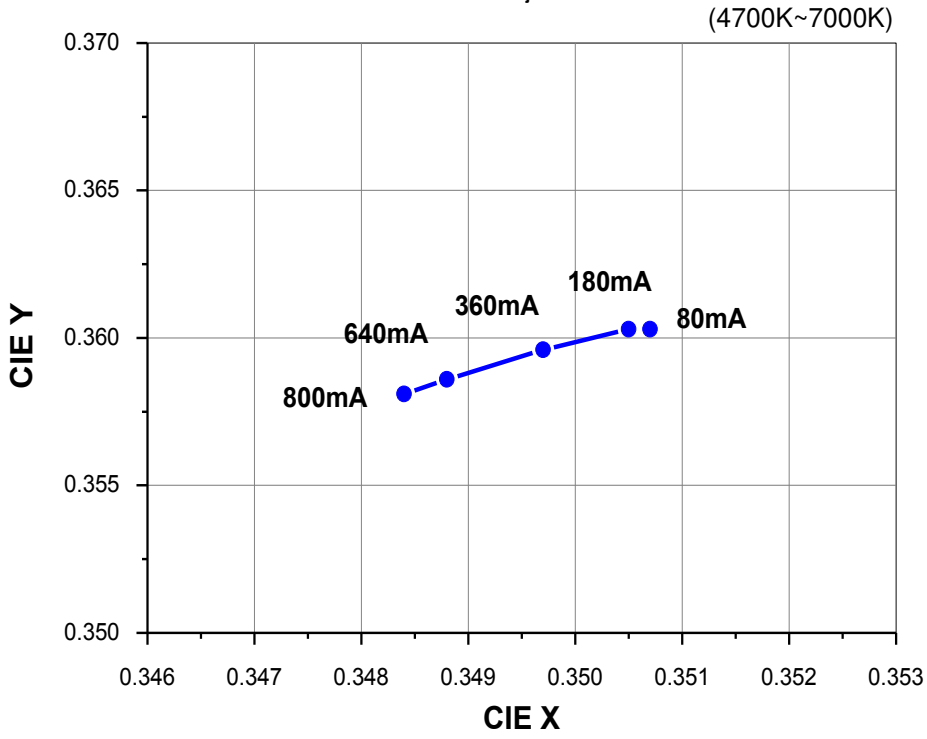

Characteristics Graph

Fig 5. Forward Current vs. CIE X, Y Shift , $T_j=25^{\circ}\text{C}$ (CRI80)

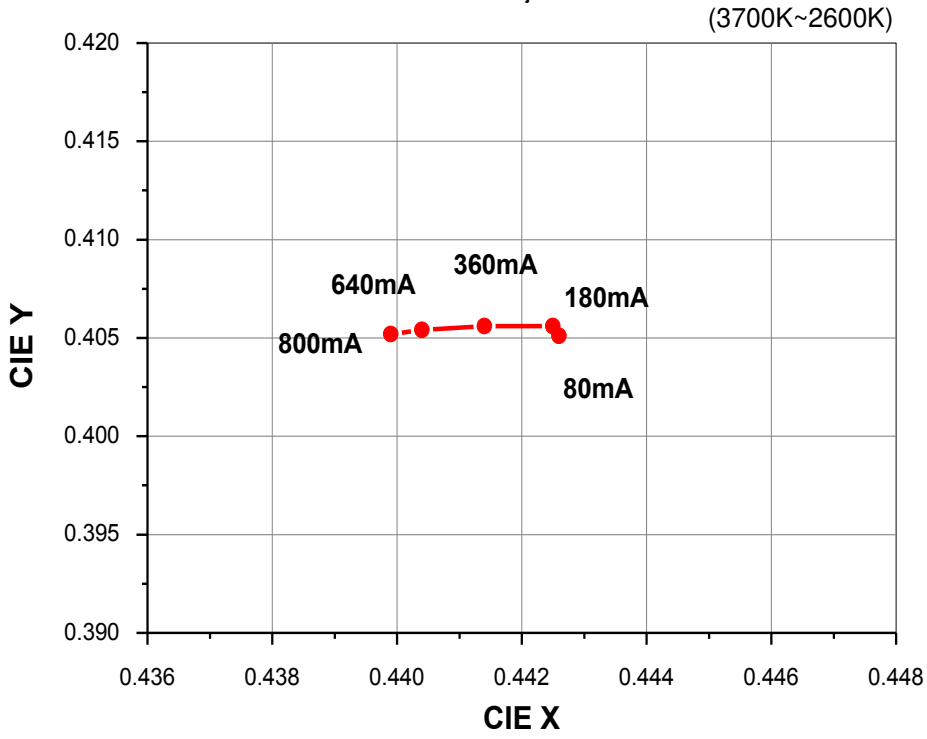

Characteristics Graph

Fig 6. Relative Light Output vs. Junction Temperature, $I_F=640\text{mA}$

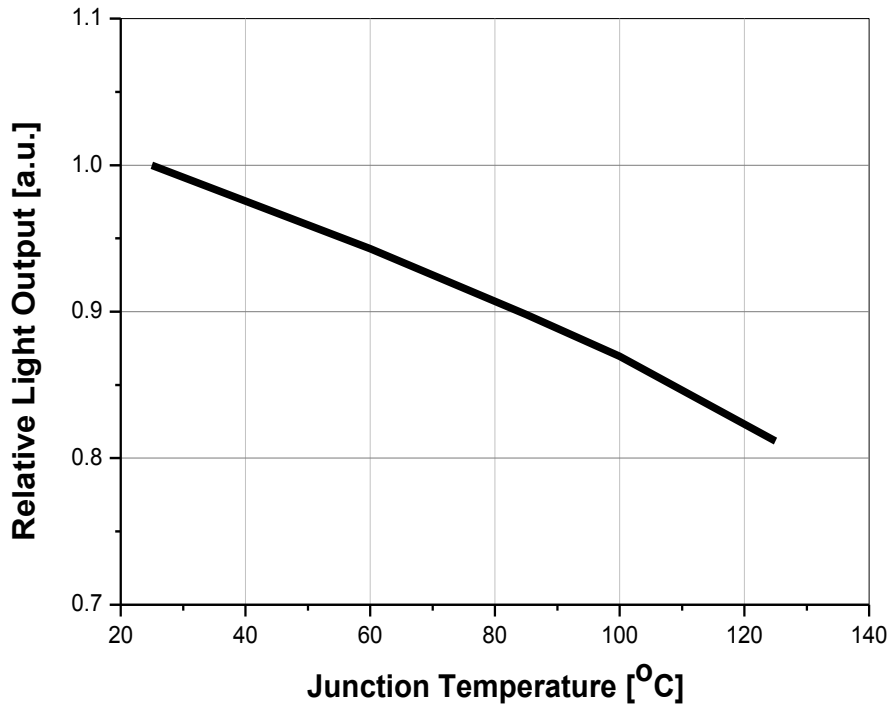
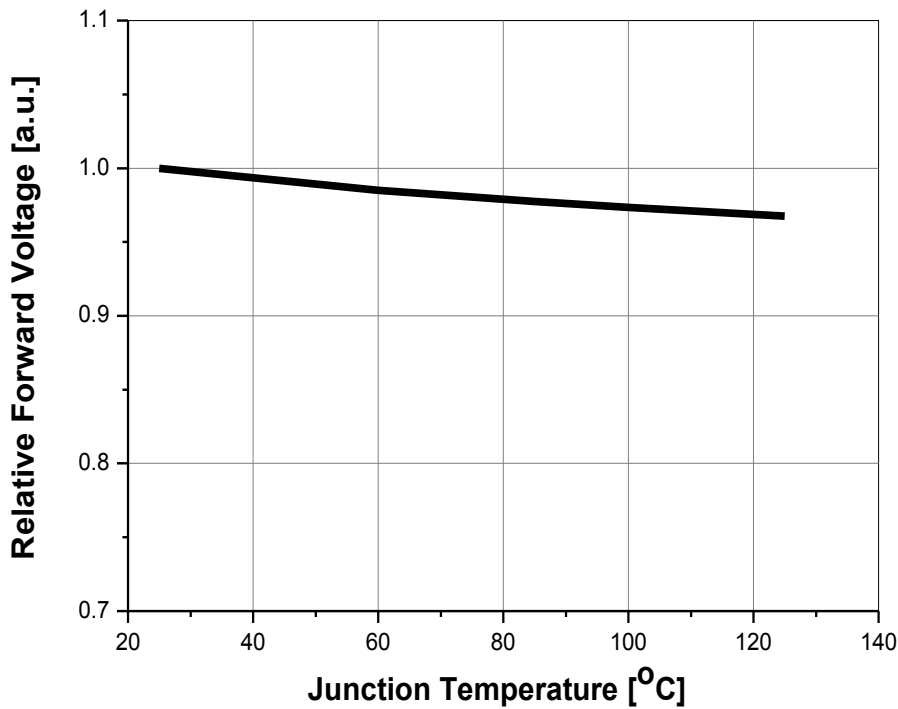
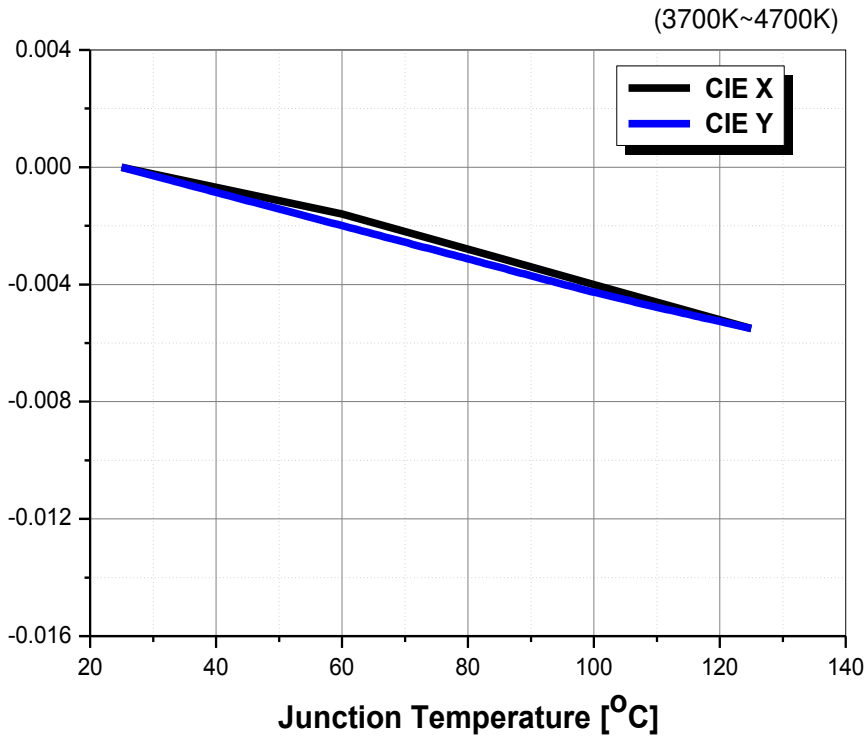
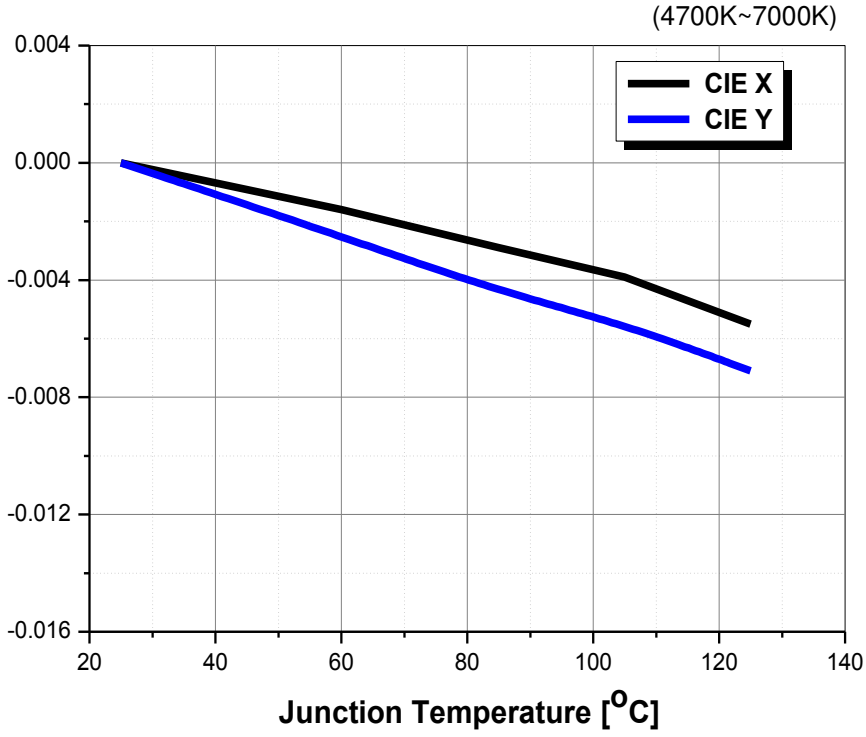

Fig 7. Relative Forward Voltage vs. Junction Temperature, $I_F=640\text{mA}$



Characteristics Graph

Fig 8. Junction Temp. vs. CIE X, Y Shift, $I_F=640\text{mA}$ (CRI70)

Characteristics Graph

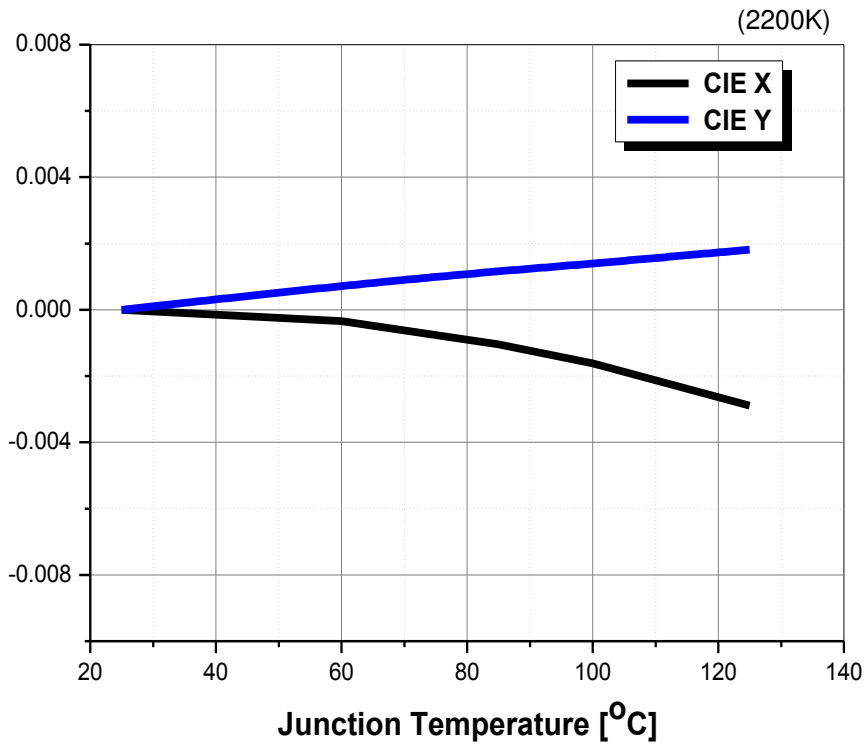
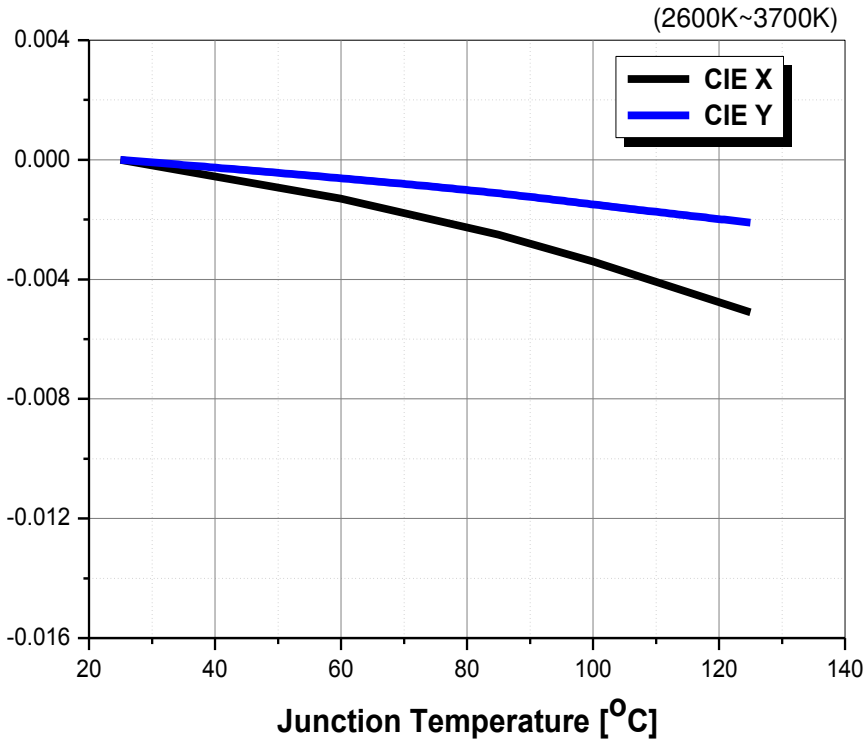
Fig 8. Junction Temp. vs. CIE X, Y Shift, $I_F=640\text{mA}$ (CRI70)

Characteristics Graph

Fig 8. Junction Temp. vs. CIE X, Y Shift, $I_F=640mA$ (CRI80)

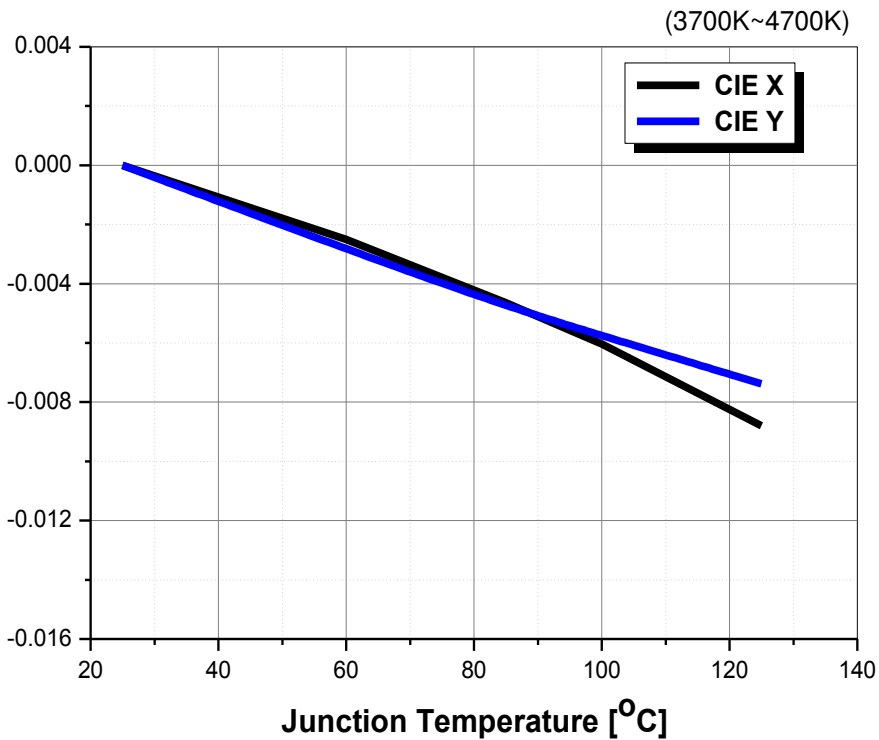
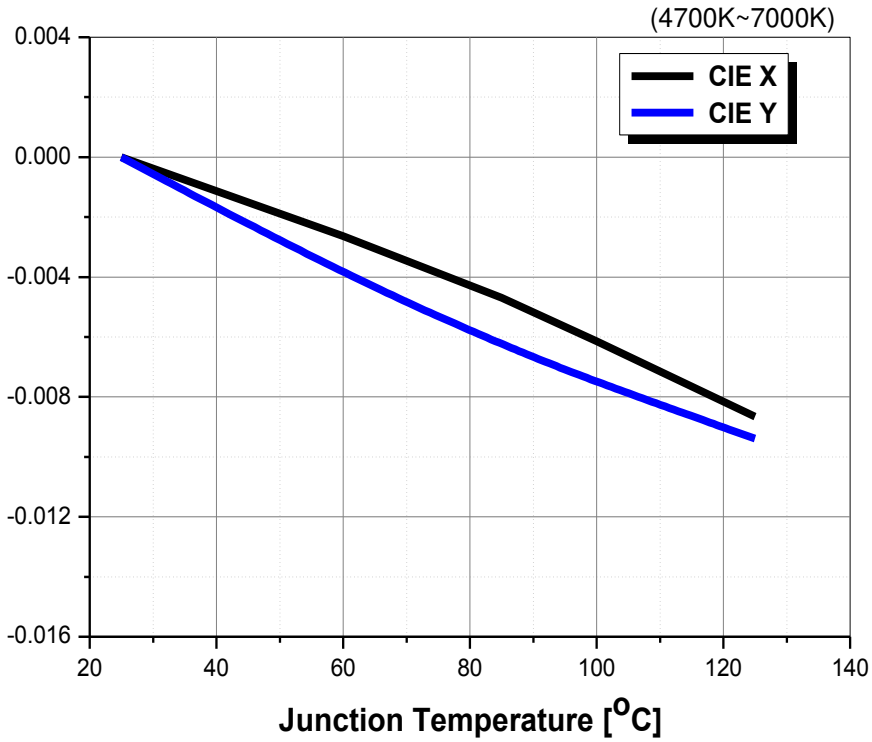

Characteristics Graph

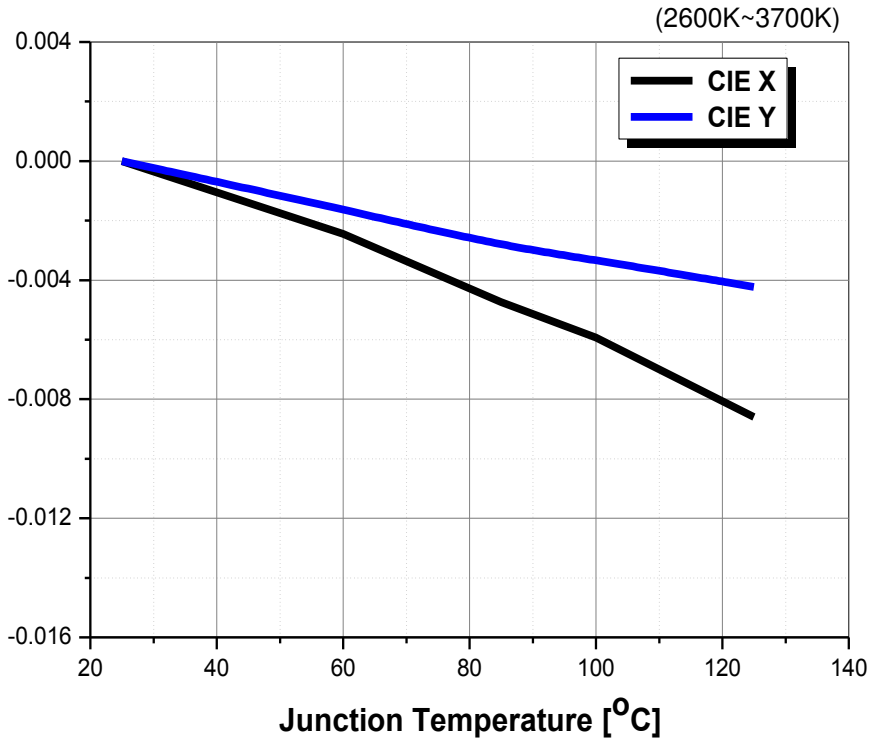
Fig 8. Junction Temp. vs. CIE X, Y Shift, $I_F=640\text{mA}$ (CRI80)

Characteristics Graph

Fig 9. Maximum Forward Current vs. Ambient Temperature, $T_j(\text{max.})=125^\circ\text{C}$, $I_F=800\text{mA}$

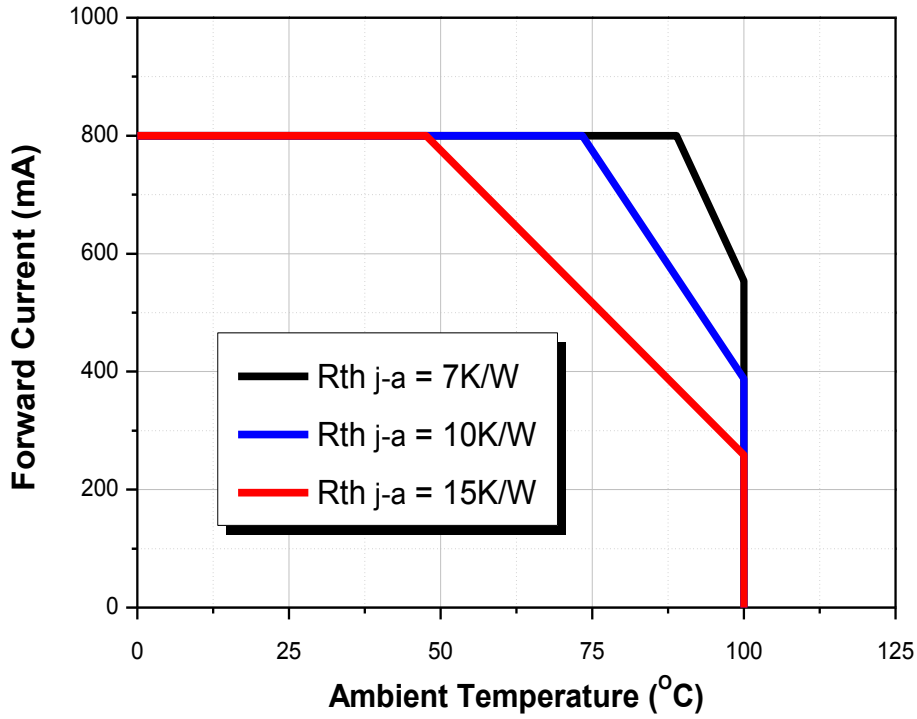

Color Bin Structure

Table 5. Bin Code description

Part Number	Luminous Flux (lm) $I_F=640\text{mA}, T_J=25^\circ\text{C}$			Color Chromaticity Coordinate $I_F=640\text{mA}, T_J=85^\circ\text{C}$	Forward Voltage (V_f) $I_F=640\text{mA}, T_J=25^\circ\text{C}$			CRI
	Bin Code	Min.	Max.		Bin Code	Min.	Max.	
S1W0-5050xxxx06-00000000-00002	V3	500	550	Refer to page. 20 ~ 24	Y8	5.8	6.0	70 80
	W1	550	600		Z0	6.0	6.2	
	W2	600	650		Z2	6.2	6.4	
	W3	650	700					
	W4	700	750					

Table 6. Luminous Flux & Forward Voltage rank distribution

CRI	CCT	CIE	Flux Rank					VF Rank		
70	7000 ~ 6000K	A	V3	W1	W2	W3	W4	Y8	Z0	Z2
	6000 ~ 5300K	B	V3	W1	W2	W3	W4	Y8	Z0	Z2
	5300 ~ 4700K	C	V3	W1	W2	W3	W4	Y8	Z0	Z2
	4200 ~ 3700K	E	V3	W1	W2	W3	W4	Y8	Z0	Z2
	3700 ~ 3200K	F	V3	W1	W2	W3	W4	Y8	Z0	Z2
	3200 ~ 2900K	G	V3	W1	W2	W3	W4	Y8	Z0	Z2
	2900 ~ 2600K	H	V3	W1	W2	W3	W4	Y8	Z0	Z2
	2600 ~ 2200K	K	V3	W1	W2	W3	W4	Y8	Z0	Z2
80	7000 ~ 6000K	A	V3	W1	W2	W3	W4	Y8	Z0	Z2
	6000 ~ 5300K	B	V3	W1	W2	W3	W4	Y8	Z0	Z2
	5300 ~ 4700K	C	V3	W1	W2	W3	W4	Y8	Z0	Z2
	4200 ~ 3700K	E	V3	W1	W2	W3	W4	Y8	Z0	Z2
	3700 ~ 3200K	F	V3	W1	W2	W3	W4	Y8	Z0	Z2
	3200 ~ 2900K	G	V3	W1	W2	W3	W4	Y8	Z0	Z2
	2900 ~ 2600K	H	V3	W1	W2	W3	W4	Y8	Z0	Z2



Available ranks
Not yet available ranks

- All measurements were made under the standardized environment of Seoul Semiconductor.

Color Bin Structure

CIE Chromaticity Diagram $T_j=85^\circ\text{C}$, $I_f=640\text{mA}$

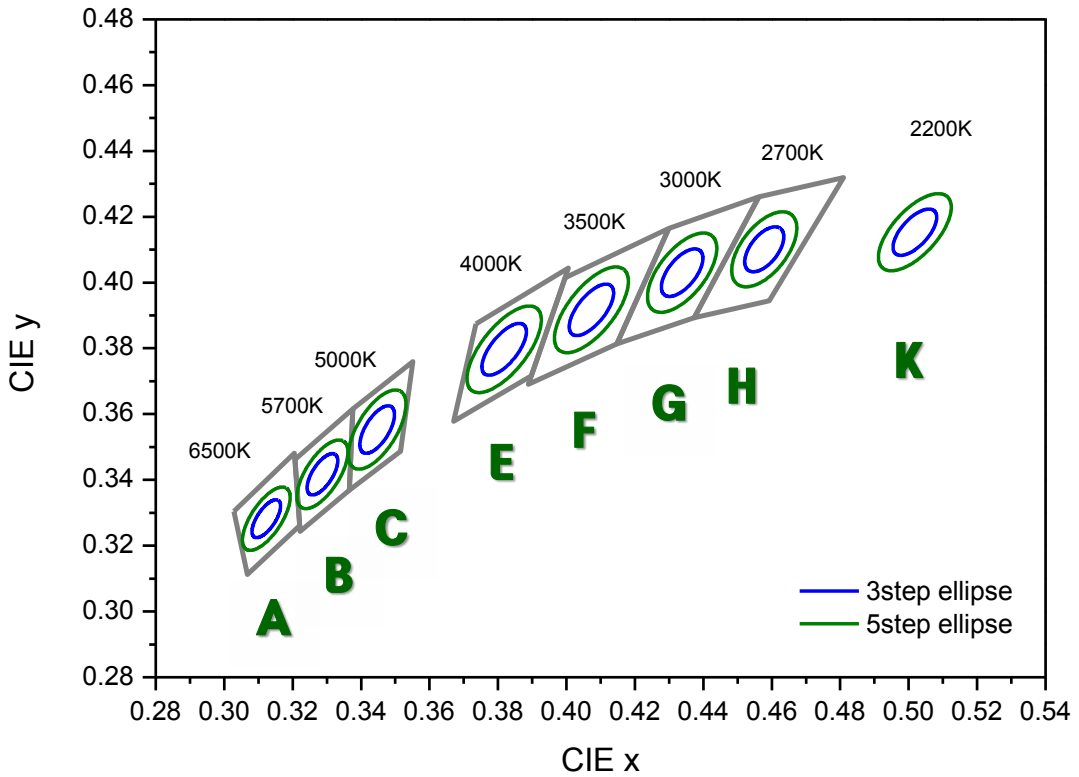

***Notes :**

- Energy Star binning applied to all 2600~7000K.
- Measurement Uncertainty of the Color Coordinates : ± 0.005

Color Bin Structure

CIE Chromaticity Diagram (Cool white), $T_j=85^\circ\text{C}$, $I_F=640\text{mA}$

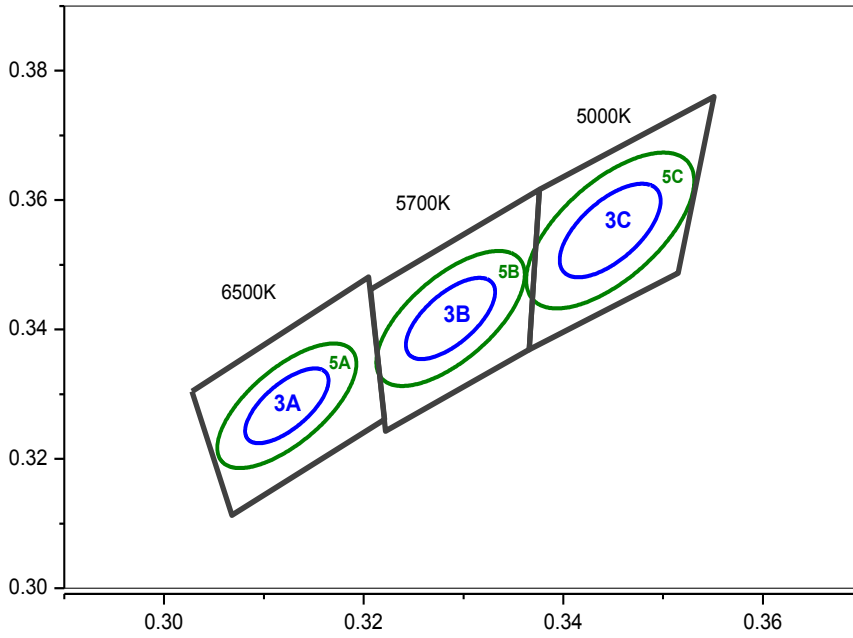

6500K 3Step		5700K 3Step		5000K 3Step	
3A		3B		3C	
Center point	0.3123 : 0.3282	Center point	0.3287 : 0.3417	Center point	0.3447 : 0.3553
Major Axis a	0.0066	Major Axis a	0.0071	Major Axis a	0.0081
Minor Axis b	0.0027	Minor Axis b	0.003	Minor Axis b	0.0035
Ellipse Rotation Angle	58	Ellipse Rotation Angle	59	Ellipse Rotation Angle	60

6500K 5Step		5700K 5Step		5000K 5Step	
5A		5B		5C	
Center point	0.3123 : 0.3282	Center point	0.3287 : 0.3417	Center point	0.3447 : 0.3553
Major Axis a	0.0110	Major Axis a	0.0118	Major Axis a	0.0135
Minor Axis b	0.0045	Minor Axis b	0.0050	Minor Axis b	0.0058
Ellipse Rotation Angle	58	Ellipse Rotation Angle	59	Ellipse Rotation Angle	60

Color Bin Structure

CIE Chromaticity Diagram (Neutral white), $T_j=85^\circ\text{C}$, $I_F=640\text{mA}$

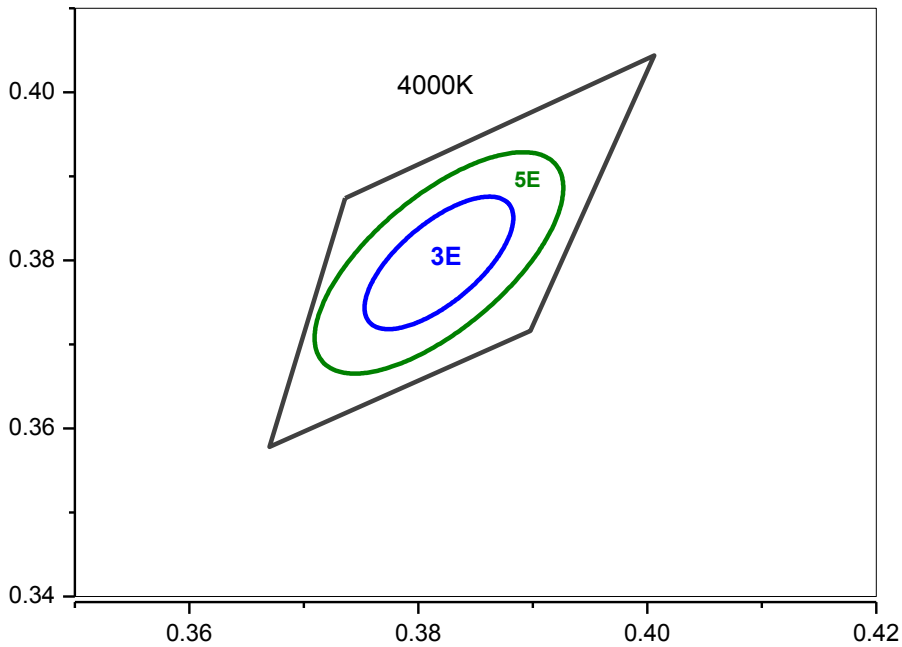

4000K 3Step

3E	
Center point	0.3818 : 0.3797
Major Axis a	0.00940
Minor Axis b	0.00400
Ellipse Rotation Angle	53

4000K 5Step

5E	
Center point	0.3818 : 0.3797
Major Axis a	0.0157
Minor Axis b	0.0067
Ellipse Rotation Angle	53

Color Bin Structure

CIE Chromaticity Diagram (Warm white), $T_j=85^\circ\text{C}$, $I_f=640\text{mA}$

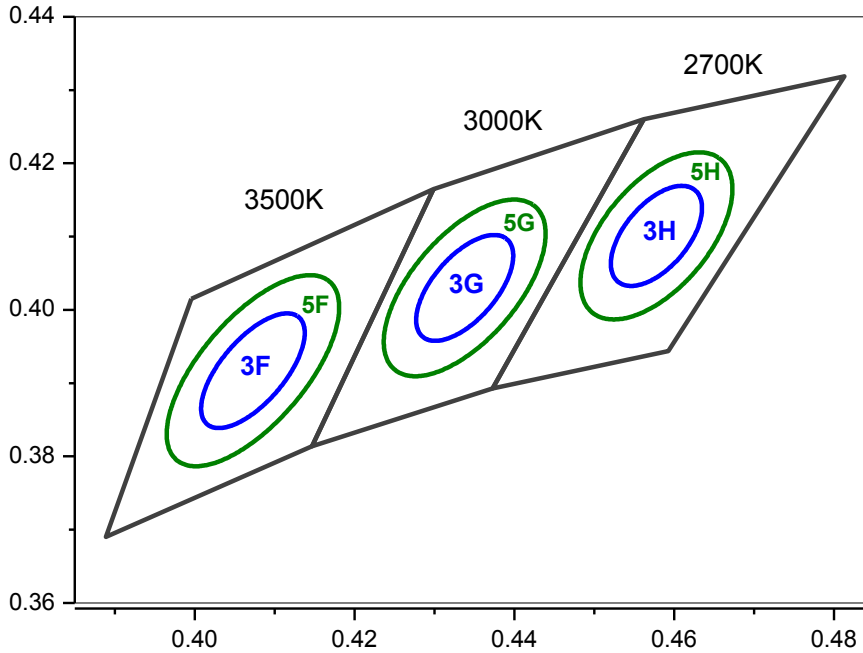

3500K 3Step		3000K 3Step		2700K 3Step	
3F		3G		3H	
Center point	0.4073 : 0.3917	Center point	0.4338 : 0.4030	Center point	0.4578 : 0.4101
Major Axis a	0.0093	Major Axis a	0.0085	Major Axis a	0.0079
Minor Axis b	0.0041	Minor Axis b	0.0041	Minor Axis b	0.0041
Ellipse Rotation Angle	53	Ellipse Rotation Angle	53	Ellipse Rotation Angle	54
3500K 5Step		3000K 5Step		2700K 5Step	
5F		5G		5H	
Center point	0.4073 : 0.3917	Center point	0.4338 : 0.4030	Center point	0.4578 : 0.4101
Major Axis a	0.0155	Major Axis a	0.0142	Major Axis a	0.0132
Minor Axis b	0.0068	Minor Axis b	0.0068	Minor Axis b	0.0068
Ellipse Rotation Angle	53	Ellipse Rotation Angle	53	Ellipse Rotation Angle	54

Color Bin Structure

CIE Chromaticity Diagram (Warm white), $T_j=85^\circ\text{C}$, $I_F=640\text{mA}$

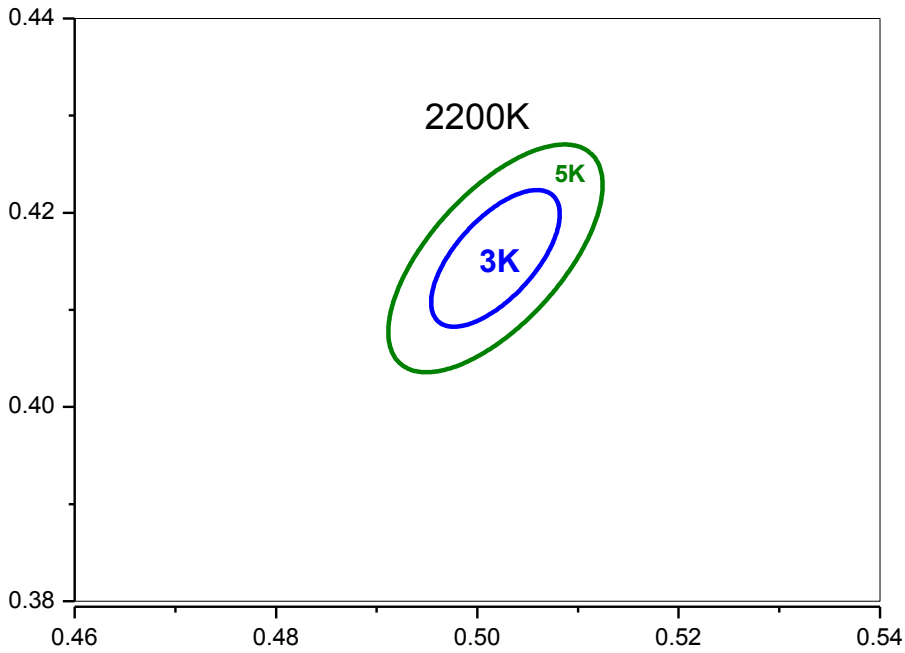

2200K 3Step

3K	
Center point	0.5018 : 0.4153
Major Axis a	0.00863
Minor Axis b	0.00398
Ellipse Rotation Angle	49

2200K 5Step

5K	
Center point	0.5018 : 0.4153
Major Axis a	0.01438
Minor Axis b	0.00663
Ellipse Rotation Angle	49

Mechanical Dimensions

< Top View >

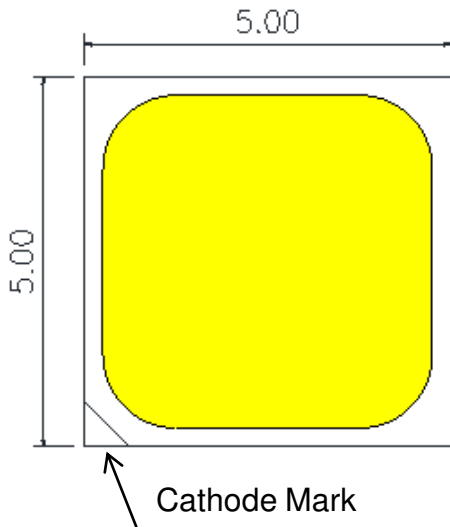

< Bottom View >

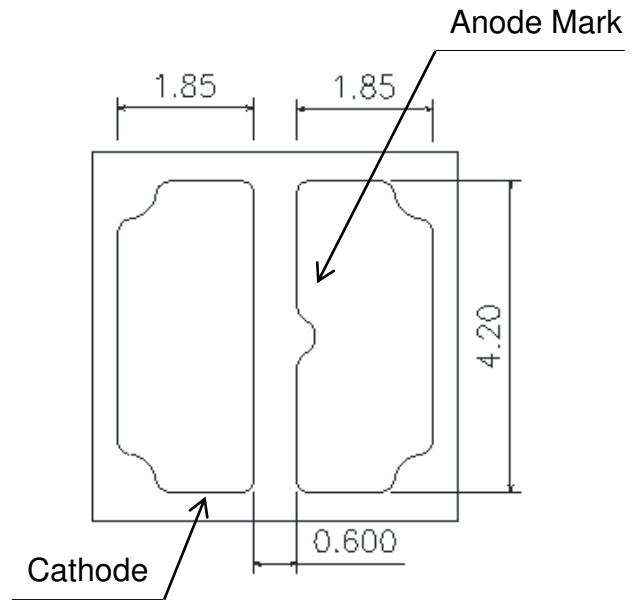

< Side view >



Notes :

- (1) All dimensions are in millimeters.
- (2) Scale : none
- (3) Undefined tolerance is $\pm 0.2\text{mm}$

Recommended Solder Pad

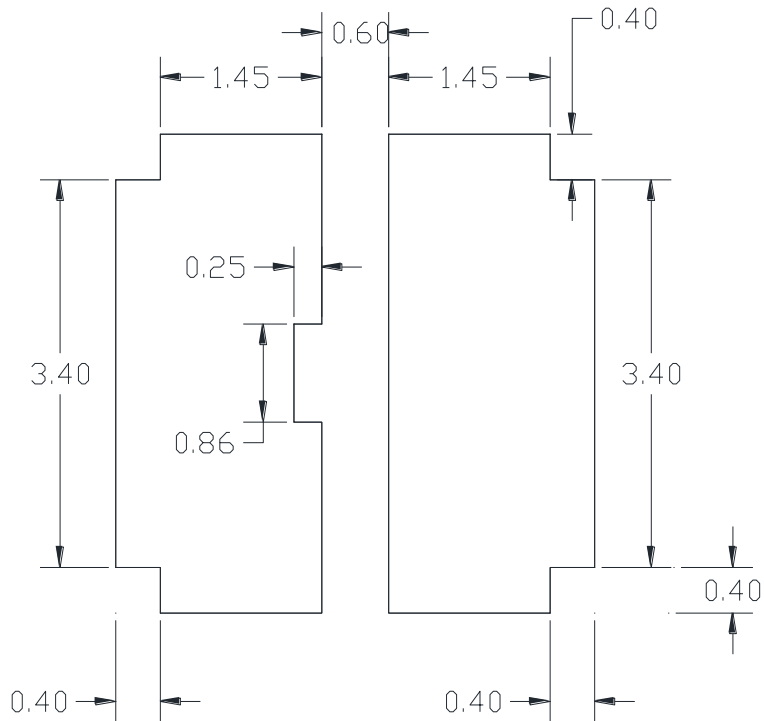

Notes :

- (1) All dimensions are in millimeters.
- (2) Scale : none
- (3) Undefined tolerance is $\pm 0.2\text{mm}$
- (4) This drawing without tolerances are for reference only.

Reflow Soldering Characteristics

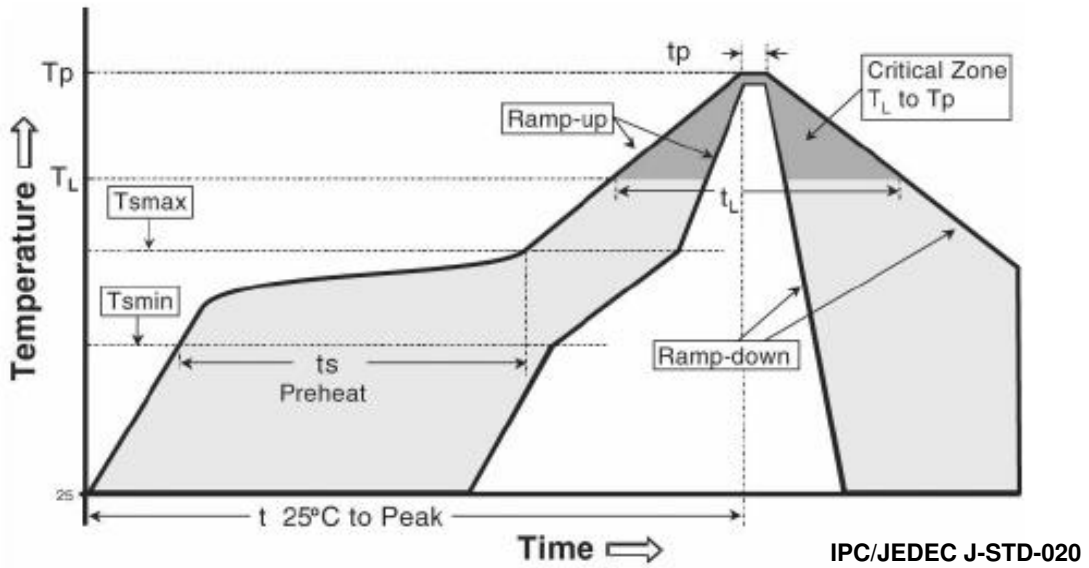
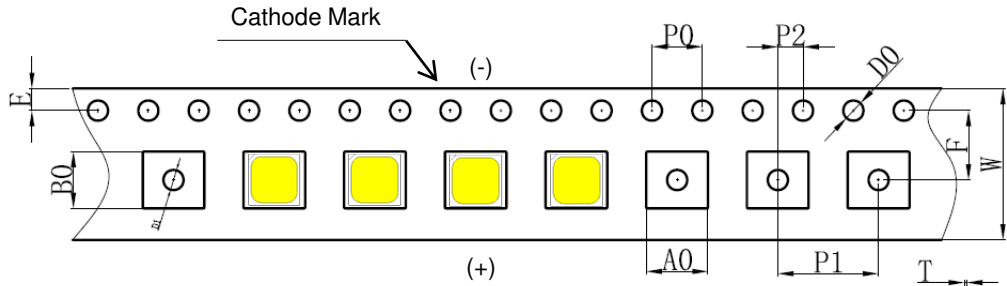

Table 7.

Profile Feature	Sn-Pb Eutectic Assembly	Pb-Free Assembly
Average ramp-up rate (T _{smax} to T _p)	3° C/second max.	3° C/second max.
Preheat - Temperature Min (T _{smin}) - Temperature Max (T _{smax}) - Time (T _{smin} to T _{smax}) (t _s)	100 °C 150 °C 60-120 seconds	150 °C 200 °C 60-180 seconds
Time maintained above: - Temperature (T _L) - Time (t _L)	183 °C 60-150 seconds	217 °C 60-150 seconds
Peak Temperature (T _p)	215°C	260°C
Time within 5°C of actual Peak Temperature (t _p) ²	10-30 seconds	20-40 seconds
Ramp-down Rate	6 °C/second max.	6 °C/second max.
Time 25°C to Peak Temperature	6 minutes max.	8 minutes max.

Caution

- (1) Reflow soldering is recommended not to be done more than two times. In the case of more than 24 hours passed soldering after first, LEDs will be damaged.
- (2) Repairs should not be done after the LEDs have been soldered. When repair is unavoidable, suitable tools must be used.
- (3) Die slug is to be soldered.
- (4) When soldering, do not put stress on the LEDs during heating.
- (5) After soldering, do not warp the circuit board.

Emitter Tape & Reel Packaging

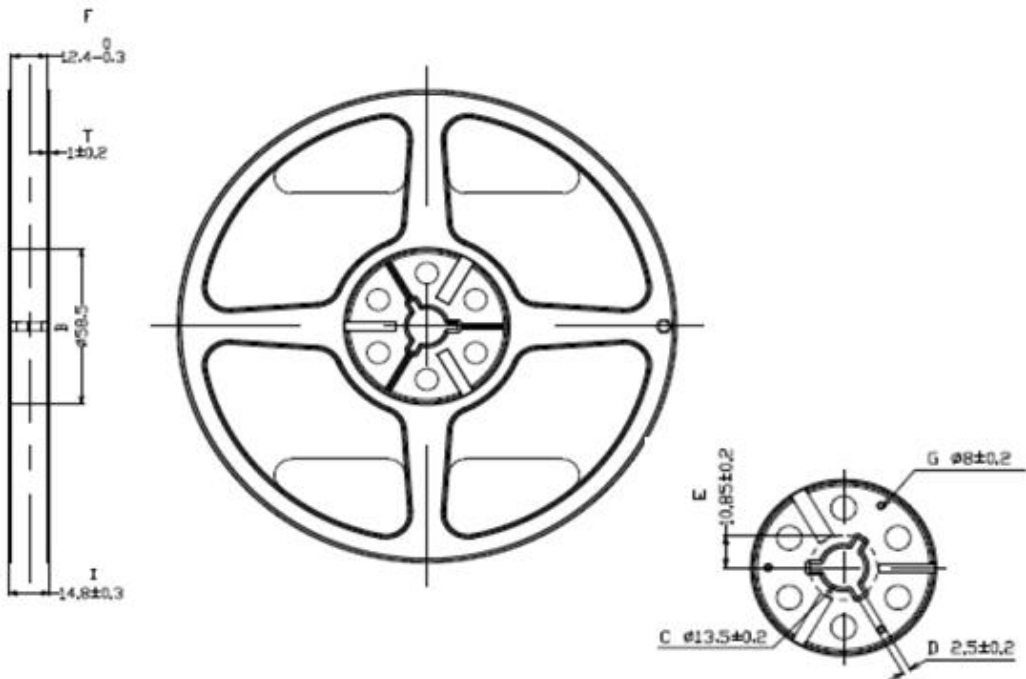
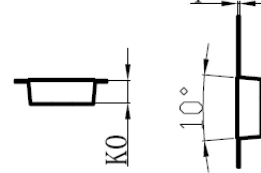

Symbol	W	T	K0	A0	B0	E
Dimension (mm)	12.00 ±0.10	0.30 ±0.30	0.95 ±0.10	5.30 ±0.10	5.30 ±0.10	1.75 ±0.10
Symbol	F	D0	D1	P0	P1	P2
Dimension (mm)	5.50 ±0.10	1.60 ±0.10	1.60 ±0.10	4.00 ±0.10	8.00 ±0.10	2.00 ±0.10

Notes :

- (1) Quantity : 7 inch reel type (1,000 pcs / Reel ± 1pcs)
- (2) Cumulative Tolerance : Cumulative Tolerance/10 pitches to be ±0.2mm
- (3) Adhesion Strength of Cover Tape : Adhesion strength to be 0.1-0.7N when the cover tape is turned off from the carrier tape at the angle of 10° to the carrier tape
- (4) Package : P/N, Manufacturing data Code No. and quantity to be indicated on a damp proof Package.

Emitter Tape & Reel Packaging

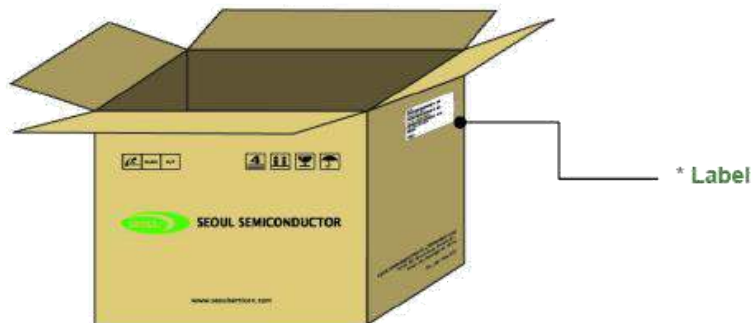
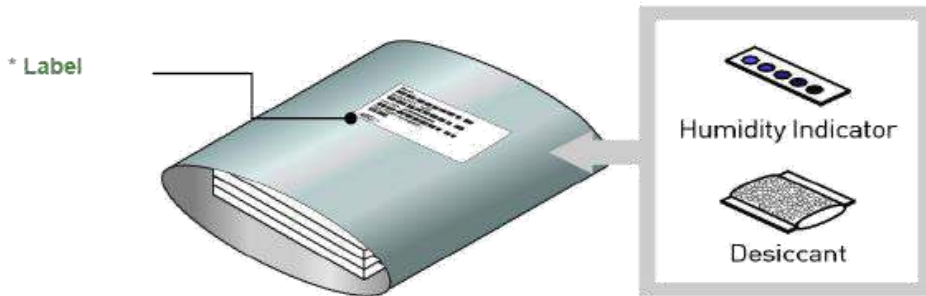
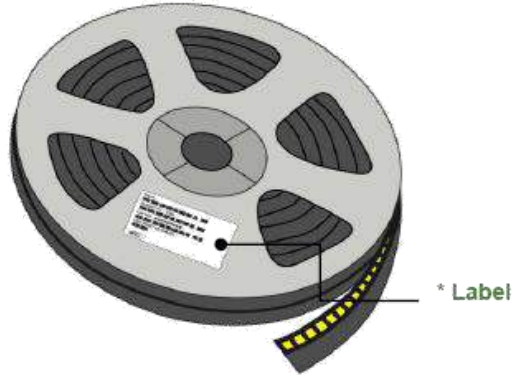

Product Nomenclature

Table 8. Part Numbering System

Part Number Code	Description	Part Number	Value
X ₁	Company	S	Seoul Semiconductor
X ₂	Level of Integration	1	Discrete LED
X ₃ X ₄	Technology	W0	White General
X ₅ X ₆ X ₇ X ₈	Dimension	5050	5.0x5.0mm
X ₉ X ₁₀	CCT	xx	65: 6500K 57: 5700K 50: 5000K 40: 4000K 35: 3500K 30: 3000K 27: 2700K
X ₁₁ X ₁₂	CRI	xx	CRI70 CRI80
X ₁₃ X ₁₄	Vf	06	
X ₁₅ X ₁₆ X ₁₇	Characteristic code Flux Rank	000	
X ₁₈ X ₁₉ X ₂₀	Characteristic code Vf Rank	000	
X ₂₁ X ₂₂	Characteristic code Color Step	xx	3S: 3step ellipse 5S: 5step ellipse
X ₂₃ X ₂₄	Type	00	
X ₂₅ X ₂₆ X ₂₇	Internal code	002	

Handling of Silicone Resin for LEDs

(1) During processing, mechanical stress on the surface should be minimized as much as possible. Sharp objects of all types should not be used to pierce the sealing compound.

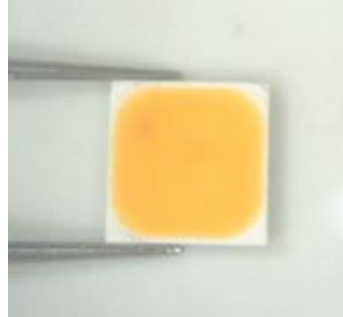

(2) In general, LEDs should only be handled from the side. By the way, this also applies to LEDs without a silicone sealant, since the surface can also become scratched.

(3) When populating boards in SMT production, there are basically no restrictions regarding the form of the pick and place nozzle, except that mechanical pressure on the surface of the resin must be prevented. This is assured by choosing a pick and place nozzle which is larger than the LED's reflector area.

(4) Silicone differs from materials conventionally used for the manufacturing of LEDs. These conditions must be considered during the handling of such devices. Compared to standard encapsulants, silicone is generally softer, and the surface is more likely to attract dust.

As mentioned previously, the increased sensitivity to dust requires special care during processing. In cases where a minimal level of dirt and dust particles cannot be guaranteed, a suitable cleaning solution must be applied to the surface after the soldering of components.

(5) SSC suggests using isopropyl alcohol for cleaning. In case other solvents are used, it must be assured that these solvents do not dissolve the package or resin.

Ultrasonic cleaning is not recommended. Ultrasonic cleaning may cause damage to the LED.

(6) Please do not mold this product into another resin (epoxy, urethane, etc) and do not handle this product with acid or sulfur material in sealed space.

Precaution for Use

(1) Storage

To avoid the moisture penetration, we recommend store in a dry box with a desiccant . The recommended storage temperature range is 5°C to 30°C and a maximum humidity of RH50%.

(2) Use Precaution after Opening the Packaging

Use SMT techniques properly when you solder the LED as separation of the lens may affect the light output efficiency.

Pay attention to the following:

a. Recommend conditions after opening the package

- Sealing / Temperature : 5 ~ 40°C Humidity : less than RH30%

b. If the package has been opened more than 4 week(MSL_2a) or the color of the desiccant changes, components should be dried for 10-12hr at 60±5°C

(3) Do not apply mechanical force or excess vibration during the cooling process to normal temperature after soldering.

(4) Do not rapidly cool device after soldering.

(5) Components should not be mounted on warped (non coplanar) portion of PCB.

(6) Radioactive exposure is not considered for the products listed here in.

(7) Gallium arsenide is used in some of the products listed in this publication. These products are dangerous if they are burned or shredded in the process of disposal. It is also dangerous to drink the liquid or inhale the gas generated by such products when chemically disposed of.

(8) This device should not be used in any type of fluid such as water, oil, organic solvent and etc. When washing is required, IPA (Isopropyl Alcohol) should be used.

(9) When the LEDs are in operation the maximum current should be decided after measuring the package temperature.

(10) LEDs must be stored properly to maintain the device. If the LEDs are stored for 3 months or more after being shipped from Seoul Semiconductor. A sealed container with a nitrogen atmosphere should be used for storage.

(11) The appearance and specifications of the product may be modified for improvement without notice.

(12) Long time exposure of sunlight or occasional UV exposure will cause lens discoloration.

Precaution for Use

(13) VOCs (Volatile organic compounds) emitted from materials used in the construction of fixtures can penetrate silicone encapsulants of LEDs and discolor when exposed to heat and photonic energy. The result can be a significant loss of light output from the fixture. Knowledge of the properties of the materials selected to be used in the construction of fixtures can help prevent these issues.

(14) The slug is electrically isolated.

(15) Attaching LEDs, do not use adhesives that outgas organic vapor.

(16) The driving circuit must be designed to allow forward voltage only when it is ON or OFF. If the reverse voltage is applied to LED, migration can be generated resulting in LED damage.

(17) LEDs are sensitive to Electro-Static Discharge (ESD) and Electrical Over Stress (EOS). Below is a list of suggestions that Seoul Semiconductor purposes to minimize these effects.

a. ESD (Electro Static Discharge)

Electrostatic discharge (ESD) is defined as the release of static electricity when two objects come into contact. While most ESD events are considered harmless, it can be an expensive problem in many industrial environments during production and storage. The damage from ESD to LEDs may cause the product to demonstrate unusual characteristics such as:

- Increase in reverse leakage current lowered turn-on voltage
- Abnormal emissions from the LED at low current

The following recommendations are suggested to help minimize the potential for an ESD event. One or more recommended work area suggestions:

- Ionizing fan setup
- ESD table/shelf mat made of conductive materials
- ESD safe storage containers

One or more personnel suggestion options:

- Antistatic wrist-strap
- Antistatic material shoes
- Antistatic clothes

Environmental controls:

- Humidity control (ESD gets worse in a dry environment)

Precaution for Use

b. EOS (Electrical Over Stress)

Electrical Over-Stress (EOS) is defined as damage that may occur when an electronic device is subjected to a current or voltage that is beyond the maximum specification limits of the device.

The effects from an EOS event can be noticed through product performance like:

- Changes to the performance of the LED package
(If the damage is around the bond pad area and since the package is completely encapsulated the package may turn on but flicker show severe performance degradation.)
- Changes to the light output of the luminaire from component failure
- Components on the board not operating at determined drive power

Failure of performance from entire fixture due to changes in circuit voltage and current across total circuit causing trickle down failures. It is impossible to predict the failure mode of every LED exposed to electrical overstress as the failure modes have been investigated to vary, but there are some common signs that will indicate an EOS event has occurred:

- Damaged may be noticed to the bond wires (appearing similar to a blown fuse)
- Damage to the bond pads located on the emission surface of the LED package
(shadowing can be noticed around the bond pads while viewing through a microscope)
- Anomalies noticed in the encapsulation and phosphor around the bond wires.
- This damage usually appears due to the thermal stress produced during the EOS event.

c. To help minimize the damage from an EOS event Seoul Semiconductor recommends utilizing:

- A surge protection circuit
- An appropriately rated over voltage protection device
- A current limiting device



Company Information

Published by

Seoul Semiconductor © 2013 All Rights Reserved.

Company Information

Seoul Semiconductor (www.SeoulSemicon.com) manufactures and packages a wide selection of light emitting diodes (LEDs) for the automotive, general illumination/lighting, Home appliance, signage and back lighting markets. The company is the world's fifth largest LED supplier, holding more than 10,000 patents globally, while offering a wide range of LED technology and production capacity in areas such as "nPola", "Acrich", the world's first commercially produced AC LED, and "Acrich MJT - Multi-Junction Technology" a proprietary family of high-voltage LEDs.

The company's broad product portfolio includes a wide array of package and device choices such as Acrich and Acirch2, high-brightness LEDs, mid-power LEDs, side-view LEDs, and through-hole type LEDs as well as custom modules, displays, and sensors.

Legal Disclaimer

Information in this document is provided in connection with Seoul Semiconductor products. With respect to any examples or hints given herein, any typical values stated herein and/or any information regarding the application of the device, Seoul Semiconductor hereby disclaims any and all warranties and liabilities of any kind, including without limitation, warranties of non-infringement of intellectual property rights of any third party. The appearance and specifications of the product can be changed to improve the quality and/or performance without notice.