

**PROGRAMMABLE HIGH SENSITIVITY
MICROPOWER OMNIPOLAR HALL-EFFECT SWITCH**
Description

The AH1894 is a high sensitivity micropower magnetic range selectable Omnipolar Hall effect switch IC with internal pull up and pull down capability. Designed for portable and battery powered equipment such as cellular phones and portable PCs to home appliances and industrial applications, the average power consumption is only 8uW at 1.85V. To support portable equipment the AH1894 can operate over the supply range of 1.6V to 3.6V and uses a hibernating clocking system to minimize the power consumption. To minimize PCB space the AH1894 is available in small low profile X1-DFN1216-4 and SOT553 packages.

The output is activated with either a north or south pole of sufficient magnetic field strength. The user can select one of two magnetic sensitivity bands via the BSEL pin without the addition of any external components allowing a flexible but small solution. The band select can be hardwired or be changed on the fly via a logic source such as a micro-controller. When the magnetic flux density (B) is larger than operate point (Bop), the output will be turned on (pulled low) and held until B is lower than release point (Brp).

Features

- Omnipolar Operation (North or South pole)
- Programmable Operate and Release Points
- Supply Voltage of 1.6V to 3.6V
- Micropower Operation
- Chopper Stabilized Design Provides:
 - Superior Temperature Stability
 - Minimal Switch Point Drift
 - Enhanced Immunity to Physical Stress
- No External Pull-up Resistors Required
- Good RF Noise Immunity
- -40°C to +85°C Operating Temperature
- High ESD capability of 8kV (Human Body Model) on V_{DD}, GND and OUTPUT Pins
- Small Low Profile X1-DFN1216-4 and SOT553 Packages
- **Totally Lead-Free & Fully RoHS Compliant (Notes 1 & 2)**
- **Halogen and Antimony Free. "Green" Device (Note 3)**

- Notes:
1. No purposely added lead. Fully EU Directive 2002/95/EC (RoHS) & 2011/65/EU (RoHS 2) compliant.
 2. See http://www.diodes.com/quality/lead_free.html for more information about Diodes Incorporated's definitions of Halogen- and Antimony-free, "Green" and Lead-free.
 3. Halogen- and Antimony-free "Green" products are defined as those which contain <900ppm bromine, <900ppm chlorine (<1500ppm total Br + Cl) and <1000ppm antimony compounds.

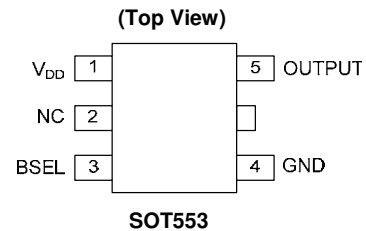
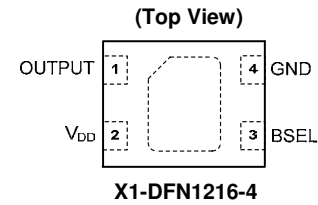
Pin Assignments

Applications

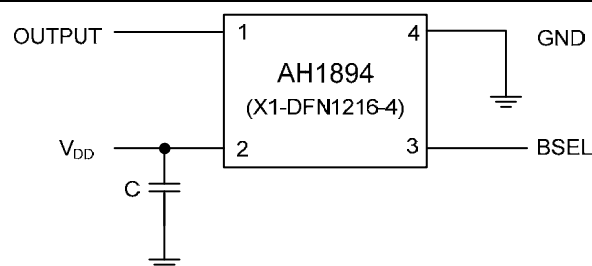
- Open and Close Detect for Cellular Phones
- Holster or cover detect for cellular phones and Tablet PCs
- Cover or Display Switches in Portable PCs
- Digital Still, Video Cameras and Handheld Gaming Consoles
- Door, Lids and Tray Position Switches
- Level, Proximity and Position Switches
- Contact-Less Switches in Home Appliances and Industrial Applications

Typical Applications Circuit

Note: 4. C_{IN} is for power stabilization and to strengthen the noise immunity, the recommended capacitance is 100nF typical.

Pin Descriptions

Package: X1-DFN1216-4

Pin Number	Pin Name	Function
1	OUTPUT	Output Pin
2	V _{DD}	Power Supply Input
3	BSEL	Band Select
4	GND	Ground Pin

Package: SOT553

Pin Number	Pin Name	Function
1	V _{DD}	Power Supply Input
2	NC	No Connection (Note 5)
3	BSEL	Band Select
4	GND	Ground
5	OUTPUT	Output

Note: 5. NC is "No Connection" pin and is not connected internally. This pin can be left open or tied to ground.

Functional Block Diagram

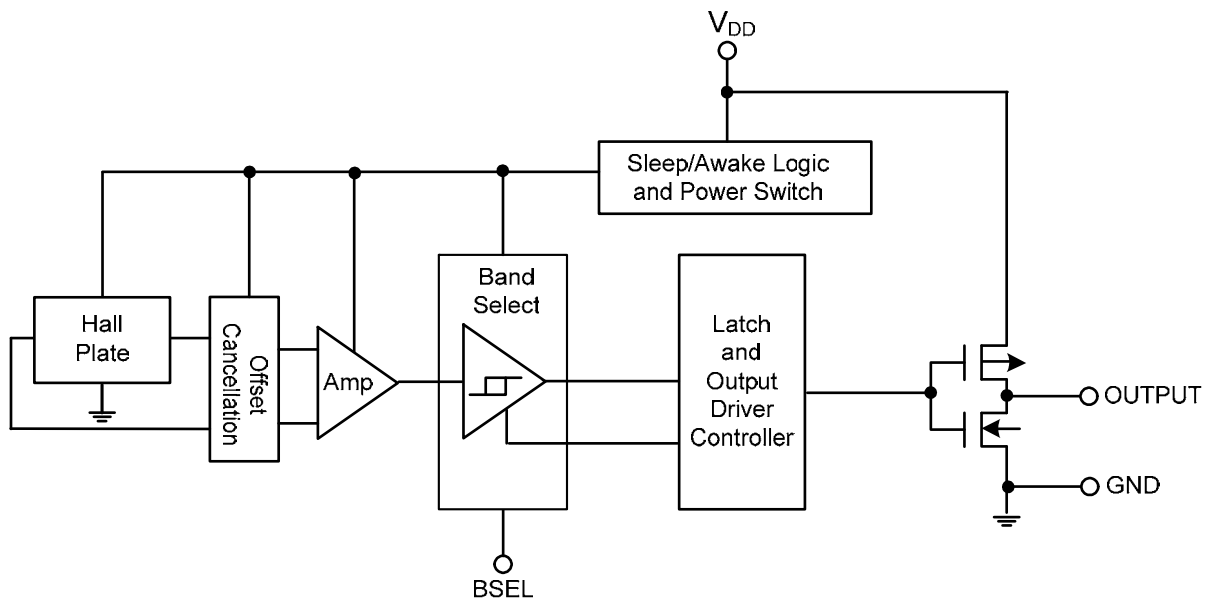

Absolute Maximum Ratings (Note 6) (@ $T_A = +25^\circ\text{C}$, unless otherwise specified.)

Symbol	Parameter	Rating	Unit	
V_{DD}	Supply Voltage (Note 7)	6	V	
V_{DD_REV}	Reverse Supply Voltage	-0.3	V	
I_{OUTPUT}	Output current (source and sink)	3.5	mA	
B	Magnetic Flux Density	Unlimited		
P_D	Package Power Dissipation	X1-DFN1216-4	230	mW
		SOT553	230	mW
T_s	Storage Temperature Range	-65 to +150	$^\circ\text{C}$	
T_J	Maximum Junction Temperature	150	$^\circ\text{C}$	
ESD HBM	Human Body Model (HBM) ESD capability	VDD, GND and OUTPUT pins	8	kV
		BSEL pin	6	kV

- Notes:
- Stresses greater than the 'Absolute Maximum Ratings' specified above may cause permanent damage to the device. These are stress ratings only; functional operation of the device at these or any other conditions exceeding those indicated in this specification is not implied. Device reliability may be affected by exposure to absolute maximum rating conditions for extended periods of time.
 - The absolute maximum V_{DD} of 6V is a transient stress rating and is not meant as a functional operating condition. It is not recommended to operate the device at the absolute maximum rated conditions for any period of time.

Recommended Operating Conditions (@ $T_A = +25^\circ\text{C}$, unless otherwise specified.)

Symbol	Parameter	Conditions	Rating	Unit
V_{DD}	Supply Voltage	Operating	1.6V to 3.6V	V
T_A	Operating Temperature Range	Operating	-40 to +85	$^\circ\text{C}$

Electrical Characteristics (@ $T_A = +25^\circ\text{C}$, $V_{DD} = 1.85\text{V}$, unless otherwise specified.)

Symbol	Parameter	Conditions	Min	Typ	Max	Unit
V_{OL}	Output Low Voltage (on)	$I_{OUT} = 1\text{mA}$	—	0.1	0.2	V
V_{OH}	Output High Voltage (off)	$I_{OUT} = -1\text{mA}$	$V_{DD}-0.2$	$V_{DD}-0.1$	—	V
I_{off}	Output Leakage Current	$V_{OUT} = 3.6\text{V}$, Output off	-	< 0.1	1	μA
V_{SEL_LB}	BSEL pin input voltage – Low Band		0	—	0.5	V
V_{SEL_HB}	BSEL pin input voltage – High Band		1.4	—	3.6	V
R_{PD_BSEL}	BSEL pin internal pull-down resistor	(Note 8)	—	50	—	k Ω
$I_{DD}(\text{awake})$	Supply Current	During 'awake' period, $T_A = +25^\circ\text{C}$, $V_{DD} = 3\text{V}$	—	2.1	—	mA
$I_{DD}(\text{sleep})$		During 'sleep' period, $T_A = +25^\circ\text{C}$, $V_{DD} = 3\text{V}$	—	2.5	—	mA
$I_{DD}(\text{avg})$	Average Supply Current	$T_A = +25^\circ\text{C}$, $V_{DD} = 1.85\text{V}$	—	4.3	8	μA
		$T_A = +25^\circ\text{C}$, $V_{DD} = 3.6\text{V}$	—	7.2	13	μA
T_{awake}	Awake Time	(Note 9)	—	50	100	μs
T_{period}	Period	(Note 9)	—	50	100	ms
D.C.	Duty Cycle	(Note 10)	—	0.1	—	%

- Notes:
- BSEL pin internal pull-down resistor is only active during AWAKE time
 - When power is initially on, the operating V_{DD} (1.6V to 3.6V) must be applied to guarantee the output sampling. The output state is valid after the second operating phase (typical 100ms).
 - Transition time varies dependant on the timing of BSEL activation during the sleep and awake phases.

Electrical Characteristics (cont.)

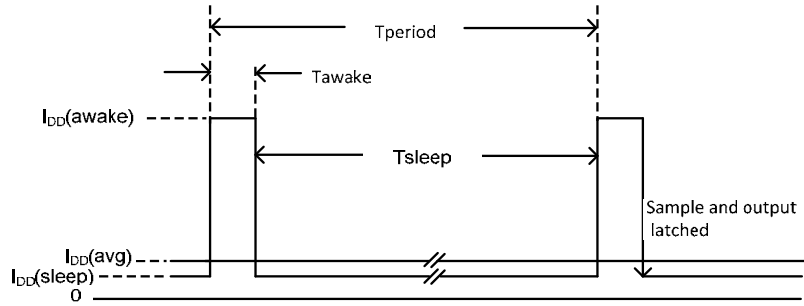

Magnetic Characteristics (Note 11 & 12) ($T_A = -40^{\circ}C$ to $+85^{\circ}C$, $V_{DD} = 1.85V$, unless otherwise specified)

(1mT=10 Gauss)

BSEL	Symbol	Characteristics	Min	Typ	Max	Unit
Low	Bops _{LB} (South pole to part marking side)	Low Band - Operation Point	15	30	45	Gauss
Low	Bopn _{LB} (North pole to part marking side)		-45	-30	-15	
Low	Brps _{LB} (South pole to part marking side)	Low Band - Release Point	10	20	35	
Low	Brpn _{LB} (North pole to part marking side)		-35	-20	-10	
High	Bops _{HB} (South pole to part marking side)	High Band - Operation Point	25	40	55	
High	Bopn _{HB} (North pole to part marking side)		-55	-40	-25	
High	Brps _{HB} (South pole to part marking side)	High Band - Release Point	20	30	45	
High	Brpn _{HB} (North pole to part marking side)		-45	-30	-20	
—	Bhy (Bopx - Brpx)	Hysteresis	—	10	—	

- Notes: 11. Typical data is at $T_A = +25^{\circ}C$, $V_{DD} = 1.85V$.
 12. Maximum and minimum parameters values over the operating temperature range are not tested in production, they are guaranteed by design, process control and characterization. The magnetic characteristics may vary with supply voltage, operating temperature and after soldering.

The AH1894 includes a band select pin (BSEL) so that the operate (Bops and Bopn) and release (Brps and Brpn) points can be adjusted between two pre-defined ranges. The BSEL can be hard wired within the application circuit or the band can be selected on the fly by using the BSEL pin as a logic input. This feature allows the AH1894 sensitivity to be changed by firmware within the application without the addition of any external components. If the BSEL pin is left open circuit the AH1894 defaults to low band.

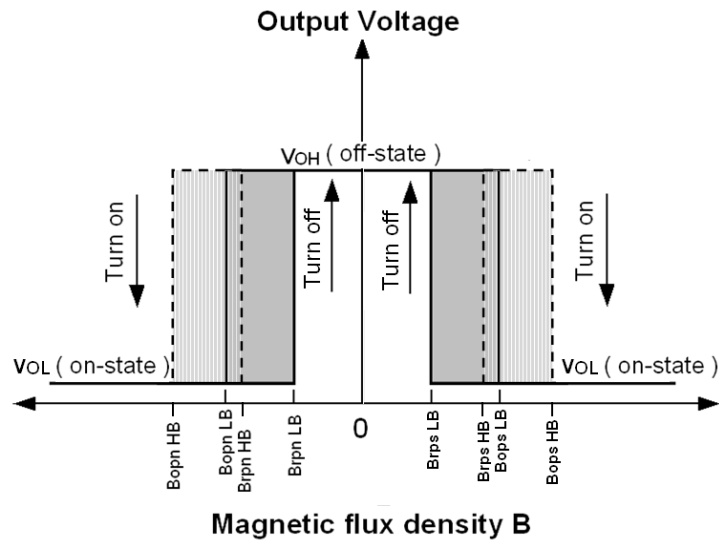

Application Notes

Applications Circuit 1 – Low Band

Leaving the BSEL pin unconnected or connecting the BSEL pin to ground permanently configures the AH1894 into its high sensitivity mode (lower switching thresholds), requiring a reduced magnetic flux density to activate its output (Low Band).

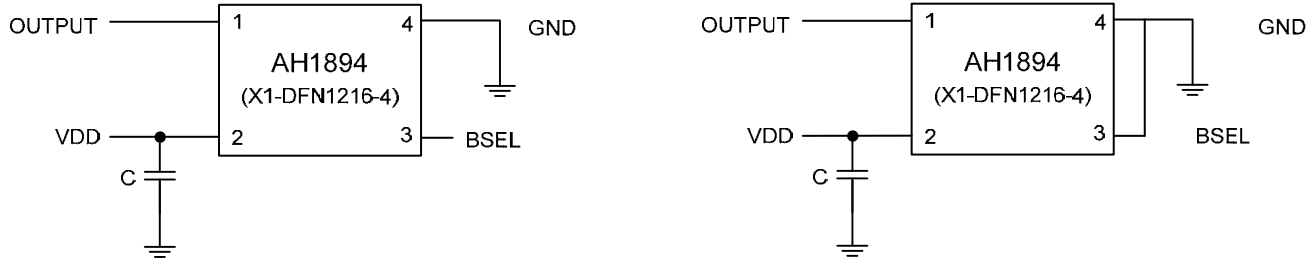

Applications Circuit 2 – High Band

Connecting the BSEL pin to V_{DD} or applying a voltage greater than 1.4V configures the AH1894 into its low sensitivity mode (higher switching threshold), requiring a higher magnetic flux density to activate its output (High Band).

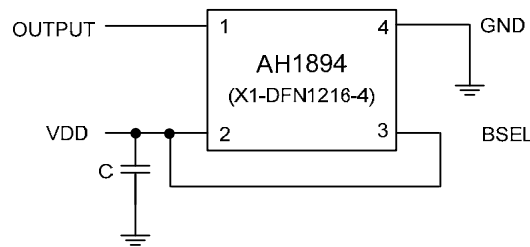

Applications Circuit 3 – Adjustable Sensitivity

To enhance the flexibility within the application the sensitivity can be adjusted with a standard logic signal allowing it to be controlled by a micro-controller or a logic source. This allows the sensitivity to be changed within the application without a hardware change. Whenever the sensitivity band selection is changed, allow for band selection changeover to complete and output to be valid.

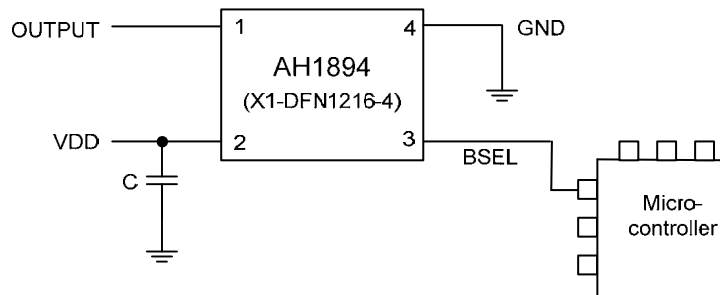

Application Notes (cont.)

Bands Select Change Timing and Valid Output

Whenever band selection BSEL pin input is changed, allow for band selection changeover to complete and stabilize. The output is valid only after the second complete operating 'awake' phase after the band selection change is complete. Time taken for the output to be valid, after the BSEL change, depends on timing of BSEL change during the sleep and awake phase; this time is up to 100ms typical and 200.1ms maximum (TBC).

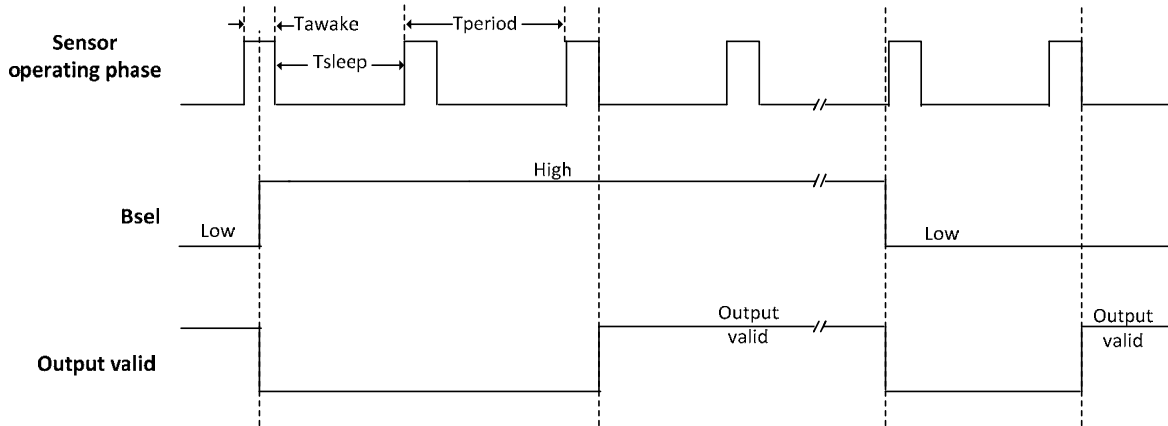

NEW PRODUCT

Typical Operating Characteristics

Typical Switch Points Characteristics in Low Band (BSEL = Low) and High Band (BSEL = High)

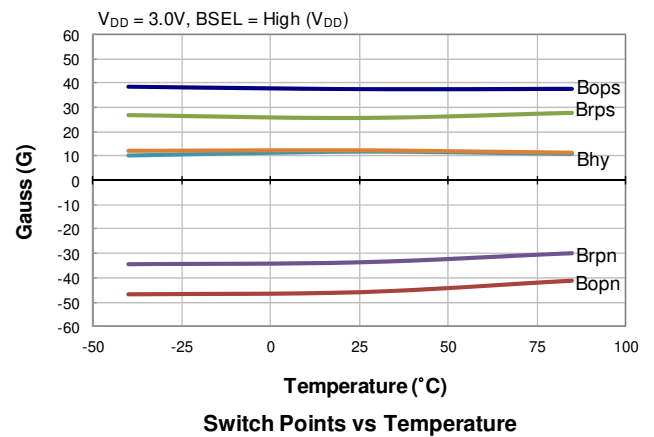
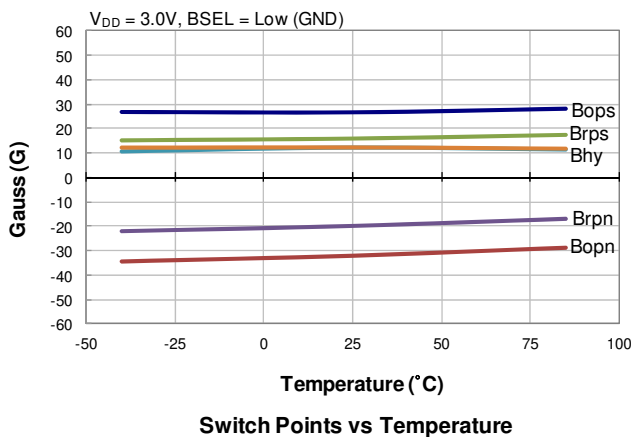
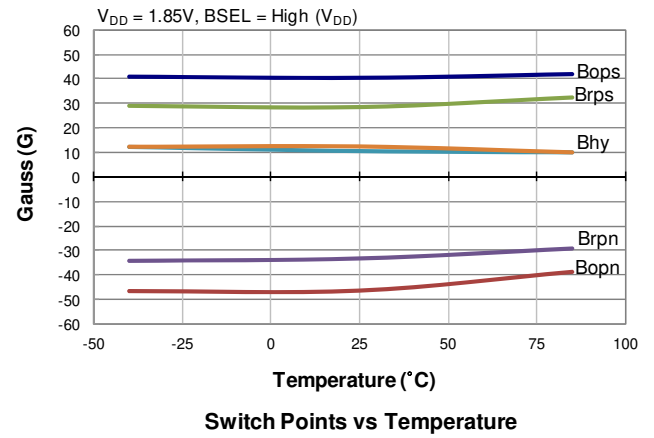
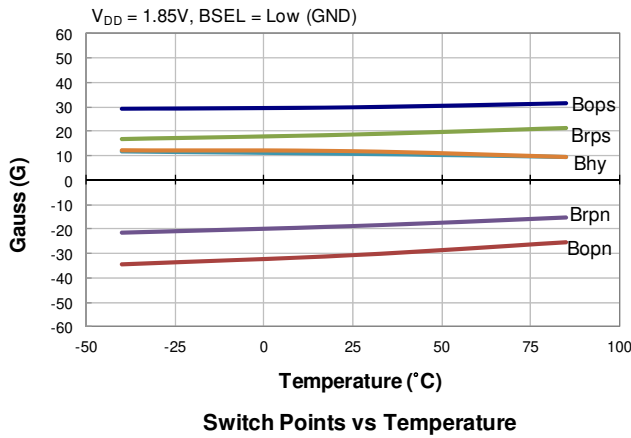
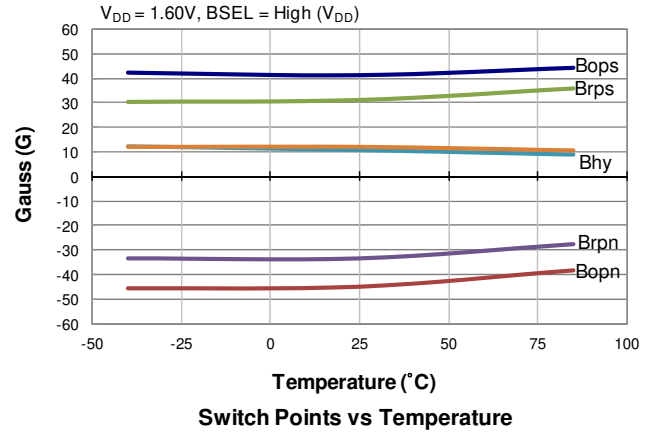
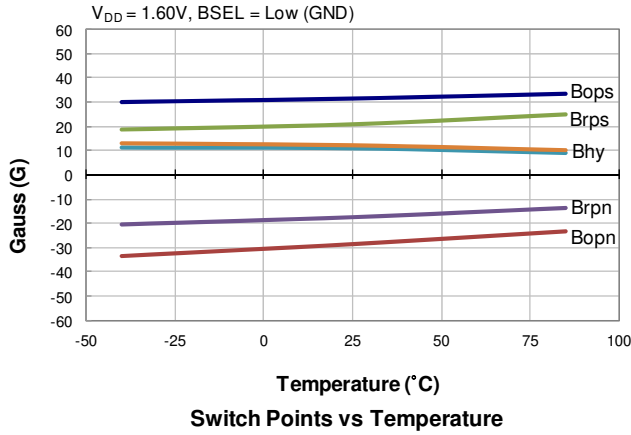

Typical Operating Characteristics (cont.)

Typical Switch Points Characteristics in Low Band (BSEL = Low) and High Band (BSEL = High)

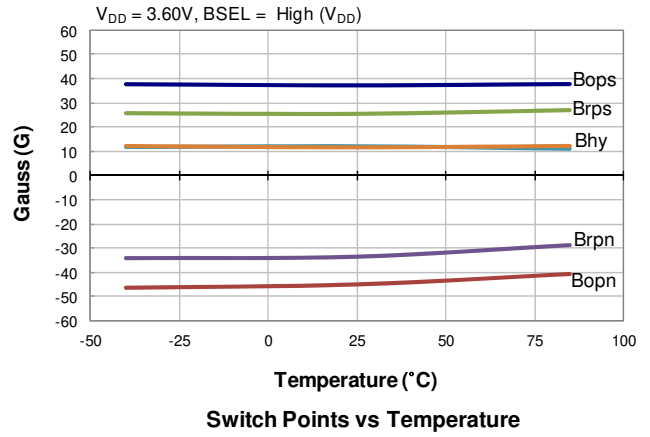
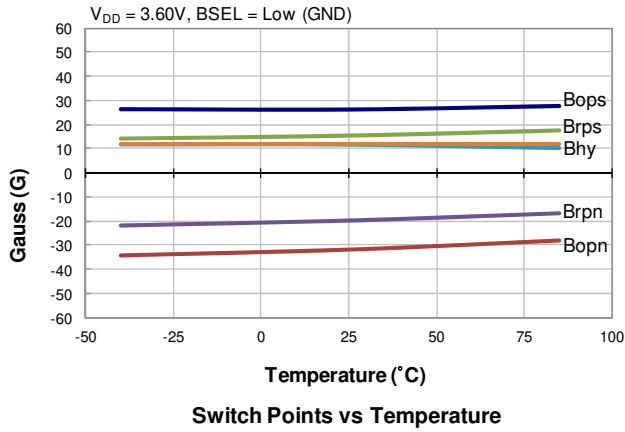

Average Supply Current $I_{DD} (avg)$

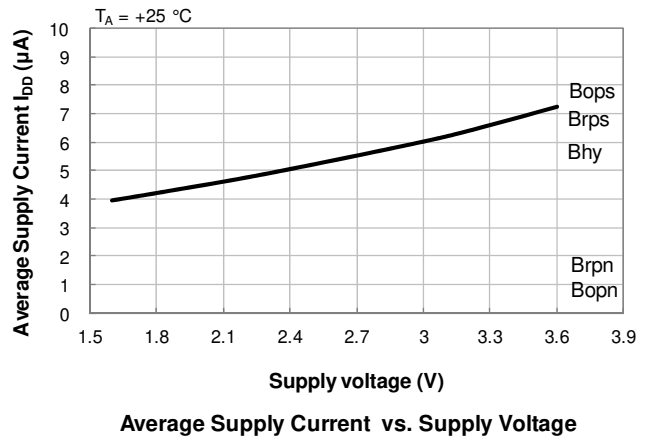
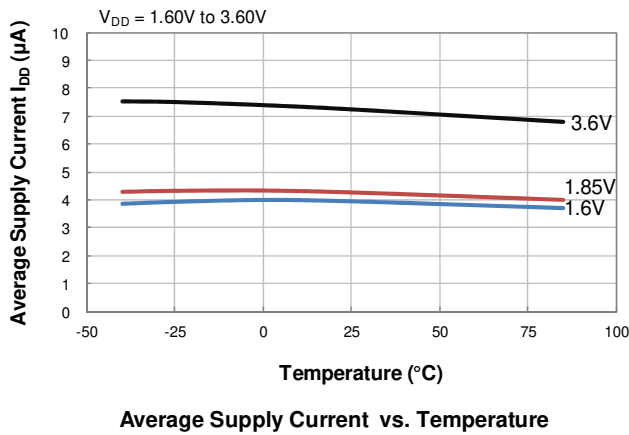

Ordering Information

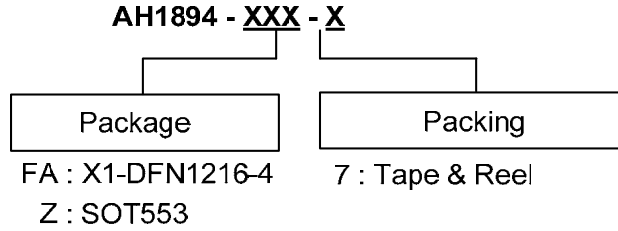

Part Number	Package Code	Packaging	7" Tape and Reel	
			Quantity	Part Number Suffix
AH1894-FA-7	FA	X1-DFN1216-4	3000/Tape & Reel	-7
AH1894-Z-7	Z	SOT553	3000/Tape & Reel	-7

Marking Information

(1) Package Type: X1-DFN1216-4

(Top View)

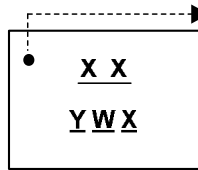

Pin 1 indicator
XX : Identification Code
Y : Year : 0~9
W : Week : A~Z : 1~26 week;
a~z : 27~52 week; z represents
52 and 53 week
X : A~Z : Green

Part Number	Package	Identification Code
AH1894-FA-7	X1-DFN1216-4	B4

(2) Package Type: SOT553

(Top View)

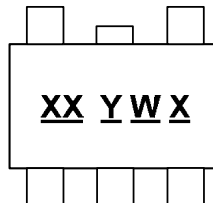

XX : Identification Code
Y : Year : 0 to 9
W : Week : A to Z : 1~26 week;
a to z : 27~52 week; z represents
52 and 53 week
X : Internal code

Part Number	Package	Identification Code
AH1894-Z-7	SOT553	B4

Package Outline Dimensions (All dimensions in mm.)

Please see AP02002 at <http://www.diodes.com/datasheets/ap02002.pdf> for latest version.

(1) Package Type: X1-DFN1216-4

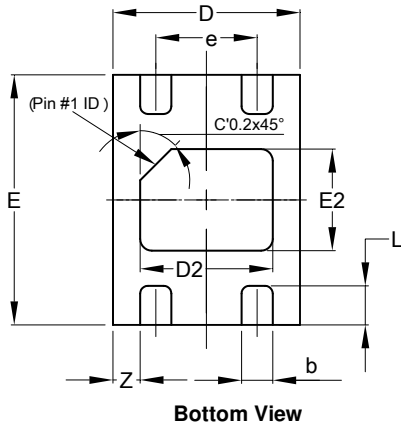
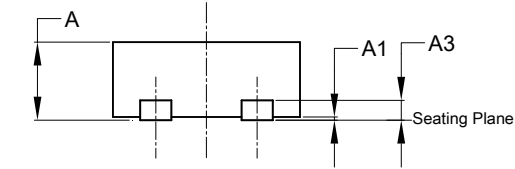

X1-DFN1216-4			
Dim	Min	Max	Typ
A	0.47	0.53	0.50
A1	0.00	0.05	0.02
A3	--	--	0.13
b	0.15	0.25	0.20
D	1.15	1.25	1.20
D2	0.75	0.95	0.85
E	1.55	1.65	1.60
E2	0.55	0.75	0.65
e	-	-	0.65
L	0.20	0.30	0.25
Z	-	-	0.175
All Dimensions in mm			

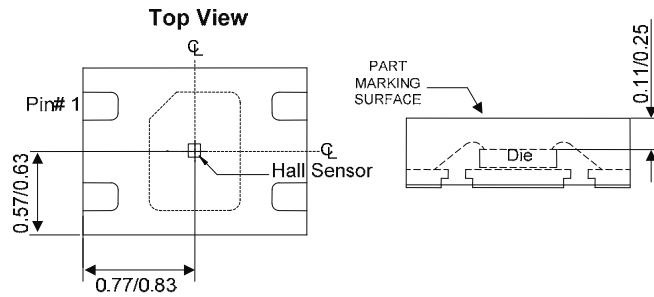

Sensor Location

NEW PRODUCT

Package Outline Dimensions (cont.) (All dimensions in mm.)

(2) Package Type: SOT553

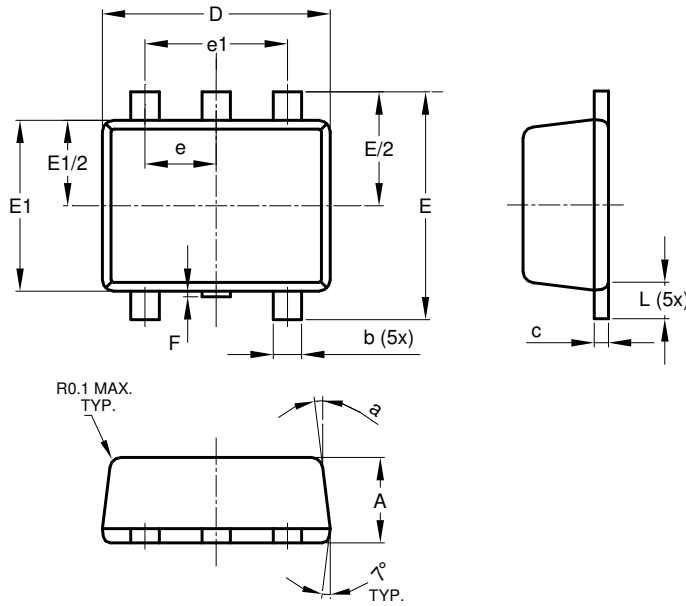

SOT553			
Dim	Min	Max	Typ
A	0.55	0.62	0.60
b	0.15	0.30	0.20
c	0.10	0.18	0.15
D	1.50	1.70	1.60
E	1.55	1.70	1.60
E1	1.10	1.25	1.20
e	0.50 BSC		
e1	1.00 BSC		
F	0.00	0.10	—
L	0.10	0.30	0.20
a	6°	8°	7°
All Dimensions in mm			

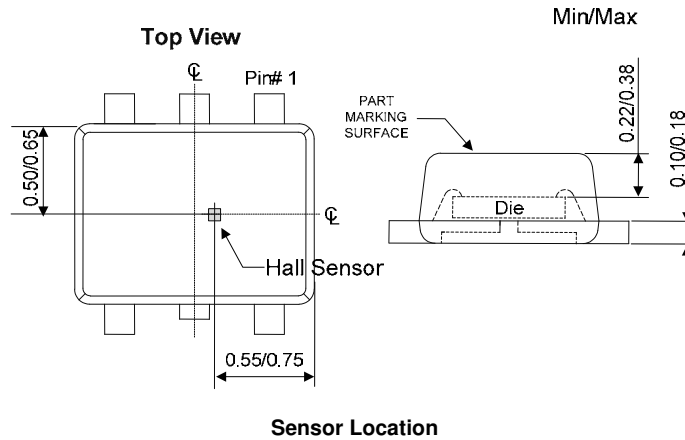

NEW PRODUCT

Suggested Pad Layout

Please see AP02001 at <http://www.diodes.com/datasheets/ap02001.pdf> for the latest version.

(1) Package Type: X1-DFN1216-4

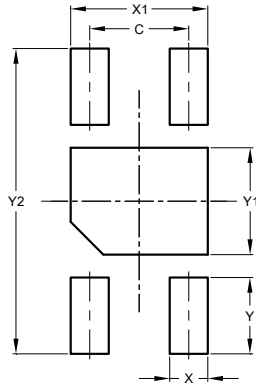

X1-DFN1216-4	
Dimensions	Value
C	0.65
X	0.25
X1	0.90
Y	0.50
Y1	0.70
Y2	2.00
All Dimensions in mm	

(2) Package Type: SOT553

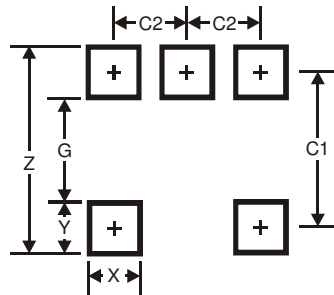

SOT553	
Dimensions	Value
Z	2.2
G	1.2
X	0.375
Y	0.5
C1	1.7
C2	0.5
All Dimensions in mm	

IMPORTANT NOTICE

DIODES INCORPORATED MAKES NO WARRANTY OF ANY KIND, EXPRESS OR IMPLIED, WITH REGARDS TO THIS DOCUMENT, INCLUDING, BUT NOT LIMITED TO, THE IMPLIED WARRANTIES OF MERCHANTABILITY AND FITNESS FOR A PARTICULAR PURPOSE (AND THEIR EQUIVALENTS UNDER THE LAWS OF ANY JURISDICTION).

Diodes Incorporated and its subsidiaries reserve the right to make modifications, enhancements, improvements, corrections or other changes without further notice to this document and any product described herein. Diodes Incorporated does not assume any liability arising out of the application or use of this document or any product described herein; neither does Diodes Incorporated convey any license under its patent or trademark rights, nor the rights of others. Any Customer or user of this document or products described herein in such applications shall assume all risks of such use and will agree to hold Diodes Incorporated and all the companies whose products are represented on Diodes Incorporated website, harmless against all damages.

Diodes Incorporated does not warrant or accept any liability whatsoever in respect of any products purchased through unauthorized sales channel. Should Customers purchase or use Diodes Incorporated products for any unintended or unauthorized application, Customers shall indemnify and hold Diodes Incorporated and its representatives harmless against all claims, damages, expenses, and attorney fees arising out of, directly or indirectly, any claim of personal injury or death associated with such unintended or unauthorized application.

Products described herein may be covered by one or more United States, international or foreign patents pending. Product names and markings noted herein may also be covered by one or more United States, international or foreign trademarks.

This document is written in English but may be translated into multiple languages for reference. Only the English version of this document is the final and determinative format released by Diodes Incorporated.

LIFE SUPPORT

Diodes Incorporated products are specifically not authorized for use as critical components in life support devices or systems without the express written approval of the Chief Executive Officer of Diodes Incorporated. As used herein:

A. Life support devices or systems are devices or systems which:

1. are intended to implant into the body, or
2. support or sustain life and whose failure to perform when properly used in accordance with instructions for use provided in the labeling can be reasonably expected to result in significant injury to the user.

B. A critical component is any component in a life support device or system whose failure to perform can be reasonably expected to cause the failure of the life support device or to affect its safety or effectiveness.

Customers represent that they have all necessary expertise in the safety and regulatory ramifications of their life support devices or systems, and acknowledge and agree that they are solely responsible for all legal, regulatory and safety-related requirements concerning their products and any use of Diodes Incorporated products in such safety-critical, life support devices or systems, notwithstanding any devices- or systems-related information or support that may be provided by Diodes Incorporated. Further, Customers must fully indemnify Diodes Incorporated and its representatives against any damages arising out of the use of Diodes Incorporated products in such safety-critical, life support devices or systems.

Copyright © 2013, Diodes Incorporated

www.diodes.com