

# CC3100MOD SimpleLink™ Wi-Fi® Network Processor Module - BoosterPack Hardware

## User's Guide



Literature Number: SWRU396B  
December 2014—Revised May 2018

<b>1</b>	<b>Introduction</b> .....	<b>4</b>
1.1	CC3100 Module BoosterPack (CC3100MODBOOST).....	4
1.2	What is Included.....	4
1.3	FCC/IC Regulatory Compliance.....	4
<b>2</b>	<b>Hardware Description</b> .....	<b>5</b>
2.1	Block Diagram .....	6
2.2	Hardware Features.....	6
2.3	Connector and Jumper Descriptions .....	6
2.4	Power .....	8
2.5	Measure the CC3100 Current Drawn .....	10
2.6	Performing Conducted Testing .....	11
<b>3</b>	<b>Connecting to the PC Using EMUBOOST</b> .....	<b>13</b>
3.1	CC31XXEMUBOOST .....	13
3.2	Connecting the Boards.....	14
3.3	Jumper Settings on the CC3100MODBOOST .....	15
3.4	Jumper Settings on the EMUBOOST .....	15
<b>4</b>	<b>Connecting to a LaunchPad</b> .....	<b>16</b>
4.1	LaunchPad Current Limitation .....	16
<b>5</b>	<b>Additional Information</b> .....	<b>17</b>
5.1	Design Files .....	17
5.2	Software.....	17
5.3	Hardware Change Log .....	17
5.4	Known Limitations .....	17
	<b>Revision History</b> .....	<b>18</b>

## List of Figures

1	CC3100MOD BoosterPack Board With the CC3100MOD .....	4
2	CC3100MODBOOST Front Side .....	5
3	CC3100MODBOOST Block Diagram .....	6
4	Signal Assignments.....	7
5	3.3-V Power From MCU .....	9
6	Feed USB on the BoosterPack (if the LaunchPad Cannot Source 5 V on 20-Pin Connector) .....	9
7	3.3-V Power From LDO .....	10
8	Feed USB on the BoosterPack (Always While Using the Onboard LDO) .....	10
9	Low Current Measurement.....	11
10	Active Current Measurement .....	11
11	Connectors on the Board .....	12
12	Resistor Switch for Radiated versus Conducted Tests.....	12
13	CC31XXEMUBOOST Board.....	13
14	Portable Devices .....	14
15	The CC3100BOOST Connected to the EMUBOOST .....	15
16	CC3100MODBOOST Connected to MSP430F5529 LaunchPad .....	16
17	Jumper Settings When Used With LaunchPad .....	16

## List of Tables

1	Push Buttons .....	6
2	LEDs.....	7
3	Jumper Settings.....	7
4	Outer Row Connectors.....	8
5	Inner Row Connectors .....	8
6	Ports Available on J6 .....	14
7	Ports Available on J5 .....	14
8	CC3100MODBOOST Jumper Settings.....	15
9	EMUBOOST Jumper Settings .....	15
10	Hardware Change Log.....	17

# **CC3100MOD SimpleLink™ Wi-Fi® Network Processor Module BoosterPack Hardware**

## **1 Introduction**

### **1.1 CC3100 Module BoosterPack (CC3100MODBOOST)**

Add Wi-Fi to any low-cost, low-power microcontroller (MCU) for Internet of Things (IoT) applications using the CC3100 Module BoosterPack (CC3100MODBOOST), which hosts the CC3100 module (CC3100MOD). The CC3100MOD is FCC, IC, CE, and Wi-Fi certified. It integrates all protocols for Wi-Fi and Internet, greatly minimizing host MCU software requirements. With built-in security protocols, the CC3100MOD solution provides a robust and simple security experience. The CC3100MOD integrates the serial flash, RF filter, crystal, and all required passive components.

This document explains the various configurations, usage, and versatility of the CC3100MODBOOST. First, it can be connected to a TI MCU LaunchPad (provided examples for MSP430F5529LP). Second, it can be plugged into a CC31XXEMUBOOST board and connected to a PC for MCU emulation. The CC3100MODBOOST firmware updates requires either the CC31XXEMUBOOST board, or the microcontroller over-the-air(OTA) software and access to a server. Finally, the exposed signals on the 20 pin connector provide an interface to an additional microcontroller or platforms beyond TI's LaunchPads. The CC3100MODBOOST is a complete platform solution, including various tools and software, sample applications, user and programming guides, reference designs, and the TI E2E™ support community. Visit the [CC3100 Wiki page](#) for design resources and example projects



**Figure 1. CC3100MOD BoosterPack Board With the CC3100MOD**

### **1.2 What is Included**

- The CC3100MODBOOST board
- One Micro USB cable
- Quick Start guide

### **1.3 FCC/IC Regulatory Compliance**

The CC3100MOD SimpleLink Wi-Fi and IoT Solution module is FCC Part 15 and IC ICES-003 Class A Certified.

## 2 Hardware Description

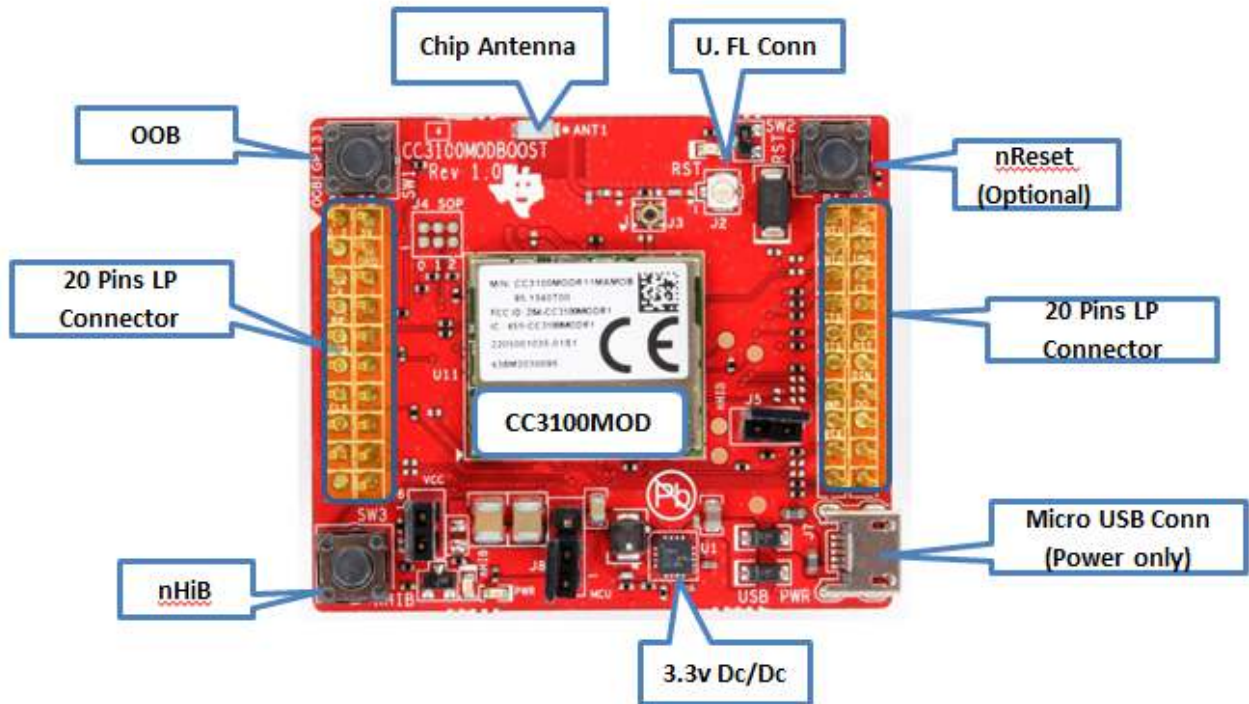

Figure 2. CC3100MODBOOST Front Side

## 2.1 Block Diagram

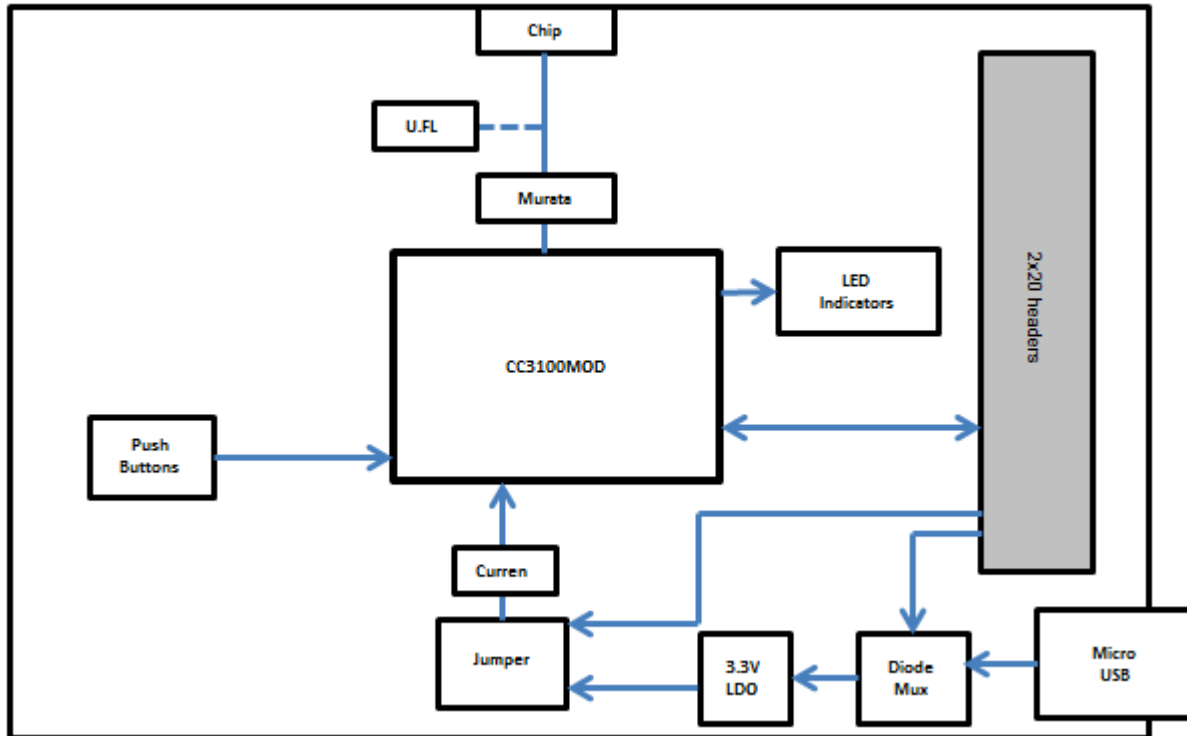

Figure 3. CC3100MODBOOST Block Diagram

## 2.2 Hardware Features

- CC3100MOD module with fully integrated solution
- 2×20 pin stackable connectors
- Power from on-board LDO, using USB or 3.3 V from MCU LaunchPad
- Three (3) push buttons
- Jumper for current measurement with provision to mount 0.1R resistor for measurement with voltmeter
- 8 Mbit serial flash (M25PX80 from Micron)
- 40-MHz crystal, 32-KHz crystal, and optional 32-KHz oscillator
- 2-layer PCB with 6-mil spacing and track width

## 2.3 Connector and Jumper Descriptions

### 2.3.1 Push Buttons and LEDs

Table 1. Push Buttons

Reference	Usage	Comments
SW1	OOB Demo	Used as an input for the OOB demo.
SW2	RESET	Resets the device to a known state. The use of this pin is optional.
SW3	nHIB	Boots the device to the bootloader mode for flashing the firmware over a universal asynchronous receiver/transmitter (UART).

**Table 2. LEDs**

Reference	Color	Usage	Comments
D5	Red	PWR Indication	ON, when the 3.3-V power is provided to the board.
D1	Yellow	nRESET	This LED indicates the state of the nRESET pin. If this LED is glowing, the device is functional.
D6	Green	nHIB	This LED indicates the state of the nHIB pin. When the LED is OFF, the device is in hibernate state.

**2.3.2 Jumper Settings**

**Table 3. Jumper Settings**

Reference	Usage	Comments
J7	USB connector	For powering the booster pack when mated with a Launchpad. This is mandatory when using “Z” devices. For example, CC3100HZ.
J8	Power selection	Choose the power supply from the Launchpad or the on-board USB. J8 (1-2) power from MCU Launchpad J8 (2-3) power from on-board USB using 3.3-V LDO
J6	Current measurement	For Hibernate and LPDS currents, connect an ammeter across J26 : Range (<500 uA) For Active current, mount an 0.1-Ω resistor on R42 and measure the voltage across the 0.1-Ω resistor using a voltmeter. Range (<50 mV peak-peak)
J5	OOB Demo	Closed: GPIO_12 is hard pulled to V <sub>cc</sub> Open: GPIO_12 is pulled to GND using 33K resistor.
J10, J9	Booster pack header	2x10 pins each connected to the Launchpad.
J3	RF Test	Murata connector (MM8030-2610) for production line tests.
J2	RF Test	U.FL connector for conducted testing in the lab.

**2.3.3 2x20 Pin Connector Assignment**

The signal assignment on the 2x20 pin connector is shown in [Figure 4](#). The convention of J1..J4 is replaced with P1...P4 to avoid confusion with the actual board reference.



**Figure 4. Signal Assignments**



**Table 4. Outer Row Connectors**

Pin No	Signal Name	Direction	Pin No	Signal Name	Direction
P1.1	VCC (3.3 V)	IN	P2.1	GND	IN
P1.2	UNUSED	NA	P2.2	IRQ	OUT
P1.3	UART1_TX	OUT	P2.3	SPI_CS	IN
P1.4	UART1_TX	IN	P2.4	UNUSED	NA
P1.5	nHIB	IN	P2.5	nRESET	IN
P1.6	UNUSED	NA	P2.6	SPI_MOSI	IN
P1.7	SPI_CLK	IN	P2.7	SPI_MISO	OUT
P1.8	UNUSED	NA	P2.8	UNUSED	NA
P1.9	UNUSED	NA	P2.9	UNUSED	NA
P1.10	UNUSED	NA	P2.10	UNUSED	NA

**Table 5. Inner Row Connectors**

Pin No	Signal Name	Direction	Pin No	Signal Name	Direction
P3.1	+5 V	IN	P4.1	UNUSED	OUT
P3.2	GND	IN	P4.2	UNUSED	OUT
P3.3	UNUSED	NA	P4.3	UNUSED	NA
P3.4	UNUSED	NA	P4.4	UART1_CTS	IN
P3.5	UNUSED	NA	P4.5	UART1_RTS	OUT
P3.6	UNUSED	NA	P4.6	UNUSED	NA
P3.7	UNUSED	NA	P4.7	NWP_LOG_TX	OUT
P3.8	UNUSED	NA	P4.8	WLAN_LOG_TX	OUT
P3.9	UNUSED	NA	P4.9	UNUSED	IN
P3.10	UNUSED	NA	P4.10	UNUSED	

---

**NOTE:** All signals are 3.3-V CMOS 400-mA logic levels, and are referred w.r.t. CC3100MOD IC. For example, UART1\_TX is an output from the CC3100MOD. For the SPI lines, the CC3100MOD always acts like a slave.

---

## 2.4 Power

The board is designed to accept power from a connected LaunchPad or from the CC3100EMUBOOST board. Some of the LaunchPads are not capable of sourcing the peak current requirements of Wi-Fi. In this case, the USB connector on the CC3100MODBOOST can be used to aid the peak current. The use of Schottky diodes ensure that the load sharing occurs between the USB connectors on the LaunchPad and the BoosterPack without any board modifications.

The 3.3-V power can also be sourced from the LaunchPad, or from the 3.3-V LDO on the board by using jumper J8. If the LaunchPad is not able to source the 3.3 V up to 350 mA, configure the J8 to work from the on-board LDO.

### 2.4.1 Power From the LaunchPad or CC3100EMUBOOST

The most common scenario is to power the CC3100MODBOOST from the connected LaunchPad. In this case, the LaunchPad provides 3.3 V to the BoosterPack for its operation (see [Figure 5](#)). In addition to the 3.3 V, some LaunchPads provide a 5 V from the USB (see [Figure 6](#)), used to drive a 3.3-V LDO on the BoosterPack. If the LaunchPad is not able to provide the 5 V (for example, the LaunchPad with only 20 pins), then the USB connector on the CC3100MODBOOST should be used to provide the LDO input as shown below.



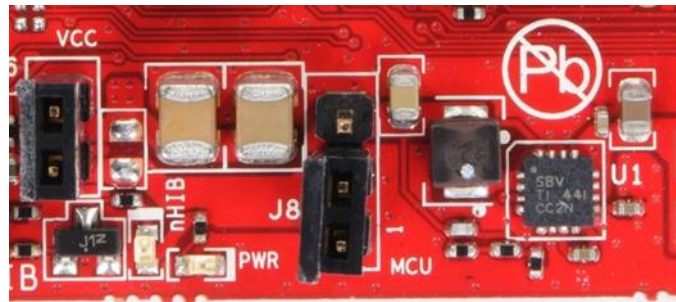

Figure 5. 3.3-V Power From MCU

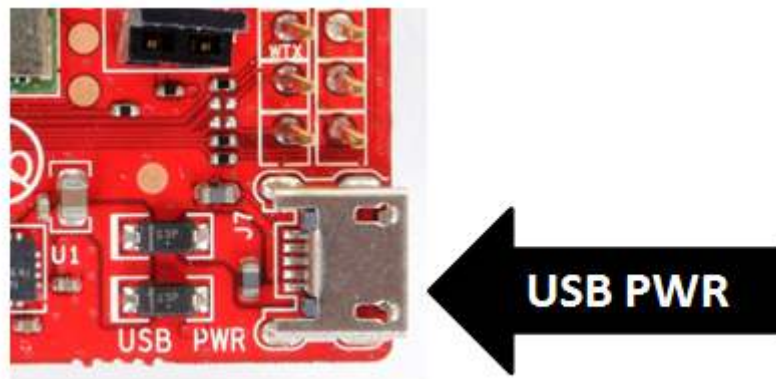

Figure 6. Feed USB on the BoosterPack (if the LaunchPad Cannot Source 5 V on 20-Pin Connector)

#### 2.4.2 On-Board LDO Power Supply

On some LaunchPads, the 3.3 V is not capable of sourcing the 350-mA peak current needed for the CC3100MODBOOST. In this case, the on-board 3.3-V LDO can be used (see [Figure 7](#)). This LDO is sourced from the USB connector on the CC3100MODBOOST and the LaunchPad in a shared load manner.

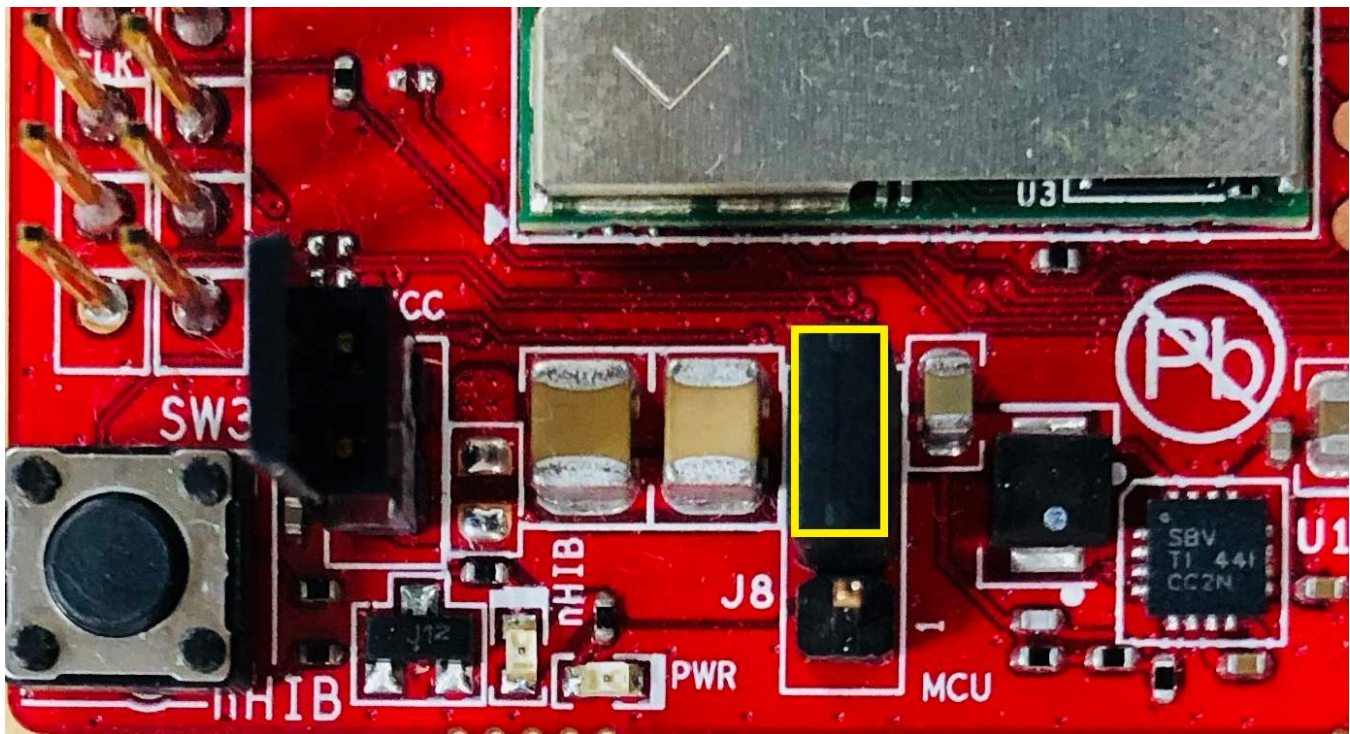

Figure 7. 3.3-V Power From LDO

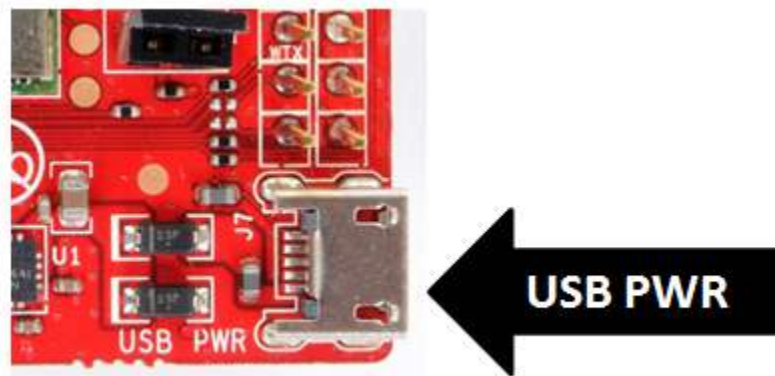

Figure 8. Feed USB on the BoosterPack (Always While Using the Onboard LDO)

## 2.5 Measure the CC3100 Current Drawn

### 2.5.1 Low Current Measurement (Hibernate and LPDS)

To measure the current drawn from the CC3100 device, a jumper is provided on the board labeled J6. By removing this jumper, the user can place an ammeter into this path and observe the current. This method is recommended for measuring LPDS and hibernate currents that are just a few 10s of micro amps. The jumper is removed and an ammeter is added in series to measure the hibernate and LPDS currents (see [Figure 9](#)).

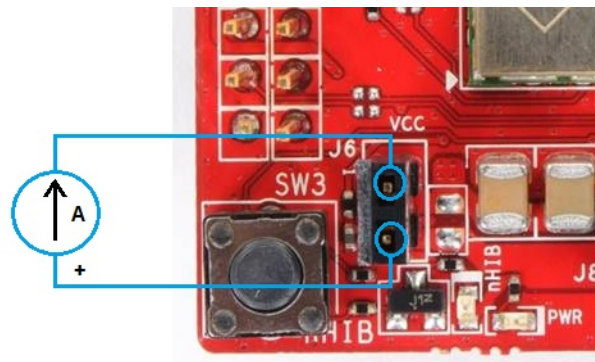

Figure 9. Low Current Measurement

**NOTE:** If the device uses service pack 1.1.0 or higher, the R113 resistor must be removed to get lower LPDS currents. This resistor can leak an extra 33  $\mu$ A from the 3.3-V supply in LPDS mode, if the SPI is used as the host interface.

### 2.5.2 Active Current Measurement

To measure active current in a profile form, use a 0.1- $\Omega$  1% resistor on the board and measure the differential voltage across it. This can be done using a voltmeter or an oscilloscope for measuring the current profile.

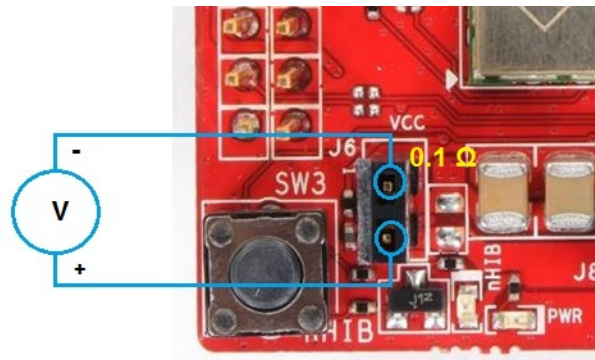

Figure 10. Active Current Measurement

## 2.6 Performing Conducted Testing

By default, the BoosterPack ships with the RF signal connected to the on-board chip antenna. [Figure 11](#) illustrates a miniature UMC connector (Murata MM8030-2610) on the board's RF path for measuring the performance in a conducted mode.

In addition to the Murata connector, a U.FL connector on the board (see [Figure 12](#)) for conducting testing or to connect an external antenna. This requires a board modification, as illustrated in the figures below.



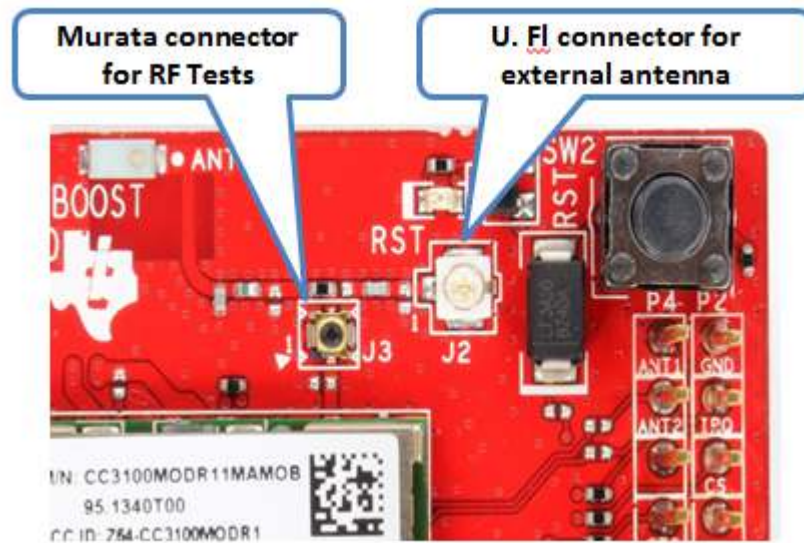

Figure 11. Connectors on the Board

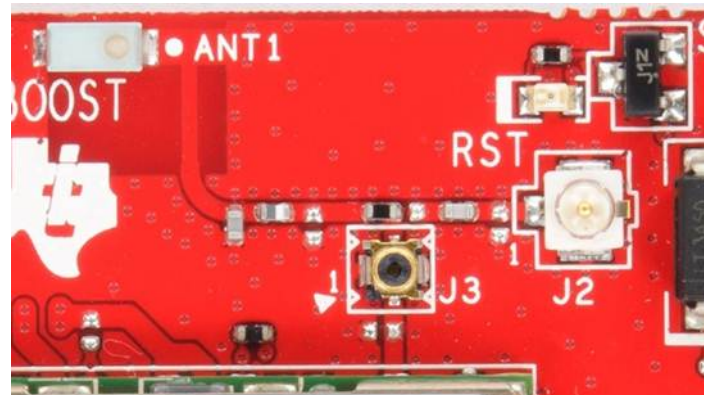

Figure 12. Resistor Switch for Radiated versus Conducted Tests

### 3 Connecting to the PC Using EMUBOOST

#### 3.1 CC31XXEMUBOOST

##### 3.1.1 Overview

The CC31XXEMUBOOST is designed to connect the CC3100 module BoosterPack board to a PC using a USB connection. This updates the firmware patches, which are stored in the serial flash, on the BoosterPack; and in software development using SimpleLink Studio.

##### 3.1.2 Hardware Details

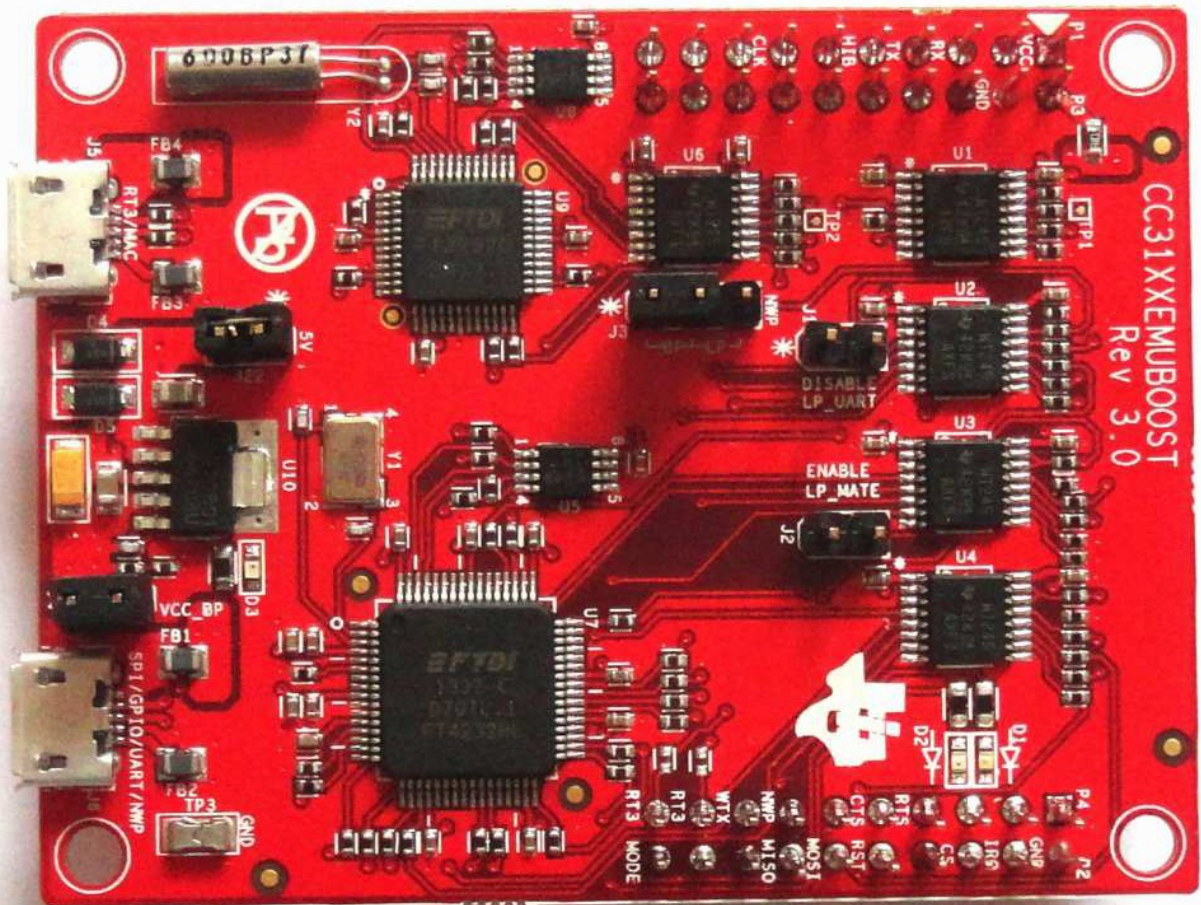

Figure 13. CC31XXEMUBOOST Board

The board has two FTDI ICs to enumerate multiple COM and D2XX ports. The details of the ports are given in [Table 6](#).

**Table 6. Ports Available on J6**

Port Number	Port Type	Usage	Comments
1	D2XX	SPI port for SL Studio	
2	D2XX	GPIO for SL Studio	Control the nRESET, nHIB, IRQ
3	VCP	COM port for Flash programming	
4	VCP	NWP	Network processor logger output. Used with specific tools to analyze the network processor logs. For TI use only.

**NOTE:** On the PC, only two of the four ports are visible on the Device Manager. The D2XX ports are not listed under the Ports tab.

The first COM port in the list is used for the Flash programming.



**Figure 14. Portable Devices**

**Table 7. Ports Available on J5**

Port Number	Port Type	Usage	Comments
1	VCP	RT3	Used for TI internal debug only.
2	VCP	MAC logger	Used for TI internal debug only.

### 3.1.3 Driver Requirements

The FTDI Debug board requires installing the associated drivers on a PC. This package is available as part of the SDK release and is located at: `[Install-Path]\cc3100-sdk\tools\cc31xx_board_drivers\`.

The install path is usually `C:\ti\cc3100SDK`.

### 3.2 Connecting the Boards

[Figure 15](#) shows the connection of the CC3100MOODBOOST to the EMUBOOST Board. The connectors should be aligned carefully, as there is no polarity protection and the sFlash can be erased as a result. The pins #1 of the connectors are marked on the board using a small triangle marking; these should be aligned while connecting.



Figure 15. The CC3100BOOST Connected to the EMUBOOST

**CAUTION**

Align the pin-1 of the boards together using the triangle marking on the PCB. An incorrect connection can destroy the boards permanently. Ensure that none of the header pins are bent before connecting the two boards.

**3.3 Jumper Settings on the CC3100MODBOOST**

Table 8 specifies the jumpers to be installed on the CC3100MODBOOST before pairing with the EMUBOOST board.

**Table 8. CC3100MODBOOST Jumper Settings**

No.	Jumper Settings	Notes
1	J8 (1-2)	Power the BoosterPack from the EMU BOOST. Place the jumper near the edge of the PCB.
3	J6 (short)	No current measurement
4	J5 (short)	OOB demo jumper

**3.4 Jumper Settings on the EMUBOOST**

Table 9 specifies the jumpers to be installed while pairing with the FTDI board.

**Table 9. EMUBOOST Jumper Settings**

No.	Jumper Settings	Notes
1	J4 (short)	Provide 3.3 V to the BoosterPack
2	J22 (short)	Provide 5.0 V to the BoosterPack
3	J3 (1-2)	Route the NWP logs to the dual port



## 4 Connecting to a LaunchPad

The CC3100MODBOOST can be directly connected to a compatible LaunchPad using the standard 2×20 pin connectors. The necessary jumper settings for this connection are the same as those for the EMUBOOST board as described in [Section 3.4](#).

Ensure that the Pin1 of the 2×20 pins is aligned correctly before pairing. [Figure 16](#) illustrates the connected setup. Note that the USB cable is directly connected to the BoosterPack to power it only. For debugging, the USB cable on the LaunchPad is also required.



**Figure 16. CC3100MODBOOST Connected to MSP430F5529 LaunchPad**

### 4.1 LaunchPad Current Limitation

Some of the LaunchPads, including the MSP430FRAM, do not provide enough current to power the CC3100MODBOOST. The BoosterPack can consume up to 400-mA peak from the 3.3 V, and may need power separately.

For this, a USB connector is provided on the BoosterPack to provide the 3.3 V.

The power supply jumpers should be configured as shown in [Figure 17](#) when the power is supplied from the on-board USB connector.



**Figure 17. Jumper Settings When Used With LaunchPad**

---

**NOTE:** Because there are two power sources in this setup, it is important to follow the power-up sequence.

---



---

**NOTE:** Always power the BoosterPack before powering the LaunchPad.

---

## 5 Additional Information

### 5.1 Design Files

All design files including schematics, layout, Bill of Materials (BOM), Gerber files, and documentation are made available in a zip folder that can be downloaded from [www.ti.com/tool/CC3100MODBOOST](http://www.ti.com/tool/CC3100MODBOOST).

### 5.2 Software

All design files, including TI-TXT object-code firmware images, software example projects, and documentation are available from the CC3100MOD device's product page.

The Software Development Kit (SDK) for use with the CC3100MOD BoosterPack is available from <http://www.ti.com/tool/cc3100sdk>.

### 5.3 Hardware Change Log

**Table 10. Hardware Change Log**

PCB Revision	Description
Rev. 1	Initial Release

### 5.4 Known Limitations

1. The serial flash on the module can be programmed mainly through the UART of the CC3100MODBOOST board.

## Revision History

NOTE: Page numbers for previous revisions may differ from page numbers in the current version.

Changes from A Revision (September 2015) to B Revision	Page
• Updated 3.3-V Power From LDO image. ....	10

### STANDARD TERMS FOR EVALUATION MODULES

1. *Delivery:* TI delivers TI evaluation boards, kits, or modules, including any accompanying demonstration software, components, and/or documentation which may be provided together or separately (collectively, an “EVM” or “EVMs”) to the User (“User”) in accordance with the terms set forth herein. User’s acceptance of the EVM is expressly subject to the following terms.
  - 1.1 EVMs are intended solely for product or software developers for use in a research and development setting to facilitate feasibility evaluation, experimentation, or scientific analysis of TI semiconductors products. EVMs have no direct function and are not finished products. EVMs shall not be directly or indirectly assembled as a part or subassembly in any finished product. For clarification, any software or software tools provided with the EVM (“Software”) shall not be subject to the terms and conditions set forth herein but rather shall be subject to the applicable terms that accompany such Software
  - 1.2 EVMs are not intended for consumer or household use. EVMs may not be sold, sublicensed, leased, rented, loaned, assigned, or otherwise distributed for commercial purposes by Users, in whole or in part, or used in any finished product or production system.
2. *Limited Warranty and Related Remedies/Disclaimers:*
  - 2.1 These terms do not apply to Software. The warranty, if any, for Software is covered in the applicable Software License Agreement.
  - 2.2 TI warrants that the TI EVM will conform to TI’s published specifications for ninety (90) days after the date TI delivers such EVM to User. Notwithstanding the foregoing, TI shall not be liable for a nonconforming EVM if (a) the nonconformity was caused by neglect, misuse or mistreatment by an entity other than TI, including improper installation or testing, or for any EVMs that have been altered or modified in any way by an entity other than TI, (b) the nonconformity resulted from User’s design, specifications or instructions for such EVMs or improper system design, or (c) User has not paid on time. Testing and other quality control techniques are used to the extent TI deems necessary. TI does not test all parameters of each EVM. User’s claims against TI under this Section 2 are void if User fails to notify TI of any apparent defects in the EVMs within ten (10) business days after delivery, or of any hidden defects with ten (10) business days after the defect has been detected.
  - 2.3 TI’s sole liability shall be at its option to repair or replace EVMs that fail to conform to the warranty set forth above, or credit User’s account for such EVM. TI’s liability under this warranty shall be limited to EVMs that are returned during the warranty period to the address designated by TI and that are determined by TI not to conform to such warranty. If TI elects to repair or replace such EVM, TI shall have a reasonable time to repair such EVM or provide replacements. Repaired EVMs shall be warranted for the remainder of the original warranty period. Replaced EVMs shall be warranted for a new full ninety (90) day warranty period.
3. *Regulatory Notices:*
  - 3.1 *United States*
    - 3.1.1 *Notice applicable to EVMs not FCC-Approved:*

**FCC NOTICE:** This kit is designed to allow product developers to evaluate electronic components, circuitry, or software associated with the kit to determine whether to incorporate such items in a finished product and software developers to write software applications for use with the end product. This kit is not a finished product and when assembled may not be resold or otherwise marketed unless all required FCC equipment authorizations are first obtained. Operation is subject to the condition that this product not cause harmful interference to licensed radio stations and that this product accept harmful interference. Unless the assembled kit is designed to operate under part 15, part 18 or part 95 of this chapter, the operator of the kit must operate under the authority of an FCC license holder or must secure an experimental authorization under part 5 of this chapter.

3.1.2 *For EVMs annotated as FCC – FEDERAL COMMUNICATIONS COMMISSION Part 15 Compliant:*

**CAUTION**

This device complies with part 15 of the FCC Rules. Operation is subject to the following two conditions: (1) This device may not cause harmful interference, and (2) this device must accept any interference received, including interference that may cause undesired operation.

Changes or modifications not expressly approved by the party responsible for compliance could void the user’s authority to operate the equipment.

**FCC Interference Statement for Class A EVM devices**

## STANDARD TERMS FOR EVALUATION MODULES (continued)

*NOTE: This equipment has been tested and found to comply with the limits for a Class A digital device, pursuant to part 15 of the FCC Rules. These limits are designed to provide reasonable protection against harmful interference when the equipment is operated in a commercial environment. This equipment generates, uses, and can radiate radio frequency energy and, if not installed and used in accordance with the instruction manual, may cause harmful interference to radio communications. Operation of this equipment in a residential area is likely to cause harmful interference in which case the user will be required to correct the interference at his own expense.*

### FCC Interference Statement for Class B EVM devices

*NOTE: This equipment has been tested and found to comply with the limits for a Class B digital device, pursuant to part 15 of the FCC Rules. These limits are designed to provide reasonable protection against harmful interference in a residential installation. This equipment generates, uses and can radiate radio frequency energy and, if not installed and used in accordance with the instructions, may cause harmful interference to radio communications. However, there is no guarantee that interference will not occur in a particular installation. If this equipment does cause harmful interference to radio or television reception, which can be determined by turning the equipment off and on, the user is encouraged to try to correct the interference by one or more of the following measures:*

- Reorient or relocate the receiving antenna.
- Increase the separation between the equipment and receiver.
- Connect the equipment into an outlet on a circuit different from that to which the receiver is connected.
- Consult the dealer or an experienced radio/TV technician for help.

### 3.2 Canada

#### 3.2.1 For EVMs issued with an Industry Canada Certificate of Conformance to RSS-210 or RSS-247

##### Concerning EVMs Including Radio Transmitters:

This device complies with Industry Canada license-exempt RSSs. Operation is subject to the following two conditions:

(1) this device may not cause interference, and (2) this device must accept any interference, including interference that may cause undesired operation of the device.

##### Concernant les EVMs avec appareils radio:

Le présent appareil est conforme aux CNR d'Industrie Canada applicables aux appareils radio exempts de licence. L'exploitation est autorisée aux deux conditions suivantes: (1) l'appareil ne doit pas produire de brouillage, et (2) l'utilisateur de l'appareil doit accepter tout brouillage radioélectrique subi, même si le brouillage est susceptible d'en compromettre le fonctionnement.

##### Concerning EVMs Including Detachable Antennas:

Under Industry Canada regulations, this radio transmitter may only operate using an antenna of a type and maximum (or lesser) gain approved for the transmitter by Industry Canada. To reduce potential radio interference to other users, the antenna type and its gain should be so chosen that the equivalent isotropically radiated power (e.i.r.p.) is not more than that necessary for successful communication. This radio transmitter has been approved by Industry Canada to operate with the antenna types listed in the user guide with the maximum permissible gain and required antenna impedance for each antenna type indicated. Antenna types not included in this list, having a gain greater than the maximum gain indicated for that type, are strictly prohibited for use with this device.

##### Concernant les EVMs avec antennes détachables

Conformément à la réglementation d'Industrie Canada, le présent émetteur radio peut fonctionner avec une antenne d'un type et d'un gain maximal (ou inférieur) approuvé pour l'émetteur par Industrie Canada. Dans le but de réduire les risques de brouillage radioélectrique à l'intention des autres utilisateurs, il faut choisir le type d'antenne et son gain de sorte que la puissance isotrope rayonnée équivalente (p.i.r.e.) ne dépasse pas l'intensité nécessaire à l'établissement d'une communication satisfaisante. Le présent émetteur radio a été approuvé par Industrie Canada pour fonctionner avec les types d'antenne énumérés dans le manuel d'usage et ayant un gain admissible maximal et l'impédance requise pour chaque type d'antenne. Les types d'antenne non inclus dans cette liste, ou dont le gain est supérieur au gain maximal indiqué, sont strictement interdits pour l'exploitation de l'émetteur.

### 3.3 Japan

- 3.3.1 *Notice for EVMs delivered in Japan:* Please see [http://www.tij.co.jp/lstds/ti\\_ja/general/eStore/notice\\_01.page](http://www.tij.co.jp/lstds/ti_ja/general/eStore/notice_01.page) 日本国内に輸入される評価用キット、ボードについては、次のところをご覧ください。  
[http://www.tij.co.jp/lstds/ti\\_ja/general/eStore/notice\\_01.page](http://www.tij.co.jp/lstds/ti_ja/general/eStore/notice_01.page)

## STANDARD TERMS FOR EVALUATION MODULES (continued)

3.3.2 *Notice for Users of EVMs Considered "Radio Frequency Products" in Japan:* EVMs entering Japan may not be certified by TI as conforming to Technical Regulations of Radio Law of Japan.

If User uses EVMs in Japan, not certified to Technical Regulations of Radio Law of Japan, User is required to follow the instructions set forth by Radio Law of Japan, which includes, but is not limited to, the instructions below with respect to EVMs (which for the avoidance of doubt are stated strictly for convenience and should be verified by User):

1. Use EVMs in a shielded room or any other test facility as defined in the notification #173 issued by Ministry of Internal Affairs and Communications on March 28, 2006, based on Sub-section 1.1 of Article 6 of the Ministry's Rule for Enforcement of Radio Law of Japan,
2. Use EVMs only after User obtains the license of Test Radio Station as provided in Radio Law of Japan with respect to EVMs, or
3. Use of EVMs only after User obtains the Technical Regulations Conformity Certification as provided in Radio Law of Japan with respect to EVMs. Also, do not transfer EVMs, unless User gives the same notice above to the transferee. Please note that if User does not follow the instructions above, User will be subject to penalties of Radio Law of Japan.

【無線電波を送信する製品の開発キットをお使いになる際の注意事項】 開発キットの中には技術基準適合証明を受けていないものがあります。技術適合証明を受けていないものご使用に際しては、電波法遵守のため、以下のいずれかの措置を取っていただく必要がありますのでご注意ください。

1. 電波法施行規則第6条第1項第1号に基づく平成18年3月28日総務省告示第173号で定められた電波暗室等の試験設備でご使用いただく。
2. 実験局の免許を取得後ご使用いただく。
3. 技術基準適合証明を取得後ご使用いただく。

なお、本製品は、上記の「ご使用にあたっての注意」を譲渡先、移転先に通知しない限り、譲渡、移転できないものとします。

上記を遵守頂けない場合は、電波法の罰則が適用される可能性があることをご留意ください。 日本テキサス・

インスツルメンツ株式会社  
東京都新宿区西新宿6丁目24番1号  
西新宿三井ビル

3.3.3 *Notice for EVMs for Power Line Communication:* Please see [http://www.tij.co.jp/lstds/ti\\_ja/general/eStore/notice\\_02.page](http://www.tij.co.jp/lstds/ti_ja/general/eStore/notice_02.page)

電力線搬送波通信についての開発キットをお使いになる際の注意事項については、次のところをご覧ください。  
[http://www.tij.co.jp/lstds/ti\\_ja/general/eStore/notice\\_02.page](http://www.tij.co.jp/lstds/ti_ja/general/eStore/notice_02.page)

### 3.4 European Union

3.4.1 *For EVMs subject to EU Directive 2014/30/EU (Electromagnetic Compatibility Directive):*

This is a class A product intended for use in environments other than domestic environments that are connected to a low-voltage power-supply network that supplies buildings used for domestic purposes. In a domestic environment this product may cause radio interference in which case the user may be required to take adequate measures.

### 4 EVM Use Restrictions and Warnings:

- 4.1 EVMs ARE NOT FOR USE IN FUNCTIONAL SAFETY AND/OR SAFETY CRITICAL EVALUATIONS, INCLUDING BUT NOT LIMITED TO EVALUATIONS OF LIFE SUPPORT APPLICATIONS.
- 4.2 User must read and apply the user guide and other available documentation provided by TI regarding the EVM prior to handling or using the EVM, including without limitation any warning or restriction notices. The notices contain important safety information related to, for example, temperatures and voltages.
- 4.3 *Safety-Related Warnings and Restrictions:*

**STANDARD TERMS FOR EVALUATION MODULES (continued)**

- 4.3.1 User shall operate the EVM within TI's recommended specifications and environmental considerations stated in the user guide, other available documentation provided by TI, and any other applicable requirements and employ reasonable and customary safeguards. Exceeding the specified performance ratings and specifications (including but not limited to input and output voltage, current, power, and environmental ranges) for the EVM may cause personal injury or death, or property damage. If there are questions concerning performance ratings and specifications, User should contact a TI field representative prior to connecting interface electronics including input power and intended loads. Any loads applied outside of the specified output range may also result in unintended and/or inaccurate operation and/or possible permanent damage to the EVM and/or interface electronics. Please consult the EVM user guide prior to connecting any load to the EVM output. If there is uncertainty as to the load specification, please contact a TI field representative. During normal operation, even with the inputs and outputs kept within the specified allowable ranges, some circuit components may have elevated case temperatures. These components include but are not limited to linear regulators, switching transistors, pass transistors, current sense resistors, and heat sinks, which can be identified using the information in the associated documentation. When working with the EVM, please be aware that the EVM may become very warm.
- 4.3.2 EVMs are intended solely for use by technically qualified, professional electronics experts who are familiar with the dangers and application risks associated with handling electrical mechanical components, systems, and subsystems. User assumes all responsibility and liability for proper and safe handling and use of the EVM by User or its employees, affiliates, contractors or designees. User assumes all responsibility and liability to ensure that any interfaces (electronic and/or mechanical) between the EVM and any human body are designed with suitable isolation and means to safely limit accessible leakage currents to minimize the risk of electrical shock hazard. User assumes all responsibility and liability for any improper or unsafe handling or use of the EVM by User or its employees, affiliates, contractors or designees.
- 4.4 User assumes all responsibility and liability to determine whether the EVM is subject to any applicable international, federal, state, or local laws and regulations related to User's handling and use of the EVM and, if applicable, User assumes all responsibility and liability for compliance in all respects with such laws and regulations. User assumes all responsibility and liability for proper disposal and recycling of the EVM consistent with all applicable international, federal, state, and local requirements.
5. *Accuracy of Information:* To the extent TI provides information on the availability and function of EVMs, TI attempts to be as accurate as possible. However, TI does not warrant the accuracy of EVM descriptions, EVM availability or other information on its websites as accurate, complete, reliable, current, or error-free.
6. *Disclaimers:*
- 6.1 EXCEPT AS SET FORTH ABOVE, EVMS AND ANY MATERIALS PROVIDED WITH THE EVM (INCLUDING, BUT NOT LIMITED TO, REFERENCE DESIGNS AND THE DESIGN OF THE EVM ITSELF) ARE PROVIDED "AS IS" AND "WITH ALL FAULTS." TI DISCLAIMS ALL OTHER WARRANTIES, EXPRESS OR IMPLIED, REGARDING SUCH ITEMS, INCLUDING BUT NOT LIMITED TO ANY EPIDEMIC FAILURE WARRANTY OR IMPLIED WARRANTIES OF MERCHANTABILITY OR FITNESS FOR A PARTICULAR PURPOSE OR NON-INFRINGEMENT OF ANY THIRD PARTY PATENTS, COPYRIGHTS, TRADE SECRETS OR OTHER INTELLECTUAL PROPERTY RIGHTS.
- 6.2 EXCEPT FOR THE LIMITED RIGHT TO USE THE EVM SET FORTH HEREIN, NOTHING IN THESE TERMS SHALL BE CONSTRUED AS GRANTING OR CONFERRING ANY RIGHTS BY LICENSE, PATENT, OR ANY OTHER INDUSTRIAL OR INTELLECTUAL PROPERTY RIGHT OF TI, ITS SUPPLIERS/LICENSORS OR ANY OTHER THIRD PARTY, TO USE THE EVM IN ANY FINISHED END-USER OR READY-TO-USE FINAL PRODUCT, OR FOR ANY INVENTION, DISCOVERY OR IMPROVEMENT, REGARDLESS OF WHEN MADE, CONCEIVED OR ACQUIRED.
7. *USER'S INDEMNITY OBLIGATIONS AND REPRESENTATIONS.* USER WILL DEFEND, INDEMNIFY AND HOLD TI, ITS LICENSORS AND THEIR REPRESENTATIVES HARMLESS FROM AND AGAINST ANY AND ALL CLAIMS, DAMAGES, LOSSES, EXPENSES, COSTS AND LIABILITIES (COLLECTIVELY, "CLAIMS") ARISING OUT OF OR IN CONNECTION WITH ANY HANDLING OR USE OF THE EVM THAT IS NOT IN ACCORDANCE WITH THESE TERMS. THIS OBLIGATION SHALL APPLY WHETHER CLAIMS ARISE UNDER STATUTE, REGULATION, OR THE LAW OF TORT, CONTRACT OR ANY OTHER LEGAL THEORY, AND EVEN IF THE EVM FAILS TO PERFORM AS DESCRIBED OR EXPECTED.
8. *Limitations on Damages and Liability:*



**STANDARD TERMS FOR EVALUATION MODULES (continued)**

- 8.1 *General Limitations.* IN NO EVENT SHALL TI BE LIABLE FOR ANY SPECIAL, COLLATERAL, INDIRECT, PUNITIVE, INCIDENTAL, CONSEQUENTIAL, OR EXEMPLARY DAMAGES IN CONNECTION WITH OR ARISING OUT OF THESE TERMS OR THE USE OF THE EVMS, REGARDLESS OF WHETHER TI HAS BEEN ADVISED OF THE POSSIBILITY OF SUCH DAMAGES. EXCLUDED DAMAGES INCLUDE, BUT ARE NOT LIMITED TO, COST OF REMOVAL OR REINSTALLATION, ANCILLARY COSTS TO THE PROCUREMENT OF SUBSTITUTE GOODS OR SERVICES, RETESTING, OUTSIDE COMPUTER TIME, LABOR COSTS, LOSS OF GOODWILL, LOSS OF PROFITS, LOSS OF SAVINGS, LOSS OF USE, LOSS OF DATA, OR BUSINESS INTERRUPTION. NO CLAIM, SUIT OR ACTION SHALL BE BROUGHT AGAINST TI MORE THAN TWELVE (12) MONTHS AFTER THE EVENT THAT GAVE RISE TO THE CAUSE OF ACTION HAS OCCURRED.
- 8.2 *Specific Limitations.* IN NO EVENT SHALL TI'S AGGREGATE LIABILITY FROM ANY USE OF AN EVM PROVIDED HEREUNDER, INCLUDING FROM ANY WARRANTY, INDEMNITY OR OTHER OBLIGATION ARISING OUT OF OR IN CONNECTION WITH THESE TERMS, EXCEED THE TOTAL AMOUNT PAID TO TI BY USER FOR THE PARTICULAR EVM(S) AT ISSUE DURING THE PRIOR TWELVE (12) MONTHS WITH RESPECT TO WHICH LOSSES OR DAMAGES ARE CLAIMED. THE EXISTENCE OF MORE THAN ONE CLAIM SHALL NOT ENLARGE OR EXTEND THIS LIMIT.
9. *Return Policy.* Except as otherwise provided, TI does not offer any refunds, returns, or exchanges. Furthermore, no return of EVM(s) will be accepted if the package has been opened and no return of the EVM(s) will be accepted if they are damaged or otherwise not in a resalable condition. If User feels it has been incorrectly charged for the EVM(s) it ordered or that delivery violates the applicable order, User should contact TI. All refunds will be made in full within thirty (30) working days from the return of the components(s), excluding any postage or packaging costs.
10. *Governing Law:* These terms and conditions shall be governed by and interpreted in accordance with the laws of the State of Texas, without reference to conflict-of-laws principles. User agrees that non-exclusive jurisdiction for any dispute arising out of or relating to these terms and conditions lies within courts located in the State of Texas and consents to venue in Dallas County, Texas. Notwithstanding the foregoing, any judgment may be enforced in any United States or foreign court, and TI may seek injunctive relief in any United States or foreign court.



## IMPORTANT NOTICE FOR TI DESIGN INFORMATION AND RESOURCES

Texas Instruments Incorporated ("TI") technical, application or other design advice, services or information, including, but not limited to, reference designs and materials relating to evaluation modules, (collectively, "TI Resources") are intended to assist designers who are developing applications that incorporate TI products; by downloading, accessing or using any particular TI Resource in any way, you (individually or, if you are acting on behalf of a company, your company) agree to use it solely for this purpose and subject to the terms of this Notice.

TI's provision of TI Resources does not expand or otherwise alter TI's applicable published warranties or warranty disclaimers for TI products, and no additional obligations or liabilities arise from TI providing such TI Resources. TI reserves the right to make corrections, enhancements, improvements and other changes to its TI Resources.

You understand and agree that you remain responsible for using your independent analysis, evaluation and judgment in designing your applications and that you have full and exclusive responsibility to assure the safety of your applications and compliance of your applications (and of all TI products used in or for your applications) with all applicable regulations, laws and other applicable requirements. You represent that, with respect to your applications, you have all the necessary expertise to create and implement safeguards that (1) anticipate dangerous consequences of failures, (2) monitor failures and their consequences, and (3) lessen the likelihood of failures that might cause harm and take appropriate actions. You agree that prior to using or distributing any applications that include TI products, you will thoroughly test such applications and the functionality of such TI products as used in such applications. TI has not conducted any testing other than that specifically described in the published documentation for a particular TI Resource.

You are authorized to use, copy and modify any individual TI Resource only in connection with the development of applications that include the TI product(s) identified in such TI Resource. NO OTHER LICENSE, EXPRESS OR IMPLIED, BY ESTOPPEL OR OTHERWISE TO ANY OTHER TI INTELLECTUAL PROPERTY RIGHT, AND NO LICENSE TO ANY TECHNOLOGY OR INTELLECTUAL PROPERTY RIGHT OF TI OR ANY THIRD PARTY IS GRANTED HEREIN, including but not limited to any patent right, copyright, mask work right, or other intellectual property right relating to any combination, machine, or process in which TI products or services are used. Information regarding or referencing third-party products or services does not constitute a license to use such products or services, or a warranty or endorsement thereof. Use of TI Resources may require a license from a third party under the patents or other intellectual property of the third party, or a license from TI under the patents or other intellectual property of TI.

TI RESOURCES ARE PROVIDED "AS IS" AND WITH ALL FAULTS. TI DISCLAIMS ALL OTHER WARRANTIES OR REPRESENTATIONS, EXPRESS OR IMPLIED, REGARDING TI RESOURCES OR USE THEREOF, INCLUDING BUT NOT LIMITED TO ACCURACY OR COMPLETENESS, TITLE, ANY EPIDEMIC FAILURE WARRANTY AND ANY IMPLIED WARRANTIES OF MERCHANTABILITY, FITNESS FOR A PARTICULAR PURPOSE, AND NON-INFRINGEMENT OF ANY THIRD PARTY INTELLECTUAL PROPERTY RIGHTS.

TI SHALL NOT BE LIABLE FOR AND SHALL NOT DEFEND OR INDEMNIFY YOU AGAINST ANY CLAIM, INCLUDING BUT NOT LIMITED TO ANY INFRINGEMENT CLAIM THAT RELATES TO OR IS BASED ON ANY COMBINATION OF PRODUCTS EVEN IF DESCRIBED IN TI RESOURCES OR OTHERWISE. IN NO EVENT SHALL TI BE LIABLE FOR ANY ACTUAL, DIRECT, SPECIAL, COLLATERAL, INDIRECT, PUNITIVE, INCIDENTAL, CONSEQUENTIAL OR EXEMPLARY DAMAGES IN CONNECTION WITH OR ARISING OUT OF TI RESOURCES OR USE THEREOF, AND REGARDLESS OF WHETHER TI HAS BEEN ADVISED OF THE POSSIBILITY OF SUCH DAMAGES.

You agree to fully indemnify TI and its representatives against any damages, costs, losses, and/or liabilities arising out of your non-compliance with the terms and provisions of this Notice.

This Notice applies to TI Resources. Additional terms apply to the use and purchase of certain types of materials, TI products and services. These include; without limitation, TI's standard terms for semiconductor products (<http://www.ti.com/sc/docs/stdterms.htm>), [evaluation modules](#), and [samples](http://www.ti.com/sc/docs/sampterm.htm) (<http://www.ti.com/sc/docs/sampterm.htm>).

Mailing Address: Texas Instruments, Post Office Box 655303, Dallas, Texas 75265  
Copyright © 2018, Texas Instruments Incorporated