

Product Description

Description:	96.0MHz GSX-223/X SM Crystal
Product family:	GSX-223
Category:	SM Quartz Crystal
Order code:	MP11639

Features

- ▶ Ultra-miniature for maximum space saving
- ▶ Ideal for wireless & mobile applications
- ▶ Metal lid can be grounded to minimise EMI
- ▶ Seam sealed for excellent long-term stability

Additional Information

For further information regarding packaging, construction, material composition, soldering profile and environment, please refer to **GSX-223 Product Information sheet**



For dimensions, refer to package drawing: **D0305-A**

Electrical Specifications

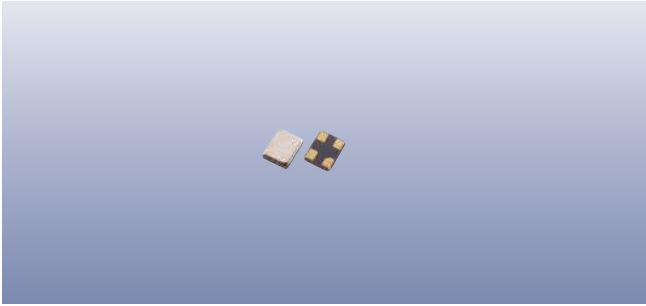
Parameter	Value	Notes
Nominal frequency:	96.0MHz	
Frequency stability:	±16ppm	Referred to the value @25°C
Frequency tolerance:	±12ppm	@25°C ±3°C
Operating temperature range:	-40 to +105°C	
Storage temperature range:	-55 to +125°C	
Circuit condition:	8pF	
Oscillation mode:	Fundamental	
Equivalent series resistance:	20Ω max	
Drive level:	100μW typ, 200μW max	
Static capacitance (C ₁):	3pF max	
Ageing:	±2ppm	Per year



Construction

-  Ceramic body with gold-plated pads
-  Metal lid, seam sealed

Composition



This product is lead-free, and is fully compliant with current RoHS directives



Packaging & Handling

Production quantities supplied on T&R, 3k pcs per reel.
Small quantities may be supplied on tape (no reel), or in bulk.

Marking

FREQUENCY
T DC

Marking type: Laser
DC = Date code

Tape & Reel Specification

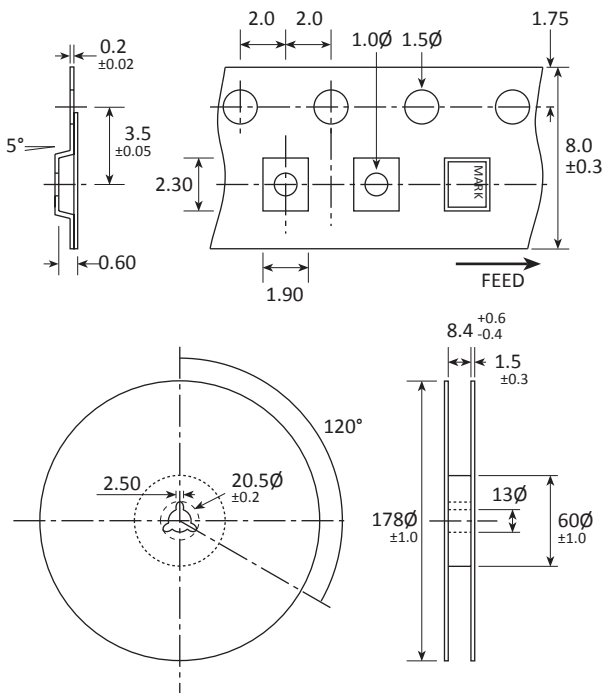

Not to scale. Dimensional tolerances ±0.1mm unless otherwise stated.

Soldering Profile

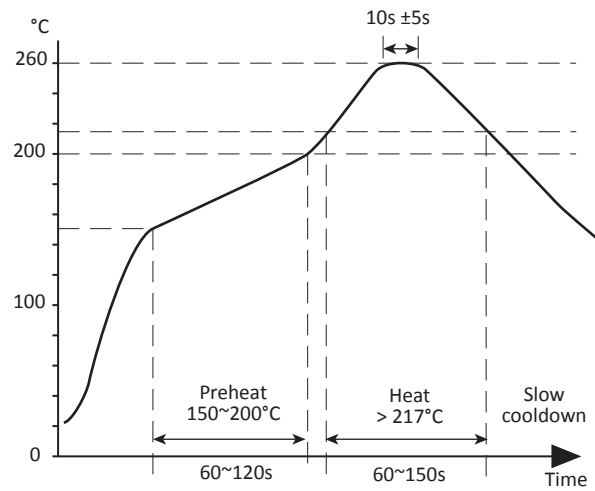

Maximum solder resistance: 260°C x 10 secs x 2.

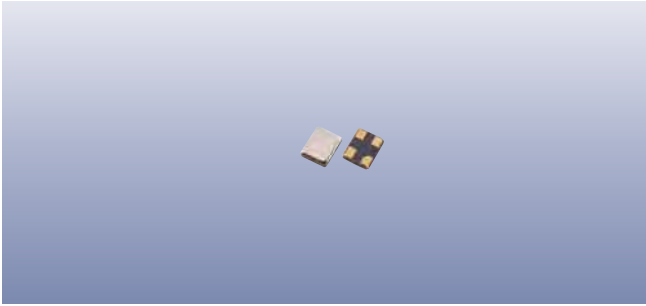

Product Family

GRX-220, GSX-223

Construction

- ▮▮▮▮ Ceramic body with gold-plated pads
- ▮▮▮▮ Metal lid, seam sealed

Dimensions (mm)

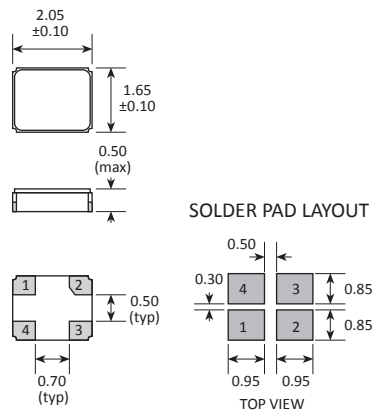

PAD	CONNECTION
1	Crystal
2	Ground & lid
3	Crystal
4	Ground & lid