

STRAIGHT PLUG SOLDER TYPE

R125.052.170

CABLE .085

Series : SMA

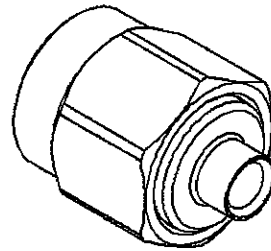
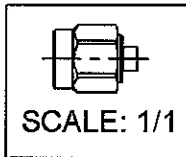
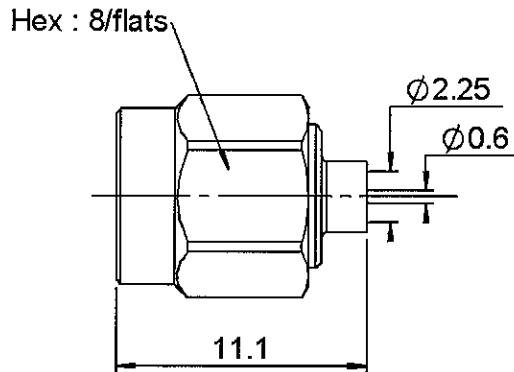

All dimensions are in mm.

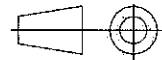

COMPONENTS	MATERIALS	PLATINGS (µm)
BODY	STAINLESS STEEL	GOLD 0.5 OVER NICKEL 2
CENTER CONTACT	BRASS	GOLD 1.3 OVER NICKEL 2
OUTER CONTACT	-	-
INSULATOR	PTFE	-
GASKET	SILICONE RUBBER	-
OTHERS PARTS	STAINLESS STEEL	GOLD 0.5 OVER NICKEL 2
-	-	-
-	-	-

Issue : 0612 G

In the effort to improve our products, we reserve the right to make changes judged to be necessary.



STRAIGHT PLUG SOLDER TYPE

R125.052.170

CABLE .085

Series : SMA

PACKAGING

Standard	Unit	Other
1	-	Contact us

SPECIFICATION

CABLE ASSEMBLY

Stripping	a	b	c	d	e	f
mm	3,17	0,00	0,00	0,00	0,00	0,00

ELECTRICAL CHARACTERISTICS

Impedance	50	Ω
Frequency	0-18	GHz
VSWR	1.07 + 0,0080	x F(GHz) Maxi
Insertion loss	0.03	√F(GHz) dB Maxi
RF leakage	- (90	- F(GHz)) dB mini
Voltage rating	335	Veff Maxi
Dielectric withstanding voltage	750	Veff mini
Insulation resistance	5000	MΩ mini

Assembly instruction :

Recommended cable(s)
RG 405
KS 1

Cable retention

- pull off	130	N mini
- torque	NA	N.cm

MECHANICAL CHARACTERISTICS

Center contact retention		
Axial force – Mating end	NA	N mini
Axial force – Opposite end	NA	N mini
Torque	NA	N.cm mini

Recommended torque

Mating	100	N.cm
Panel nut	NA	N.cm
Clamp nut	NA	N.cm
A/F clamp nut	0,0000	mm

Mating life	500	Cycles mini
Weight	2,2200	g

TOOLING

Part Number	Description	Hexagon
R282.051.000	STRIPPING TOOL	
R282.063.000	POINTER GAUGE	
R282.740.000	SOLDERING MOUNTING	
R282.744.220	SOLDERING POSITIONER (CENTER CONTACT)	
R282.862.060	CONTROL GAUGE	
R282.744.060	SOLDERING POSITIONER (BODY)	
R282.915.010	DIELECTRIC RECESS TOOL	
R282.914.000	CONTROLE GAUGE	
R282.730.040	INSULATOR MOUNTING TOOL	
R282.760.000	SMA RETAINING RING INSERT TOOL	
R282.200.000	PLIERS	

ENVIRONMENTAL

Operating temperature	-65/+105	° C
Hermetic seal	NA	Atm.cm3/s
Panel leakage	NA	

Issue : 0612 G

In the effort to improve our products, we reserve the right to make changes judged to be necessary.



RADIALL®

STRAIGHT PLUG SOLDER TYPE

R125.052.170

CABLE .085

Series : SMA

COMPONENTS

STRIPPING DIMENSIONS

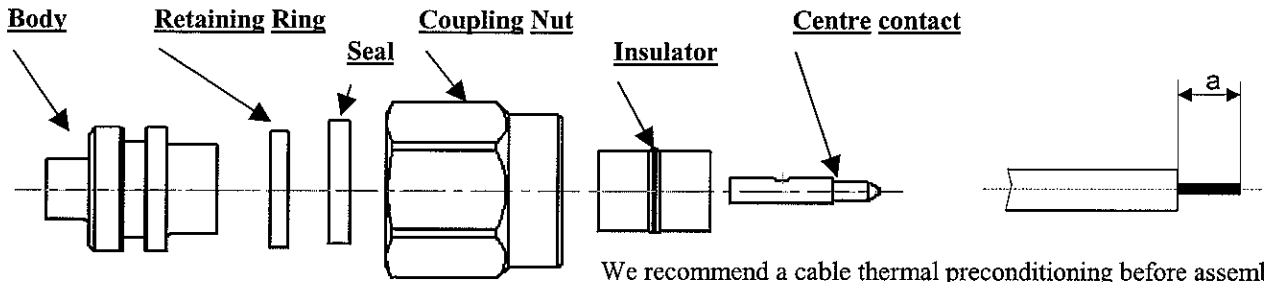

1

Strip the cable with the cable stripping tool.
Trim the cable inner conductor with the trimmer.



2

Screw the positioner onto the soldering jig.
Slide the cable assembly until it bottoms against positioner.
Tighten and solder the contact with solder gauge thickness 0.45

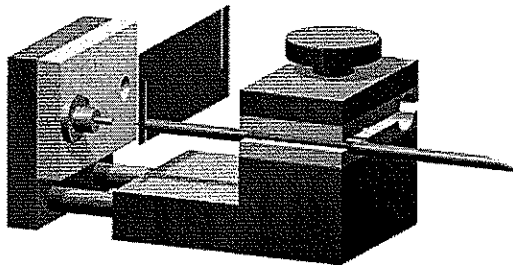

3

Place retaining ring onto its insert tool. Push sub-assembly into the tool until the retaining ring snaps into place.

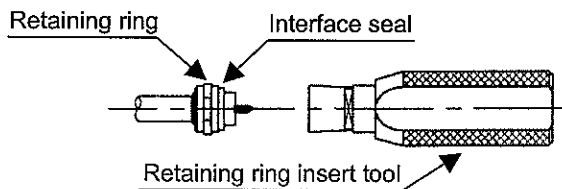

4

Place the interface seal O ring onto body.
Compress retaining ring using retaining pliers.
Push coupling nut onto sub-assembly and over retaining ring

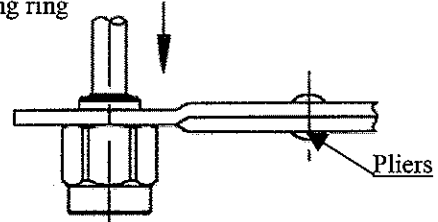

5

Introduce the cable into the body until contact with the body shoulder.
Place the sub-assembly on assembly jig.
Solder body on the cable.
Let assembly cool down before removing it from the jig.

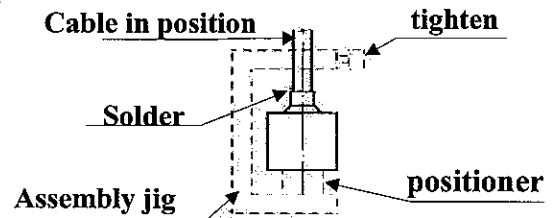

6

Trim dielectric with the dielectric recess tool

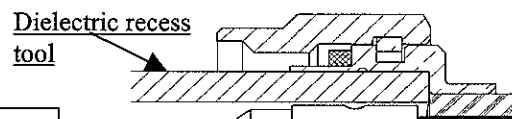

7

Place the insulator with insulator mounting tool

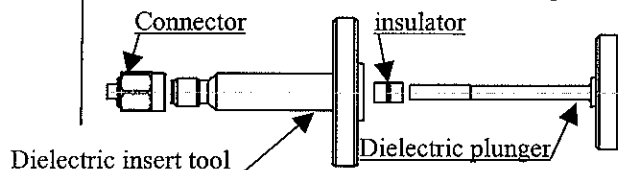

Issue : 0612 G

In the effort to improve our products, we reserve the right to make changes judged to be necessary.

