

# D-SUBMINIATURE



**Positronic**<sup>®</sup>  
global connector solutions



## Professional, Industrial and Military Performance

**THREE PERFORMANCE LEVELS FOR  
BEST COST/PERFORMANCE RATIO**



Catalog C-001 Rev. G

# Connector Excellence®

## Positronic Provides Complete Capability

**Mission Statement**  
*"To utilize product flexibility and application assistance to present quality interconnect solutions which represent value to customers worldwide."*

### Experience

- Founded in **1966**
- **Involvement** in the development of international connector specifications through EIA®, IEC and ISO as well as PICMG®.
- Introduction of new and **unique connector products** to the electronics industry.
- Patent holder for many **unique connector features and manufacturing techniques**.
- **Vertically integrated** manufacturing – raw materials to finished connectors.

### Technology

- **Expertise** with solid machined contacts provides a variety of high reliability connectors including high current density power connectors.
- Quality Assurance lab is **capable of testing** to IEC, EIA, UL, CUL, military and customer-specified requirements.
- **In-house design and development** of connectors based on market need or individual customer requirements.
- **Internal manufacturing capabilities** include automatic precision contact machining, injection molding, stamping, plating operations and connector assembly.
- **Manufacturing locations** in southwest Missouri, U.S.A. (headquarters); Puerto Rico, France, China, Singapore, and India. Total square footage: 407,441.

### Support

- **Quality Systems:** Select locations qualified to ISO 9001, ISO 14001, AS9100, MIL-STD-790 and customer "dock to stock" programs. Applicable products qualified to MIL-DTL-24308, SAE AS39029, DSCC 85039, MIL-DTL-28748, Space D32, GSFC S-311-P-4 and GSFC S-311-P-10.
- Compliance to a variety of international and customer specific **environmental requirements**.
- Large **in-house inventory** of finished connectors. Customer specific **stocking programs**.
- Factory direct **technical sales support** in major cities worldwide.
- **One-on-one customer support** from worldwide factory locations.
- World class **web site**.
- **Value-added solutions** and willingness to **develop custom products** with reasonable price and delivery.



### Regional Headquarters

Springfield, MO



Auch, France



Singapore



Products described within this catalog may be protected by one or more of the following US patents:

- #4,900,261<sup>†</sup> #5,255,580 #5,329,697
- #6,260,268 #6,835,079 #7,115,002

<sup>†</sup>Patented in Canada, 1992 Other Patents Pending

Positronic Industries' **FEDERAL SUPPLY CODE** (Cage Code)  
 FOR MANUFACTURERS is **28198**

Unless otherwise specified, **dimensional tolerances** are:

- 1) ±0.001 inches [0.03 mm] for male contact mating diameters.
- 2) ±0.003 inches [0.08 mm] for contact termination diameters.
- 3) ±0.005 inches [0.13 mm] for all other diameters.
- 4) ±0.015 inches [0.38 mm] for all other dimensions.

**POSITRONIC® IS AN ITAR REGISTERED COMPANY**

Information in this catalog is proprietary to Positronic and its subsidiaries. Positronic believes the data contained herein to be reliable. Since the technical information is given free of charge, the user employs such information at his own discretion and risk. Positronic Industries assumes no responsibility for results obtained or damages incurred from use of such information in whole or in part. The following trademarks are registered to Positronic Industries, Inc. in the United States and many other countries: Positronic Industries, Inc.®, Positronic®, Connector Excellence®, P+ logo®, PosiBand®, PosiShop®, Positronic Global Connector Solutions®, Global Connector Solutions®. The color blue as it appears on various connectors is a trademark of Positronic Industries, Inc., Registered in U.S. Patent and Trademark Office.



## CONNECTOR DESCRIPTIONS

### MELO-D and EURO-D CONNECTORS

MD series and ED series, professional level, fixed contacts. Solder cup, wrap post, and printed board contact terminations for inch and metric printed board hole patterns. Six connector variants, 9 through 50 contacts. Female open entry contacts. Connectors conform to IEC 60807-2, Performance Level Two.

### MDX SERIES CONNECTORS

MDX series, industrial level, fixed contacts. Solder cup, straight and right angle (90°) printed board mount contact terminations. Five connector variants, 9 through 50 contacts. PosiBand closed entry female contacts. Connectors conform to IEC 60807-2, Performance Level One.



### SOLI-D CONNECTORS

SD series, professional level, removable contacts. Solder cup, crimp and straight printed board mount contact terminations. Five connector variants, 9 through 50 contacts. PosiBand® closed entry female contacts. Connectors conform to IEC 807-3, Performance Level Two.

### ORD SERIES CONNECTORS

ORD series, professional and industrial levels, removable contacts. Crimp contact terminations. Thermocouple contact options available. Six connector variants, 9 through 50 contacts. IEC 60807-3, Performance Level One or Two.

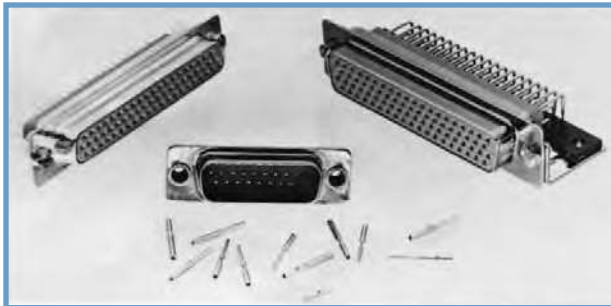

### HARMO-D CONNECTORS

HDC series, MIL-DTL-24308 level, fixed contact. Solder cup, wrap post and straight and right angle (90°) printed board contact terminations. Thermocouple contact options available. Five connector variants, 9 through 50 contacts.

### RHAPSO-D CONNECTORS

RD series, MIL-DTL-24308 / SAE AS39029 levels, removable contacts. Crimp contact terminations. Thermocouple contact options available. Six connector variants, 9 through 50 contacts.



### ODD SERIES CONNECTORS

ODD series, professional and industrial levels, removable contacts. Solder cup, crimp and straight and right angle (90°) printed board contact terminations. Thermocouple contact options available. Six connector variants, 15 through 104 contacts.

### DENSI-D CONNECTORS

DD series, MIL-DTL-24308 / SAE AS39029 levels, removable contacts. Solder cup, crimp and straight and right angle (90°) printed board contact terminations. Thermocouple contact options available. Six connector variants, 15 through 104 contacts.

### STANDARD DENSITY COMPLIANT PRESS-FIT CONNECTORS

PCD series, professional, industrial and military levels, machined contact, compliant termination. Five connector variants, 9 through 50 contacts. IEC 60807-2, Performance Levels One or Two. Military contact plating optional.



### HIGH DENSITY COMPLIANT PRESS-FIT CONNECTORS

PCDD series, professional, industrial and military levels, machined contact, compliant termination. Five connector variants, 15 through 104 contacts. Military contact plating optional.



Connector Descriptions . . . . .	i
Wire Harness Connectors . . . . .	v
Other D-subminiature Products . . . . .	95

## GENERAL INFORMATION

What Makes Positronic's New "PosiBand®" Contact Interface a Significant Improvement? . . . . .	1
The PosiBand® contact system has many advantages over the legacy split tine design. . . . .	2
Exploded Views of Typical Mated D-subminiature Connector Assemblies . . . . .	3
Connector Component Description and Terminology . . . . .	4

## MD SERIES

Technical Characteristics . . . . .	5
Contact Variants and Standard Shell Assembly . . . . .	6
Solder Cup Termination - Code 2; Straight Printed Board Mount Termination - Code 3, 32 and 33; Ferrite Inductor Bar For EMI/RFI Noise Suppression - Code F and Q; and Wrap Post Termination - Code 6 . . . . .	7
Right Angle (90°) Printed Board Mount Termination - Code 5 and Code 59 . . . . .	8
Right Angle (90°) Printed Board Mount Termination - Code 4; and Right Angle (90°) and Straight Printed Board Contact Hole Pattern . . . . .	9
Ordering Information . . . . .	10

## MDX SERIES

Technical Characteristics . . . . .	11
Contact Variants and Standard Shell Assembly . . . . .	12
Solder Cup Termination - Code 2; Straight Printed Board Mount Termination - Code 3, 32 and 33; and Right Angle (90°) Printed Board Mount Termination - Code 4 . . . . .	13
Right Angle (90°) Printed Board Mount Termination - Code 5; and Right Angle (90°) and Straight Printed Board Contact Hole Pattern . . . . .	14
Ordering Information . . . . .	15

## ED SERIES

Technical Characteristics . . . . .	16
Contact Variants and Standard Shell Assembly . . . . .	17
Solder Cup Termination - Code 2; Straight Printed Board Mount Termination - Code 36; and Right Angle (90°) Printed Board Mount Termination - Code 42 and 52 . . . . .	18
Right Angle (90°) Printed Board Mount Termination - Code 44; and Right Angle (90°) and Straight Printed Board Contact Hole Pattern . . . . .	19
Ordering Information . . . . .	20

## SD SERIES

Technical Characteristics . . . . .	21
Contact Variants and Standard Shell Assembly . . . . .	22
Removable Crimp Contacts - Code 1 and 12; and Removable Crimp Contacts - 18 AWG . . . . .	23
Straight Printed Board Mount Termination . . . . .	24
Straight Printed Board Contact Hole Pattern . . . . .	25
Ordering Information . . . . .	26



## HDC SERIES

Technical Characteristics . . . . .	27
Contact Variants and Standard Shell Assembly . . . . .	28
Solder Cup Termination - Code 2; Straight Printed Board Mount Termination - Code 3, 32, 33 and 36; and Wrap Post Termination - Code 6 . . . . .	29
Right Angle (90°) Printed Board Mount Termination - Code 5 and Code 42 . . . . .	30
Right Angle (90°) and Straight Printed Board Contact Hole Pattern . . . . .	31
Ordering Information . . . . .	32

## RD SERIES

Technical Characteristics . . . . .	33
Contact Variants and Standard Shell Assembly . . . . .	34
Removable Crimp Contacts - Code 1 and 12 . . . . .	35
Removable Crimp Contacts - 18 AWG; and Removable Thermocouple Crimp Contacts . . . . .	36
Ordering Information . . . . .	37

## ORD SERIES

Technical Characteristics . . . . .	38
Contact Variants and Standard Shell Assembly . . . . .	39
Removable Crimp Contacts - Code 1 . . . . .	40
Removable Crimp Contacts - 18 AWG; and Removable Thermocouple Crimp Contacts . . . . .	41
Ordering Information . . . . .	42

## ODD SERIES

Technical Characteristics . . . . .	43
Contact Variants and Standard Shell Assembly . . . . .	44
Removable Crimp Contacts - Code 1 . . . . .	45
Removable Crimp Contacts - 20 AWG; and Removable Thermocouple Crimp Contacts . . . . .	46
Removable Solder Cup Contacts - Code 2 . . . . .	47
Fixed Solder Cup Termination - Code 21; and Straight Printed Board Mount Termination - Code 3 and 32 . . . . .	48
Right Angle (90°) Printed Board Mount Termination - Code 5 and Code 4 . . . . .	49
Right Angle (90°) Printed Board Mount Termination - Contact Variant 104 - Code 5 and Code 4 . . . . .	50
Right Angle (90°) and Straight Printed Board Contact Hole Pattern . . . . .	51
Ordering Information . . . . .	52

## DD SERIES

Technical Characteristics . . . . .	53
Contact Variants and Standard Shell Assembly . . . . .	54
Removable Crimp Contacts - Code 1 . . . . .	55
Removable Crimp Contacts - 20 AWG; and Removable Thermocouple Crimp Contacts . . . . .	56
Removable Solder Cup Contacts - Code 2; and Straight Printed Board Mount Contacts - Code 3, 32 and 33 . . . . .	57
Right Angle (90°) Printed Board Mount Termination - Code 4; and Contact Variant 104 - Code 4 . . . . .	58
Right Angle (90°) and Straight Printed Board Contact Hole Pattern . . . . .	59
Ordering Information . . . . .	60



## PCD SERIES

Technical Characteristics . . . . .	61
Contact Variants and Standard Shell Assembly . . . . .	62
Right Angle (90°) Compliant Press-Fit Termination - Code 62; and Straight Compliant Press-Fit Termination - Code 98 . . . . .	63
Right Angle (90°) and Straight Compliant Press-Fit Printed Board Contact Hole Pattern . . . . .	64
Ordering Information . . . . .	65

## PCDD SERIES

Technical Characteristics . . . . .	66
Contact Variants and Standard Shell Assembly . . . . .	67
Right Angle (90°) Compliant Press-Fit Termination - Code 62; and Straight Compliant Press-Fit Termination - Code 98 . . . . .	68
Right Angle (90°) and Straight Compliant Press-Fit Printed Board Contact Hole Pattern . . . . .	69
Ordering Information . . . . .	70

## CONNECTOR SAVERS/ GENDER CHANGERS

AD and HAD Series Technical Characteristics . . . . .	71
AD and HAD Series Contact Variants and Standard Shell Assembly Dimensions . . . . .	72
Jackscrew Systems . . . . .	73
AD and HAD Ordering Information . . . . .	74
DAD Series Technical Characteristics . . . . .	75
DAD Series Contact Variants and Standard Shell Assembly Dimensions . . . . .	76
DAD Ordering Information . . . . .	77

## APPLICATION TOOLS

Introduction . . . . .	78
Reels for Automatic Pneumatic Crimp Tools . . . . .	78
Contact Application Tools Cross Reference List . . . . .	79
Compliant Press-fit Connectors Installation Tools . . . . .	80
Suggested Printed Hole Sizes for Compliant Press-Fit Termination . . . . .	81

## QPL LISTING

Positronic offers a wide variety of QPL connector products. . . . .	82
---	----

*Visit our website for the latest catalog updates and supplements at  
[www.connectpositronic.com/dsub/catalog](http://www.connectpositronic.com/dsub/catalog)*

# WIRE HARNESS CONNECTORS

## SAVE TIME AND MONEY!

Let Positronic support you by cablizing your  
**SD / RD / ORD / ODD / DD** connector selection.

### Cable Assembly Design Support

**We work closely with customers to:**

1. Design assemblies in accordance with customer specifications.
2. Prepare wire harness connector configuration and performance specifications.
3. Design each system in accordance with applicable customer, domestic, and international standards.
4. Define and conduct performance and verification testing.

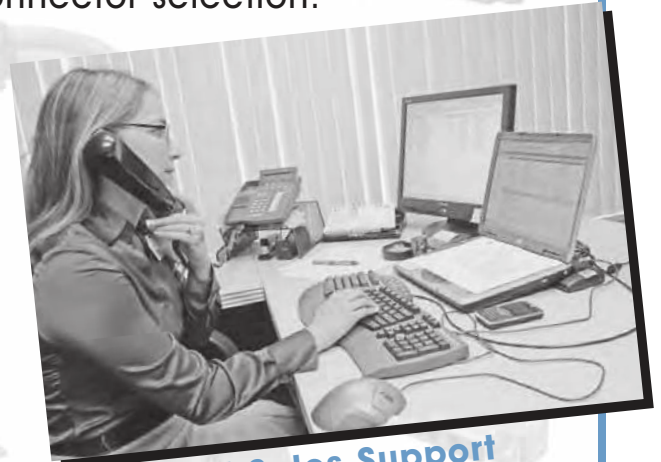

**Technical Sales Support**



**Engineering Support**



**Puerto Rico Cable Assembly**



**Quality Assurance**

FOR MORE DETAILS CONTACT **TECHNICAL SALES**  
OR VISIT OUR **WEB SITE** AT:  
**[CONNECTPOSITRONIC.COM/CABLE-ASSEMBLIES](http://CONNECTPOSITRONIC.COM/CABLE-ASSEMBLIES)**



Positronic  
connectpositronic.com



## What Makes Positronic's New "PosiBand®" Contact Interface a Significant Improvement?

High reliability connectors utilize female **closed entry contacts** that provide an unbroken ring of solid material at the face of the contact. The closed entry feature is **crucial in preventing damage** to female contacts used in harsh environments, repeated mating cycles, blind mate applications and applications requiring highest reliability.

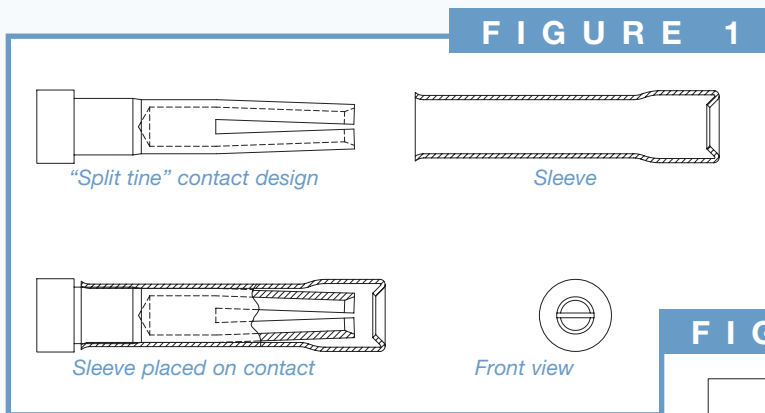

The most common **closed entry design** utilized by connector manufacturers is a split tine and sleeve concept. **See figure 1.** With this design, both the mechanical forces and

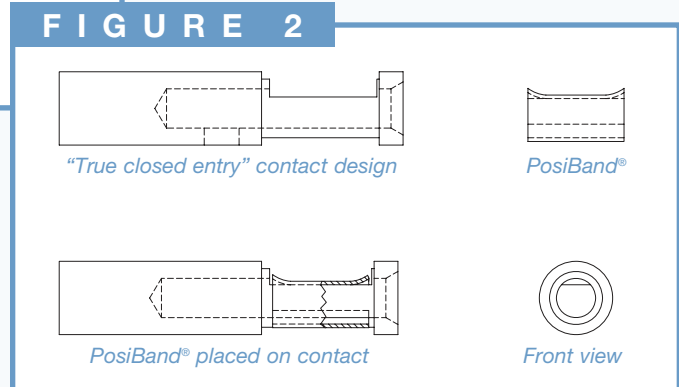

electrical interface are provided only at the tip of the female contact.

Positronic's new **PosiBand technology** takes a unique approach to closed entry female contacts.

**PosiBand** contacts utilize a two-piece contact design. **See figure 2.** Each piece serves a separate function, providing a more mechanically robust contact and more consistent electrical performance.

The main body of the **PosiBand** contact provides a true closed entry opening to enhance robustness. The **PosiBand** spring clip provides normal force on the male contact. Consistent electrical performance is supported through a larger area of contact interface between the male and female contact along the entire "floor" of the contact body. **PosiBand** contacts are QPL listed under **SAE AS39029** and qualified under **GSFC S-311-P4** to the higher 40 gram contact separation test requirement.

*continued on next page . . .*





continued from previous page . . .

## The PosiBand® contact system has many advantages over the legacy split tine design.

- X** **PosiBand** is more robust than the split tine contact, which can be pried open in harsh environments, resulting in reduced normal force and degradation of electrical performance.
- X** **PosiBand** has greater surface area at the male and female contact interface, resulting in more consistent electrical performance.
- X** **PosiBand** has lower average insertion forces, resulting in greater ease in mating, especially in larger high density connectors. The average lower insertion force is accomplished while meeting or exceeding performance requirements.
- X** The **PosiBand's** contact body does not require annealing of the crimp barrels, as does the split tine design. This eliminates concern of unintentionally heat-treating the mating end of the contact, which can cause electrical failure.
- X** **PosiBand** is qualified under **SAE AS39029** specification. **PosiBand** is also qualified under **GSFC S-311-P4/08 Rev C** and **GSFC S-311-P4/10 Rev C** to the higher 40 gram contact separation test requirement.
- X** **PosiBand** is protected by US Patent 7,115,002.

For more details about the *advantages of the PosiBand* system, please view the detailed white paper at [www.connectpositronic.com/white-papers](http://www.connectpositronic.com/white-papers) or visit our web site at [www.connectpositronic.com](http://www.connectpositronic.com).



### TEMPERATURE RISE CURVES

Test conducted in accordance with UL1977.

#### Size 20 PosiBand Contacts

**Initial Contact Resistance:** 0.004 ohms, maximum.  
Curve developed using Standard Density D-subminiature connectors loaded with size 20 crimp contacts terminated to size 20 AWG wire.

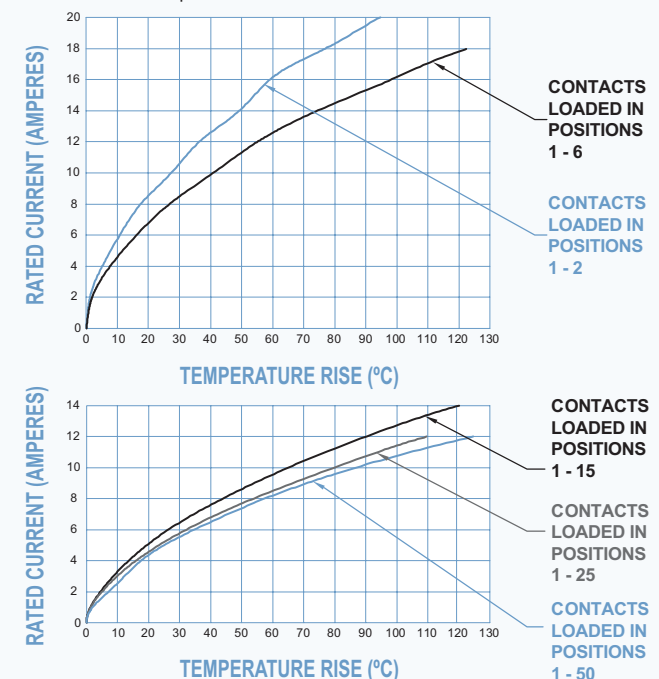
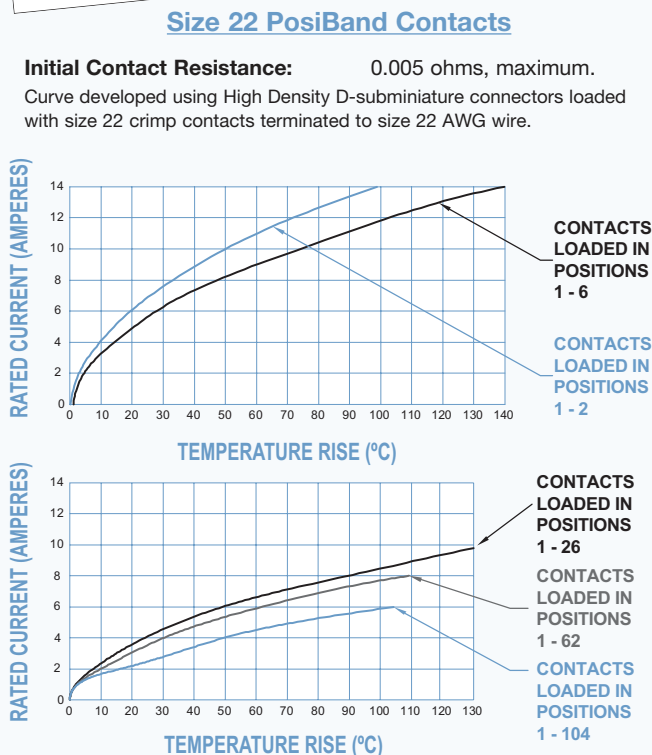

DIMENSIONS ARE IN INCHES [MILLIMETERS].  
ALL DIMENSIONS ARE SUBJECT TO CHANGE.



EXPLODED VIEWS OF TYPICAL MATED  
D-SUBMINIATURE CONNECTOR ASSEMBLIES

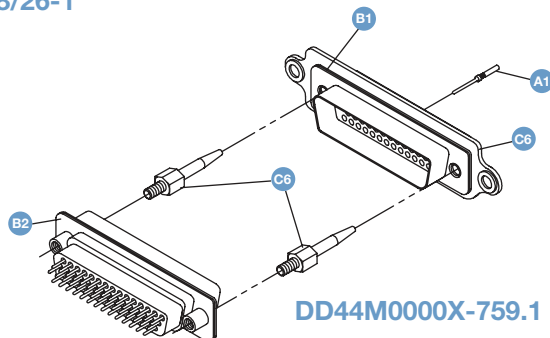
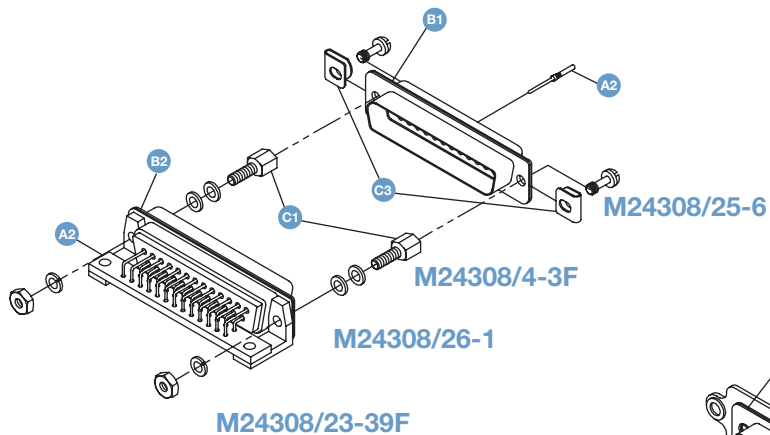
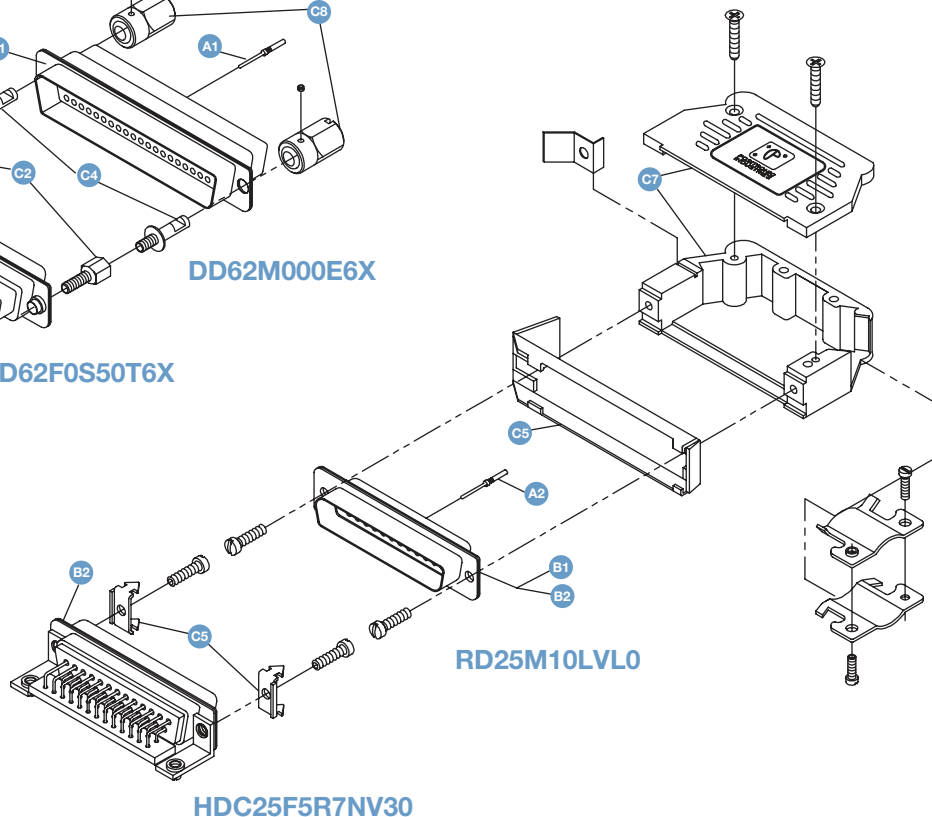
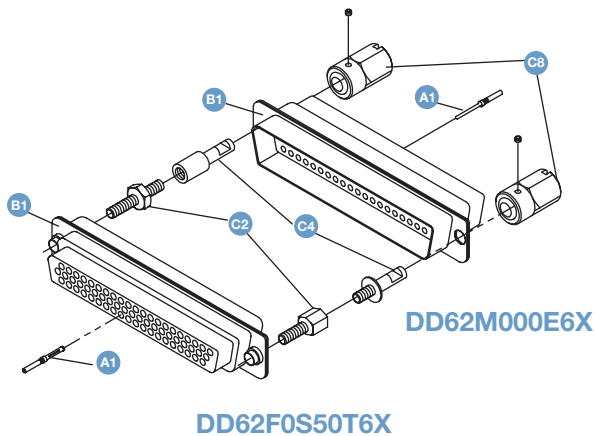



## EXPLODED VIEWS OF TYPICAL MATED D-SUBMINIATURE CONNECTOR ASSEMBLIES

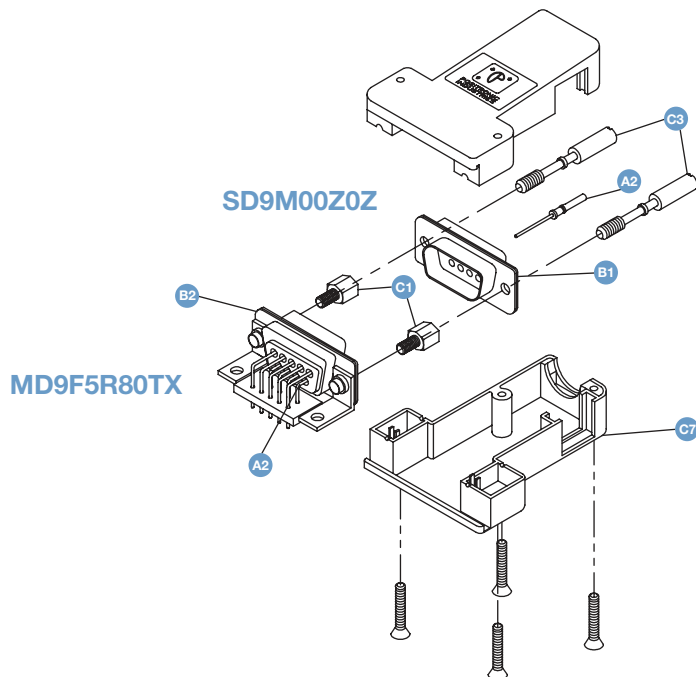

### CONNECTOR COMPONENT DESCRIPTION AND TERMINOLOGY

- A1** - Male and female signal contacts, size 22. Terminations may be crimp, solder cup and printed board mount.
- A2** - Male and female signal contacts, size 20. Terminations may be crimp, solder cup, wrap post, compliant press-fit and printed board mount.
- B1** - Unloaded connector insulators, male and female. Insulator retention system retains all contact termination types. Insulator may be used as a free or fixed connector.
- B2** - Loaded connector insulators, male and female. Insulators may be preloaded per customer requirements with contacts having terminations of right angle (90°) or straight solder printed board mount, wrap post, solder cup and press-fit. Insulator contact positions may be selectively loaded with contacts. Connectors are normally fixed panel or printed board connectors.
- C1** - Fixed female jackscrews are the stationary threaded members of the non-polarized jackscrew system.
- C2** - Fixed male and female jackscrews are the stationary threaded members of the polarized jackscrew system.
- C3** - Rotating male jackscrews and screwlocks are the rotating threaded members of the non-polarized jackscrew system.
- C4** - Rotating male and female jackscrews are the rotating threaded members of the polarized jackscrew system.
- C5** - Vibration locking system consists of lock tabs on fixed connector and slide lock lever on free cable connector.
- C6** - Blind mating connector system with pilot probes on free connector and receptacle guides on panel mounted fixed connector.
- C7** - Cable adapters [Hoods] are used on the free cable connector to provide cable support and contact protection.
- C8** - Knobs of the polarized rotating jackscrew system are affixed to the rotating jackscrew by a set screw.



Positronic  
connectpositronic.com

# PROFESSIONAL QUALITY FIXED CONTACT STANDARD DENSITY D-SUBMINIATURE

D-Sub

## Size 20 Contacts, Fixed

## IEC Publication 60807-2 Performance Level Two

UL Recognized  
File #E49351

CSA Recognized  
File #LR54219

Telecommunication  
UL File #E140980



Melo-D series connectors are professional quality connectors recommended for use in sheltered, non-corrosive indoor or outdoor environments having normal ventilation, but without temperature or humidity controls. These fixed contact connectors meet the dimensional and performance requirements of IEC 60807-2, Performance Level Two.

Melo-D series connectors utilize precision machined contacts which are fixed within the connector body. The female contact is an open entry design contact, precision machined of high tensile phosphor bronze.

Six standard connector variants are offered in arrangements

of 9, 15, 25, 29, 37 and 50 contacts. Each Melo-D connector variant is available with contact terminations for solder cup, wrap post, and straight and right angle (90°) printed board mount terminations featuring a choice of three printed board footprints. Melo-D series connectors are mateable and compatible with all D-subminiature connectors conforming to IEC 60807-2, IEC 60807-3 and MIL-DTL-24308.

A wide assortment of printed board mounting hardware, cable support hoods and locking systems is available from stock.

## MELO-D SERIES TECHNICAL CHARACTERISTICS

### MATERIALS AND FINISHES:

<b>Insulator:</b>	Nylon resin, UL 94V-0, black color.
<b>Contacts:</b>	Precision machined copper alloy.
<b>Contact Plating:</b>	Professional performance Gold flash over nickel plate. Other finishes available upon request.
<b>Shells:</b>	Steel with tin plate; zinc plate with chromate seal, stainless steel passivated. Other materials and finishes available upon request.
<b>Mounting Spacers and Brackets:</b>	Nylon; copper alloy or steel with zinc plate and chromate seal or tin plate; phosphor bronze with tin plate; stainless steel, passivated; polyester.
<b>Push-On Fasteners:</b>	Phosphor bronze or beryllium copper with tin plate.
<b>Jackscrew Systems:</b>	Brass or steel with zinc plate and chromate seal or clear zinc plate or tin plate; stainless steel, passivated.
<b>Vibration Lock Systems:</b>	Slide lock and lock tabs, steel with nickel plate.
<b>Hoods:</b>	Composite and plastic, UL 94V-0; brass or steel with zinc plate and chromate seal. Aluminum; aluminum with electroless nickel plate. For aluminum hoods, zinc content is 1% maximum. Die cast zinc.

Low magnetic versions are available, contact Technical Sales.

### MECHANICAL CHARACTERISTICS:

<b>Fixed Contacts:</b>	Size 20 contact, male - 0.040 inch [1.02mm] mating diameter. Female contact - rugged open entry design.
<b>Contact Retention In Insulator:</b>	6 lbs. [27N]
<b>Resistance To Solder Iron Heat:</b>	500°F [260°C] for 10 seconds duration per IEC 60512-6.

<b>Contact Terminations:</b>	Solder cup contacts - 0.042 inch [1.06mm] minimum hole diameter for 20 AWG [0.5mm <sup>2</sup> ] wire maximum. Straight Printed Board Mount - 0.028 inch [0.71mm] termination diameter. Right Angle (90°) Printed Board Mount - 0.028 inch [0.71mm] termination diameter for all printed board footprints. Wrap Post - 0.025 inch [0.64mm] square.
<b>Shells:</b>	Male shells may be dimpled for EMI/ESD ground paths.
<b>Polarization:</b>	Trapezoidally shaped shells and polarized jackscrews.
<b>Mounting To Angle Brackets:</b>	Jackscrews and riveted fasteners with a 0.120 inch [3.05mm] clearance hole, and threaded riveted fasteners with 4-40 threads and polyester lock inserts.
<b>Mounting To Printed Board:</b>	Rapid installation push-on fasteners and threaded posts.
<b>Locking Systems:</b>	Jackscrews and vibration locking systems.
<b>Mechanical Operations:</b>	500 operations minimum per IEC 60512-5.

### ELECTRICAL CHARACTERISTICS:

<b>Contact Current Rating:</b>	7.5 amperes nominal.
<b>Initial Contact Resistance:</b>	0.008 ohms maximum.
<b>Insulation Resistance:</b>	5 G ohms.
<b>Proof Voltage:</b>	1000 V r.m.s.
<b>Clearance and Creepage Distance [minimum]:</b>	0.039 inch [1.0mm].
<b>Working Voltage:</b>	300 V r.m.s.

### CLIMATIC CHARACTERISTICS:

<b>Temperature Range:</b>	-55°C to +125°C.
<b>Damp Heat, Steady State:</b>	10 days.

*MD series connectors can be supplied with interfacial seals and sealed between shell and insulator. This provides an additional degree of moisture resistance. See Accessories catalog for details.*

**CONTACT VARIANTS**  
FACE VIEW OF MALE OR REAR VIEW OF FEMALE

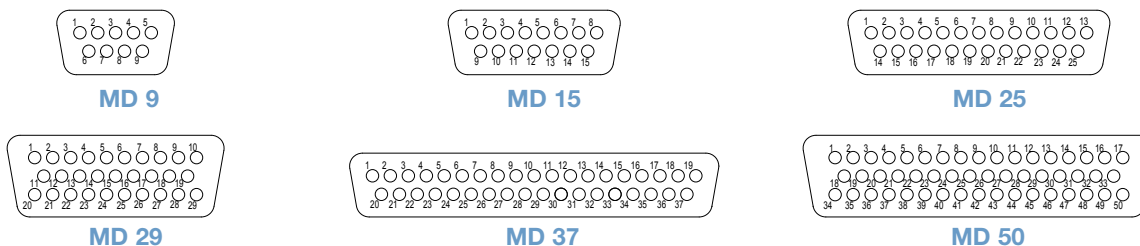

**STANDARD SHELL ASSEMBLY**

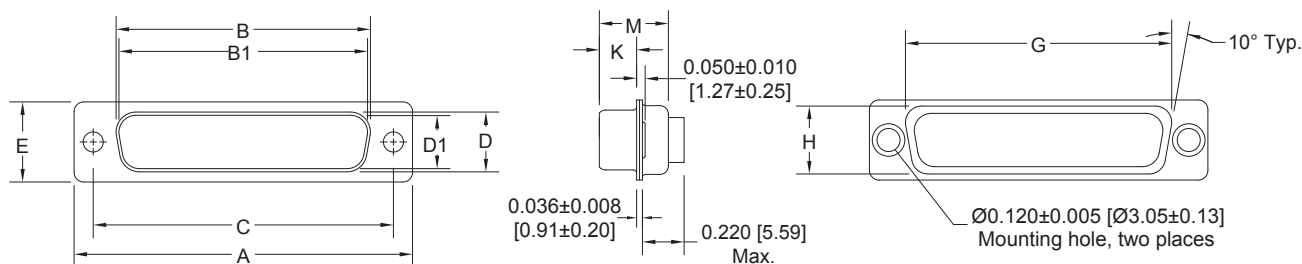

**OPTIONAL SHELL ASSEMBLY (0, 02)**

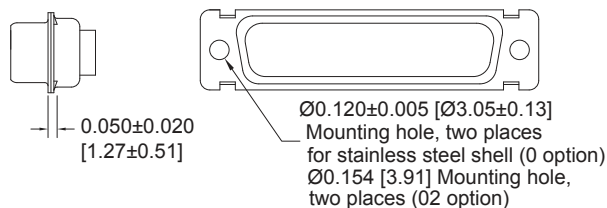

**OPTIONAL SHELL ASSEMBLY WITH UNIVERSAL FLOAT MOUNTS (F)**

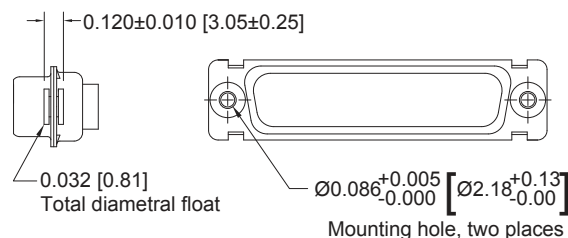

CONNECTOR VARIANT SIZES	A ±0.015 [0.38]	B ±0.005 [0.13]	B1 ±0.005 [0.13]	C ±0.005 [0.13]	D ±0.005 [0.13]	D1 ±0.005 [0.13]	E ±0.015 [0.38]	G ±0.010 [0.25]	H ±0.010 [0.25]	K ±0.005 [0.13]	M ±0.010 [0.25]
9 M	1.213 [30.81]		0.666 [16.92]	0.984 [24.99]		0.329 [8.36]	0.494 [12.55]	0.759 [19.28]	0.422 [10.72]	0.233 [5.92]	0.422 [10.72]
9 F	1.213 [30.81]	0.643 [16.33]		0.984 [24.99]	0.311 [7.90]		0.494 [12.55]	0.759 [19.28]	0.422 [10.72]	0.243 [6.17]	0.429 [10.90]
15 M	1.541 [39.14]		0.994 [25.25]	1.312 [33.32]		0.329 [8.36]	0.494 [12.55]	1.083 [27.51]	0.422 [10.72]	0.233 [5.92]	0.422 [10.72]
15 F	1.541 [39.14]	0.971 [24.66]		1.312 [33.32]	0.311 [7.90]		0.494 [12.55]	1.083 [27.51]	0.422 [10.72]	0.243 [6.17]	0.429 [10.90]
25 M	2.088 [53.04]		1.534 [38.96]	1.852 [47.04]		0.329 [8.36]	0.494 [12.55]	1.625 [41.28]	0.422 [10.72]	0.230 [5.84]	0.426 [10.82]
25 F	2.088 [53.04]	1.511 [38.38]		1.852 [47.04]	0.311 [7.90]		0.494 [12.55]	1.625 [41.28]	0.422 [10.72]	0.243 [6.17]	0.429 [10.90]
29 M	1.770 [44.96]		1.274 [32.36]	1.534 [38.96]		0.450 [11.43]	0.605 [15.37]	1.322 [33.58]	0.539 [13.69]	0.230 [5.84]	0.426 [10.82]
29 F	1.770 [44.96]	1.251 [31.78]		1.534 [38.96]	0.431 [10.95]		0.605 [15.37]	1.322 [33.58]	0.539 [13.69]	0.237 [6.02]	0.429 [10.90]
37 M	2.729 [69.32]		2.182 [55.42]	2.500 [63.50]		0.329 [8.36]	0.494 [12.55]	2.272 [57.71]	0.422 [10.72]	0.230 [5.84]	0.426 [10.82]
37 F	2.729 [69.32]	2.159 [54.84]		2.500 [63.50]	0.311 [7.90]		0.494 [12.55]	2.272 [57.71]	0.422 [10.72]	0.243 [6.17]	0.429 [10.90]
50 M	2.635 [66.93]		2.079 [52.81]	2.406 [61.11]		0.441 [11.20]	0.605 [15.37]	2.178 [55.32]	0.534 [13.56]	0.230 [5.84]	0.426 [10.82]
50 F	2.635 [66.93]	2.064 [52.43]		2.406 [61.11]	0.423 [10.74]		0.605 [15.37]	2.178 [55.32]	0.534 [13.56]	0.243 [6.17]	0.429 [10.90]



Positronic  
connectpositronic.com

# PROFESSIONAL QUALITY FIXED CONTACT STANDARD DENSITY D-SUBMINIATURE

D-Sub

## SOLDER CUP TERMINATION CODE 2

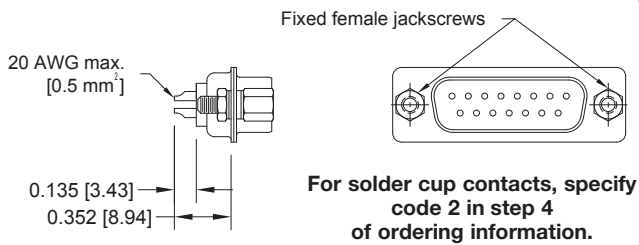

Typical Part Number: MD15M200T2Z

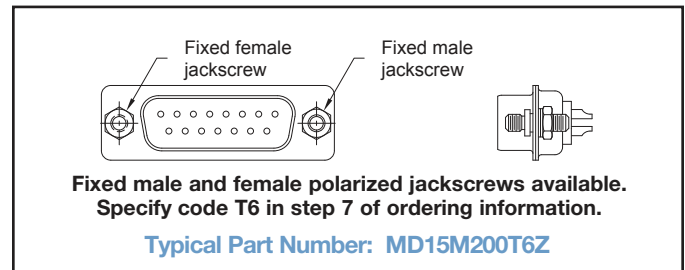

## STRAIGHT PRINTED BOARD MOUNT TERMINATION CODE 3, 32 AND 33

CODE NUMBER	L	ØD
3	0.150 [3.81]	0.028 [0.71]
32	0.375 [9.53]	0.028 [0.71]
33	0.500 [12.70]	0.028 [0.71]

For straight printed board mount contacts, specify code number in step 4 of ordering information.

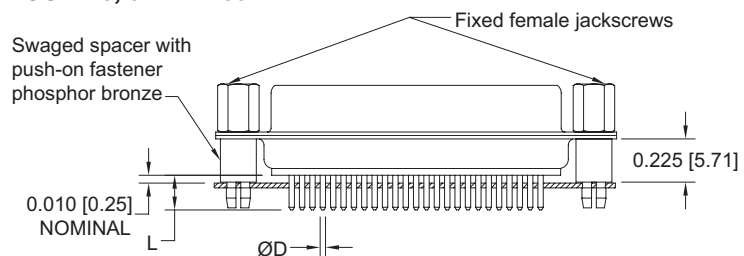

Typical Part Number: MD25F3S60T0

## FERRITE INDUCTOR BAR FOR EMI/RFI NOISE SUPPRESSION CODE F AND Q

STRAIGHT PRINTED BOARD MOUNT CONNECTOR

### FILTERING CHARACTERISTICS

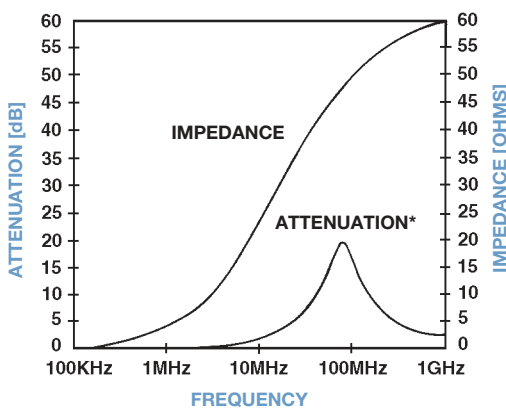

\* NO-LOAD CONDITION

MATERIAL: Nickel zinc ceramic

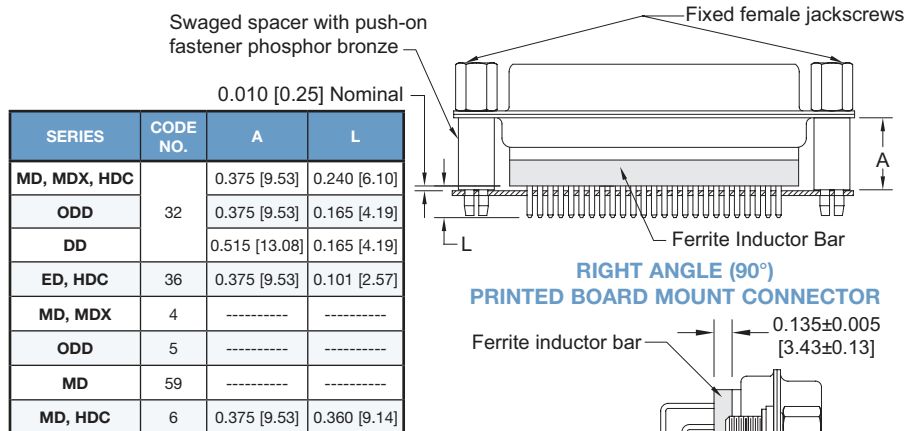

Specify code F or Q in step 6 of ordering information. F for ferrite inductor and Q for ferrite inductor with push-on fastener.

## WRAP POST TERMINATION CODE 6

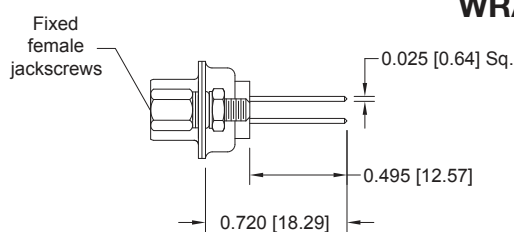

Typical Part Number: MD15F600T20

For wrap post contacts, specify code 6 in step 4 of ordering information.



MD25M6S50T0

**RIGHT ANGLE (90°) PRINTED BOARD MOUNT TERMINATION**  
**CODE 5, 0.283 [7.19] CONTACT EXTENSION**

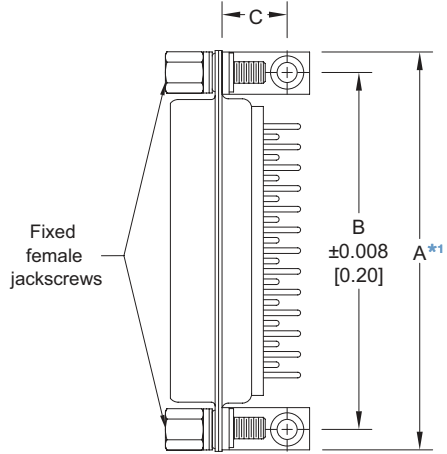

MD**5*** 0.283 [7.19] CONTACT EXTENSION				
PART NUMBER	A*1	B	C	D
MD9*5***	1.204 [30.58]	0.984 [24.99]	0.339 [8.61]	0.283 [7.19]
MD15*5***	1.532 [38.91]	1.312 [33.32]	0.339 [8.61]	0.283 [7.19]
MD25*5***	2.072 [52.63]	1.852 [47.04]	0.339 [8.61]	0.283 [7.19]
MD29*5***	1.754 [44.55]	1.534 [38.96]	0.395 [10.03]	0.283 [7.19]
MD37*5***	2.720 [69.09]	2.500 [63.50]	0.339 [8.61]	0.283 [7.19]
MD50*5***	2.626 [66.70]	2.406 [61.11]	0.395 [10.03]	0.283 [7.19]

**NOTE:**

\*1 "A" dimension applies for metal angle brackets only. Consult Accessories D-subminiature catalog for "A" dimension when plastic brackets are used.

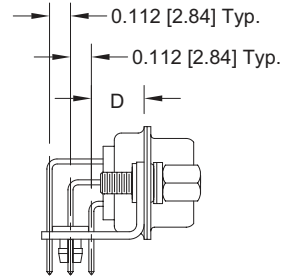
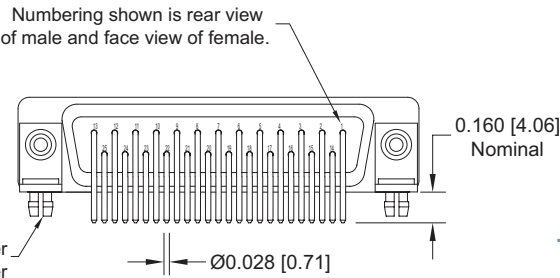
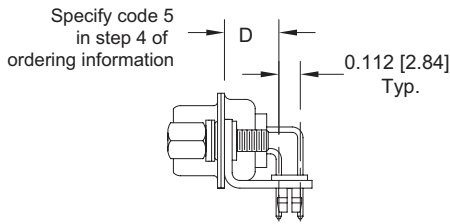

**Typical Part Number:**  
**MD25M5R4NT2X**

Push-on fastener  
beryllium copper

**Typical Part Number:**  
**MD50M5R4NT2X**

**RIGHT ANGLE (90°) PRINTED BOARD MOUNT TERMINATION**  
**CODE 59, 0.545 [13.84] CONTACT EXTENSION**

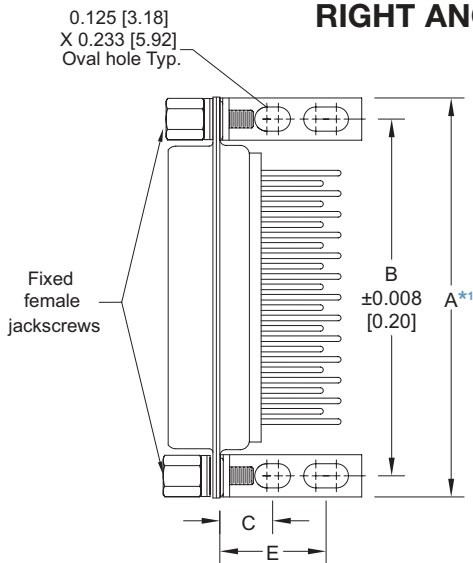

MD**59*** 0.545 [13.84] CONTACT EXTENSION					
PART NUMBER	A*1	B	C	D	E
MD9*59***	1.204 [30.58]	0.984 [24.99]	0.275 [6.99]	0.545 [13.84]	0.601 [15.27]
MD15*59***	1.532 [38.91]	1.312 [33.32]	0.275 [6.99]	0.545 [13.84]	0.601 [15.27]
MD25*59***	2.072 [52.63]	1.852 [47.04]	0.275 [6.99]	0.545 [13.84]	0.601 [15.27]
MD29*59***	1.754 [44.55]	1.534 [38.96]	0.275 [6.99]	0.545 [13.84]	0.657 [16.69]
MD37*59***	2.720 [69.09]	2.500 [63.50]	0.275 [6.99]	0.545 [13.84]	0.601 [15.27]
MD50*59***	2.626 [66.70]	2.406 [61.11]	0.275 [6.99]	0.545 [13.84]	0.657 [16.69]

**NOTE:**

\*1 "A" dimension applies for metal angle brackets only. Consult Accessories D-subminiature catalog for "A" dimension when plastic brackets are used.

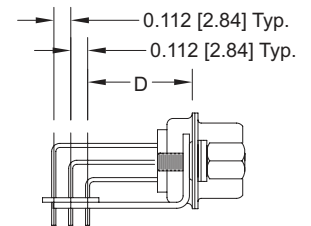
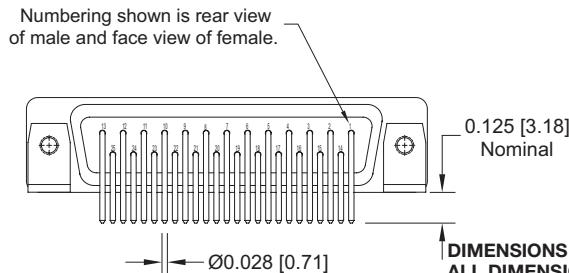
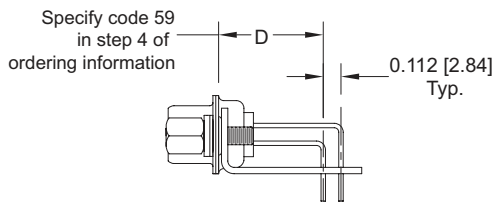

**Typical Part Number:**  
**MD25M59B0T2X**

**DIMENSIONS ARE IN INCHES [MILLIMETERS].  
ALL DIMENSIONS ARE SUBJECT TO CHANGE.**



Positronic  
connectpositronic.com

# PROFESSIONAL QUALITY FIXED CONTACT STANDARD DENSITY D-SUBMINIATURE

D-Sub

## RIGHT ANGLE (90°) PRINTED BOARD MOUNT TERMINATION CODE 4, 0.450 [11.43] CONTACT EXTENSION

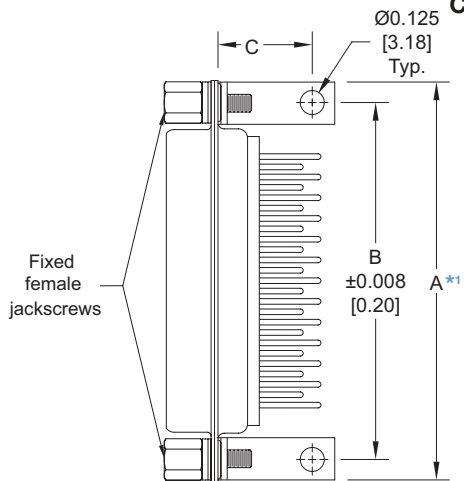

MD**4**** 0.450 [11.43] CONTACT EXTENSION				
PART NUMBER	A*1	B	C	D
MD9*4****	1.204 [30.58]	0.984 [24.99]	0.506 [12.85]	0.450 [11.43]
MD15*4****	1.532 [38.91]	1.312 [33.32]	0.506 [12.85]	0.450 [11.43]
MD25*4****	2.072 [52.63]	1.852 [47.04]	0.506 [12.85]	0.450 [11.43]
MD29*4****	1.754 [44.55]	1.534 [38.96]	0.562 [14.27]	0.450 [11.43]
MD37*4****	2.720 [69.09]	2.500 [63.50]	0.506 [12.85]	0.450 [11.43]
MD50*4****	2.626 [66.70]	2.406 [61.11]	0.562 [14.27]	0.450 [11.43]

**NOTE:**

\*1 "A" dimension applies for metal angle brackets only. Consult Accessories D-subminiature catalog for "A" dimension when plastic brackets are used.

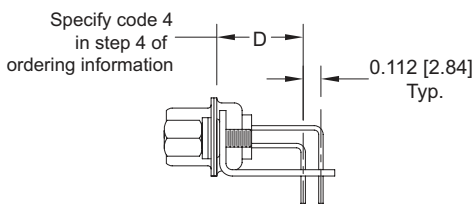

Numbering shown is rear view of male and face view of female.

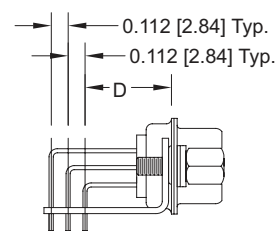
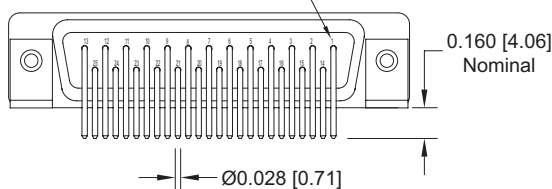

Typical Part Number:  
MD25M4B0T20

Typical Part Number:  
MD50M4B0T20

## RIGHT ANGLE (90°) AND STRAIGHT PRINTED BOARD CONTACT HOLE PATTERN

MOUNT CONNECTOR WITH MATING FACE POSITIONED TO FOLLOW DIRECTION OF ARROW.

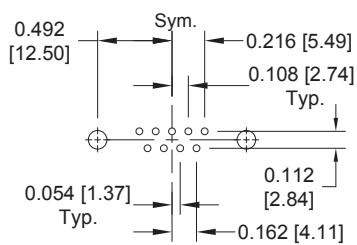

MD9

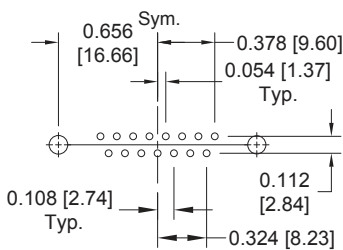

MD15

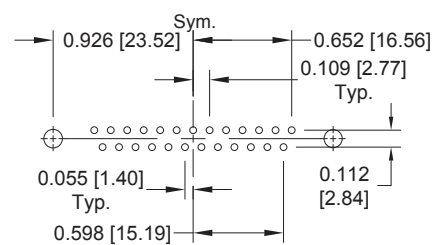

MD25

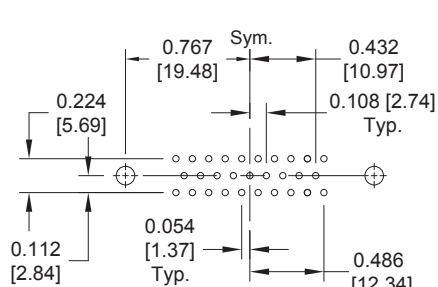

MD29

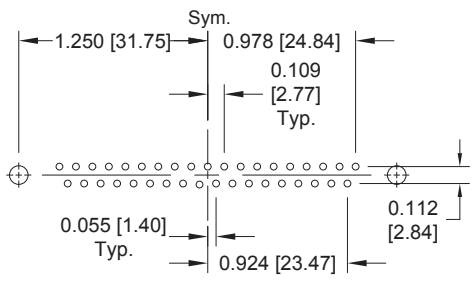

MD37

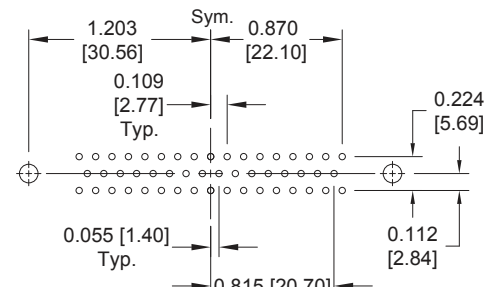

MD50

### SUGGESTED PRINTED BOARD HOLE SIZES:

Suggest 0.045 [1.14] Ø hole for contact termination positions.  
Suggest 0.123 ±0.003 [3.12 ±0.08] Ø hole for mounting connector with push-on fasteners.





## ORDERING INFORMATION - CODE NUMBERING SYSTEM

Specify Complete Connector By Selecting An Option From Step 1 Through 8

STEP	1	2	3	4	5	6	7	8	9	10
EXAMPLE	MD	25	F	59	R7	N	T6	X	/AA	-14
<b>STEP 1 - BASIC SERIES</b> MD series.										<b>STEP 10 - SPECIAL OPTIONS</b> -14 - 0.000030 [0.76µ] gold over nickel. -15 - 0.000050 [1.27µ] gold over nickel. <b>CONTACT TECHNICAL SALES FOR SPECIAL OPTIONS</b>
<b>STEP 2 - CONNECTOR VARIANTS</b> 9, 15, 25, 29, 37, 50										
<b>STEP 3 - CONNECTOR GENDER</b> M - Male F - Female										
<b>STEP 4 - CONTACT TERMINATION TYPE</b> 2 - Solder cup. 3 - Solder, Straight Printed Board Mount with 0.150 [3.81] Tail Length. 32 - Solder, Straight Printed Board Mount with 0.375 [9.52] Tail Length. 33 - Solder, Straight Printed Board Mount with 0.500 [12.70] tail length. 4 - Solder, Right Angle (90°) Printed Board Mount with 0.450 [11.43] Contact Extension. 5 - Solder, Right Angle (90°) Printed Board Mount with 0.283 [7.19] Contact Extension. 59 - Solder, Right Angle (90°) Printed Board Mount with 0.545 [13.84] Contact Extension. 6 - Wrap Post.										
<b>*1 STEP 5 - MOUNTING STYLE</b> 0 - Mounting Hole, 0.120 [3.05] Ø. 02 - Mounting Hole, 0.154 [3.91] Ø. B - Bracket, Mounting, Right Angle (90°) Metal. B3 - Bracket, Mounting, Right Angle (90°) Metal with Cross Bar. B7 - Bracket, Mounting, Right Angle (90°) Plastic. B8 - Bracket, Mounting, Right Angle (90°) Plastic with Cross Bar. F - Float Mounts, Universal. P - Threaded Post, Brass, 0.225 [5.71] Length. P2 - Threaded Post, Nylon, 0.225 [5.71] Length. R - Bracket, Mounting, Right Angle (90°) Metal, Swaged to Connector with 4-40 Thread Fixed Female Jackscrews. R2 - Bracket, Mounting, Right Angle (90°) Metal, Swaged to Connector with 4-40 Thread Fixed Female Jackscrews with Cross Bar. R3 - Bracket, Mounting, Right Angle (90°) Metal, Swaged to Connector with 0.120 [3.05] Ø Mounting Hole. R4 - Bracket, Mounting, Right Angle (90°) Metal, Swaged to Connector with 4-40 Threads. R5 - Bracket, Mounting, Right Angle (90°) Metal, Swaged to Connector with 4-40 Locknut. R6 - Bracket, Mounting, Right Angle (90°) Metal, Swaged to Connector with 0.120 [3.05] Ø Mounting Hole with Cross Bar. R7 - Bracket, Mounting, Right Angle (90°) Metal, Swaged to Connector with 4-40 Threads with Cross Bar. R8 - Bracket, Mounting, Right Angle (90°) Metal, Swaged to Connector with 4-40 Locknut with Cross Bar. S - Swaged Spacer, 4-40 Threads, 0.225 [5.71] Length. S2 - Swaged Spacer, 4-40 Threads, 0.125 [3.18] Length. S5 - Swaged Locknut, 4-40 Threads. S6 - Swaged Spacer with Push-on Fastener, 4-40 Threads, 0.225 [5.71] Length. S7 - Swaged Spacer with Push-on Fastener for use with Ferrite Inductor, 4-40 Threads, 0.375 [9.53] Length.										
<b>STEP 8 - Shell Options</b> 0 - Zinc plated, with chromate seal. *4 S - Stainless steel, passivated. X - Tin plated. Z - Tin plated and dimpled (male connectors only).										
<b>*1 STEP 7 - LOCKING AND POLARIZING SYSTEMS</b> 0 - None. *3 V3 - Lock Tab, connector front panel mounted. *3 V5 - Lock Tab, connector rear panel mounted. *3 VL - Lock Lever, used with Hoods only. T - Fixed Female Jackscrews. T2 - Fixed Female Jackscrews. T6 - Fixed Male and Female Polarized Jackscrews. E - Rotating Male Jackscrews. E2 - Rotating Male Screw Locks. E3 - Rotating Male with Internal Hex for 3/32 Hex Drives E6 - Rotating Male and Female Polarized Jackscrews.										
<b>*1 STEP 6 - HOODS AND PUSH-ON FASTENERS</b> 0 - None. J - Hood, Top Opening, Plastic. L - Hood, Side Opening, Plastic. Y - Hood, Top Opening, Plastic with Rotating Male Jackscrews. Available in size 50 only. Y6 - Hood, Top Opening, Plastic with Rotating Male and Female Polarized Jackscrews. Available in size 50 only. Z - Hood, Top or Side Opening, Robust and Extended Height, Composite and Plastic with Rotating Male Jackscrews. Available in size 9, 15, 25, 37, and 50 only. H - Hood, Top Opening, Metal. Available in size 15, 25, 37, and 50 only. G - Hood, EMI/RFI, Die Cast Zinc. Available in size 9, 15, 25, 37, and 50 only. *5 AN - Lightweight Aluminum Hood, nickel finish. *5 AC - Lightweight Aluminum Hood, no finish. W - Hood, Top or Side Opening, Plastic. Available in size 9, 15, and 25 only. N - Push-on fastener for right angle (90°) mounting brackets. *2 F - Ferrite inductor. *2 Q - Ferrite inductor for use with push-on fastener and right angle (90°) mounting brackets.										
<b>STEP 9 - ENVIRONMENTAL COMPLIANCE OPTIONS</b> /AA - RoHS Compliant <b>NOTE:</b> If compliance to environmental legislation is not required, this step will not be used. Example: MD25F59R7NT6X										

MD SERIES



Positronic  
connectpositronic.com

# INDUSTRIAL QUALITY FIXED CONTACT STANDARD DENSITY D-SUBMINIATURE

D-Sub

Size 20 Contacts, Fixed  
PosiBand® Closed Entry

IEC Publication 60807-2  
Performance Level One

Consult Technical Sales for  
UL Recognition



MDX series connectors are industrial quality connectors recommended for use in sheltered, non-corrosive indoor or outdoor environments having normal ventilation, but without temperature or humidity controls. These fixed contact connectors meet the dimensional and performance requirements of IEC 60807-2, Performance Level One.

MDX series connectors utilize precision machined contacts which are fixed within the connector body. The female utilizes Positronic's unique PosiBand closed entry contact system, see page 1 for details.

Five standard connector variants are offered in arrangements of 9, 15, 25, 37 and 50 contacts. Each variant is available with contact terminations for solder cup and straight and right angle (90°) printed board mount terminations. MDX series connectors are mateable and compatible with all D-subminiature connectors conforming to IEC 60807-2, IEC 60807-3 and MIL-DTL-24308.

A wide assortment of printed board mounting hardware, cable support hoods and locking systems is available from stock.

## MDX SERIES TECHNICAL CHARACTERISTICS

### MATERIALS AND FINISHES:

<b>Insulator:</b>	Glass filled polyester per ASTM D5927, UL 94V-0, blue color.
<b>Contacts:</b>	Precision machined copper alloy.
<b>Contact Plating:</b>	Professional performance Gold flash over nickel plate. Other finishes available upon request.
<b>Shells:</b>	Steel with tin plate; zinc plate with chromate seal, stainless steel passivated. Other materials and finishes available upon request.
<b>Mounting Spacers and Brackets:</b>	Nylon; copper alloy or steel with zinc plate and chromate seal or tin plate; phosphor bronze with tin plate; stainless steel, passivated; polyester.
<b>Push-On Fasteners:</b>	Phosphor bronze or beryllium copper with tin plate.
<b>Jackscrew Systems:</b>	Brass or steel with zinc plate and chromate seal or clear zinc plate or tin plate; stainless steel, passivated.
<b>Vibration Lock Systems:</b>	Slide lock and lock tabs, steel with nickel plate.
<b>Hoods:</b>	Composite and plastic, UL 94V-0; brass or steel with zinc plate and chromate seal. Aluminum; aluminum with electroless nickel plate. For aluminum hoods, zinc content is 1% maximum. Die cast zinc.

Low magnetic versions are available, contact Technical Sales.

### MECHANICAL CHARACTERISTICS:

<b>Fixed Contacts:</b>	Size 20 contact, female contact - PosiBand closed entry design, see page 1 for details.
<b>Contact Retention In Insulator:</b>	6 lbs. [27N]

<b>Contact Terminations:</b>	Solder cup contacts - 0.042 inch [1.06mm] minimum hole diameter for 20 AWG [0.5mm <sup>2</sup> ] wire maximum. Straight Printed Board Mount - 0.028 inch [0.71mm] termination diameter. Right Angle (90°) Printed Board Mount - 0.028 inch [0.71mm] termination diameter for all printed board footprints.
<b>Polarization:</b>	Trapezoidally shaped shells and polarized jackscrews.
<b>Mounting To Angle Brackets:</b>	Jackscrews and riveted fasteners with a 0.120 inch [3.05mm] clearance hole, and threaded riveted fasteners with 4-40 threads and polyester lock inserts.
<b>Mounting To Printed Board:</b>	Rapid installation push-on fasteners and threaded posts.
<b>Locking Systems:</b>	Jackscrews and vibration locking systems.
<b>Mechanical Operations:</b>	1000 operations minimum per IEC 60512-5.

### ELECTRICAL CHARACTERISTICS:

<b>Contact Current Rating, Tested per UL 1977:</b>	18 amperes, 2 contacts energized. 14 amperes, 6 contacts energized. 11 amperes, 15 contacts energized. 10 amperes, 25 contacts energized. 9 amperes, 50 contacts energized.
--	---

See temperature rise curves on page 2 for details.

<b>Initial Contact Resistance:</b>	0.004 ohms maximum.
<b>Insulation Resistance:</b>	5 G ohms.
<b>Proof Voltage:</b>	1000 V r.m.s.
<b>Clearance and Creepage Distance [minimum]:</b>	0.039 inch [1.0mm].
<b>Working Voltage:</b>	300 V r.m.s.

### CLIMATIC CHARACTERISTICS:

<b>Temperature Range:</b>	-55°C to +125°C.
<b>Damp Heat, Steady State:</b>	10 days.



CONTACT VARIANTS  
FACE VIEW OF FEMALE

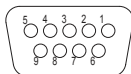

MDX 9

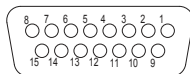

MDX 15

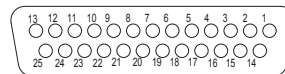

MDX 25

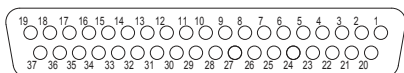

MDX 37

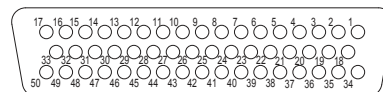

MDX 50

STANDARD SHELL ASSEMBLY

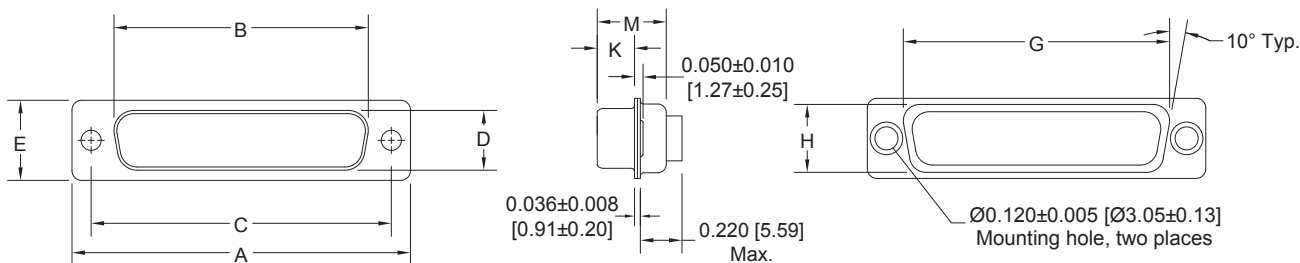

OPTIONAL SHELL ASSEMBLY (0, 02)

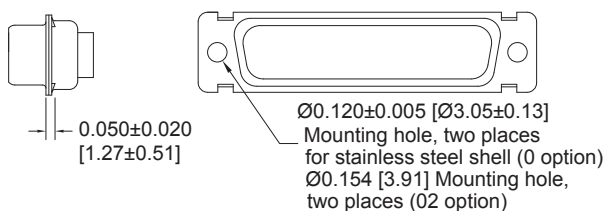

OPTIONAL SHELL ASSEMBLY WITH UNIVERSAL FLOAT MOUNTS (F)

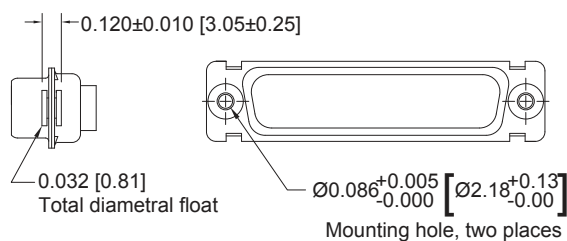

CONNECTOR VARIANT SIZES	A $\pm 0.015$ [0.38]	B $\pm 0.005$ [0.13]	C $\pm 0.005$ [0.13]	D $\pm 0.005$ [0.13]	E $\pm 0.015$ [0.38]	G $\pm 0.010$ [0.25]	H $\pm 0.010$ [0.25]	K $\pm 0.005$ [0.13]	M $\pm 0.010$ [0.25]
9 S	1.213 [30.81]	0.643 [16.33]	0.984 [24.99]	0.311 [7.90]	0.494 [12.55]	0.759 [19.28]	0.422 [10.72]	0.243 [6.17]	0.429 [10.90]
15 S	1.541 [39.14]	0.971 [24.66]	1.312 [33.32]	0.311 [7.90]	0.494 [12.55]	1.083 [27.51]	0.422 [10.72]	0.243 [6.17]	0.429 [10.90]
25 S	2.088 [53.04]	1.511 [38.38]	1.852 [47.04]	0.311 [7.90]	0.494 [12.55]	1.625 [41.28]	0.422 [10.72]	0.243 [6.17]	0.429 [10.90]
37 S	2.729 [69.32]	2.159 [54.84]	2.500 [63.50]	0.311 [7.90]	0.494 [12.55]	2.272 [57.71]	0.422 [10.72]	0.243 [6.17]	0.429 [10.90]
50 S	2.635 [66.93]	2.064 [52.43]	2.406 [61.11]	0.423 [10.74]	0.605 [15.37]	2.178 [55.32]	0.534 [13.56]	0.243 [6.17]	0.429 [10.90]



Positronic  
connectpositronic.com

# INDUSTRIAL QUALITY FIXED CONTACT STANDARD DENSITY D-SUBMINIATURE

D-Sub

## SOLDER CUP TERMINATION CODE 2

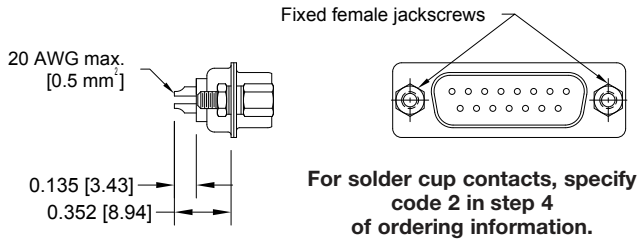

Typical Part Number: MDX15S200T2Z

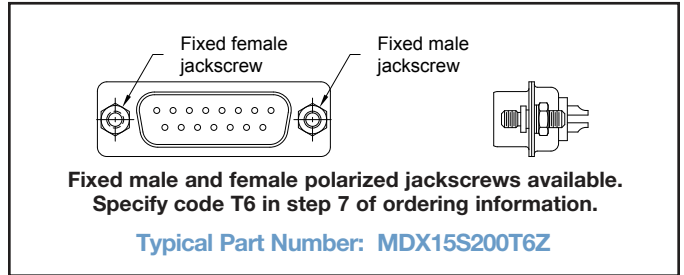

## STRAIGHT PRINTED BOARD MOUNT TERMINATION CODE 3, 32 AND 33

CODE NUMBER	L	ØD
3	0.170 [4.32]	0.028 [0.71]
32	0.375 [9.53]	0.028 [0.71]
33	0.500 [12.70]	0.028 [0.71]

For straight printed board mount contacts, specify code number in step 4 of ordering information.

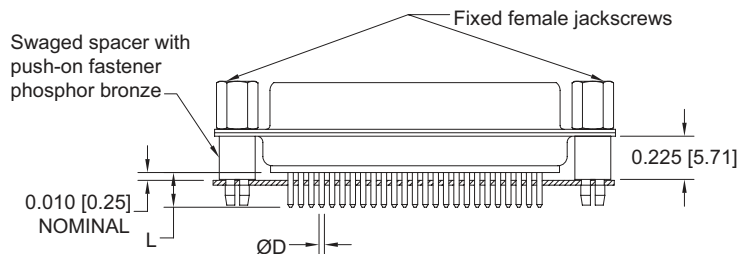

Typical Part Number: MDX25S3S60T0

## RIGHT ANGLE (90°) PRINTED BOARD MOUNT TERMINATION CODE 4, 0.450 [11.43] CONTACT EXTENSION

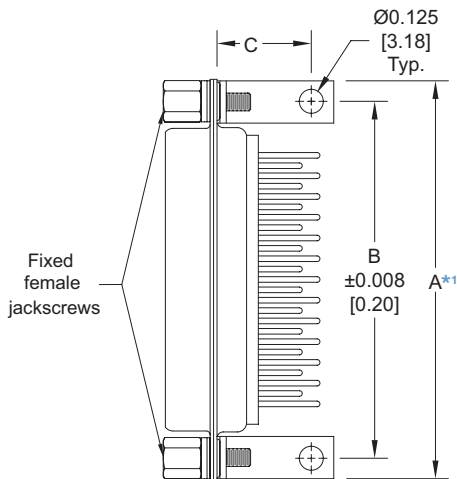

MDX**4**** 0.450 [11.43] CONTACT EXTENSION				
PART NUMBER	A*1	B	C	D
MDX9S4****	1.204 [30.58]	0.984 [24.99]	0.506 [12.85]	0.450 [11.43]
MDX15S4****	1.532 [38.91]	1.312 [33.32]	0.506 [12.85]	0.450 [11.43]
MDX25S4****	2.072 [52.63]	1.852 [47.04]	0.506 [12.85]	0.450 [11.43]
MDX37S4****	2.720 [69.09]	2.500 [63.50]	0.506 [12.85]	0.450 [11.43]
MDX50S4****	2.626 [66.70]	2.406 [61.11]	0.562 [14.27]	0.450 [11.43]

**NOTE:**

\*1 "A" dimension applies for metal angle brackets only. Consult Accessories D-subminiature catalog for "A" dimension when plastic brackets are used.

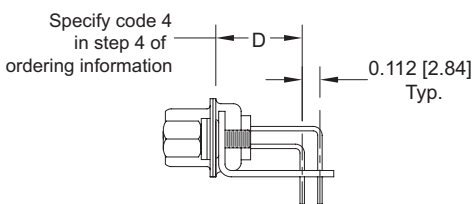

Typical Part Number: MDX25S4B0T20

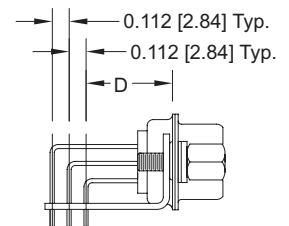
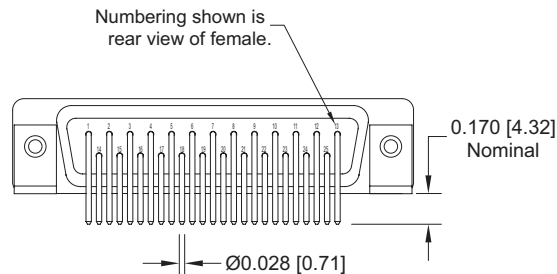

Typical Part Number: MDX50S4B0T20



**RIGHT ANGLE (90°) PRINTED BOARD MOUNT TERMINATION**  
CODE 5, 0.283 [7.19] CONTACT EXTENSION

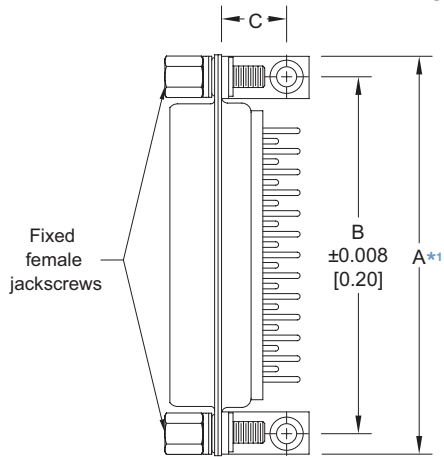

MDX**5**** 0.283 [7.19] CONTACT EXTENSION				
PART NUMBER	A*1	B	C	D
MDX9S5****	1.204 [30.58]	0.984 [24.99]	0.339 [8.61]	0.283 [7.19]
MDX15S5****	1.532 [38.91]	1.312 [33.32]	0.339 [8.61]	0.283 [7.19]
MDX25S5****	2.072 [52.63]	1.852 [47.04]	0.339 [8.61]	0.283 [7.19]
MDX37S5****	2.720 [69.09]	2.500 [63.50]	0.339 [8.61]	0.283 [7.19]
MDX50S5****	2.626 [66.70]	2.406 [61.11]	0.395 [10.03]	0.283 [7.19]

**NOTE:**

\*1 "A" dimension applies for metal angle brackets only. Consult Accessories D-subminiature catalog for "A" dimension when plastic brackets are used.

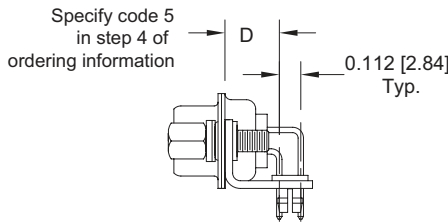

Typical Part Number:  
MDX25S5R4NT2X

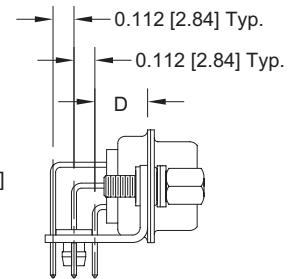
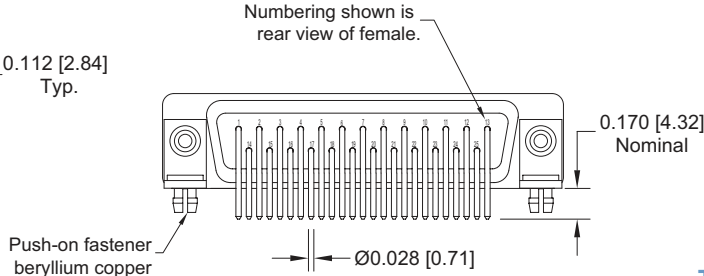

Typical Part Number:  
MDX50S5R4NT2X

**RIGHT ANGLE (90°) AND STRAIGHT PRINTED BOARD CONTACT HOLE PATTERN**

MOUNT CONNECTOR WITH MATING FACE POSITIONED TO FOLLOW DIRECTION OF ARROW.

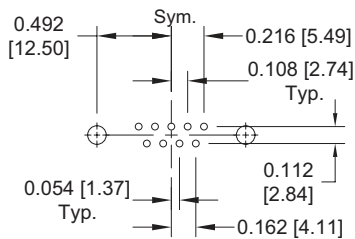

MDX9

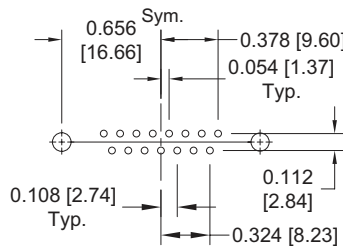

MDX15

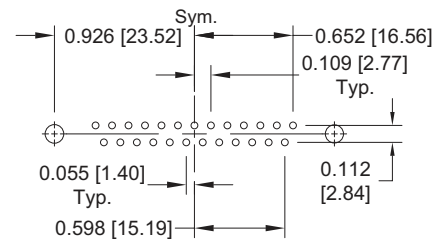

MDX25

**SUGGESTED PRINTED BOARD HOLE SIZES:**

Suggest 0.045 [1.14] Ø hole for contact termination positions.

Suggest 0.123 ±0.003 [3.12 ±0.08] Ø hole for mounting connector with push-on fasteners.

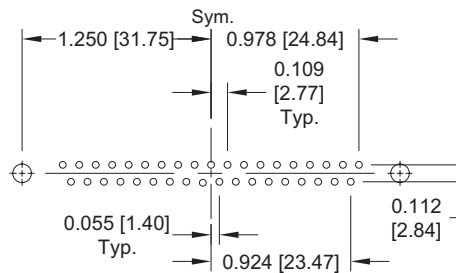

MDX37

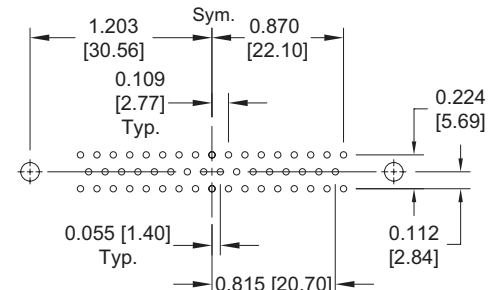

MDX50



## ORDERING INFORMATION - CODE NUMBERING SYSTEM

Specify Complete Connector By Selecting An Option From Step 1 Through 8

STEP	1	2	3	4	5	6	7	8	9	10
EXAMPLE	MDX	25	S	5	R7	N	T6	X	/AA	-14
<b>STEP 1 - BASIC SERIES</b> MDX series.										<b>STEP 10 - SPECIAL OPTIONS</b> -14 - 0.000030 [0.76µ] gold over nickel. -15 - 0.000050 [1.27µ] gold over nickel. <b>CONTACT TECHNICAL SALES FOR SPECIAL OPTIONS</b>
<b>STEP 2 - CONNECTOR VARIANTS</b> 9, 15, 25, 37, 50										
<b>STEP 3 - CONNECTOR GENDER</b> S - Female - Industrial Level PosiBand closed entry contacts										
<b>STEP 4 - CONTACT TERMINATION TYPE</b> 2 - Solder cup. 3 - Solder, Straight Printed Board Mount with 0.170 [4.32] Tail Length. *4 32 - Solder, Straight Printed Board Mount with 0.375 [9.52] Tail Length. *4 33 - Solder, Straight Printed Board Mount with 0.500 [12.70] tail length. *4 4 - Solder, Right Angle (90°) Printed Board Mount with 0.450 [11.43] Contact Extension. 5 - Solder, Right Angle (90°) Printed Board Mount with 0.283 [7.19] Contact Extension.										
<b>*1 STEP 5 - MOUNTING STYLE</b> 0 - Mounting Hole, 0.120 [3.05] Ø. 02 - Mounting Hole, 0.154 [3.91] Ø. B - Bracket, Mounting, Right Angle (90°) Metal. B3 - Bracket, Mounting, Right Angle (90°) Metal with Cross Bar. B7 - Bracket, Mounting, Right Angle (90°) Plastic. B8 - Bracket, Mounting, Right Angle (90°) Plastic with Cross Bar. F - Float Mounts, Universal. P - Threaded Post, Brass, 0.225 [5.71] Length. P2 - Threaded Post, Nylon, 0.225 [5.71] Length. R - Bracket, Mounting, Right Angle (90°) Metal, Swaged to Connector with 4-40 Thread Fixed Female Jackscrews. R2 - Bracket, Mounting, Right Angle (90°) Metal, Swaged to Connector with 4-40 Thread Fixed Female Jackscrews with Cross Bar. R3 - Bracket, Mounting, Right Angle (90°) Metal, Swaged to Connector with 0.120 [3.05] Ø Mounting Hole. R4 - Bracket, Mounting, Right Angle (90°) Metal, Swaged to Connector with 4-40 Threads. R5 - Bracket, Mounting, Right Angle (90°) Metal, Swaged to Connector with 4-40 Locknut. R6 - Bracket, Mounting, Right Angle (90°) Metal, Swaged to Connector with 0.120 [3.05] Ø Mounting Hole with Cross Bar. R7 - Bracket, Mounting, Right Angle (90°) Metal, Swaged to Connector with 4-40 Threads with Cross Bar. R8 - Bracket, Mounting, Right Angle (90°) Metal, Swaged to Connector with 4-40 Locknut with Cross Bar. S - Swaged Spacer, 4-40 Threads, 0.225 [5.71] Length. S2 - Swaged Spacer, 4-40 Threads, 0.125 [3.18] Length. S5 - Swaged Locknut, 4-40 Threads. S6 - Swaged Spacer with Push-on Fastener, 4-40 Threads, 0.225 [5.71] Length. S7 - Swaged Spacer with Push-on Fastener for use with Ferrite Inductor, 4-40 Threads, 0.375 [9.53] Length.										
<b>STEP 8 - Shell Options</b> 0 - Zinc plated, with chromate seal. S - Stainless steel, passivated. X - Tin plated. Z - Tin plated and dimpled (male connectors only).										
<b>*1 STEP 7 - LOCKING AND POLARIZING SYSTEMS</b> 0 - None. *3 V3 - Lock Tab, connector front panel mounted. *3 V5 - Lock Tab, connector rear panel mounted. *3 VL - Lock Lever, used with Hoods only. T - Fixed Female Jackscrews. T2 - Fixed Female Jackscrews. T6 - Fixed Male and Female Polarized Jackscrews. E - Rotating Male Jackscrews. E2 - Rotating Male Screw Locks. E3 - Rotating Male with Internal Hex for 3/32 Hex Drives E6 - Rotating Male and Female Polarized Jackscrews.										
<b>*1 STEP 6 - HOODS AND PUSH-ON FASTENERS</b> 0 - None. J - Hood, Top Opening, Plastic. L - Hood, Side Opening, Plastic. Y - Hood, Top Opening, Plastic with Rotating Male Jackscrews. Available in size 50 only. Y6 - Hood, Top Opening, Plastic with Rotating Male and Female Polarized Jackscrews. Available in size 50 only. Z - Hood, Top or Side Opening, Robust and Extended Height, Composite and Plastic with Rotating Male Jackscrews. Available in size 9, 15, 25, 37, and 50 only. H - Hood, Top Opening, Metal. Available in size 15, 25, 37, and 50 only. G - Hood, EMI/RFI, Die Cast Zinc. Available in size 9, 15, 25, 37, and 50 only. AN - Lightweight Aluminum Hood, nickel finish. AC - Lightweight Aluminum Hood, no finish. W - Hood, Top or Side Opening, Plastic. Available in size 9, 15, and 25 only. N - Push-on fastener for right angle (90°) mounting brackets. *2 F - Ferrite inductor. *2 Q - Ferrite inductor for use with push-on fastener and right angle (90°) mounting brackets.										
<b>STEP 9 - ENVIRONMENTAL COMPLIANCE OPTIONS</b> /AA - RoHS Compliant <b>NOTE:</b> If compliance to environmental legislation is not required, this step will not be used. Example: MDX25S5R7NT6X										

MDX SERIES



Size 20 Contacts, Fixed  
European Standard  
Printed Circuit Board Layout  
IEC Publication 60807-2  
Performance Level Two

UL Recognized  
File #E49351

CSA Recognized  
File #LR54219

Telecommunication  
UL File #E140980



Euro-D series connectors are professional quality connectors recommended for use in sheltered, non-corrosive indoor or outdoor environments having normal ventilation, but without temperature or humidity controls. These fixed contact connectors meet the dimensional and performance requirements of IEC 60807-2, Performance Level Two.

Euro-D series connectors utilize precision machined contacts which are fixed within the connector body. The female contact is an open entry design contact, precision machined of high tensile phosphor bronze.

Six standard connector variants are offered in

arrangements of 9, 15, 25, 29, 37 and 50 contacts. Each Euro-D connector variant is available with contact terminations for solder cup, wrap post and straight and right angle (90°) printed board mount terminations per standard European metric footprints. Euro-D series connectors are mateable and compatible with all D-subminiature connectors conforming to IEC 60807-2, IEC 60807-3 and MIL-DTL-24308.

A wide assortment of printed board mounting hardware, cable support hoods and locking systems is available from stock.

## EURO-D SERIES TECHNICAL CHARACTERISTICS

### MATERIALS AND FINISHES:

<b>Insulator:</b>	Nylon resin, UL 94V-0, black color.
<b>Contacts:</b>	Precision machined copper alloy.
<b>Contact Plating:</b>	Professional performance Gold flash over nickel plate. Other finishes available upon request.
<b>Shells:</b>	Steel with tin plate; zinc plate with chromate seal, stainless steel passivated. Other materials and finishes available upon request.
<b>Mounting Spacers and Brackets:</b>	Nylon; copper alloy or steel with zinc plate and chromate seal or tin plate; phosphor bronze with tin plate; stainless steel, passivated; polyester.
<b>Push-On Fasteners:</b>	Phosphor bronze or beryllium copper with tin plate.
<b>Jackscrew Systems:</b>	Brass or steel with zinc plate and chromate seal or clear zinc plate or tin plate; stainless steel, passivated.
<b>Vibration Lock Systems:</b>	Slide lock and lock tabs, steel with nickel plate.
<b>Hoods:</b>	Composite and plastic, UL 94V-0; brass or steel with zinc plate and chromate seal. Aluminum; aluminum with electroless nickel plate. For aluminum hoods, zinc content is 1% maximum. Die cast zinc.

Low magnetic versions are available, contact Technical Sales.

### MECHANICAL CHARACTERISTICS:

<b>Fixed Contacts:</b>	Size 20 contact, male - 0.040 inch [1.02mm] mating diameter. Female contact - rugged open entry design.
<b>Contact Retention In Insulator:</b>	6 lbs. [27N]
<b>Resistance To Solder Iron Heat:</b>	500°F [260°C] for 10 seconds duration per IEC 60512-6.

<b>Contact Terminations:</b>	Solder cup contacts - 0.042 inch [1.06mm] minimum hole diameter for 20 AWG [0.5mm <sup>2</sup> ] wire maximum. Straight Printed Board Mount - 0.024 inch [0.61mm] termination diameter. Right Angle (90°) Printed Board Mount - 0.024 inch [0.61mm] termination diameter for European Metric Footprints.
<b>Shells:</b>	Male shells may be dimpled for EMI/ESD ground paths.
<b>Polarization:</b>	Trapezoidally shaped shells and polarized jackscrews.
<b>Mounting To Angle Brackets:</b>	Jackscrews and riveted fasteners with a 0.120 inch [3.05mm] clearance hole, and threaded riveted fasteners with 4-40 threads and polyester lock inserts.
<b>Mounting To Printed Board:</b>	Rapid installation push-on fasteners and threaded posts.
<b>Locking Systems:</b>	Jackscrews and vibration locking systems.
<b>Mechanical Operations:</b>	500 operations minimum per IEC 60512-5.

### ELECTRICAL CHARACTERISTICS:

<b>Contact Current Rating:</b>	7.5 amperes nominal.
<b>Initial Contact Resistance:</b>	0.008 ohms maximum.
<b>Insulation Resistance:</b>	5 G ohms.
<b>Proof Voltage:</b>	1000 V r.m.s.
<b>Clearance and Creepage Distance [minimum]:</b>	0.039 inch [1.0mm].
<b>Working Voltage:</b>	300 V r.m.s.

### CLIMATIC CHARACTERISTICS:

<b>Temperature Range:</b>	-55°C to +125°C.
<b>Damp Heat, Steady State:</b>	10 days.



Positronic  
connectpositronic.com

# PROFESSIONAL QUALITY FIXED CONTACT STANDARD DENSITY D-SUBMINIATURE

D-Sub

## CONTACT VARIANTS FACE VIEW OF MALE OR REAR VIEW OF FEMALE

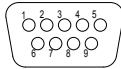

ED 9

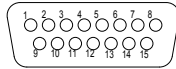

ED 15

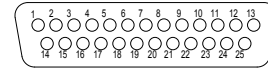

ED 25

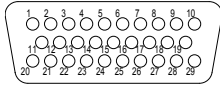

ED 29

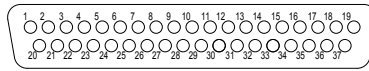

ED 37

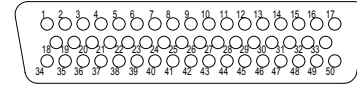

ED 50

## STANDARD SHELL ASSEMBLY

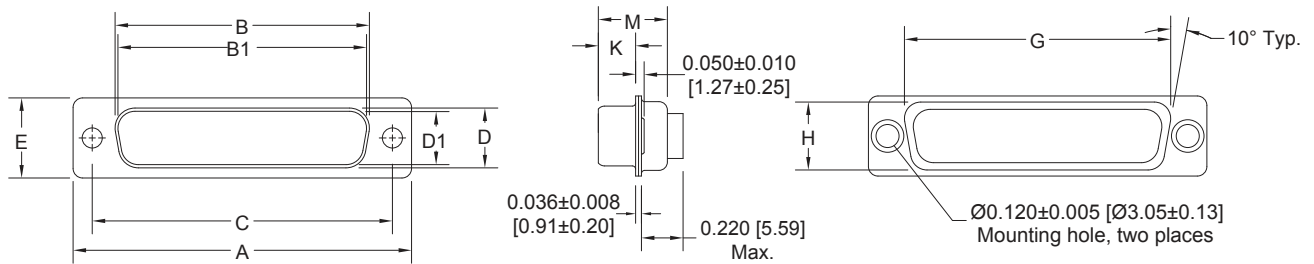

### OPTIONAL SHELL ASSEMBLY (0, 02)

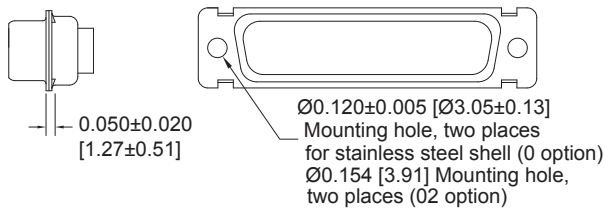

### OPTIONAL SHELL ASSEMBLY WITH UNIVERSAL FLOAT MOUNTS (F)

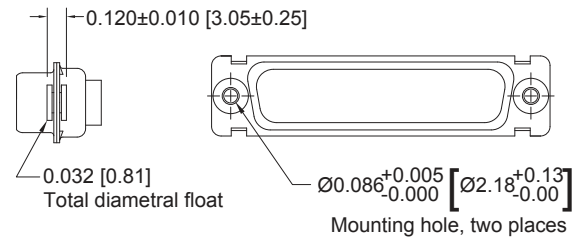

CONNECTOR VARIANT SIZES	A ±0.015 [0.38]	B ±0.005 [0.13]	B1 ±0.005 [0.13]	C ±0.005 [0.13]	D ±0.005 [0.13]	D1 ±0.005 [0.13]	E ±0.015 [0.38]	G ±0.010 [0.25]	H ±0.010 [0.25]	K ±0.005 [0.13]	M ±0.010 [0.25]
9 M	1.213 [30.81]		0.666 [16.92]	0.984 [24.99]		0.329 [8.36]	0.494 [12.55]	0.759 [19.28]	0.422 [10.72]	0.233 [5.92]	0.422 [10.72]
9 F	1.213 [30.81]	0.643 [16.33]		0.984 [24.99]	0.311 [7.90]		0.494 [12.55]	0.759 [19.28]	0.422 [10.72]	0.243 [6.17]	0.429 [10.90]
15 M	1.541 [39.14]		0.994 [25.25]	1.312 [33.32]		0.329 [8.36]	0.494 [12.55]	1.083 [27.51]	0.422 [10.72]	0.233 [5.92]	0.422 [10.72]
15 F	1.541 [39.14]	0.971 [24.66]		1.312 [33.32]	0.311 [7.90]		0.494 [12.55]	1.083 [27.51]	0.422 [10.72]	0.243 [6.17]	0.429 [10.90]
25 M	2.088 [53.04]		1.534 [38.96]	1.852 [47.04]		0.329 [8.36]	0.494 [12.55]	1.625 [41.28]	0.422 [10.72]	0.230 [5.84]	0.426 [10.82]
25 F	2.088 [53.04]	1.511 [38.38]		1.852 [47.04]	0.311 [7.90]		0.494 [12.55]	1.625 [41.28]	0.422 [10.72]	0.243 [6.17]	0.429 [10.90]
29 M	1.770 [44.96]		1.274 [32.36]	1.534 [38.96]		0.450 [11.43]	0.605 [15.37]	1.322 [33.58]	0.539 [13.69]	0.230 [5.84]	0.426 [10.82]
29 F	1.770 [44.96]	1.251 [31.78]		1.534 [38.96]	0.431 [10.95]		0.605 [15.37]	1.322 [33.58]	0.539 [13.69]	0.237 [6.02]	0.429 [10.90]
37 M	2.729 [69.32]		2.182 [55.42]	2.500 [63.50]		0.329 [8.36]	0.494 [12.55]	2.272 [57.71]	0.422 [10.72]	0.230 [5.84]	0.426 [10.82]
37 F	2.729 [69.32]	2.159 [54.84]		2.500 [63.50]	0.311 [7.90]		0.494 [12.55]	2.272 [57.71]	0.422 [10.72]	0.243 [6.17]	0.429 [10.90]
50 M	2.635 [66.93]		2.079 [52.81]	2.406 [61.11]		0.441 [11.20]	0.605 [15.37]	2.178 [55.32]	0.534 [13.56]	0.230 [5.84]	0.426 [10.82]
50 F	2.635 [66.93]	2.064 [52.43]		2.406 [61.11]	0.423 [10.74]		0.605 [15.37]	2.178 [55.32]	0.534 [13.56]	0.243 [6.17]	0.429 [10.90]





**SOLDER CUP TERMINATION  
CODE 2**

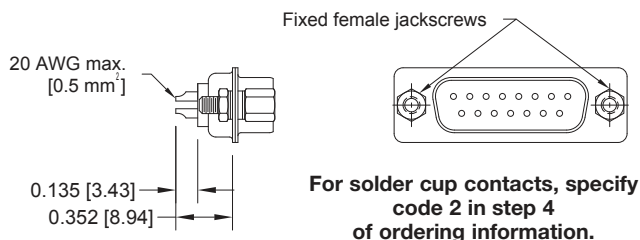

Typical Part Number: ED15M200T2Z

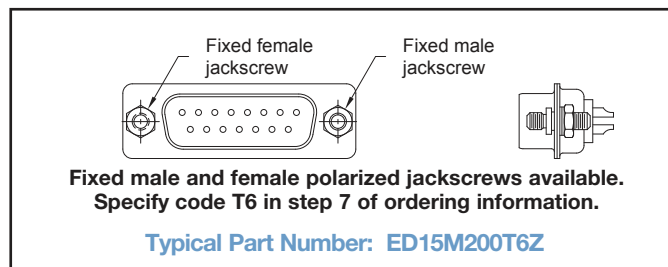

**STRAIGHT PRINTED BOARD MOUNT TERMINATION  
CODE 36**

CODE NUMBER	L	ØD
36	0.236 [5.99]	0.024 [0.61]

For straight printed board mount contacts, specify code number in step 4 of ordering information.

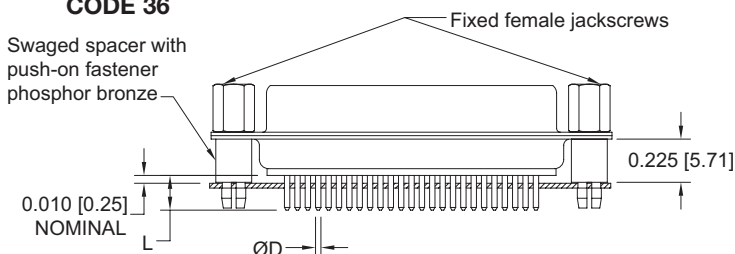

Typical Part Number: ED25F36S60T0

**RIGHT ANGLE (90°) PRINTED BOARD MOUNT TERMINATION  
CODE 42 AND 52, 0.370 [9.40] CONTACT EXTENSION**

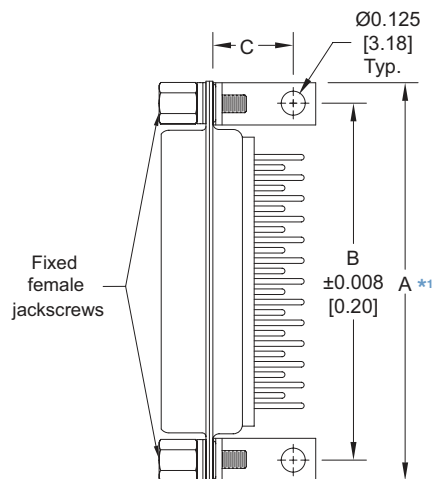

ED**(42 or 52)**** 0.370 [9.40] CONTACT EXTENSION				
PART NUMBER	A*1	B	C	D
ED9*(42 or 52)****	1.204 [30.58]	0.984 [24.99]	0.420 [10.67]	0.370 [9.40]
ED15*(42 or 52)****	1.532 [38.91]	1.312 [33.32]	0.420 [10.67]	0.370 [9.40]
ED25*(42 or 52)****	2.072 [52.63]	1.852 [47.04]	0.420 [10.67]	0.370 [9.40]
ED29*(42 or 52)****	1.754 [44.55]	1.534 [38.96]	0.470 [11.94]	0.370 [9.40]
ED37*(42 or 52)****	2.720 [69.09]	2.500 [63.50]	0.420 [10.67]	0.370 [9.40]
ED50*(42 or 52)****	2.626 [66.70]	2.406 [61.11]	0.470 [11.94]	0.370 [9.40]

**NOTE:**

\*1 "A" dimension applies for metal angle brackets only. Consult Accessories D-subminiature catalog for "A" dimension when plastic brackets are used.

Specify code 42 or 52 in step 4 of ordering information

D

0.100 [2.54] Typ. for code 42 contacts

0.112 [2.84] Typ. for code 52 contacts

Typical Part Number: ED25M42B0T2X

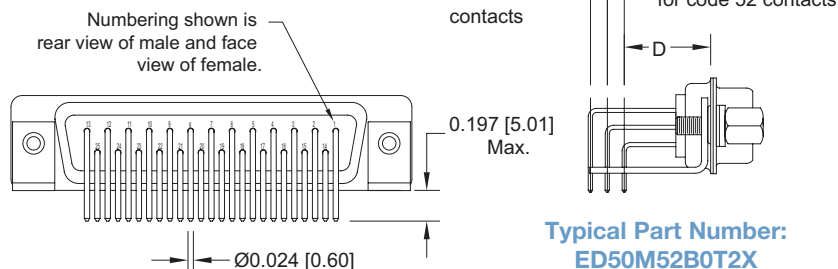



Positronic  
connectpositronic.com

# PROFESSIONAL QUALITY FIXED CONTACT STANDARD DENSITY D-SUBMINIATURE

D-Sub

## RIGHT ANGLE (90°) PRINTED BOARD MOUNT TERMINATION CODE 44, 0.370 [9.40] CONTACT EXTENSION

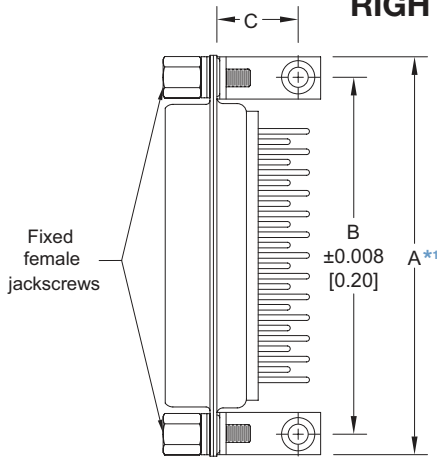

ED**44**** 0.370 [9.40] CONTACT EXTENSION				
PART NUMBER	A*1	B	C	D
ED9*44****	1.204 [30.58]	0.984 [24.99]	0.420 [10.67]	0.370 [9.40]
ED15*44****	1.532 [38.91]	1.312 [33.32]	0.420 [10.67]	0.370 [9.40]
ED25*44****	2.072 [52.63]	1.852 [47.04]	0.420 [10.67]	0.370 [9.40]
ED29*44****	1.754 [44.55]	1.534 [38.96]	0.470 [11.94]	0.370 [9.40]
ED37*44****	2.720 [69.09]	2.500 [63.50]	0.420 [10.67]	0.370 [9.40]
ED50*44****	2.626 [66.70]	2.406 [61.11]	0.470 [11.94]	0.370 [9.40]

**NOTE:**

\*1 "A" dimension applies for metal angle brackets only. Consult Accessories D-subminiature catalog for "A" dimension when plastic brackets are used.

Specify code 44 in step 4 of ordering information

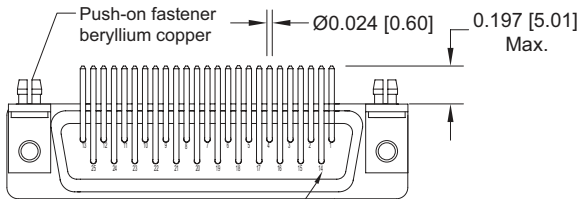
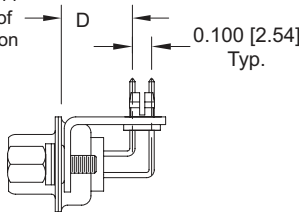

Numbering shown is rear view of male and face view of female.

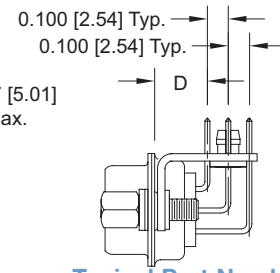

## RIGHT ANGLE (90°) AND STRAIGHT PRINTED BOARD CONTACT HOLE PATTERN

FOR CODE 42 AND 52 CONTACTS, MOUNT CONNECTOR WITH MATING FACE POSITIONED TO FOLLOW DIRECTION OF ARROW. FOR CODE 44 CONTACTS, MOUNT CONNECTOR WITH MATING FACE POSITIONED TO OPPOSE DIRECTION OF ARROW.

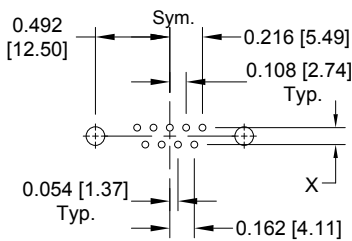

ED9

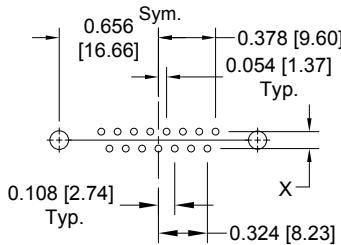

ED15

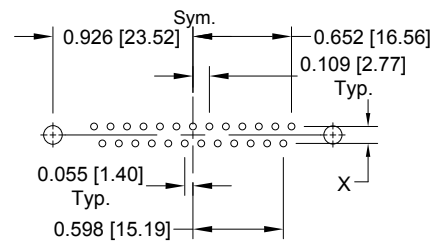

ED25

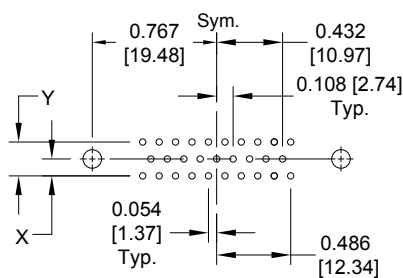

ED29

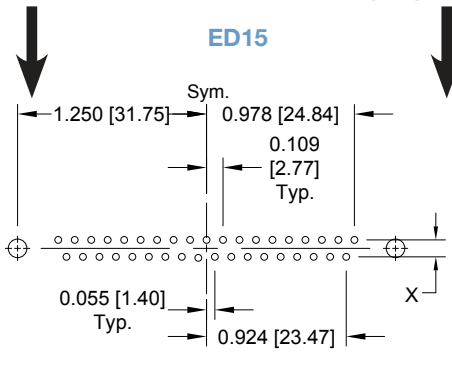

ED37

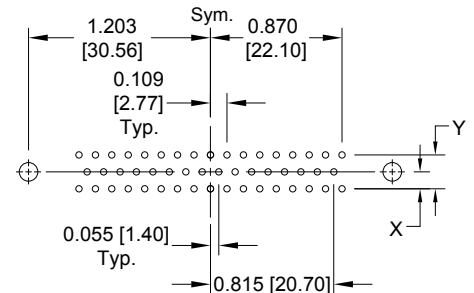

ED50

**SUGGESTED PRINTED BOARD HOLE SIZES:**

Suggest 0.040 [1.02] Ø hole for contact termination positions.  
Suggest 0.123 ±0.003 [3.12 ±0.08] Ø hole for mounting connector with push-on fasteners.

CODE NUMBER	X	Y
36	0.112 [2.84]	0.224 [5.69]
42	0.100 [2.54]	0.200 [5.08]
44	0.100 [2.54]	0.200 [5.08]
52	0.112 [2.84]	0.224 [5.69]



## ORDERING INFORMATION - CODE NUMBERING SYSTEM

Specify Complete Connector By Selecting An Option From Step 1 Through 8

STEP	1	2	3	4	5	6	7	8	9	10
EXAMPLE	ED	9	M	36	0	0	0	0	/AA	-14
<b>STEP 1 - BASIC SERIES</b> ED series.										<b>STEP 10 - SPECIAL OPTIONS</b> -14 - 0.000030 [0.76µ] gold over nickel. -15 - 0.000050 [1.27µ] gold over nickel. <b>CONTACT TECHNICAL SALES FOR SPECIAL OPTIONS</b>
<b>STEP 2 - CONNECTOR VARIANTS</b> 9, 15, 25, 29, 37, 50										
<b>STEP 3 - CONNECTOR GENDER</b> M - Male F - Female										
<b>STEP 4 - CONTACT TERMINATION TYPE</b> 2 - Solder cup. 36 - Solder, Straight Printed Board Mount with 0.236 [5.99] Tail Length. 42 - Solder, Right Angle (90°) Printed Board Mount with 0.370 [9.40] Contact Extension. 44 - Solder, Inverted Right Angle (90°) Printed Board Mount with 0.370 [9.40] Contact Extension. 52 - Solder, Right Angle (90°) Printed Board Mount with 0.370 [9.40] Contact Extension.										
<b>*1 STEP 5 - MOUNTING STYLE</b> 0 - Mounting Hole, 0.120 [3.05] Ø. 02 - Mounting Hole, 0.154 [3.91] Ø. B - Bracket, Mounting, Right Angle (90°) Metal. B3 - Bracket, Mounting, Right Angle (90°) Metal with Cross Bar. B7 - Bracket, Mounting, Right Angle (90°) Plastic. B8 - Bracket, Mounting, Right Angle (90°) Plastic with Cross Bar. F - Float Mounts, Universal. P - Threaded Post, Brass, 0.225 [5.71] Length. P2 - Threaded Post, Nylon, 0.225 [5.71] Length. R - Bracket, Mounting, Right Angle (90°) Metal, Swaged to Connector with 4-40 Thread Fixed Female Jackscrews. R2 - Bracket, Mounting, Right Angle (90°) Metal, Swaged to Connector with 4-40 Thread Fixed Female Jackscrews with Cross Bar. R3 - Bracket, Mounting, Right Angle (90°) Metal, Swaged to Connector with 0.120 [3.05] Ø Mounting Hole. R4 - Bracket, Mounting, Right Angle (90°) Metal, Swaged to Connector with 4-40 Threads. R5 - Bracket, Mounting, Right Angle (90°) Metal, Swaged to Connector with 4-40 Locknut. R6 - Bracket, Mounting, Right Angle (90°) Metal, Swaged to Connector with 0.120 [3.05] Ø Mounting Hole with Cross Bar. R7 - Bracket, Mounting, Right Angle (90°) Metal, Swaged to Connector with 4-40 Threads with Cross Bar. R8 - Bracket, Mounting, Right Angle (90°) Metal, Swaged to Connector with 4-40 Locknut with Cross Bar. S - Swaged Spacer, 4-40 Threads, 0.225 [5.71] Length. S2 - Swaged Spacer, 4-40 Threads, 0.125 [3.18] Length. S5 - Swaged Locknut, 4-40 Threads. S6 - Swaged Spacer with Push-on Fastener, 4-40 Threads, 0.225 [5.71] Length. S7 - Swaged Spacer with Push-on Fastener for use with Ferrite Inductor, 4-40 Threads, 0.375 [9.53] Length.										
										<b>STEP 9 - ENVIRONMENTAL COMPLIANCE OPTIONS</b> /AA - RoHS Compliant  <b>NOTE:</b> If compliance to environmental legislation is not required, this step will not be used. Example: ED9M360000
										<b>STEP 8 - Shell Options</b> 0 - Zinc plated with chromate seal. *4 S - Stainless steel, passivated. X - Tin plated. Z - Tin plated and dimpled (male connectors only).
										<b>*1 STEP 7 - LOCKING AND POLARIZING SYSTEMS</b> 0 - None. *3 V3 - Lock Tab, connector front panel mounted. *3 V5 - Lock Tab, connector rear panel mounted. *3 VL - Lock Lever, used with Hoods only. T - Fixed Female Jackscrews. T2 - Fixed Female Jackscrews. T6 - Fixed Male and Female Polarized Jackscrews. E - Rotating Male Jackscrews. E2 - Rotating Male Screw Locks. E3 - Rotating Male with Internal Hex for 3/32 Hex Drives E6 - Rotating Male and Female Polarized Jackscrews.
										<b>*1 STEP 6 - HOODS AND PUSH-ON FASTENERS</b> 0 - None. J - Hood, Top Opening, Plastic. L - Hood, Side Opening, Plastic. Y - Hood, Top Opening, Plastic with Rotating Male Jackscrews. Available in size 50 only. Y6 - Hood, Top Opening, Plastic with Rotating Male and Female Polarized Jackscrews. Available in size 50 only. Z - Hood, Top or Side Opening, Robust and Extended Height, Composite and Plastic with Rotating Male Jackscrews. Available in size 9, 15, 25, 37, and 50 only. H - Hood, Top Opening, Metal. Available in size 15, 25, 37, and 50 only. G - Hood, EMI/RFI, Die Cast Zinc. Available in size 9, 15, 25, 37, and 50 only. *5 AN - Lightweight Aluminum Hood, nickel finish. *5 AC - Lightweight Aluminum Hood, no finish. W - Hood, Top or Side Opening, Plastic. Available in size 9, 15, and 25 only. N - Push-on Fastener, for Right Angle (90°) Mounting Brackets. *2 F - Ferrite inductor. *2 Q - Ferrite inductor for use with Push-on Fastener and Right Angle (90°) Mounting Brackets.

\*1 For additional information on accessories listed in steps 5, 6 and 7, see Accessory Catalog.

\*2 Ferrite inductor is available on contact types 36 only. For more information on ferrite inductors, see page 7.

\*3 VL, V3 and V5 locking systems are not available for connector variants 37 and 50. Jackscrews are highly recommended to minimize damage to contacts on variants with high mating forces.

\*4 For stainless steel dimpled male versions contact Technical Sales.

\*5 AN and AC hood are not available for connector variant 29. Consult Technical Sales for availability.



Positronic  
connectpositronic.com

# PROFESSIONAL QUALITY REMOVABLE CONTACT STANDARD DENSITY D-SUBMINIATURE

D-Sub

**Size 20 Contacts,  
Removable**

**IEC Publication 60807-3  
Performance Level Two**

UL Recognized  
File #E49351

CSA Recognized  
File #LR54219

Telecommunication  
UL File #E140980

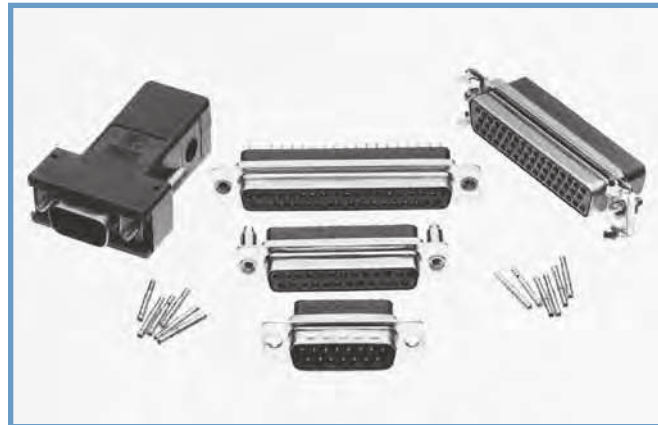

Soli-D series connectors are professional quality connectors recommended for use in sheltered, non-corrosive indoor or outdoor environments having normal ventilation, but without temperature or humidity controls. This crimp removable contact connector will meet the Performance Level Two requirements of IEC 60807-3.

Soli-D series connectors utilize precision machined contacts with closed barrel, crimp terminations. The female contact features a rugged open entry design. Other contact terminations such as solder cup and

printed board terminations are also available. The removable contact feature provides for rapid assembly and permits contact repairs or wiring changes.

Five standard contact variants are offered in arrangements of 9, 15, 25, 37 and 50 contacts. Soli-D series connectors are mateable and compatible with all D-subminiature connectors conforming to IEC 60807-2, IEC 60807-3 and MIL-DTL-24308.

A wide assortment of cable support hoods and locking systems is available from stock.

## SOLI-D SERIES TECHNICAL CHARACTERISTICS

### MATERIALS AND FINISHES:

<b>Insulator:</b>	Glass filled nylon resin, UL 94V-0, black color.
<b>Contacts:</b>	Precision machined copper alloy.
<b>Contact Plating:</b>	Professional performance - gold flash over nickel plate. Other finishes available upon request.
<b>Shells:</b>	Steel with tin plate; zinc plate with chromate seal, stainless steel passivated. Other materials and finishes available upon request.
<b>Mounting Spacers:</b>	Nylon; copper alloy or steel with zinc plate and chromate seal or tin plate; phosphor bronze with tin plate; stainless steel, passivated.
<b>Push-On Fasteners:</b>	Phosphor bronze with tin plate.
<b>Jackscrew Systems:</b>	Brass or steel with zinc plate and chromate seal or clear zinc plate or tin plate; stainless steel, passivated.
<b>Vibration Lock Systems:</b>	Slide lock and lock tabs, steel with nickel plate.
<b>Hoods:</b>	Composite and plastic, UL 94V-0; brass or steel with zinc plate and chromate seal. Aluminum; aluminum with electroless nickel plate. For aluminum hoods, zinc content is 1% maximum. Die cast zinc.

Low magnetic versions are available, contact Technical Sales.

### CLIMATIC CHARACTERISTICS:

<b>Temperature Range:</b>	-55°C to +125°C.
<b>Damp Heat, Steady State:</b>	10 days.

### MECHANICAL CHARACTERISTICS:

<b>Removable Contacts:</b>	Insert contact to rear face of insulator and release from rear face of insulator. Size 20 contacts, male - 0.040 inch [1.02mm] mating diameter. Female - rugged open entry design.
<b>Contact Retention In Insulator:</b>	6 lbs. [27 N].
<b>Contact Terminations:</b>	Closed barrel crimp, wire sizes 18 AWG [1.0mm <sup>2</sup> ] through 32 AWG [0.03mm <sup>2</sup> ]. Straight printed board mount terminations.
<b>Shells:</b>	Male shells may be dimpled for EMI/ESD ground paths.
<b>Polarization:</b>	Trapezoidally shaped shells and polarized jackscrews.
<b>Printed Board Mount:</b>	Rapid installation push-on fasteners.
<b>Locking Systems:</b>	Jackscrews and vibration locking systems.
<b>Mechanical Operations:</b>	500 operations minimum per IEC 60512-5.

### ELECTRICAL CHARACTERISTICS:

<b>Contact Current Rating:</b>	7.5 amperes nominal.
<b>Initial Contact Resistance:</b>	0.008 ohms maximum.
<b>Proof Voltage:</b>	1000 V r.m.s.
<b>Insulation Resistance:</b>	5 G ohms.
<b>Clearance and Creepage Distance [minimum]:</b>	0.039 inch [1.0mm].
<b>Working Voltage:</b>	300 V r.m.s.



**CONTACT VARIANTS**  
FACE VIEW OF MALE OR REAR VIEW OF FEMALE

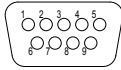

SD 9

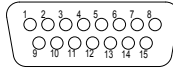

SD 15

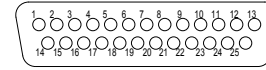

SD 25

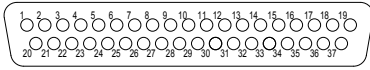

SD 37

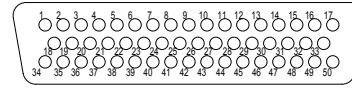

SD 50

**STANDARD SHELL ASSEMBLY**

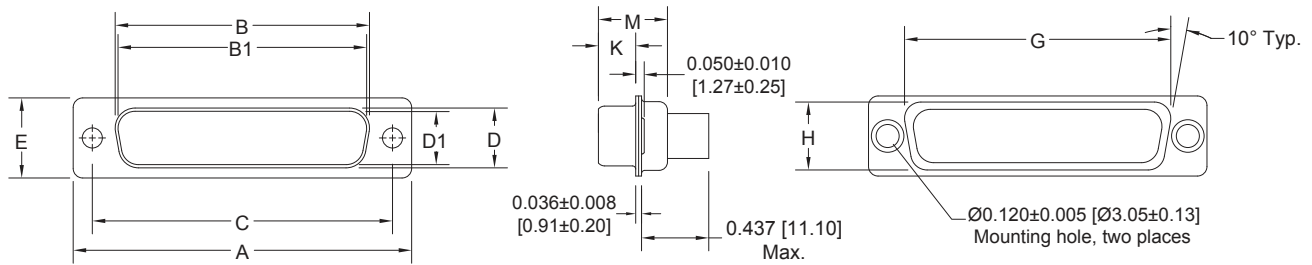

**OPTIONAL SHELL ASSEMBLY (0, 02)**

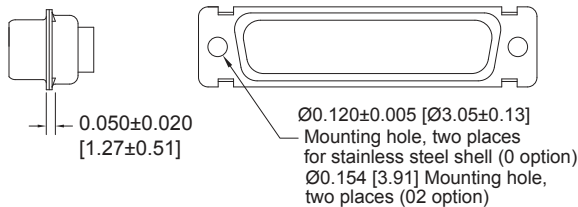

**OPTIONAL SHELL ASSEMBLY WITH UNIVERSAL FLOAT MOUNTS (F)**

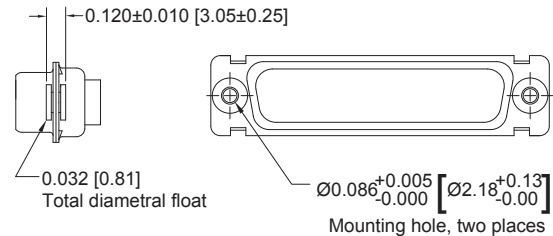

CONNECTOR VARIANT SIZES	A ±0.015 [0.38]	B ±0.005 [0.13]	B1 ±0.005 [0.13]	C ±0.005 [0.13]	D ±0.005 [0.13]	D1 ±0.005 [0.13]	E ±0.015 [0.38]	G ±0.010 [0.25]	H ±0.010 [0.25]	K ±0.005 [0.13]	M ±0.010 [0.25]
SD 9 M	1.213 [30.81]		0.666 [16.92]	0.984 [24.99]		0.329 [8.36]	0.494 [12.55]	0.759 [19.28]	0.422 [10.72]	0.233 [5.92]	0.422 [10.72]
SD 9 F	1.213 [30.81]	0.643 [16.33]		0.984 [24.99]	0.311 [7.90]		0.494 [12.55]	0.759 [19.28]	0.422 [10.72]	0.243 [6.17]	0.429 [10.90]
SD 15 M	1.541 [39.14]		0.994 [25.25]	1.312 [33.32]		0.329 [8.36]	0.494 [12.55]	1.083 [27.51]	0.422 [10.72]	0.233 [5.92]	0.422 [10.72]
SD 15 F	1.541 [39.14]	0.971 [24.66]		1.312 [33.32]	0.311 [7.90]		0.494 [12.55]	1.083 [27.51]	0.422 [10.72]	0.243 [6.17]	0.429 [10.90]
SD 25 M	2.088 [53.04]		1.534 [38.96]	1.852 [47.04]		0.329 [8.36]	0.494 [12.55]	1.625 [41.28]	0.422 [10.72]	0.230 [5.84]	0.426 [10.82]
SD 25 F	2.088 [53.04]	1.511 [38.38]		1.852 [47.04]	0.311 [7.90]		0.494 [12.55]	1.625 [41.28]	0.422 [10.72]	0.243 [6.17]	0.429 [10.90]
SD 37 M	2.729 [69.32]		2.182 [55.42]	2.500 [63.50]		0.329 [8.36]	0.494 [12.55]	2.272 [57.71]	0.422 [10.72]	0.230 [5.84]	0.426 [10.82]
SD 37 F	2.729 [69.32]	2.159 [54.84]		2.500 [63.50]	0.311 [7.90]		0.494 [12.55]	2.272 [57.71]	0.422 [10.72]	0.243 [6.17]	0.429 [10.90]
SD 50 M	2.635 [66.93]		2.079 [52.81]	2.406 [61.11]		0.441 [11.20]	0.605 [15.37]	2.178 [55.32]	0.534 [13.56]	0.230 [5.84]	0.426 [10.82]
SD 50 F	2.635 [66.93]	2.064 [52.43]		2.406 [61.11]	0.423 [10.74]		0.605 [15.37]	2.178 [55.32]	0.534 [13.56]	0.243 [6.17]	0.429 [10.90]



Note: Connectors can be kitted with all applicable crimp/solder contacts, contact Technical Sales for connector part number.

**REMOVABLE CRIMP CONTACTS**  
**CODE 1 AND 12**

CONTACTS MAY BE SUPPLIED WITH CONNECTOR OR ORDERED SEPARATELY.

**FEMALE CONTACT**

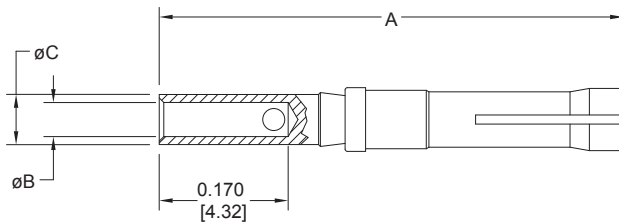

PART NUMBER	WIRE SIZE AWG/[mm <sup>2</sup> ]	A	ØB	ØC
FC7520D	20 / 22 / 24 [0.5/0.3/0.25]	0.612 [15.54]	0.045 [1.14]	0.066 [1.68]
FC7526D	26 / 28 / 30 [0.12/0.08/0.05]	0.612 [15.54]	0.026 [0.66]	0.066 [1.68]

**MALE CONTACT**

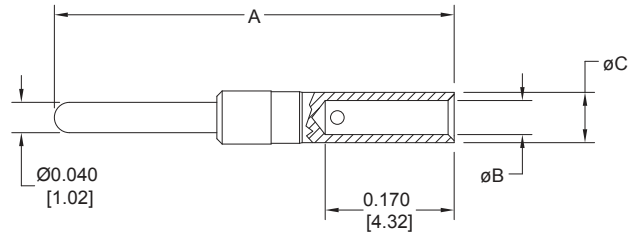

PART NUMBER	WIRE SIZE AWG/[mm <sup>2</sup> ]	A	ØB	ØC
MC7520D	20 / 22 / 24 [0.5/0.3/0.25]	0.618 [15.70]	0.045 [1.14]	0.066 [1.68]
MC7526D	26 / 28 / 30 [0.12/0.08/0.05]	0.618 [15.70]	0.026 [0.66]	0.066 [1.68]

Note: \*C75\*\*D contacts can not be used in the RD series.

**PLATING:**

**STANDARD FINISH:** Gold flash over nickel plate.

**OPTIONAL FINISHES:** 0.000030 [0.76 µ] gold over nickel by adding "-14" suffix onto part number. Example: FC7520D-14  
0.000050 inch [1.27µ] gold over nickel by adding "-15" suffix onto part number. Example: MC7526D-15

The crimp area of this contact is not protected when fully seated in the connector molding. These contacts require shrink tubing after installation. Wire cannot be removed from molding after insertion. Not suitable for fully loaded connector.

Note: Connectors can be kitted with all applicable crimp/solder contacts, contact Technical Sales for connector part number.

**REMOVABLE CRIMP CONTACTS**  
**18 AWG CRIMP CONTACTS**

18 AWG [1.0mm<sup>2</sup>]

CONTACTS MAY BE SUPPLIED WITH CONNECTOR OR ORDERED SEPARATELY.

**FEMALE CONTACT**

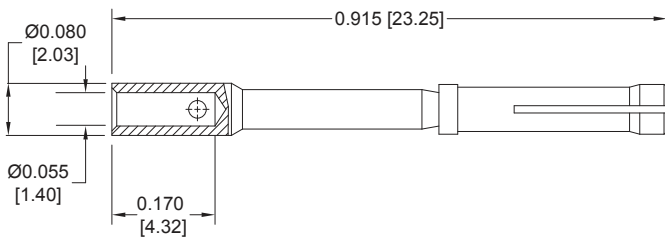

FC7518D

**MALE CONTACT**

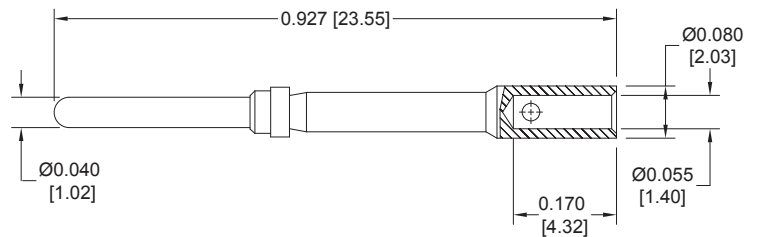

MC7518D

**PLATING:**

**STANDARD FINISH:** Gold flash over nickel plate.

**OPTIONAL FINISHES:** 0.000030 [0.76 µ] gold over nickel by adding "-14" suffix onto part number. Example: FC7518D-14  
0.000050 inch [1.27µ] gold over nickel by adding "-15" suffix onto part number. Example: MC7518D-15

For information regarding **CRIMP TOOLS & CRIMPING TOOL TECHNIQUES**, see page 78.



## STRAIGHT PRINTED BOARD MOUNT TERMINATION

CODE 3 AND 32

CODE NUMBER	L
3	0.125 [3.18]
32	0.188 [4.78]

For straight printed board mount contacts specify code number in Step 4 of ordering information.

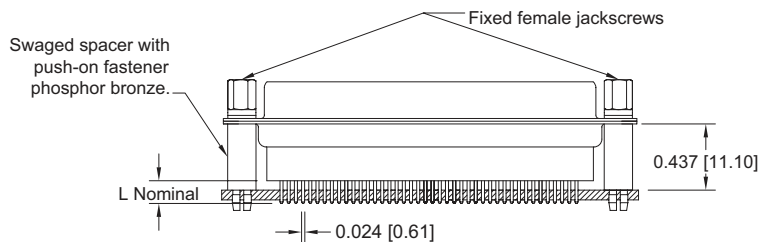

Typical Part Number:  
SD37F3S60T2X



# Connectors Designed To Customer Specifications

*Positronic D-subminiature connectors can be modified to customer specifications.*

**Examples:** select loading of contacts for cost savings or to gain creepage and clearance distances; longer printed circuit board terminations; customer specified hardware; sealing for water resistance.

*Contact Technical Sales with your particular requirements.*



### STRAIGHT PRINTED BOARD CONTACT HOLE PATTERN

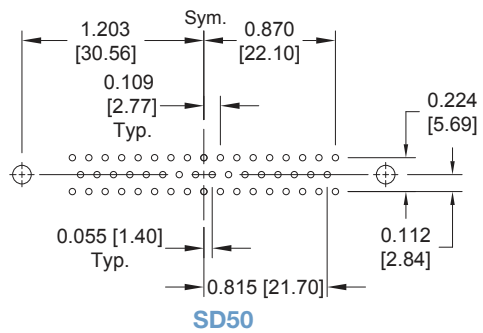
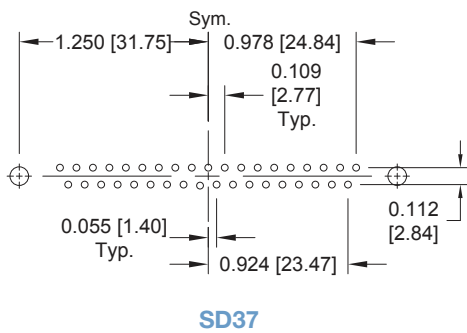
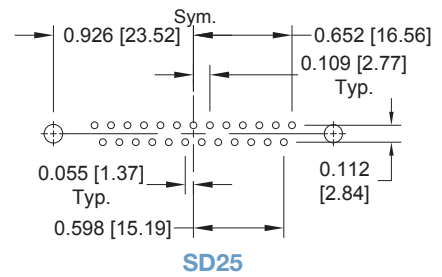
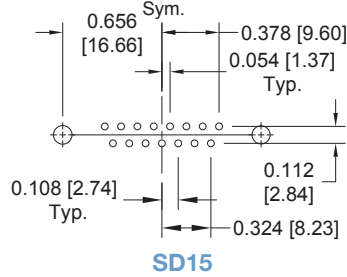
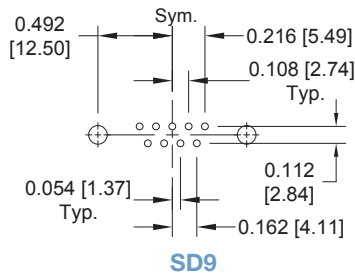

#### SUGGESTED PRINTED BOARD HOLE SIZES:

Suggest 0.045 [1.14]  $\varnothing$  hole for contact termination positions.  
Suggest 0.123  $\pm$ 0.003 [3.12  $\pm$ 0.08]  $\varnothing$  hole for mounting connector with push-on fasteners.



SD37M3S600Z



SD25F3S600X





## ORDERING INFORMATION - CODE NUMBERING SYSTEM

Specify Complete Connector By Selecting An Option From Step 1 Through 8

STEP	1	2	3	4	5	6	7	8	9	10
EXAMPLE	SD	15	F	0	0	0	0	X	/AA	-14
<b>STEP 1 - BASIC SERIES</b> SD series.										<b>STEP 10 - SPECIAL OPTIONS</b> -14 - 0.000030 [0.76µ] gold over nickel. -15 - 0.000050 [1.27µ] gold over nickel. <b>CONTACT TECHNICAL SALES FOR SPECIAL OPTIONS</b>
<b>STEP 2 - CONNECTOR VARIANTS</b> 9, 15, 25, 37, 50										
<b>STEP 3 - CONNECTOR GENDER</b> M - Male F - Female										
<b>STEP 4 - CONTACT TERMINATION TYPE</b> 0 - Contacts ordered separately, see page 23. 1 - Crimp, 20 AWG-24 AWG [0.5mm <sup>2</sup> -0.25mm <sup>2</sup> ]. 12 - Crimp, 26 AWG-30 AWG [0.12mm <sup>2</sup> -0.05mm <sup>2</sup> ]. 3 - Solder, Straight Printed Board Mount with 0.125 [3.18] Tail Length. 32 - Solder, Straight Printed Board Mount with 0.188 [4.78] Tail Length.										
<b>*1 STEP 5 - MOUNTING STYLE</b> 0 - Mounting Hole, 0.120 [3.05] Ø. 02 - Mounting Hole, 0.154 [3.91] Ø. F - Float Mounts, Universal. P - Threaded Post, Brass, 0.437 [11.10] Length. P2 - Threaded Post, Nylon, 0.437 [11.10] Length. S - Swaged Spacer, 4-40 Threads, 0.437 [11.10] Length. S2 - Swaged Spacer, 4-40 Threads, 0.125 [3.18] Length. S5 - Swaged Locknut, 4-40 Threads. S6 - Swaged Spacer with Push-on Fastener, 4-40 Threads, 0.437 [11.10] Length.										
<b>*1 STEP 6 - HOODS</b> 0 - None. J - Hood, Top Opening, Plastic. L - Hood, Side Opening, Plastic. Y - Hood, Top Opening, Plastic with Rotating Male Jackscrews. Available in size 50 only. Y6 - Hood, Top Opening, Plastic with Rotating Male and Female Polarized Jackscrews. Available in size 50 only. Z - Hood, Top or Side Opening, Robust and Extended Height, Composite and Plastic with Rotating Male Jackscrews. H - Hood, Top Opening, Metal. Available in size 15, 25, 37, and 50 only. G - Hood, EMI/RFI, Die Cast Zinc. AN - Lightweight Aluminum Hood, nickel finish. AC - Lightweight Aluminum Hood, no finish. W - Hood, Top or Side Opening, Plastic. Available in size 9,15, and 25 only.										
										<b>STEP 9 - ENVIRONMENTAL COMPLIANCE OPTIONS</b> /AA - RoHS Compliant  <b>NOTE:</b> If compliance to environmental legislation is not required, this step will not be used. Example: SD15F0000X
										<b>STEP 8 - Shell Options</b> 0 - Zinc Plated, with Chromate Seal. *3 S - Stainless steel, passivated. X - Tin Plated. Z - Tin Plated and Dimpled (male connectors only).
										<b>*1 STEP 7 - LOCKING AND POLARIZING SYSTEMS</b> 0 - None. *2 V3- Lock Tab, connector front panel mounted. *2 V5- Lock Tab, connector rear panel mounted. *2 VL - Lock Lever, used with Hoods Only. T - Fixed Female Jackscrews. T2 - Fixed Female Jackscrews. T6 - Fixed Male and Female Polarized Jackscrews. E - Rotating Male Jackscrews. E2 - Rotating Male Screw Locks. E3 - Rotating Male with internal hex for 3/32 hex drives E6 - Rotating Male and Female Polarized Jackscrews.

\*1 For additional information on accessories listed in steps 5, 6 and 7, see Accessory Catalog.  
\*2 VL, V3 and V5 locking systems are not available for connector variants 37 and 50. Jackscrews are highly recommended to minimize damage to contacts on variants with high mating forces.  
\*3 For stainless steel dimpled male versions contact Technical Sales.

**NOTE:** Once you have made a connector selection, contact Technical Sales if you would like to receive a drawing in DXF, PDF format or a 3-dimensional IGES, STEP, or SOLIDWORKS file.

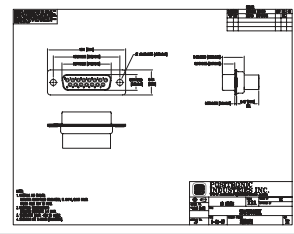

2-D Drawing

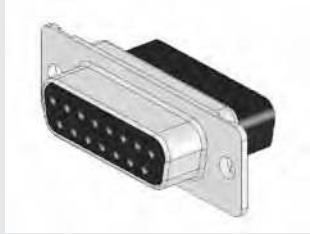

3-D Model

For information regarding **CRIMP TOOLS & CRIMPING TOOL TECHNIQUES**, see page 78.



Positronic  
connectpositronic.com

# MILITARY QUALITY FIXED CONTACT STANDARD DENSITY D-SUBMINIATURE

D-Sub

HDC SERIES

Size 20 Signal and  
Thermocouple Contacts, Fixed  
PosiBand® Closed Entry  
IEC Publication 60807-2  
Performance Level One  
MIL-DTL-24308

UL Recognized File #E49351  
CSA Recognized File #LR54219

Telecommunication  
UL File #E140980



Harmo-D series connectors are military quality connectors designed for use in sheltered, mildly corrosive environments having a wide range of temperature, pressure and humidity changes. Applicable fixed contact connectors are qualified to MIL-DTL-24308 (see page 82 for more information) and meet the performance requirements of IEC 60807-2, Performance Level One.

Harmo-D series connectors utilize precision machined contacts which are fixed within the connector body. The female contact features Positronic's unique PosiBand closed entry design, see page 1 for details.

Five standard connector variants are offered in arrangements of 9, 15, 25, 37 and 50 contacts. Each connector variant is available with contact terminations for solder cup, wrap post and straight and right angle (90°) printed board mount terminations with Inch and Metric footprints. Harmo-D series connectors are mateable and compatible with all D-subminiature connectors conforming to IEC 60807-2, IEC 60807-3 and MIL-DTL-24308.

A wide assortment of printed board mounting hardware, cable support hoods and locking systems is available from stock.

## HARMO-D SERIES TECHNICAL CHARACTERISTICS

### MATERIALS AND FINISHES:

<b>Insulator:</b>	Glass filled DAP per ASTM-D-5948, SDG-F, UL 94V-0, green color.
<b>Contacts:</b>	Precision machined copper alloy.
<b>Contact Plating:</b>	Military performance - 0.000050 inch [1.27 µ] gold over copper plate. IEC 60807-2, Performance Level One - gold flash over nickel plate. Other finishes available upon request.
<b>Shells:</b>	Steel with tin plate; zinc and cadmium plate with chromate seal, stainless steel passivated. Other materials and finishes available upon request.
<b>Mounting Spacers and Brackets:</b>	Nylon; copper alloy or steel with zinc plate and chromate seal or tin plate; phosphor bronze with tin plate; stainless steel, passivated; polyester.
<b>Push-On Fasteners:</b>	Phosphor bronze or beryllium copper with tin plate.
<b>Jackscrew Systems:</b>	Brass or steel with zinc plate and chromate seal or clear zinc plate or tin plate; stainless steel, passivated.
<b>Vibration Lock Systems:</b>	Slide lock and lock tabs, steel with nickel plate.
<b>Hoods:</b>	Composite and plastic, UL 94V-0; brass or steel with zinc plate and chromate seal. Aluminum; aluminum with electroless nickel plate. For aluminum hoods, zinc content is 1% maximum. Die cast zinc.

Low magnetic versions are available, contact Technical Sales.

### MECHANICAL CHARACTERISTICS:

<b>Fixed Contacts:</b>	Size 20 contact, male - 0.040 inch [1.02mm] mating diameter. Female contact - PosiBand closed entry design, see page 1 for details.
<b>Contact Retention In Insulator:</b>	9 lbs. [40 N].
<b>Resistance To Solder Iron Heat:</b>	650°F [350°C] for 10 seconds duration per IEC 60512-6.
<b>Contact Terminations:</b>	Solder cup contacts - 0.042 inch [1.06mm] minimum hole diameter in solder style contact for 20 AWG [0.5mm <sup>2</sup> ] wire maximum. Straight Printed Board Mount - 0.028 inch [0.71mm] termination diameter and 0.024 inch [0.61mm] termination diameter.

<b>Shells:</b>	Male shells may be dimpled for EMI/ESD ground paths.
<b>Polarization:</b>	Trapezoidally shaped shells and polarized jackscrews.
<b>Mounting To Angle Brackets:</b>	Jackscrews and riveted fasteners with 0.120 inch [3.05mm] clearance hole, and threaded riveted fasteners with 4-40 threads and polyester lock inserts.
<b>Mounting To Printed Board:</b>	Rapid installation push-on fasteners an mounting posts.
<b>Locking Systems:</b>	Jackscrews and vibration locking systems.
<b>Mechanical Operations:</b>	1000 operations minimum per IEC 60512-5.

### ELECTRICAL CHARACTERISTICS:

<b>Contact Current Rating, Tested per UL 1977:</b>	18 amperes, 2 contacts energized. 14 amperes, 6 contacts energized. 11 amperes, 15 contacts energized. 10 amperes, 25 contacts energized. 9 amperes, 50 contacts energized.
	<i>See temperature rise curves on page 2 for details.</i>
<b>Initial Contact Resistance:</b>	0.004 ohms maximum.
<b>Proof Voltage:</b>	1000 V r.m.s.
<b>Insulation Resistance:</b>	5 G ohms.
<b>Clearance and Creepage Distance [minimum]:</b>	0.039 inch [1.0mm].
<b>Working Voltage:</b>	300 V r.m.s.

### CLIMATIC CHARACTERISTICS:

<b>Temperature Range:</b>	-55°C to +125°C.
<b>Damp Heat, Steady State:</b>	56 days.

### THERMOCOUPLE CONTACTS:

Straight and right angle (90°) printed circuit board mount contacts are available, please contact Technical Sales for details.

Size 20 crimp contacts are available in RD series, see page 36 for details.

CONTACT VARIANTS

FACE VIEW OF MALE OR REAR VIEW OF FEMALE

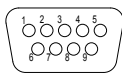

HDC 9

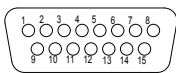

HDC 15

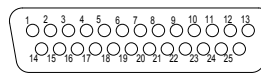

HDC 25

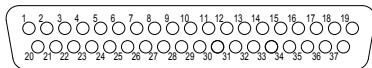

HDC 37

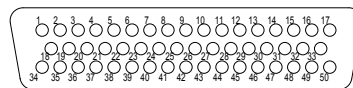

HDC 50

STANDARD SHELL ASSEMBLY

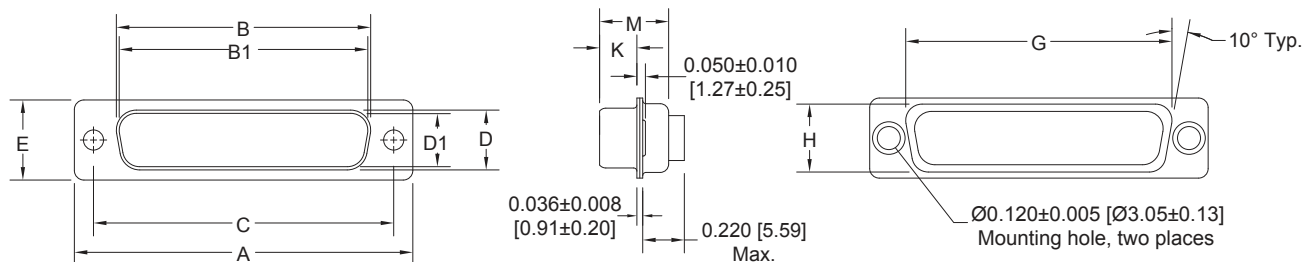

OPTIONAL SHELL ASSEMBLY (0, 02)

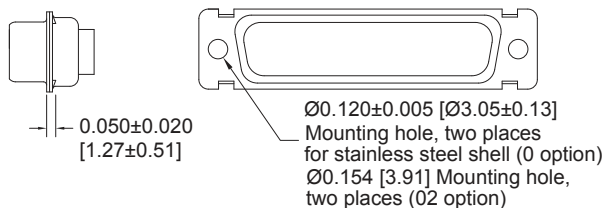

OPTIONAL SHELL ASSEMBLY WITH UNIVERSAL FLOAT MOUNTS (F)

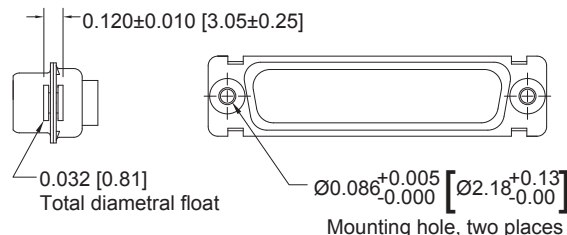

CONNECTOR VARIANT SIZES	A ±0.015 [0.38]	B ±0.005 [0.13]	B1 ±0.005 [0.13]	C ±0.005 [0.13]	D ±0.005 [0.13]	D1 ±0.005 [0.13]	E ±0.015 [0.38]	G ±0.010 [0.25]	H ±0.010 [0.25]	K ±0.005 [0.13]	M ±0.010 [0.25]
HDC 9 M	1.213 [30.81]		0.666 [16.92]	0.984 [24.99]		0.329 [8.36]	0.494 [12.55]	0.759 [19.28]	0.422 [10.72]	0.233 [5.92]	0.422 [10.72]
HDC 9 S	1.213 [30.81]	0.643 [16.33]		0.984 [24.99]	0.311 [7.90]		0.494 [12.55]	0.759 [19.28]	0.422 [10.72]	0.243 [6.17]	0.429 [10.90]
HDC 15 M	1.541 [39.14]		0.994 [25.25]	1.312 [33.32]		0.329 [8.36]	0.494 [12.55]	1.083 [27.51]	0.422 [10.72]	0.233 [5.92]	0.422 [10.72]
HDC 15 S	1.541 [39.14]	0.971 [24.66]		1.312 [33.32]	0.311 [7.90]		0.494 [12.55]	1.083 [27.51]	0.422 [10.72]	0.243 [6.17]	0.429 [10.90]
HDC 25 M	2.088 [53.04]		1.534 [38.96]	1.852 [47.04]		0.329 [8.36]	0.494 [12.55]	1.625 [41.28]	0.422 [10.72]	0.230 [5.84]	0.426 [10.82]
HDC 25 S	2.088 [53.04]	1.511 [38.38]		1.852 [47.04]	0.311 [7.90]		0.494 [12.55]	1.625 [41.28]	0.422 [10.72]	0.243 [6.17]	0.429 [10.90]
HDC 37 M	2.729 [69.32]		2.182 [55.42]	2.500 [63.50]		0.329 [8.36]	0.494 [12.55]	2.272 [57.71]	0.422 [10.72]	0.230 [5.84]	0.426 [10.82]
HDC 37 S	2.729 [69.32]	2.159 [54.84]		2.500 [63.50]	0.311 [7.90]		0.494 [12.55]	2.272 [57.71]	0.422 [10.72]	0.243 [6.17]	0.429 [10.90]
HDC 50 M	2.635 [66.93]		2.079 [52.81]	2.406 [61.11]		0.441 [11.20]	0.605 [15.37]	2.178 [55.32]	0.534 [13.56]	0.230 [5.84]	0.426 [10.82]
HDC 50 S	2.635 [66.93]	2.064 [52.43]		2.406 [61.11]	0.423 [10.74]		0.605 [15.37]	2.178 [55.32]	0.534 [13.56]	0.243 [6.17]	0.429 [10.90]



Positronic  
connectpositronic.com

MILITARY QUALITY  
FIXED CONTACT  
STANDARD DENSITY D-SUBMINIATURE

D-Sub

**SOLDER CUP TERMINATION**  
CODE 2

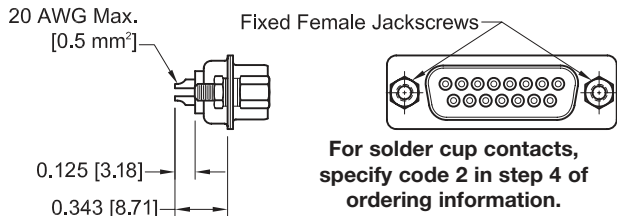

Typical Part Number: **HDC15M200T2Z**

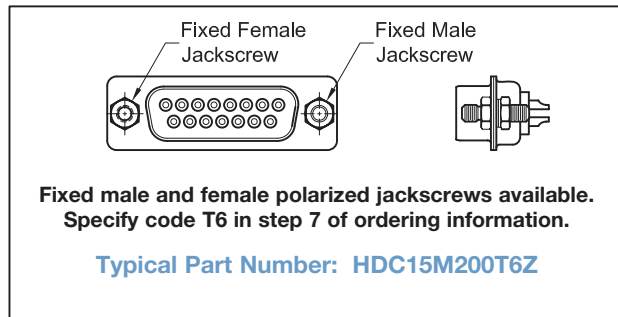

Typical Part Number: **HDC15M200T6Z**

**STRAIGHT PRINTED BOARD MOUNT TERMINATION**  
CODE 3, 32, 33, AND 36

CODE NUMBER	L	ØD
3	0.170 [4.32]	0.028 [0.71]
32	0.375 [9.53]	0.028 [0.71]
33	0.500 [12.70]	0.028 [0.71]
36	0.236 [6.00]	0.024 [0.61]

For straight printed board mount contacts, specify code no. in step 4 of ordering information.

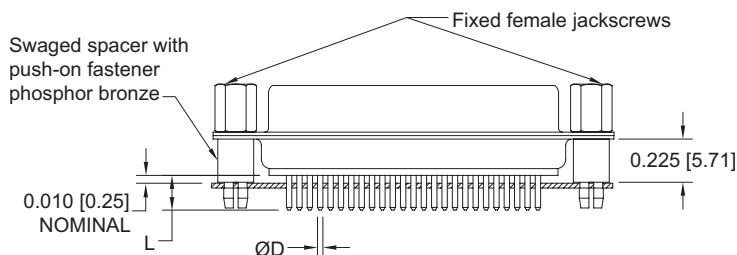

Typical Part Number: **HDC25S3S60T0**

**WRAP POST TERMINATION**  
CODE 6

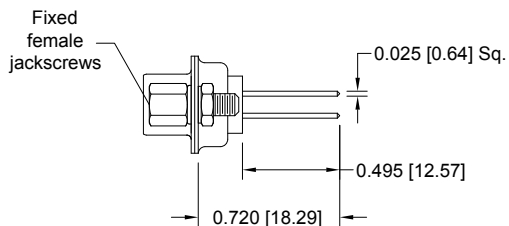

For wrap post contacts, specify code 6 in step 4 of ordering information.

Typical part number: **HDC15S600T0**



**HDC25M6S50T0**

**RIGHT ANGLE (90°) PRINTED BOARD MOUNT TERMINATION**  
CODE 5, 0.283 [7.19] CONTACT EXTENSION

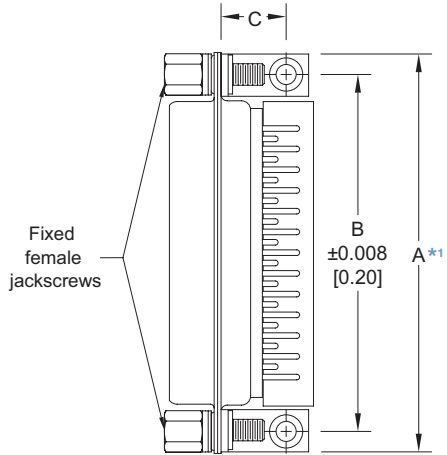

HDC**5**** 0.283 [7.19] CONTACT EXTENSION					
PART NUMBER	A*1	B	C	D	E
HDC9*5****	1.204 [30.58]	0.984 [24.99]	0.339 [8.61]	0.283 [7.19]	0.112 [2.84]
HDC15*5****	1.532 [38.91]	1.312 [33.32]	0.339 [8.61]	0.283 [7.19]	0.112 [2.84]
HDC25*5****	2.072 [52.63]	1.852 [47.04]	0.339 [8.61]	0.283 [7.19]	0.112 [2.84]
HDC37*5****	2.720 [69.09]	2.500 [63.50]	0.339 [8.61]	0.283 [7.19]	0.112 [2.84]
HDC50*5****	2.626 [66.70]	2.406 [61.11]	0.395 [10.03]	0.283 [7.19]	0.112 [2.84]

**NOTE:**

\*1 "A" dimension applies for metal angle brackets only. Consult Accessories D-subminiature catalog for "A" dimension when plastic brackets are used.

Specify code 5 in step 4 of ordering information

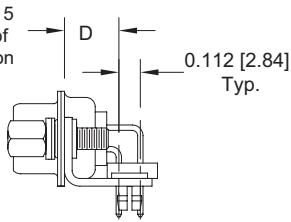

Numbering shown is rear view of male and face view of female.

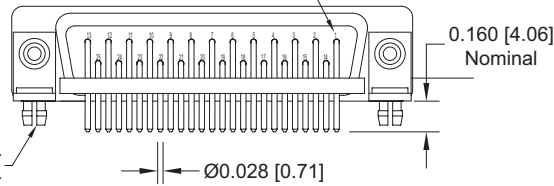

Push-on fastener beryllium copper

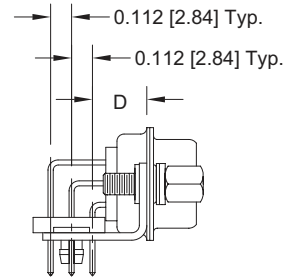

**Typical Part Number:**  
HDC25M5R7NT2X

**Typical Part Number:**  
HDC50S5R7NTX

**RIGHT ANGLE (90°) PRINTED BOARD MOUNT TERMINATION**  
CODE 42, 0.370 [9.40] CONTACT EXTENSION

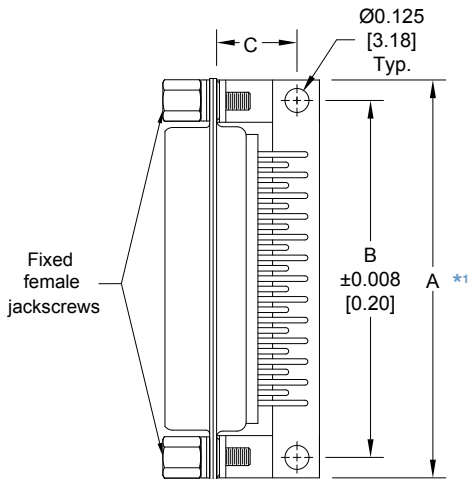

HDC**42**** 0.370 [9.40] CONTACT EXTENSION					
PART NUMBER	A*1	B	C	D	E
HDC9*42****	1.204 [30.58]	0.984 [24.99]	0.420 [10.67]	0.370 [9.40]	0.100 [2.54]
HDC15*42****	1.532 [38.91]	1.312 [33.32]	0.420 [10.67]	0.370 [9.40]	0.100 [2.54]
HDC25*42****	2.072 [52.63]	1.852 [47.04]	0.420 [10.67]	0.370 [9.40]	0.100 [2.54]
HDC37*42****	2.720 [69.09]	2.500 [63.50]	0.420 [10.67]	0.370 [9.40]	0.100 [2.54]
HDC50*42****	2.626 [66.70]	2.406 [61.11]	0.470 [11.94]	0.370 [9.40]	0.100 [2.54]

**NOTE:**

\*1 "A" dimension applies for metal angle brackets only. Consult Accessories D-subminiature catalog for "A" dimension when plastic brackets are used.

Specify code 42 in step 4 of ordering information

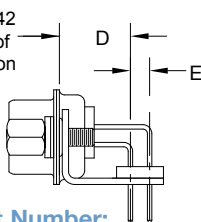

Numbering shown is rear view of male and face view of female.

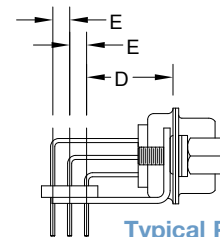
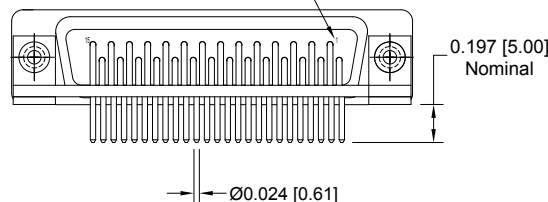

**Typical Part Number:**  
HDC25M42B30T2X

**Typical Part Number:**  
HDC50M42B30T2X



Positronic  
connectpositronic.com

# MILITARY QUALITY FIXED CONTACT STANDARD DENSITY D-SUBMINIATURE

D-Sub

## RIGHT ANGLE (90°) AND STRAIGHT PRINTED BOARD CONTACT HOLE PATTERN

MOUNT CONNECTOR WITH MATING FACE POSITIONED TO FOLLOW DIRECTION OF ARROW.

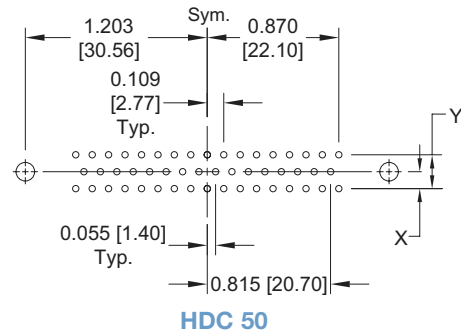
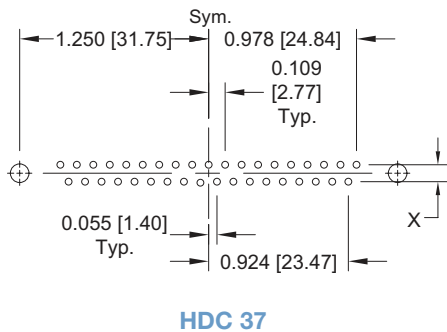
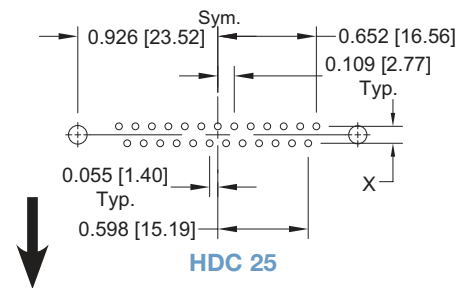
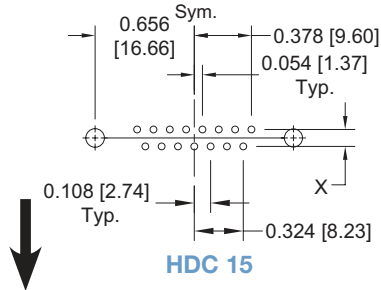
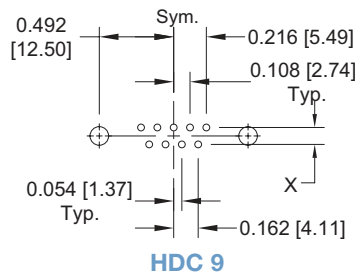

### SUGGESTED PRINTED BOARD HOLE SIZES:

- Suggest 0.039 [0.99] Ø hole for 0.024 [0.61] Ø contact termination positions.
- Suggest 0.045 [1.14] Ø hole for 0.028 [0.71] Ø contact termination positions.
- Suggest 0.123 ±0.003 [3.12 ±0.08] Ø hole for mounting connector with push-on fasteners.



CODE NUMBER	X	Y
3, 5, 32, 33, 36	0.112 [2.84]	0.224 [5.69]
*42	0.100 [2.54]	0.200 [5.08]

\*Metric system,  
European contact  
hole pattern.

**NOTE:** Once you have made a connector selection, contact Technical Sales if you would like to receive a drawing in DXF, PDF format or a 3-dimensional IGES, STEP, or SOLIDWORKS file.

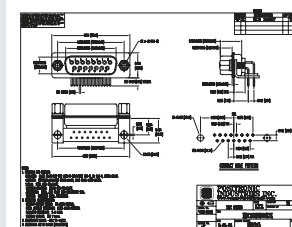

2-D Drawing



3-D Model



**ORDERING INFORMATION - CODE NUMBERING SYSTEM**

Specify Complete Connector By Selecting An Option From Step 1 Through 8

STEP	1	2	3	4	5	6	7	8	9	10	
EXAMPLE	HDC	37	S	5	B3	0	T	0	/AA	-	-50
<b>STEP 1 - BASIC SERIES</b> HDC series.										<b>STEP 10 - SPECIAL OPTIONS</b> -14 - 0.000030 [0.76µ] gold over nickel. -15 - 0.000050 [1.27µ] gold over nickel. -50 - 0.000050 [1.27µ] gold over copper. <b>CONTACT TECHNICAL SALES FOR ORDERING DETAILS OF THE FOLLOWING:</b> Other Special Requirements. Straight and Right Angle (90°) Thermocouple printed circuit board mount contacts	
<b>STEP 2 - CONNECTOR VARIANTS</b> 9, 15, 25, 37, 50											
<b>STEP 3 - CONNECTOR GENDER</b> M - Male S - Female - PosiBand closed entry contacts											
<b>STEP 4 - CONTACT TERMINATION TYPE</b> 2 - Solder cup. 3 - Solder, Straight Printed Board Mount with 0.170 [4.32] Tail Length. 32 - Solder, Straight Printed Board Mount with 0.375 [9.52] Tail Length. 33 - Solder, Straight Printed Board Mount with 0.500 [12.70] tail length. 36 - Solder, Straight Printed Board Mount with 0.236 [5.99] Tail Length. 42 - Solder, Metric System Right Angle (90°) Printed Board Mount with 0.370 [9.40] Contact Extension. 5 - Solder, Right Angle (90°) Printed Board Mount with 0.283 [7.19] Contact Extension. 6 - Wrap Post.											
<b>*1 STEP 5 - MOUNTING STYLE</b> 0 - Mounting Hole, 0.120 [3.05] Ø. 02 - Mounting Hole, 0.154 [3.91] Ø. B3 - Bracket, Mounting, Right Angle (90°) Metal with Cross Bar. B8 - Bracket, Mounting, Right Angle (90°) Plastic with Cross Bar. F - Float Mounts, Universal. P - Threaded Post, Brass, 0.225 [5.71] Length. P2 - Threaded Post, Nylon, 0.225 [5.71] Length. R2 - Bracket, Mounting, Right Angle (90°) Metal, Swaged to Connector with 4-40 Thread Fixed Female Jackscrews with Cross Bar. R6 - Bracket, Mounting, Right Angle (90°) Metal, Swaged to Connector with 0.120 [3.05] Ø Mounting Hole with Cross Bar. R7 - Bracket, Mounting, Right Angle (90°) Metal, Swaged to Connector with 4-40 Threads with Cross Bar. R8 - Bracket, Mounting, Right Angle (90°) Metal, Swaged to Connector with 4-40 Locknut with Cross Bar. S - Swaged Spacer, 4-40 Threads, 0.225 [5.71] Length. S2 - Swaged Spacer, 4-40 Threads, 0.125 [3.18] Length. S5 - Swaged Locknut, 4-40 Threads. S6 - Swaged Spacer with Push-on Fastener, 4-40 Threads, 0.225 [5.71] Length. S7 - Swaged Spacer with Push-on Fastener for use with Ferrite Inductor, 4-40 Threads, 0.375 [9.53] Length.											
<b>STEP 8 - SHELL OPTIONS</b> 0 - Zinc Plated with Chromate Seal. *3S - Stainless steel, passivated. X - Tin Plated. Z - Tin Plated and Dimpled (male connectors only). C - Cadmium plated with Chromate Seal											
<b>*1 STEP 7 - LOCKING AND POLARIZING SYSTEMS</b> 0 - None. V3 - Lock Tab, connector front panel mounted. V5 - Lock Tab, connector rear panel mounted. VL - Lock Lever, used with Hoods Only. T - Fixed Female Jackscrews. T2 - Fixed Female Jackscrews. T6 - Fixed Male and Female Polarized Jackscrews. E - Rotating Male Jackscrews. E2 - Rotating Male Screw Locks. E3 - Rotating Male with internal hex for 3/32 hex drives E6 - Rotating Male and Female Polarized Jackscrews.											
<b>*1 STEP 6 - HOODS AND PUSH-ON FASTENERS</b> 0 - None. J - Hood, Top Opening, Plastic. L - Hood, Side Opening, Plastic. Y - Hood, Top Opening, Plastic with Rotating Male Jackscrews. Available in size 50 only. Y6 - Hood, Top Opening, Plastic with Rotating Male and Female Polarized Jackscrews. Available in size 50 only. Z - Hood, Top or Side Opening, Robust and Extended Height, Composite and Plastic with Rotating Male Jackscrews. H - Hood, Top Opening, Metal. Available in size 15, 25, 37 and 50 only. G - Hood, EMI/RFI, Die Cast Zinc. AN - Lightweight Aluminum Hood, nickel finish. AC - Lightweight Aluminum Hood, no finish. W - Hood, Top or Side Opening, Plastic. Available in size 9, 15, and 25 only. N - Push-on Fastener, for Right Angle (90°) Mounting Brackets. *2F - Ferrite Inductor.											
<b>STEP 9 - ENVIRONMENTAL COMPLIANCE OPTIONS</b> /AA - RoHS Compliant <b>NOTE:</b> If compliance to environmental legislation is not required, this step will not be used. Example: HDC37S5B30T0											



Positronic  
connectpositronic.com

# MILITARY QUALITY CRIMP REMOVABLE CONTACT STANDARD DENSITY D-SUBMINIATURE

D-Sub

RD SERIES

Size 20 Signal and  
Thermocouple Contacts,  
Crimp Removable  
PosiBand® Closed Entry  
IEC Publication 60807-3  
Performance Level One,  
MIL-DTL-24308 & SAE AS39029

UL Recognized  
File #E49351

CSA Recognized  
File #LR54219

Telecommunication  
UL File #E140980



Rhapsody-D series connectors are military quality connectors designed for use in sheltered, mildly corrosive environments having a wide range of temperature, pressure and humidity changes. Applicable crimp removable contact connectors are qualified to MIL-DTL-24308 and SAE AS39029 (see page 82 for more information), and will meet the performance requirements of IEC 60807-3, Performance Level One.

Rhapsody-D series connectors utilize precision machined contacts with closed barrel, crimp terminations. The

female utilizes Positronic's unique PosiBand closed entry system, see page 1 for details. Rugged open entry female contacts are also available.

Six standard connector variants are offered in arrangements of 9, 15, 25, 29, 37 and 50 contacts. Rhapsody-D series connectors are mateable and compatible with all D-subminiature connectors conforming to MIL-DTL-24308, IEC 60807-2 and IEC 60807-3.

A wide assortment of cable support hoods and locking systems is available from stock.

## RHAPSO-D SERIES TECHNICAL CHARACTERISTICS

### MATERIALS AND FINISHES:

<b>Insulator:</b>	Glass filled DAP per ASTM-D-5948, SDG-F, UL 94V-0, green color.
<b>Contacts:</b>	Precision machined copper alloy.
<b>Contact Plating:</b>	Military performance - 0.000050 inch [1.27 µ] gold over nickel plate. IEC 60807-3, Performance Level One - gold flash over nickel plate. Other finishes available upon request.
<b>Shells:</b>	Steel with tin plate; zinc and cadmium plate with chromate seal, stainless steel passivated. Other materials and finishes available upon request.
<b>Mounting Spacers:</b>	Nylon; copper alloy or steel with zinc plate and chromate seal or tin plate; phosphor bronze with tin plate; stainless steel, passivated.
<b>Jackscrew Systems:</b>	Brass or steel with zinc plate and chromate seal or clear zinc plate or tin plate; stainless steel, passivated.
<b>Vibration Lock Systems:</b>	Slide lock and lock tabs, steel with nickel plate.
<b>Hoods:</b>	Composite and plastic, UL 94V-0; brass or steel with zinc plate and chromate seal. Aluminum; aluminum with electroless nickel plate. For aluminum hoods, zinc content is 1% maximum. Die cast zinc.

Low magnetic versions are available, contact Technical Sales.

### MECHANICAL CHARACTERISTICS:

<b>Removable Contacts:</b>	Insert contact to rear face of insulator and release from rear face of insulator. Size 20 contact, male - 0.040 inch [1.02mm] mating diameter. Female - PosiBand closed entry design, see page 1 for details.
----------------------------	---

### Contact Retention

<b>In Insulator:</b>	9 lbs. [40 N].
<b>Contact Terminations:</b>	Closed barrel crimp, wire sizes 18 AWG [1.0mm <sup>2</sup> ] through 30 AWG [0.05mm <sup>2</sup> ].
<b>Shells:</b>	Male shells may be dimpled for EMI/ESD ground paths.
<b>Polarization:</b>	Trapezoidally shaped shells and polarized jackscrews.
<b>Locking Systems:</b>	Jackscrews and vibration locking systems.
<b>Mechanical Operations:</b>	1000 operations minimum per IEC 60512-5 for PosiBand closed entry female contact.

### ELECTRICAL CHARACTERISTICS:

#### Contact Current Rating, Tested per UL 1977:

18 amperes, 2 contacts energized.
14 amperes, 6 contacts energized.
11 amperes, 15 contacts energized.
10 amperes, 25 contacts energized.
9 amperes, 50 contacts energized.

See temperature rise curves on page 2 for details.

<b>Initial Contact Resistance:</b>	0.004 ohms maximum.
<b>Proof Voltage:</b>	1000 V r.m.s.
<b>Insulation Resistance:</b>	5 G ohms.
<b>Clearance and Creepage Distance [minimum]:</b>	0.039 inch [1.0mm].
<b>Working Voltage:</b>	300 V r.m.s.

### CLIMATIC CHARACTERISTICS:

<b>Temperature Range:</b>	-55°C to +125°C.
<b>Damp Heat, Steady State:</b>	21 days.

### THERMOCOUPLE CONTACTS:

Size 20 crimp contacts are available, see page 36 for details.

Printed circuit board mount contacts are available in HDC series, see page 27 for details.





CONTACT VARIANTS

FACE VIEW OF MALE OR REAR VIEW OF FEMALE

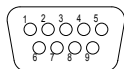

RD 9

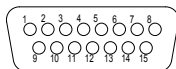

RD 15

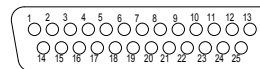

RD 25

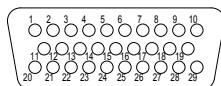

RD 29

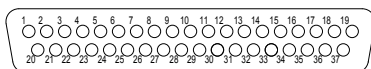

RD 37

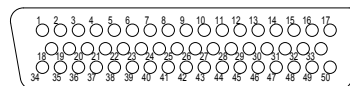

RD 50

STANDARD SHELL ASSEMBLY

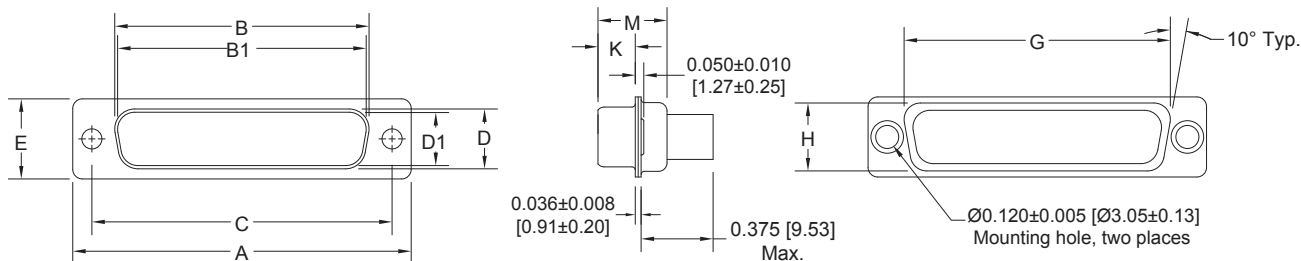

OPTIONAL SHELL ASSEMBLY (0, 02)

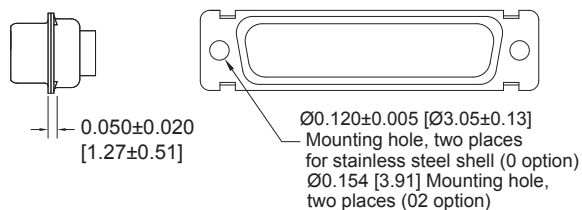

OPTIONAL SHELL ASSEMBLY WITH UNIVERSAL FLOAT MOUNTS (F)

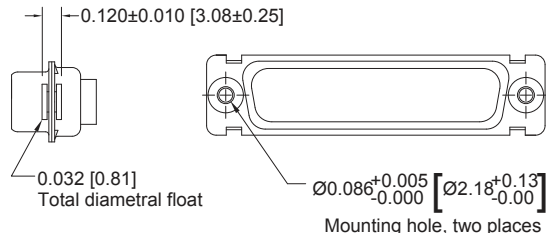

CONNECTOR VARIANT SIZES	A ±0.015 [0.38]	B ±0.005 [0.13]	B1 ±0.005 [0.13]	C ±0.005 [0.13]	D ±0.005 [0.13]	D1 ±0.005 [0.13]	E ±0.015 [0.38]	G ±0.010 [0.25]	H ±0.010 [0.25]	K ±0.005 [0.13]	M ±0.010 [0.25]
RD 9 M	1.213 [30.81]		0.666 [16.92]	0.984 [24.99]		0.329 [8.36]	0.494 [12.55]	0.759 [19.28]	0.422 [10.72]	0.233 [5.92]	0.422 [10.72]
RD 9 S	1.213 [30.81]	0.643 [16.33]		0.984 [24.99]	0.311 [7.90]		0.494 [12.55]	0.759 [19.28]	0.422 [10.72]	0.243 [6.17]	0.429 [10.90]
RD 15 M	1.541 [39.14]		0.994 [25.25]	1.312 [33.32]		0.329 [8.36]	0.494 [12.55]	1.083 [27.51]	0.422 [10.72]	0.233 [5.92]	0.422 [10.72]
RD 15 S	1.541 [39.14]	0.971 [24.66]		1.312 [33.32]	0.311 [7.90]		0.494 [12.55]	1.083 [27.51]	0.422 [10.72]	0.243 [6.17]	0.429 [10.90]
RD 25 M	2.088 [53.04]		1.534 [38.96]	1.852 [47.04]		0.329 [8.36]	0.494 [12.55]	1.625 [41.28]	0.422 [10.72]	0.230 [5.84]	0.426 [10.82]
RD 25 S	2.088 [53.04]	1.511 [38.38]		1.852 [47.04]	0.311 [7.90]		0.494 [12.55]	1.625 [41.28]	0.422 [10.72]	0.243 [6.17]	0.429 [10.90]
RD 29 M	1.770 [44.96]		1.274 [32.36]	1.534 [38.96]		0.450 [11.43]	0.605 [15.37]	1.322 [33.58]	0.539 [13.69]	0.230 [5.84]	0.426 [10.82]
RD 29 S	1.770 [44.96]	1.251 [31.78]		1.534 [38.96]	0.431 [10.95]		0.605 [15.37]	1.322 [33.58]	0.539 [13.69]	0.237 [6.02]	0.429 [10.90]
RD 37 M	2.729 [69.32]		2.182 [55.42]	2.500 [63.50]		0.329 [8.36]	0.494 [12.55]	2.272 [57.71]	0.422 [10.72]	0.230 [5.84]	0.426 [10.82]
RD 37 S	2.729 [69.32]	2.159 [54.84]		2.500 [63.50]	0.311 [7.90]		0.494 [12.55]	2.272 [57.71]	0.422 [10.72]	0.243 [6.17]	0.429 [10.90]
RD 50 M	2.635 [66.93]		2.079 [52.81]	2.406 [61.11]		0.441 [11.20]	0.605 [15.37]	2.178 [55.32]	0.534 [13.56]	0.230 [5.84]	0.426 [10.82]
RD 50 S	2.635 [66.93]	2.064 [52.43]		2.406 [61.11]	0.423 [10.74]		0.605 [15.37]	2.178 [55.32]	0.534 [13.56]	0.243 [6.17]	0.429 [10.90]



Positronic  
connectpositronic.com

# MILITARY QUALITY CRIMP REMOVABLE CONTACT STANDARD DENSITY D-SUBMINIATURE

D-Sub

## REMOVABLE CRIMP CONTACTS CODE 1 AND 12

CONTACTS MAY BE SUPPLIED WITH CONNECTOR OR ORDERED SEPARATELY.  
QUALIFIED TO SAE AS39029

### \*MILITARY SPECIFICATION CONTACTS

**STANDARD FINISH:**  
per SAE AS39029 specifications

**COLOR CODE:**  
**MALE CONTACT:**  
ORANGE/BLUE/WHITE  
**FEMALE CONTACT:**  
ORANGE/BLUE/GRAY

Note: Connectors can be kitted with all applicable crimp/solder contacts, contact Technical Sales for connector part number.

### FEMALE CONTACT "CLOSED ENTRY" DESIGN

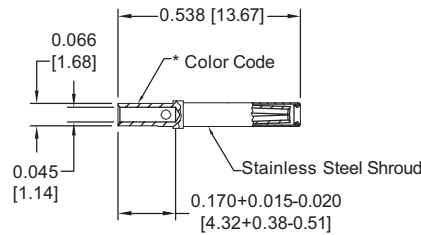

### MALE CONTACT

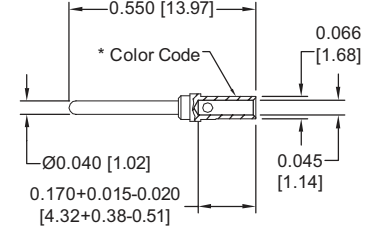

FEMALE PART NUMBER	WIRE SIZE AWG/[mm <sup>2</sup> ]
*M39029/63-368	20 / 22 / 24 [0.5/0.3/0.25]
Positronic is qualified to supply the legacy design, as well as, the PosiBand design. If the requirement is for the PosiBand design exclusively, notify sales at time of quotation for order placement when requesting M39029 contacts.	

MALE PART NUMBER	WIRE SIZE AWG/[mm <sup>2</sup> ]
*M39029/64-369	20 / 22 / 24 [0.5/0.3/0.25]

## REMOVABLE CRIMP CONTACTS CODE 1 AND 12

CONTACTS MAY BE SUPPLIED WITH CONNECTOR OR ORDERED SEPARATELY.



Authentic POSITRONIC  
PosiBand®

These contacts utilize authentic Positronic PosiBand® technology.  
Protected by U.S. Patent 7,115,002

Note: Connectors can be kitted with all applicable crimp/solder contacts, contact Technical Sales for connector part number.

### PLATING:

**STANDARD FINISH:**  
Gold flash over nickel plate.

**OPTIONAL FINISHES:**  
0.000030 [0.76] gold over nickel by adding "-14" suffix onto part number. Example: FC6020D2-14  
0.000050 inch [1.27] gold over nickel by adding "-15" suffix onto part number. Example: MC6026D-15

### FEMALE CONTACT

"CLOSED ENTRY" DESIGN

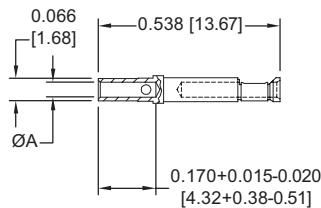

### MALE CONTACT

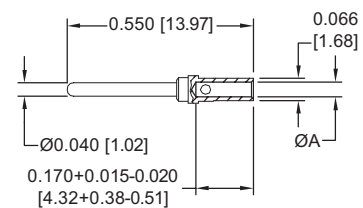

FEMALE PART NUMBER	WIRE SIZE AWG/[mm <sup>2</sup> ]	ØA
FC6020D2	20 / 22 / 24 [0.5/0.3/0.25]	0.045 [1.14]
FC6026D2	26 / 28 / 30 [0.12/0.08/0.05]	0.027 [0.69]

MALE PART NUMBER	WIRE SIZE AWG/[mm <sup>2</sup> ]	ØA
MC6020D	20 / 22 / 24 [0.5/0.3/0.25]	0.045 [1.14]
MC6026D	26 / 28 / 30 [0.12/0.08/0.05]	0.027 [0.69]

Note: FC602\*D2 and MC602\*D contacts can be used in the SD series.

For information regarding **CRIMP TOOLS & CRIMPING TOOL TECHNIQUES**, see page 78.



Authentic POSITRONIC®  
**PosiBand®**

These contacts utilize authentic Positronic PosiBand® technology.  
Protected by U.S. Patent 7,115,002.

**REMOVABLE CRIMP CONTACTS**  
**18 AWG CRIMP CONTACTS**  
18 AWG [1.0mm<sup>2</sup>]

The crimp area of this contact is not protected when fully seated in the connector tubing molding. These contacts require shrink tubing after installation. Wire cannot be removed from molding after insertion. Not suitable for fully loaded connector.

CONTACTS MAY BE SUPPLIED WITH CONNECTOR OR ORDERED SEPARATELY.

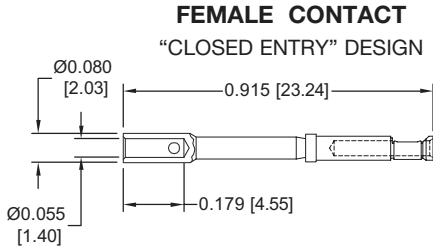

Note: Connectors can be kitted with all applicable crimp/solder contacts, contact Technical Sales for connector part number.

Note: FC6018D2 and MC6018D contacts can be used in the ORD series.

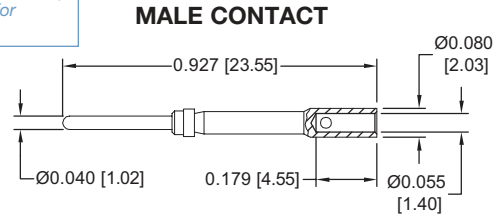

FEMALE PART NUMBER	WIRE SIZE AWG/[mm <sup>2</sup> ]
FC6018D2	18 [1.0] max

MALE PART NUMBER	WIRE SIZE AWG/[mm <sup>2</sup> ]
MC6018D	18 [1.0] max

**PLATING:**

**STANDARD FINISH:** Gold flash over nickel plate.

**OPTIONAL FINISHES:**

0.000030 [0.76] gold over nickel by adding "-14" suffix onto part number. Example: FC6018D2-14  
0.000050 inch [1.27] gold over nickel by adding "-15" suffix onto part number. Example: MC6018D-15

**REMOVABLE THERMOCOUPLE CRIMP CONTACT**

CONTACTS MAY BE SUPPLIED WITH CONNECTOR OR ORDERED SEPARATELY.

Note: Connectors can be kitted with all applicable crimp/solder contacts, contact Technical Sales for connector part number..



Authentic POSITRONIC®  
**PosiBand®**

These contacts utilize authentic Positronic PosiBand® technology.  
Protected by U.S. Patent 7,115,002.

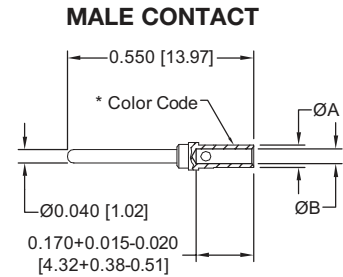
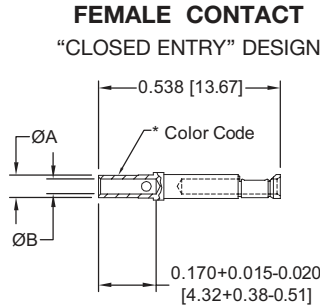

TYPE	MATERIAL	FEMALE PART NUMBER	MALE PART NUMBER	COLOR CODE	WIRE SIZE AWG [mm <sup>2</sup> ]	ØA	ØB
K	CHROMEL (+)	FC6020D2CH <sup>††</sup>	MC6020DCH <sup>†</sup>	WHITE	20 / 22 / 24 [0.5 / 0.3 / 0.25]	0.066 [1.68]	0.045 [1.14]
		FC6026D2CH	MC6026DCH		26 / 28 / 30 [0.12 / 0.08 / 0.05]	0.048 [1.23]	0.027 [0.69]
	ALUMEL (-)	FC6020D2AL <sup>††</sup>	MC6020DAL <sup>†</sup>	GREEN	20 / 22 / 24 [0.5 / 0.3 / 0.25]	0.066 [1.68]	0.045 [1.14]
		FC6026D2AL	MC6026DAL		26 / 28 / 30 [0.12 / 0.08 / 0.05]	0.048 [1.23]	0.027 [0.69]
T	COPPER (+) with gold flash	FC6020D2CU <sup>††</sup>	MC6020DCU <sup>†</sup>	RED	20 / 22 / 24 [0.5 / 0.3 / 0.25]	0.066 [1.68]	0.045 [1.14]
		FC6026D2CU	MC6026DCU		26 / 28 / 30 [0.12 / 0.08 / 0.05]	0.048 [1.23]	0.027 [0.69]
	CONSTANTAN (-)	FC6020D2CO <sup>††</sup>	MC6020DCO <sup>†</sup>	YELLOW	20 / 22 / 24 [0.5 / 0.3 / 0.25]	0.066 [1.68]	0.045 [1.14]
		FC6026D2CO	MC6026DCO		26 / 28 / 30 [0.12 / 0.08 / 0.05]	0.048 [1.23]	0.027 [0.69]
E	CHROMEL (+)	FC6020D2CH <sup>††</sup>	MC6020DCH <sup>†</sup>	WHITE	20 / 22 / 24 [0.5 / 0.3 / 0.25]	0.066 [1.68]	0.045 [1.14]
		FC6026D2CH	MC6026DCH		26 / 28 / 30 [0.12 / 0.08 / 0.05]	0.048 [1.23]	0.027 [0.69]
	CONSTANTAN (-)	FC6020D2CO <sup>††</sup>	MC6020DCO <sup>†</sup>	YELLOW	20 / 22 / 24 [0.5 / 0.3 / 0.25]	0.066 [1.68]	0.045 [1.14]
		FC6026D2CO	MC6026DCO		26 / 28 / 30 [0.12 / 0.08 / 0.05]	0.048 [1.23]	0.027 [0.69]

For more information on the availability of Type J thermocouple contacts, and information about thermocouple contacts with printed circuit board solder termination, please contact Technical Sales.

Chromel® and Alumel® are registered trademarks of Hoskins Manufacturing Company.

<sup>†</sup>Dimensionally equivalent to M39029/64-369

<sup>††</sup>Dimensionally equivalent to M39029/63-368

For information regarding **CRIMP TOOLS & CRIMPING TOOL TECHNIQUES**, see page 78.



Positronic  
connectpositronic.com

# MILITARY QUALITY CRIMP REMOVABLE CONTACT STANDARD DENSITY D-SUBMINIATURE

D-Sub

## ORDERING INFORMATION - CODE NUMBERING SYSTEM

Specify Complete Connector By Selecting An Option From Step 1 Through 8

STEP	1	2	3	4	5	6	7	8	9	10
EXAMPLE	RD	25	S	1	0	J	VL	0	/AA	-50

### STEP 1 - BASIC SERIES

RD series.

### STEP 2 - CONNECTOR VARIANTS

9, 15, 25, 29, 37, 50

### STEP 3 - CONNECTOR GENDER

M - Male  
S - Female - PosiBand closed entry contacts

### STEP 4 - CONTACT TERMINATION TYPE

0 - Contacts ordered separately, see pages 35-36.  
1 - Crimp, 20 AWG-24 AWG [0.5mm<sup>2</sup>-0.25mm<sup>2</sup>].  
12 - Crimp, 26 AWG-30 AWG [0.12mm<sup>2</sup>-0.05mm<sup>2</sup>].

### \*1 STEP 5 - MOUNTING STYLE

0 - Mounting Hole, 0.120 [3.05] Ø.  
02 - Mounting Hole, 0.154 [3.91] Ø.  
F - Float Mounts, Universal.  
S2 - Swaged Spacer, 4-40 Threads, 0.125 [3.18] Length.  
S5 - Swaged Locknut, 4-40 Threads.

### \*1 STEP 6 - HOODS

0 - None.  
J - Hood, Top Opening, Plastic.  
L - Hood, Side Opening, Plastic.  
Y - Hood, Top Opening, Plastic with Rotating Male Jackscrews. Available in size 50 only.  
Y6 - Hood, Top Opening, Plastic with Rotating Male and Female Polarized Jackscrews. Available in size 50 only.  
Z - Hood, Top or Side Opening, Robust Extended Height, Composite and Plastic with Rotating Male Jackscrews. Available in size 9, 15, 25, 37, and 50 only.  
H - Hood, Top Opening, Metal. Available in size 15, 25, 37, and 50 only.  
G - Hood, EMI/RFI, Die Cast Zinc. Available in size 9, 15, 25, 37, and size 50 only.  
\*3 AN - Lightweight Aluminum Hood, nickel finish.  
\*3 AC - Lightweight Aluminum Hood, no finish.  
W - Hood, Top or Side Opening, Plastic. Available in size 9, 15, and 25 only.

\*1 For additional information on accessories listed in steps 5, 6 and 7, see Accessory Catalog.

\*2 For stainless steel dimpled male versions contact Technical Sales.

\*3 AN and AC hood are not available for connector variant 29. Consult Technical Sales for availability.

For information regarding **CRIMP TOOLS & CRIMPING TOOL TECHNIQUES**, see page 78.

### STEP 10 - SPECIAL OPTIONS

-14 - 0.000030 [0.76µ] gold over nickel.  
-15 - 0.000050 [1.27µ] gold over nickel.  
-50 - 0.000050 [1.27µ] gold over copper.

**CONTACT TECHNICAL SALES FOR SPECIAL OPTIONS**

### STEP 9 - ENVIRONMENTAL COMPLIANCE OPTIONS

/AA - RoHS Compliant

**NOTE:** If compliance to environmental legislation is not required, this step will not be used. Example: RD25S10JVLO

### STEP 8 - SHELL OPTIONS

0 - Zinc Plated with Chromate Seal.  
\*2S - Stainless steel, passivated.  
X - Tin Plated.  
Z - Tin Plated and Dimpled (male connectors only).  
C - Cadmium plated with Chromate Seal.

### \*1 STEP 7 - LOCKING AND POLARIZING SYSTEMS

0 - None.  
V3 - Lock Tab, connector front panel mounted.  
V5 - Lock Tab, connector rear panel mounted.  
VL - Lock Lever, used with Hoods Only.  
T - Fixed Female Jackscrews.  
T2 - Fixed Female Jackscrews.  
T6 - Fixed Male and Female Polarized Jackscrews.  
E - Rotating Male Jackscrews.  
E2 - Rotating Male Screw Locks.  
E3 - Rotating Male with internal hex for 3/32 hex drives  
E6 - Rotating Male and Female Polarized Jackscrews.

**NOTE:** Once you have made a connector selection, contact Technical Sales if you would like to receive a drawing in DXF, PDF format or a 3-dimensional IGES, STEP, or SOLIDWORKS file.

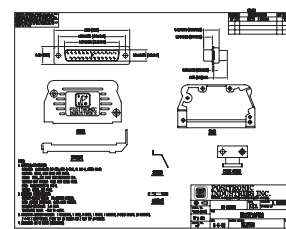

2-D Drawing



3-D Model



Size 20 Signal and  
Thermocouple Contacts,  
Crimp Removable

Two Performance  
Levels For Best Cost /  
Performance Ratio

IEC Publication 60807-3  
Performance Level Two - Professional  
Performance Level One - Industrial



ORD series connectors are professional / industrial quality connectors with closed barrel crimp removable contacts. ORD series connectors are recommended for use in sheltered, mildly corrosive environments having a wide range of temperatures with normal ventilation where high performance is required.

ORD series connectors utilize precision-machined contacts to provide durability. Female contacts feature the low cost, high performance rugged open entry design, meeting the performance requirements of

IEC 60807-3, Performance Level Two. Female PosiBand closed entry contacts are optional and meet IEC 807-3, Performance Level One.

Six standard contact variants are offered in arrangements of 9, 15, 25, 29, 37, and 50 contacts. ORD series connectors are mateable and compatible with all D-Subminiature connectors conforming to MIL-DTL-24308, IEC 60807-2, and IEC 60807-3.

A wide assortment of cable support hoods and locking systems is available from stock.

## ORD SERIES TECHNICAL CHARACTERISTICS

### MATERIALS AND FINISHES:

<b>Insulators:</b>	Glass filled DAP per ASTM-D-5948, SDG-F, UL 94V-0, green color.
<b>Contacts:</b>	Precision machined copper alloy.
<b>Contact Plating:</b>	Industrial performance - gold flash over nickel plate. Other finishes available upon request.
<b>Shells:</b>	Steel with tin plate; zinc plate with chromate seal, stainless steel passivated. Other materials and finishes available upon request.
<b>Mounting Spacers:</b>	Nylon; copper alloy or steel with zinc plate and chromate seal or tin plate; phosphor bronze with tin plate; stainless steel, passivated.
<b>Vibration Lock Systems:</b>	Slide lock and lock tabs, steel with nickel plate.
<b>Jackscrew Systems:</b>	Brass or steel with zinc plate and chromate seal or clear zinc plate or tin plate; stainless steel, passivated.
<b>Hoods:</b>	Composite and plastic, UL 94V-0; brass or steel with zinc plate and chromate seal. Aluminum; aluminum with electroless nickel plate. For aluminum hoods, zinc content is 1% maximum. Die cast zinc.

Low magnetic versions are available, contact Technical Sales.

### MECHANICAL CHARACTERISTICS:

<b>Removable Contacts:</b>	Insert contact to rear face of insulator and release from rear face of insulator. Size 20 contact, male - 0.040 inch [1.02mm] mating diameter. Female contacts - rugged open entry design or PosiBand closed entry design, see page 1 for details.
<b>Contact Retention In Insulator:</b>	9 lbs. [40 N].
<b>Contact Terminations:</b>	Closed barrel crimp, wire sizes 18 AWG [1.0mm <sup>2</sup> ] through 24 AWG [0.25mm <sup>2</sup> ].
<b>Shells:</b>	Tin-plated male shells may be dimpled for EMI/ESD ground paths.

<b>Polarization:</b>	Trapezoidally shaped shells and polarized jackscrews.
<b>Locking Systems:</b>	Jackscrews and vibration locking systems.
<b>Mechanical Operations:</b>	500 operations minimum per IEC 60512-5 for rugged open entry design. 1000 operations minimum per IEC 60512-5 for PosiBand closed entry female contact.

### ELECTRICAL CHARACTERISTICS:

<b>Contact Current Rating:</b>	
<b>Open Entry Contacts:</b>	7.5 amperes nominal
<b>Closed Entry Contacts, tested per UL 1977:</b>	18 amperes, 2 contacts energized. 14 amperes, 6 contacts energized. 11 amperes, 15 contacts energized. 10 amperes, 25 contacts energized. 9 amperes, 50 contacts energized.
<i>See temperature rise curves on page 2 for details.</i>	
<b>Initial Contact Resistance:</b>	0.008 ohms maximum for open entry 0.004 ohms maximum for closed entry
<b>Proof Voltage:</b>	1000 V r.m.s.
<b>Insulation Resistance:</b>	5 G ohms.
<b>Clearance and Creepage Distance [minimum]:</b>	0.039 inch [1.0mm].
<b>Working Voltage:</b>	300 V r.m.s.

### CLIMACTIC CHARACTERISTICS:

<b>Temperature Range:</b>	-55°C to +125°C.
<b>Damp Heat, Steady State:</b>	10 days.

### THERMOCOUPLE CONTACTS:

Size 20 crimp contacts are available. See page 41 for details.

Printed circuit board mount contacts are available in HDC series, see page 27 for details.

DIMENSIONS ARE IN INCHES [MILLIMETERS].  
ALL DIMENSIONS ARE SUBJECT TO CHANGE.



Positronic  
connectpositronic.com

PROFESSIONAL / INDUSTRIAL QUALITY  
REMOVABLE CONTACT  
STANDARD DENSITY D-SUBMINIATURE

D-Sub

CONTACT VARIANTS  
FACE VIEW OF MALE OR REAR VIEW OF FEMALE

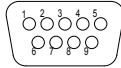

ORD 9

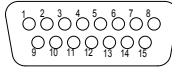

ORD 15

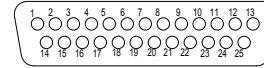

ORD 25

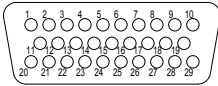

ORD 29

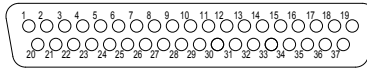

ORD 37

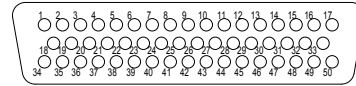

ORD 50

STANDARD SHELL ASSEMBLY

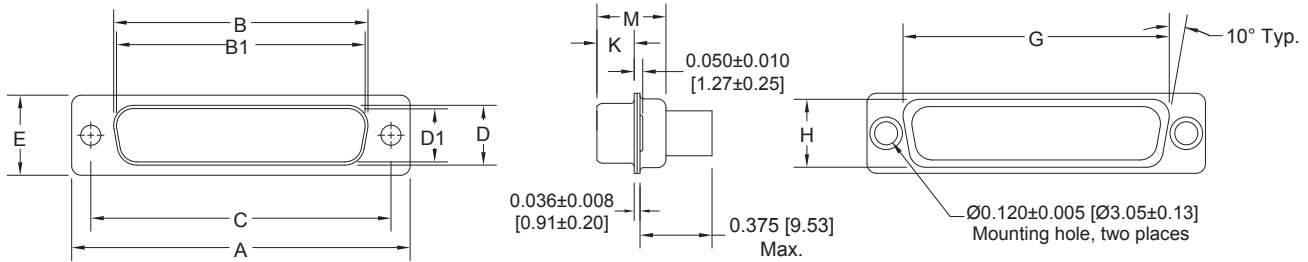

OPTIONAL SHELL ASSEMBLY (0, 02)

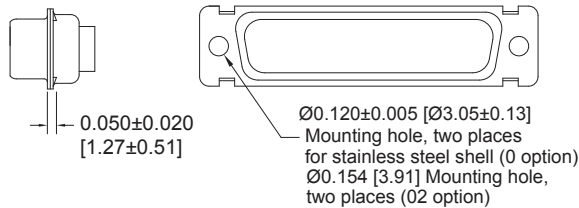

OPTIONAL SHELL ASSEMBLY WITH UNIVERSAL FLOAT MOUNTS (F)

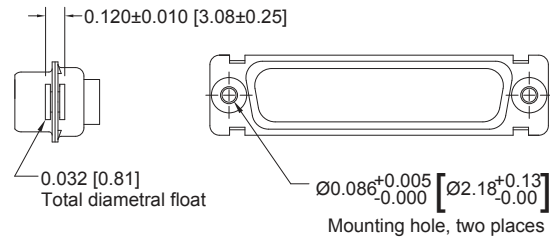

CONNECTOR VARIANT SIZES	A ±0.015 [0.38]	B ±0.005 [0.13]	B1 ±0.005 [0.13]	C ±0.005 [0.13]	D ±0.005 [0.13]	D1 ±0.005 [0.13]	E ±0.015 [0.38]	G ±0.010 [0.25]	H ±0.010 [0.25]	K ±0.005 [0.13]	M ±0.010 [0.25]
ORD 9 M	1.213 [30.81]		0.666 [16.92]	0.984 [24.99]		0.329 [8.36]	0.494 [12.55]	0.759 [19.28]	0.422 [10.72]	0.233 [5.92]	0.422 [10.72]
ORD 9 F ORD 9 S	1.213 [30.81]	0.643 [16.33]		0.984 [24.99]	0.311 [7.90]		0.494 [12.55]	0.759 [19.28]	0.422 [10.72]	0.243 [6.17]	0.429 [10.90]
ORD 15 M	1.541 [39.14]		0.994 [25.25]	1.312 [33.32]		0.329 [8.36]	0.494 [12.55]	1.083 [27.51]	0.422 [10.72]	0.233 [5.92]	0.422 [10.72]
ORD 15 F ORD 15 S	1.541 [39.14]	0.971 [24.66]		1.312 [33.32]	0.311 [7.90]		0.494 [12.55]	1.083 [27.51]	0.422 [10.72]	0.243 [6.17]	0.429 [10.90]
ORD 25 M	2.088 [53.04]		1.534 [38.96]	1.852 [47.04]		0.329 [8.36]	0.494 [12.55]	1.625 [41.28]	0.422 [10.72]	0.230 [5.84]	0.426 [10.82]
ORD 25 F ORD 25 S	2.088 [53.04]	1.511 [38.38]		1.852 [47.04]	0.311 [7.90]		0.494 [12.55]	1.625 [41.28]	0.422 [10.72]	0.243 [6.17]	0.429 [10.90]
ORD 29 M	1.770 [44.96]		1.274 [32.36]	1.534 [38.96]		0.450 [11.43]	0.605 [15.37]	1.322 [33.58]	0.539 [13.69]	0.230 [5.84]	0.426 [10.82]
ORD 29 F ORD 29 S	1.770 [44.96]	1.251 [31.78]		1.534 [38.96]	0.431 [10.95]		0.605 [15.37]	1.322 [33.58]	0.539 [13.69]	0.237 [6.02]	0.429 [10.90]
ORD 37 M	2.729 [69.32]		2.182 [55.42]	2.500 [63.50]		0.329 [8.36]	0.494 [12.55]	2.272 [57.71]	0.422 [10.72]	0.230 [5.84]	0.426 [10.82]
ORD 37 F ORD 37 S	2.729 [69.32]	2.159 [54.84]		2.500 [63.50]	0.311 [7.90]		0.494 [12.55]	2.272 [57.71]	0.422 [10.72]	0.243 [6.17]	0.429 [10.90]
ORD 50 M	2.635 [66.93]		2.079 [52.81]	2.406 [61.11]		0.441 [11.20]	0.605 [15.37]	2.178 [55.32]	0.534 [13.56]	0.230 [5.84]	0.426 [10.82]
ORD 50 F ORD 50 S	2.635 [66.93]	2.064 [52.43]		2.406 [61.11]	0.423 [10.74]		0.605 [15.37]	2.178 [55.32]	0.534 [13.56]	0.243 [6.17]	0.429 [10.90]

ORD SERIES



**REMOVABLE CRIMP CONTACTS**  
**CODE 1**

CONTACTS MAY BE SUPPLIED WITH CONNECTOR OR ORDERED SEPARATELY.



Note: Connectors can be kitted with all applicable crimp/solder contacts, contact Technical Sales for connector part number.

**FEMALE CONTACT**  
"CLOSED ENTRY" DESIGN

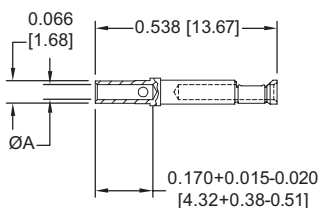

**MALE CONTACT**

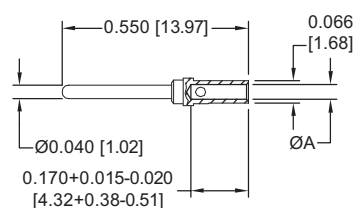

FEMALE PART NUMBER	WIRE SIZE AWG/[mm <sup>2</sup> ]	ØA
FC6020D2	20 / 22 / 24 [0.5/0.3/0.25]	0.045 [1.14]
FC6026D2	26 / 28 / 30 [0.12/0.08/0.05]	0.027 [0.69]

MALE PART NUMBER	WIRE SIZE AWG/[mm <sup>2</sup> ]	ØA
MC6020D	20 / 22 / 24 [0.5/0.3/0.25]	0.045 [1.14]
MC6026D	26 / 28 / 30 [0.12/0.08/0.05]	0.027 [0.69]

**PLATING:**

**STANDARD FINISH:** Gold flash over nickel plate.

**OPTIONAL FINISHES:** 0.000030 [0.76] gold over nickel by adding "-14" suffix onto part number. Example: FC6120D2-14  
0.000050 inch [1.27] gold over nickel by adding "-15" suffix onto part number. Example: MC6026D-15

**REMOVABLE CRIMP CONTACTS**  
**CODE 1**

CONTACTS MAY BE SUPPLIED WITH CONNECTOR OR ORDERED SEPARATELY.

**FEMALE CONTACT**  
"RUGGED OPEN ENTRY" DESIGN

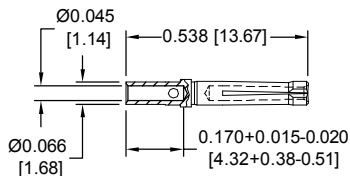

Note: Connectors can be kitted with all applicable crimp/solder contacts, contact Technical Sales for connector part number.

FEMALE PART NUMBER	WIRE SIZE AWG/[mm <sup>2</sup> ]
FC6120D	20 / 22 / 24 [0.5/0.3/0.25]

**PLATING:**

**STANDARD FINISH:** Gold flash over nickel plate.

**OPTIONAL FINISHES:** 0.000030 [0.76] gold over nickel by adding "-14" suffix onto part number. Example: FC6120D-14  
0.000050 inch [1.27] gold over nickel by adding "-15" suffix onto part number. Example: FC6120D-15

For information regarding **CRIMP TOOLS & CRIMPING TOOL TECHNIQUES**, see page 78.

ORD SERIES



Positronic  
connectpositronic.com

# PROFESSIONAL / INDUSTRIAL QUALITY REMOVABLE CONTACT STANDARD DENSITY D-SUBMINIATURE

D-Sub

The crimp area of this contact is not protected when fully seated in the connector tubing molding. These contacts require shrink tubing after installation. Wire cannot be removed from molding after insertion. Not suitable for fully loaded connector.

## REMOVABLE CRIMP CONTACTS 18 AWG CRIMP CONTACTS

18 AWG [1.0mm<sup>2</sup>]

Note: Connectors can be kitted with all applicable crimp/solder contacts, contact Technical Sales for connector part number.

CONTACTS MAY BE SUPPLIED WITH CONNECTOR OR ORDERED SEPARATELY.

### \*FEMALE CONTACT

"RUGGED OPEN ENTRY" DESIGN

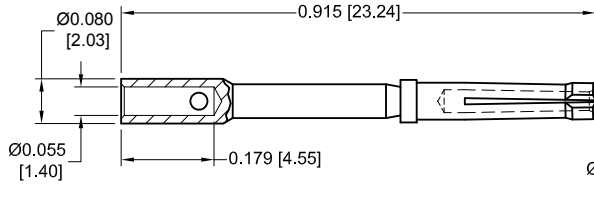

FC6118D

### MALE CONTACT

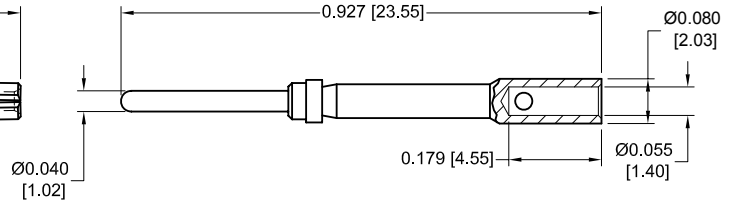

MC6018D

\* FEMALE POSIBAND CLOSED ENTRY CONTACTS ARE AVAILABLE, SEE PAGE 36 FOR DETAILS.

### PLATING:

**STANDARD FINISH:** Gold flash over nickel plate.

**OPTIONAL FINISHES:** 0.000030 [0.76] gold over nickel by adding "-14" suffix onto part number. Example: FC6118D-14

0.000050 inch [1.27] gold over nickel by adding "-15" suffix onto part number. Example: MC6018D-15

## REMOVABLE THERMOCOUPLE CRIMP CONTACTS

CONTACTS MAY BE SUPPLIED WITH CONNECTOR OR ORDERED SEPARATELY.

Note: Connectors can be kitted with all applicable crimp/solder contacts, contact Technical Sales for connector part number.

### FEMALE CONTACT

"CLOSED ENTRY" DESIGN

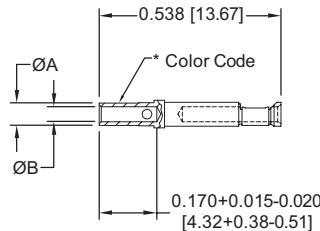

### MALE CONTACT

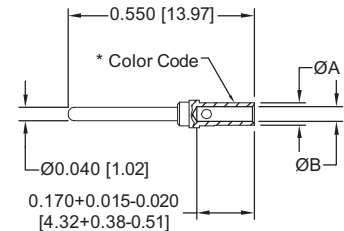

TYPE	MATERIAL	FEMALE PART NUMBER	MALE PART NUMBER	COLOR CODE	WIRE SIZE AWG [mm <sup>2</sup> ]	ØA	ØB
K	CHROMEL (+)	FC6020D2CH <sup>††</sup>	MC6020DCH <sup>†</sup>	WHITE	20 / 22 / 24 [0.5 / 0.3 / 0.25]	0.066 [1.68]	0.045 [1.14]
		FC6026D2CH	MC6026DCH		26 / 28 / 30 [0.12 / 0.08 / 0.05]	0.048 [1.23]	0.027 [0.69]
	ALUMEL (-)	FC6020D2AL <sup>††</sup>	MC6020DAL <sup>†</sup>	GREEN	20 / 22 / 24 [0.5 / 0.3 / 0.25]	0.066 [1.68]	0.045 [1.14]
		FC6026D2AL	MC6026DAL		26 / 28 / 30 [0.12 / 0.08 / 0.05]	0.048 [1.23]	0.027 [0.69]
T	COPPER (+) with gold flash	FC6020D2CU <sup>††</sup>	MC6020DCU <sup>†</sup>	RED	20 / 22 / 24 [0.5 / 0.3 / 0.25]	0.066 [1.68]	0.045 [1.14]
		FC6026D2CU	MC6026DCU		26 / 28 / 30 [0.12 / 0.08 / 0.05]	0.048 [1.23]	0.027 [0.69]
	CONSTANTAN (-)	FC6020D2C0 <sup>††</sup>	MC6020DC0 <sup>†</sup>	YELLOW	20 / 22 / 24 [0.5 / 0.3 / 0.25]	0.066 [1.68]	0.045 [1.14]
		FC6026D2C0	MC6026DC0		26 / 28 / 30 [0.12 / 0.08 / 0.05]	0.048 [1.23]	0.027 [0.69]
E	CHROMEL (+)	FC6020D2CH <sup>††</sup>	MC6020DCH <sup>†</sup>	WHITE	20 / 22 / 24 [0.5 / 0.3 / 0.25]	0.066 [1.68]	0.045 [1.14]
		FC6026D2CH	MC6026DCH		26 / 28 / 30 [0.12 / 0.08 / 0.05]	0.048 [1.23]	0.027 [0.69]
	CONSTANTAN (-)	FC6020D2C0 <sup>††</sup>	MC6020DC0 <sup>†</sup>	YELLOW	20 / 22 / 24 [0.5 / 0.3 / 0.25]	0.066 [1.68]	0.045 [1.14]
		FC6026D2C0	MC6026DC0		26 / 28 / 30 [0.12 / 0.08 / 0.05]	0.048 [1.23]	0.027 [0.69]

For more information on the availability of Type J thermocouple contacts, and information about thermocouple contacts with printed circuit board solder termination, please contact Technical Sales.

Chromel<sup>®</sup> and Alumel<sup>®</sup> are registered trademarks of Hoskins Manufacturing Company.

<sup>††</sup>Dimensionally equivalent to M39029/64-369

<sup>††</sup>Dimensionally equivalent to M39029/63-368

For information regarding **CRIMP TOOLS & CRIMPING TOOL TECHNIQUES**, see page 78.





**ORDERING INFORMATION - CODE NUMBERING SYSTEM**

Specify Complete Connector By Selecting An Option From Step 1 Through 8

STEP	1	2	3	4	5	6	7	8	9	10
EXAMPLE	ORD	9	M	0	0	0	0	Z	/AA	-14
<b>STEP 1 - BASIC SERIES</b> ORD series										<b>STEP 10 - SPECIAL OPTIONS</b> -14 - 0.000030 [0.76µ] gold over nickel. -15 - 0.000050 [1.27µ] gold over nickel. <b>CONTACT TECHNICAL SALES FOR SPECIAL OPTIONS</b>
<b>STEP 2 - CONNECTOR VARIANTS</b> 9, 15, 25, 29, 37, 50										<b>STEP 9 - ENVIRONMENTAL COMPLIANCE OPTIONS</b>  /AA - RoHS Compliant  <b>NOTE:</b> If compliance to environmental legislation is not required, this step will not be used. Example: ORD9M0000Z
<b>STEP 3 - CONNECTOR GENDER</b>  M - Male F - Female - Professional Level open entry contacts S - Female - Industrial Level PosiBand closed entry contacts										<b>STEP 8 - Shell Options</b> 0 - Zinc plated, with chromate seal. C - Cadmium plated with chromate seal. *3S - Stainless steel, passivated. X - Tin plated. Z - Tin plated and dimpled (male connectors only).
<b>STEP 4 - CONTACT TERMINATION TYPE</b> 0 - Contacts ordered separately, see pages 40-41. 1 - Crimp, 20 AWG-24 AWG [0.5mm <sup>2</sup> -0.25mm <sup>2</sup> ].										<b>*1 STEP 7 - LOCKING AND POLARIZING SYSTEMS</b> 0 - None. *2 V3 - Lock Tab, connector front panel mounted. *2 V5 - Lock Tab, connector rear panel mounted. *2 VL - Lock Lever, used with Hoods Only. T - Fixed Female Jackscrews. T2 - Fixed Female Jackscrews. T6 - Fixed Male and Female Polarized Jackscrews. E - Rotating Male Jackscrews. E2 - Rotating Male Screw Locks. E3 - Rotating Male with internal hex for 3/32 hex drives E6 - Rotating Male and Female Polarized Jackscrews.
<b>*1 STEP 5 - MOUNTING STYLE</b> 0 - Mounting Hole, 0.120 [3.05] Ø. 02 - Mounting Hole, 0.154 [3.91] Ø. F - Float Mounts, Universal. S2 - Swaged Spacer, 4-40 Threads, 0.125 [3.18] Length. S5 - Swaged Locknut, 4-40 Threads.										
<b>*1 STEP 6 - HOODS</b> 0 - None. J - Hood, Top Opening, Plastic. L - Hood, Side Opening, Plastic. Y - Hood, Top Opening, Plastic with Rotating Male Jackscrews. Available in size 50 only. Y6 - Hood, Top Opening, Plastic with Rotating Male and Female Polarized Jackscrews. Available in size 50 only. Z - Hood, Top or Side Opening, Robust Extended Height, Composite and Plastic with Rotating Male Jackscrews. Available in size 9, 15, 25, 37, and 50 only. H - Hood, Top Opening, Metal. Available in size 15, 25, 37, and 50 only. G - Hood, EMI/RFI, Die Cast Zinc. Available in size 9, 15, 25, 37, and 50 only. *4 AN - Lightweight Aluminum Hood, nickel finish. *4 AC - Lightweight Aluminum Hood, no finish. W - Hood, Top or Side Opening, Plastic. Available in size 9, 15, and 25 only.										

ORD SERIES

\*1 For additional information on accessories listed in steps 5, 6 and 7, see Accessory Catalog.  
\*2 VL, V3 and V5 locking systems are not available for connector variants 37 and 50. Jackscrews are highly recommended to minimize damage to contacts on variants with high mating forces.  
\*3 For stainless steel dimpled male versions contact Technical Sales.  
\*4 AN and AC hood are not available for connector variant 29. Consult Technical Sales for availability.

For information regarding **CRIMP TOOLS & CRIMPING TOOL TECHNIQUES**, see page 78.

**NOTE:** Once you have made a connector selection, contact Technical Sales if you would like to receive a drawing in DXF, PDF format or a 3-dimensional IGES, STEP, or SOLIDWORKS file.

2-D Drawing

3-D Model



Positronic  
connectpositronic.com

# PROFESSIONAL / INDUSTRIAL QUALITY FIXED AND REMOVABLE CONTACTS HIGH DENSITY D-SUBMINIATURE

D-Sub

**Size 22 Contacts,  
Removable Crimp and  
Solder Printed Board Mount**

**Two Performance Levels For  
Best Cost / Performance Ratio**

UL Recognized  
File #E49351

CSA Recognized  
File #LR54219

Telecommunication  
UL File #E140980



ODD series connectors are professional / industrial quality high density connectors recommended for use in sheltered, non-corrosive indoor environments having normal ventilation.

ODD series connectors utilize precision machined, removable contacts having closed barrel crimp terminations and solder cup wire terminations. For printed board mount application, straight solder

printed board mount and right angle (90°) angled solder terminations are available.

Six standard contact variants are offered in arrangements of 15, 26, 44, 62, 78, and 104 contacts. ODD series connectors are mateable and compatible with other high density D-subminiature connectors conforming to MIL-DTL-24308, and are UL and CSA recognized.

A wide variety of unique accessories are available.

## ODD SERIES TECHNICAL CHARACTERISTICS

### MATERIALS AND FINISHES:

<b>Insulators:</b>	Glass filled polyester per ASTM D5927, UL 94V-0, black color.
<b>Contacts:</b>	Precision machined copper alloy.
<b>Contact Plating:</b>	Professional quality - gold flash over nickel plate. Other finishes available upon request.
<b>Shells:</b>	Steel with tin plate; zinc plate with chromate seal, stainless steel passivated. Other materials and finishes available upon request.
<b>Mounting Spacers:</b>	Nylon; copper alloy or steel with zinc plate and chromate seal or tin plate; phosphor bronze with tin plate; stainless steel, passivated.
<b>Vibration Lock Systems:</b>	Slide lock and lock tabs, steel with nickel plate.
<b>Push-On Fasteners:</b>	Phosphor bronze or beryllium copper with tin plate.
<b>Jackscrew Systems:</b>	Brass or steel with zinc plate and chromate seal or clear zinc plate or tin plate; stainless steel, passivated.
<b>Hoods:</b>	Composite and plastic, UL 94V-0; brass or steel with zinc plate and chromate seal. Aluminum; aluminum with electroless nickel plate. For aluminum hoods, zinc content is 1% maximum. Die cast zinc.

Low magnetic versions are available, contact Technical Sales.

### MECHANICAL CHARACTERISTICS:

<b>Removable Contacts:</b>	Insert contact to rear face of insulator and release from rear face of insulator. Size 22 contact, male - 0.030 inch [0.76mm] mating diameter. Female - rugged open entry design or PosiBand closed entry design, see page 1 for details.
<b>Fixed Contacts, Board Mounted Applications:</b>	Female open entry contacts - both rugged and standard design available to customer requirements. Closed entry contacts are PosiBand design, see page 1 for details.
<b>Contact Retention In Insulator:</b>	9 lbs. [40 N].
<b>Contact Terminations:</b>	Closed barrel crimp, wire sizes 22 AWG

[0.3mm<sup>2</sup>] through 30 AWG [0.05mm<sup>2</sup>]. Solder cup wire, 0.035 inch [0.89mm] hole diameter for 22 AWG [0.3mm<sup>2</sup>] wire maximum.

0.020 inch [0.5mm] or 0.030 inch [0.76mm] termination diameter straight and Right Angle (90°) printed board mount contact terminations.

<b>Shells:</b>	Male shells may be dimpled for EMI/ESD ground paths.
<b>Polarization:</b>	Trapezoidally shaped shells and polarized jackscrews.
<b>Mounting To Angle Brackets:</b>	Jackscrews and riveted fasteners with 0.120 inch [3.05mm] clearance hole, and threaded riveted fasteners with 4-40 threads and polyester lock inserts.
<b>Mounting To Printed Board:</b>	Rapid installation push-on fasteners and mounting posts.
<b>Locking Systems:</b>	Jackscrews and vibration locking systems.
<b>Mechanical Operations:</b>	500 operations minimum per IEC 60512-5 for open entry female contact. 1000 operations minimum per IEC 60512-5 for PosiBand closed entry female contact.

### ELECTRICAL CHARACTERISTICS:

<b>Contact Current Rating:</b>	
<b>Open Entry Contacts:</b>	5 amperes nominal
<b>Closed Entry Contacts, tested per UL 1977:</b>	12 amperes, 2 contacts energized. 10 amperes, 6 contacts energized. 7.5 amperes, 26 contacts energized. 6.5 amperes, 62 contacts energized. 5.0 amperes, 104 contacts energized.
	<i>See temperature rise curves on page 2 for details.</i>
<b>Initial Contact Resistance:</b>	0.010 ohms maximum for open entry. 0.005 ohms maximum for closed entry.
<b>Proof Voltage:</b>	1000 V r.m.s.
<b>Insulation Resistance:</b>	5 G ohms.
<b>Clearance and Creepage Distance [minimum]:</b>	0.042 inch [1.06mm].
<b>Working Voltage:</b>	300 V r.m.s.

### CLIMATIC CHARACTERISTICS:

<b>Temperature Range:</b>	-55°C to +125°C.
<b>Damp Heat, Steady State:</b>	10 days.

ODD SERIES



**CONTACT VARIANTS**

FACE VIEW OF MALE OR REAR VIEW OF FEMALE

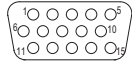

ODD 15

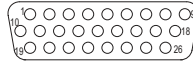

ODD 26

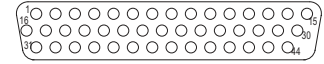

ODD 44

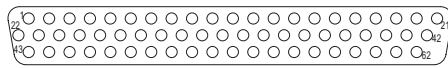

ODD 62

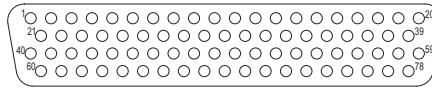

ODD 78

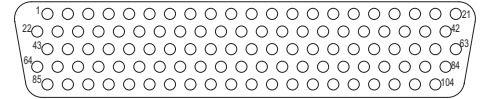

ODD 104

**STANDARD SHELL ASSEMBLY**

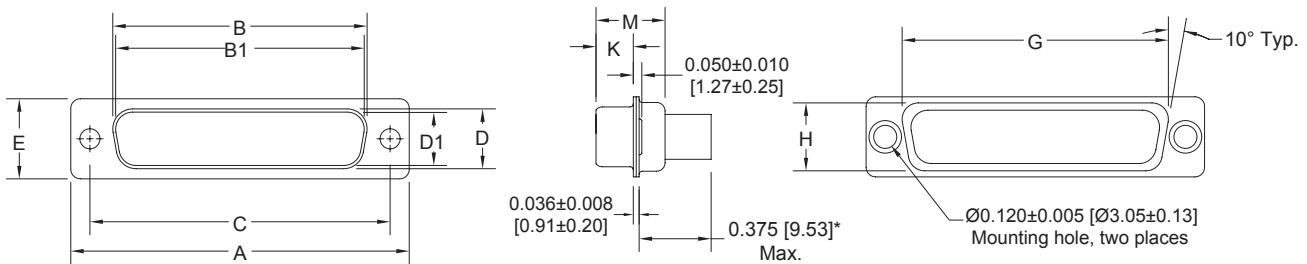

\* This dimension is for crimp removable connectors. 0.220 [5.59] maximum for all other connectors.

**OPTIONAL SHELL ASSEMBLY [0, 02]**

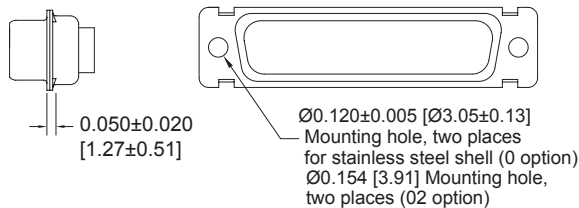

**OPTIONAL SHELL ASSEMBLY WITH UNIVERSAL FLOAT MOUNTS [F]**

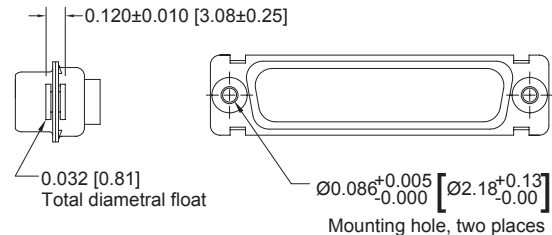

CONNECTOR VARIANT SIZES	A ±0.015 [0.38]	B ±0.005 [0.13]	B1 ±0.005 [0.13]	C ±0.005 [0.13]	D ±0.005 [0.13]	D1 ±0.005 [0.13]	E ±0.015 [0.38]	G ±0.010 [0.25]	H ±0.010 [0.25]	K ±0.005 [0.13]	M ±0.010 [0.25]
ODD 15 M	1.213 [30.81]		0.666 [16.92]	0.984 [24.99]		0.329 [8.36]	0.494 [12.55]	0.759 [19.28]	0.422 [10.72]	0.233 [5.92]	0.422 [10.72]
ODD 15 F ODD 15 S	1.213 [30.81]	0.643 [16.33]		0.984 [24.99]	0.311 [7.90]		0.494 [12.55]	0.759 [19.28]	0.422 [10.72]	0.243 [6.17]	0.429 [10.90]
ODD 26 M	1.541 [39.14]		0.994 [25.25]	1.312 [33.32]		0.329 [8.36]	0.494 [12.55]	1.083 [27.51]	0.422 [10.72]	0.233 [5.92]	0.422 [10.72]
ODD 26 F ODD 26 S	1.541 [39.14]	0.971 [24.66]		1.312 [33.32]	0.311 [7.90]		0.494 [12.55]	1.083 [27.51]	0.422 [10.72]	0.243 [6.17]	0.429 [10.90]
ODD 44 M	2.088 [53.04]		1.534 [38.96]	1.852 [47.04]		0.329 [8.36]	0.494 [12.55]	1.625 [41.28]	0.422 [10.72]	0.230 [5.84]	0.426 [10.82]
ODD 44 F ODD 44 S	2.088 [53.04]	1.511 [38.38]		1.852 [47.04]	0.311 [7.90]		0.494 [12.55]	1.625 [41.28]	0.422 [10.72]	0.243 [6.17]	0.429 [10.90]
ODD 62 M	2.729 [69.32]		2.182 [55.42]	2.500 [63.50]		0.329 [8.36]	0.494 [12.55]	2.272 [57.71]	0.422 [10.72]	0.230 [5.84]	0.426 [10.82]
ODD 62 F ODD 62 S	2.729 [69.32]	2.159 [54.84]		2.500 [63.50]	0.311 [7.90]		0.494 [12.55]	2.272 [57.71]	0.422 [10.72]	0.243 [6.17]	0.429 [10.90]
ODD 78 M	2.635 [66.93]		2.079 [52.81]	2.406 [61.11]		0.441 [11.20]	0.605 [15.37]	2.178 [55.32]	0.534 [13.56]	0.230 [5.84]	0.426 [10.82]
ODD 78 F ODD 78 S	2.635 [66.93]	2.064 [52.43]		2.406 [61.11]	0.423 [10.74]		0.605 [15.37]	2.178 [55.32]	0.534 [13.56]	0.243 [6.17]	0.429 [10.90]
ODD 104 M	2.729 [69.32]		2.212 [56.18]	2.500 [63.50]		0.503 [12.78]	0.668 [16.97]	2.302 [58.47]	0.596 [15.14]	0.230 [5.84]	0.426 [10.82]
ODD 104 F ODD 104 S	2.729 [69.32]	2.189 [55.60]		2.500 [63.50]	0.485 [12.32]		0.668 [16.97]	2.302 [58.47]	0.596 [15.14]	0.243 [6.17]	0.429 [10.90]



**REMOVABLE CRIMP CONTACTS  
CODE 1**

CONTACTS MAY BE SUPPLIED WITH CONNECTOR OR ORDERED SEPARATELY.

Note: Connectors can be kitted with all applicable crimp/solder contacts, contact Technical Sales for connector part number.

**FEMALE CONTACT**

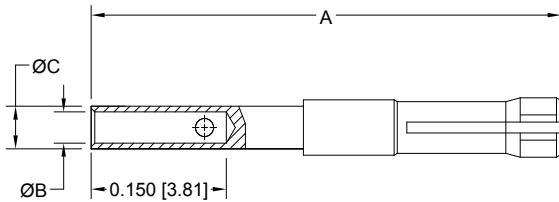

Part Number: FC8122D

FEMALE PART NUMBER	WIRE SIZE AWG/[mm <sup>2</sup> ]	A	ØB	ØC
FC8122D	22 / 24 / 26 / 28 / 30 [0.3/0.25/0.12/0.08/0.05]	0.529 [13.44]	0.035 [0.89]	0.047 [1.19]

**MALE CONTACT**

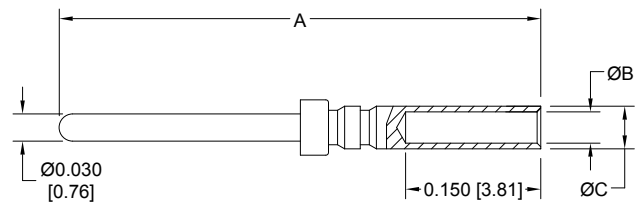

Part Number: MC8022D

MALE PART NUMBER	WIRE SIZE AWG/[mm <sup>2</sup> ]	A	ØB	ØC
MC8022D	22 / 24 / 26 / 28 / 30 [0.3/0.25/0.12/0.08/0.05]	0.531 [13.49]	0.035 [0.89]	0.047 [1.19]

**PLATING:**

**STANDARD FINISH:** Gold flash over nickel plate.

**OPTIONAL FINISHES:** 0.000030 [0.76] gold over nickel by adding "-14" suffix onto part number. Example: FC8122D-14

0.000050 inch [1.27] gold over nickel by adding "-15" suffix onto part number. Example: MC8022D-15

**REMOVABLE CRIMP CONTACTS  
CODE 1**

CONTACTS MAY BE SUPPLIED WITH CONNECTOR OR ORDERED SEPARATELY.



**FEMALE CONTACT**

"CLOSED ENTRY" DESIGN

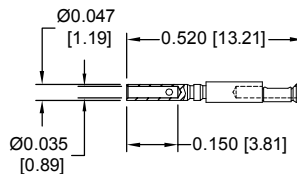

Note: Connectors can be kitted with all applicable crimp/solder contacts, contact Technical Sales for connector part number.

FEMALE PART NUMBER	WIRE SIZE AWG/[mm <sup>2</sup> ]
FC8022D2	22 / 24 / 26 / 28 / 30 [0.3/0.25/0.12/0.08/0.05]

**PLATING:**

**STANDARD FINISH:** Gold flash over nickel plate.

**OPTIONAL FINISHES:** 0.000030 [0.76] gold over nickel by adding "-14" suffix onto part number. Example: FC8022D2-14

0.000050 inch [1.27] gold over nickel by adding "-15" suffix onto part number. Example: FC8022D2-15

For information regarding **CRIMP TOOLS & CRIMPING TOOL TECHNIQUES**, see page 78.



The crimp area of this contact is not protected when fully seated in the connector molding. These contacts require shrink tubing after installation. Wire cannot be removed from molding after insertion. Not suitable for fully loaded connector.

**REMOVABLE CRIMP CONTACTS**  
**20 AWG CONTACTS**  
20 AWG [0.5 mm<sup>2</sup>]

Note: Connectors can be kitted with all applicable crimp/solder contacts, contact Technical Sales for connector part number.

CONTACTS MAY BE SUPPLIED WITH CONNECTOR OR ORDERED SEPARATELY.

**\*FEMALE CONTACT**

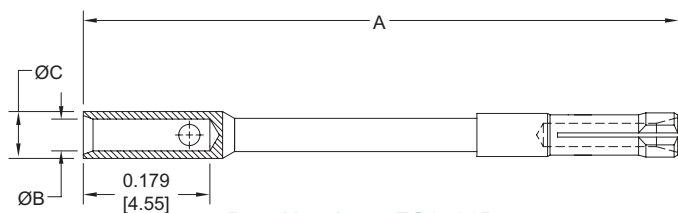

Part Number: FC8120D

**MALE CONTACT**

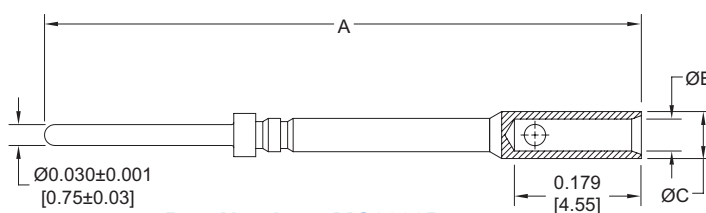

Part Number: MC8020D

FEMALE PART NUMBER	WIRE SIZE AWG/[mm <sup>2</sup> ]	A	ØB	ØC
FC8120D	20 [0.5] max	0.852 [21.64]	0.045 [1.14]	0.066 [1.68]

MALE PART NUMBER	WIRE SIZE AWG/[mm <sup>2</sup> ]	A	ØB	ØC
MC8020D	20 [0.5] max	0.853 [21.66]	0.045 [1.14]	0.066 [1.68]

\* FEMALE POSIBAND CLOSED ENTRY CONTACTS ARE AVAILABLE, SEE PAGE 56 FOR DETAILS.

**PLATING:**

**STANDARD FINISH:** Gold flash over nickel plate.

**OPTIONAL FINISHES:** 0.000030 [0.76] gold over nickel by adding "-14" suffix onto part number. Example: FC8120D-14  
0.000050 inch [1.27] gold over nickel by adding "-15" suffix onto part number. Example: MC8020D-15

**REMOVABLE THERMOCOUPLE CRIMP CONTACTS**

CONTACTS MAY BE SUPPLIED WITH CONNECTOR OR ORDERED SEPARATELY.



Note: Connectors can be kitted with all applicable crimp/solder contacts, contact Technical Sales for connector part number.

**FEMALE CONTACT**

"CLOSED ENTRY" DESIGN

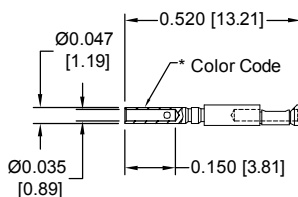

**MALE CONTACT**

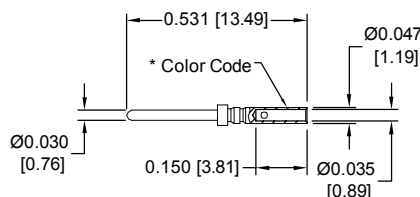

TYPE	MATERIAL	FEMALE PART NUMBER	MALE PART NUMBER	COLOR CODE*	WIRE SIZE AWG [mm <sup>2</sup> ]
K	CHROMEL (+)	FC8022D2CH	MC8022DCH	WHITE	22 / 24 / 26 [ 0.3 / 0.25 / 0.12]
	ALUMEL (-)	FC8022D2AL	MC8022DAL	GREEN	22 / 24 / 26 [ 0.3 / 0.25 / 0.12]
T	COPPER (+) with gold flash	FC8022D2CU	MC8022DCU	RED	22 / 24 / 26 [ 0.3 / 0.25 / 0.12]
	CONSTANTAN (-)	FC8022D2CO	MC8022DCO	YELLOW	22 / 24 / 26 [ 0.3 / 0.25 / 0.12]
E	CHROMEL (+)	FC8022D2CH	MC8022DCH	WHITE	22 / 24 / 26 [ 0.3 / 0.25 / 0.12]
	CONSTANTAN (-)	FC8022D2CO	MC8022DCO	YELLOW	22 / 24 / 26 [ 0.3 / 0.25 / 0.12]

For more information on the availability of Type J thermocouple contacts, please contact Technical Sales.

For more information about thermocouple contacts with printed circuit board solder termination, please contact Technical Sales.

Chromel® and Alumel® are registered trademarks of Hoskins Manufacturing Company

For information regarding **CRIMP TOOLS & CRIMPING TOOL TECHNIQUES**, see page 78.

ODD SERIES



Positronic  
connectpositronic.com

PROFESSIONAL / INDUSTRIAL QUALITY  
FIXED AND REMOVABLE CONTACTS  
HIGH DENSITY D-SUBMINIATURE

D-Sub

REMOVABLE SOLDER CUP CONTACTS  
CODE 2

CONTACTS MAY BE SUPPLIED WITH CONNECTOR OR ORDERED SEPARATELY.

Note: Connectors can be kitted with all applicable crimp/solder contacts, contact Technical Sales for connector part number.

FEMALE CONTACT

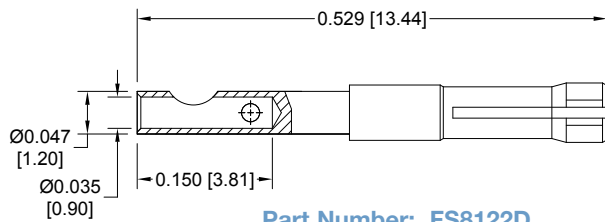

MALE CONTACT

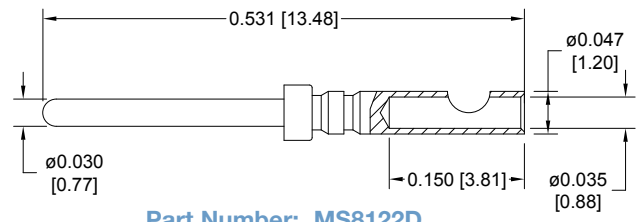

PLATING:

**STANDARD FINISH:** Gold flash over nickel plate.

**OPTIONAL FINISHES:** 0.000030 [0.76] gold over nickel by adding "-14" suffix onto part number. Example: FS8122D-14  
0.000050 inch [1.27] gold over nickel by adding "-15" suffix onto part number. Example: MS8122D-15

REMOVABLE SOLDER CUP CONTACTS  
CODE 2

CONTACTS MAY BE SUPPLIED WITH CONNECTOR OR ORDERED SEPARATELY.

Note: Connectors can be kitted with all applicable crimp/solder contacts, contact Technical Sales for connector part number.



FEMALE CONTACT

"CLOSED ENTRY" DESIGN

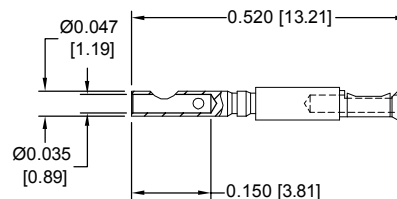

FEMALE PART NUMBER	WIRE SIZE AWG/[mm <sup>2</sup> ]
FS8022D2	22 [0.3] max

PLATING:

**STANDARD FINISH:** Gold flash over nickel plate.

**OPTIONAL FINISHES:** 0.000030 [0.76] gold over nickel by adding "-14" suffix onto part number. Example: FS8022D2-14  
0.000050 inch [1.27] gold over nickel by adding "-15" suffix onto part number. Example: FS8022D2-15

For information regarding **INSERTION & REMOVAL TOOLS**, see page 78.



**FIXED SOLDER CUP TERMINATION  
CODE 21**

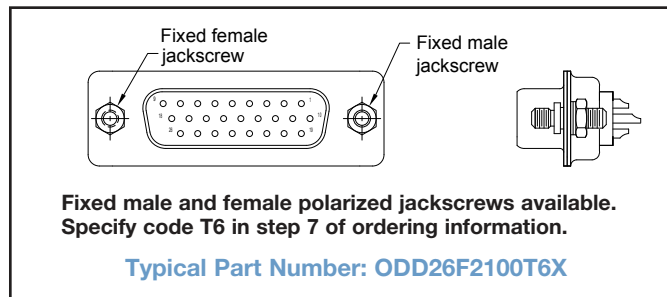
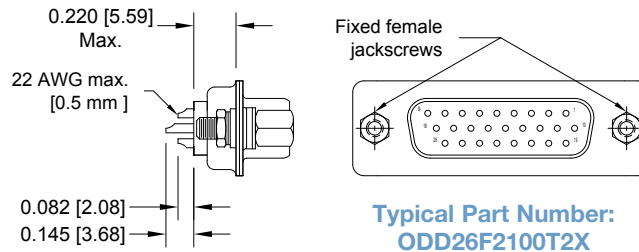

**STRAIGHT PRINTED BOARD MOUNT TERMINATION  
CODE 3 AND 32**

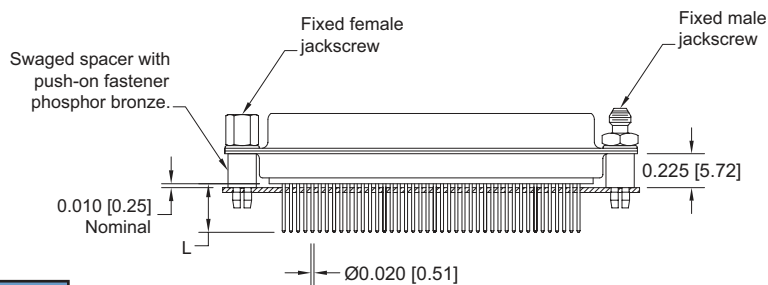

Code No.	L
3	0.150 [3.81]
32	0.300 [7.62]

For straight printed board mount contacts specify code no. in step 4 of ordering information

**Typical Part Number: ODD62F3S60T6X**



Positronic  
connectpositronic.com

PROFESSIONAL / INDUSTRIAL QUALITY  
FIXED AND REMOVABLE CONTACTS  
HIGH DENSITY D-SUBMINIATURE

D-Sub

RIGHT ANGLE (90°) PRINTED BOARD MOUNT TERMINATION

CODE 5, 0.450 [11.43] CONTACT EXTENSION

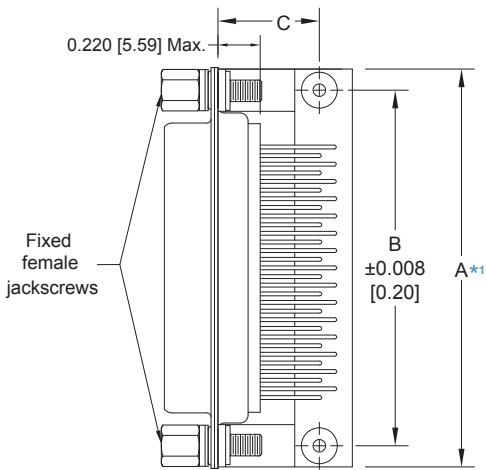

ODD**5**** 0.450 [11.43] CONTACT EXTENSION				
PART NUMBER	A*1	B	C	D
ODD15*5****	1.204 [30.58]	0.984 [24.99]	0.528 [13.41]	0.450 [11.43]
ODD26*5****	1.532 [38.91]	1.312 [33.32]	0.528 [13.41]	0.450 [11.43]
ODD44*5****	2.072 [52.63]	1.852 [47.04]	0.528 [13.41]	0.450 [11.43]
ODD62*5****	2.720 [69.09]	2.500 [63.50]	0.528 [13.41]	0.450 [11.43]
ODD78*5****	2.626 [66.70]	2.406 [61.11]	0.573 [14.55]	0.450 [11.43]

See next page for size 104 Right Angle (90°) Connectors.

NOTE:

\*1 "A" dimension applies for metal angle brackets only. Consult Accessories D-subminiature catalog for "A" dimension when plastic brackets are used.

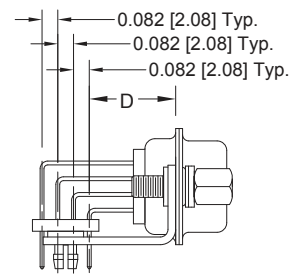
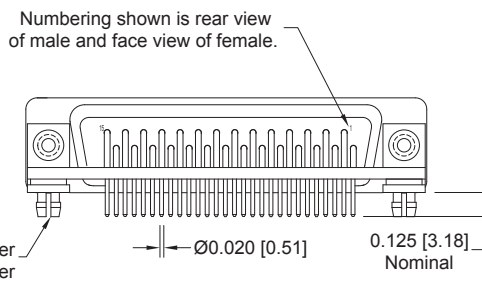
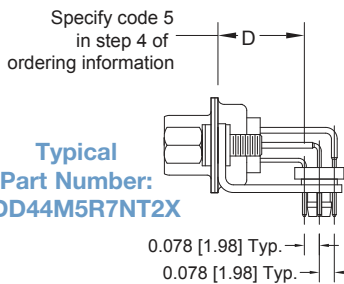

RIGHT ANGLE (90°) PRINTED BOARD MOUNT TERMINATION

CODE 4, 0.314 [7.98] CONTACT EXTENSION

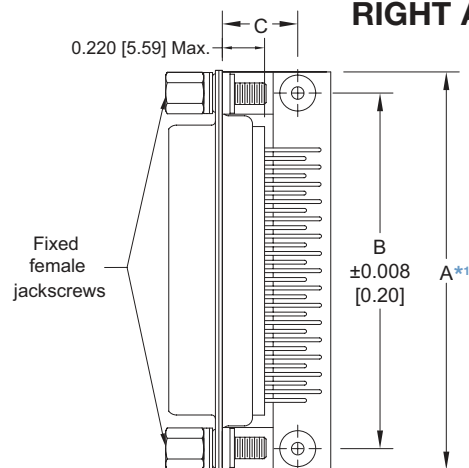

ODD**4**** 0.314 [7.98] CONTACT EXTENSION				
PART NUMBER	A*1	B	C	D
ODD15*4****	1.204 [30.58]	0.984 [24.99]	0.414 [10.52]	0.314 [7.98]
ODD26*4****	1.532 [38.91]	1.312 [33.32]	0.414 [10.52]	0.314 [7.98]
ODD44*4****	2.072 [52.63]	1.852 [47.04]	0.414 [10.52]	0.314 [7.98]
ODD62*4****	2.720 [69.09]	2.500 [63.50]	0.414 [10.52]	0.314 [7.98]
ODD78*4****	2.626 [66.70]	2.406 [61.11]	0.414 [10.52]	0.314 [7.98]

See next page for size 104 Right Angle (90°) Connectors.

NOTE:

\*1 "A" dimension applies for metal angle brackets only. Consult Accessories D-subminiature catalog for "A" dimension when plastic brackets are used.

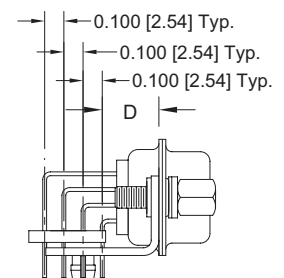
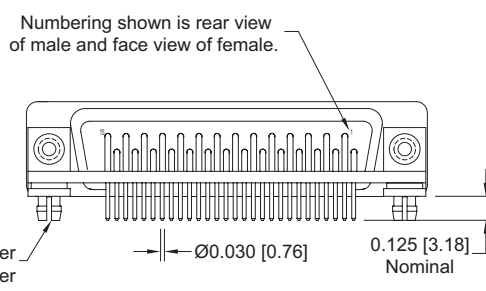
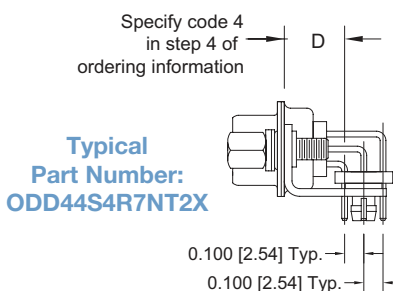

ODD SERIES





**RIGHT ANGLE (90°) PRINTED BOARD MOUNT TERMINATION**

**CODE 5, 0.450 [11.43] CONTACT EXTENSION**  
**CONTACT VARIANT 104**

Typical Part Number:  
ODD104M5R7NT2X

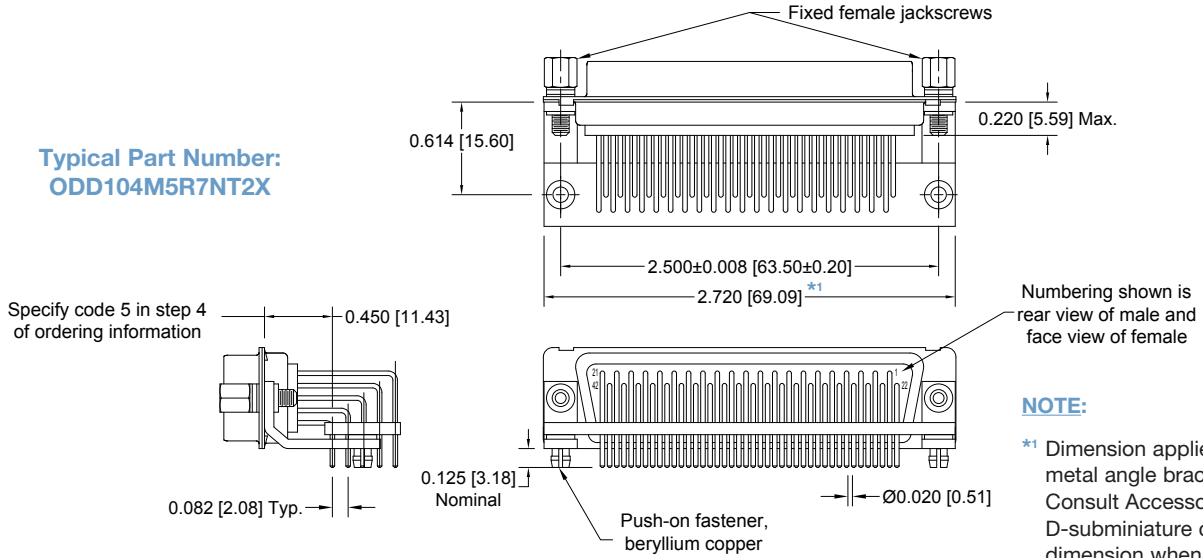

**NOTE:**

\*1 Dimension applies for metal angle brackets only. Consult Accessories D-subminiature catalog for dimension when plastic brackets are used.

**RIGHT ANGLE (90°) PRINTED BOARD MOUNT TERMINATION**

**CODE 4, 0.314 [7.98] CONTACT EXTENSION**  
**CONTACT VARIANT 104**

Typical Part Number:  
ODD104M4R7NT2X

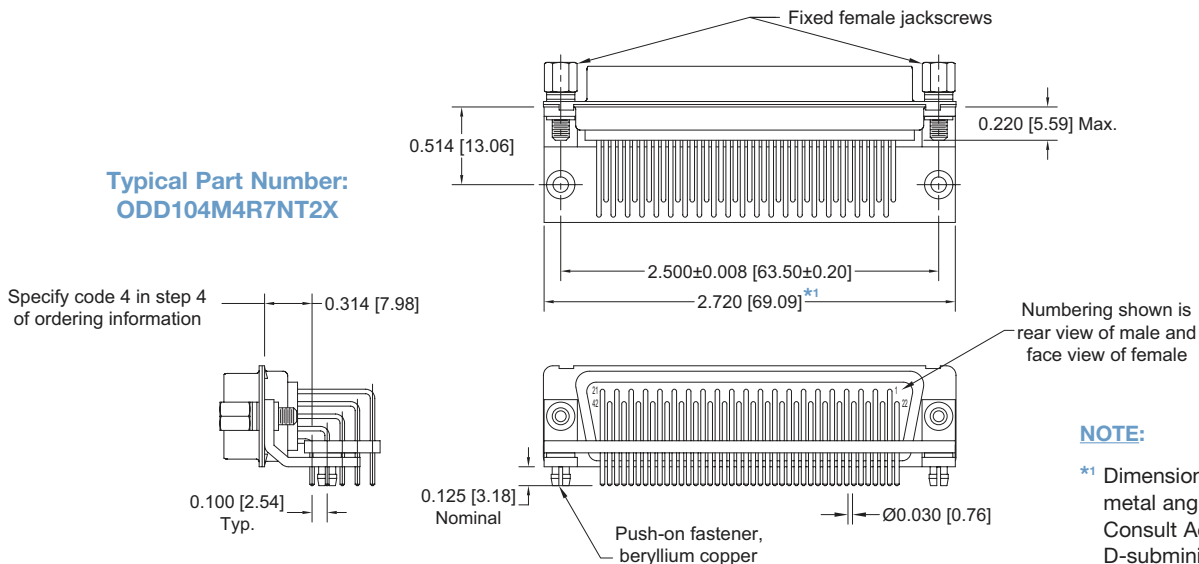

**NOTE:**

\*1 Dimension applies for metal angle brackets only. Consult Accessories D-subminiature catalog for dimension when plastic brackets are used.



**RIGHT ANGLE (90°) AND STRAIGHT PRINTED BOARD CONTACT HOLE PATTERN**

MOUNT CONNECTOR WITH MATING FACE POSITIONED TO FOLLOW DIRECTION OF ARROWS.

**ODD15 MALE**

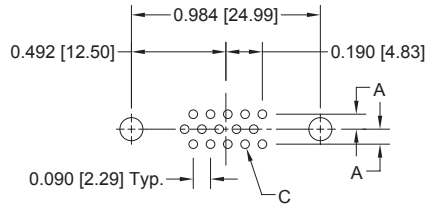

**ODD15 FEMALE**

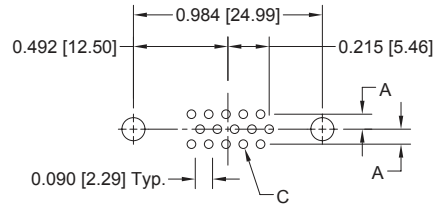

**ODD26 MALE**

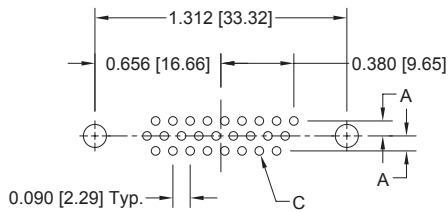

**ODD26 FEMALE**

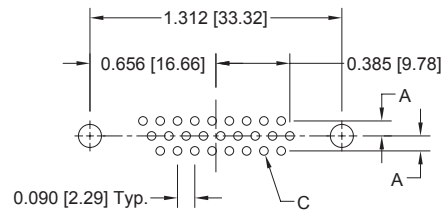

**ODD44 MALE**

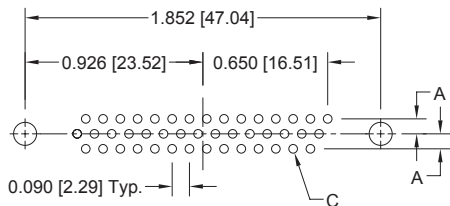

**ODD44 FEMALE**

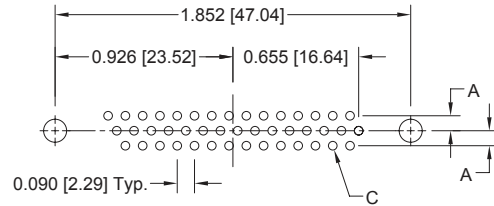

**ODD62 MALE**

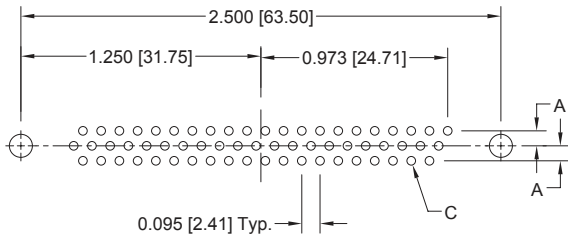

**ODD62 FEMALE**

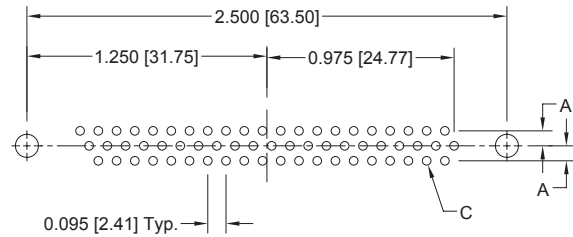

**ODD78 MALE**

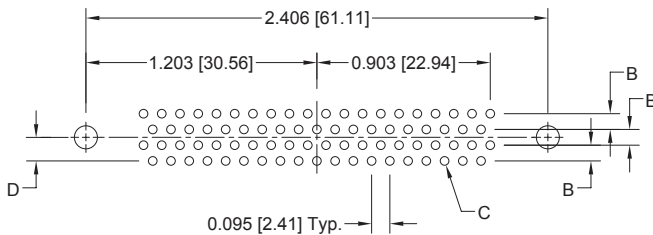

**ODD78 FEMALE**

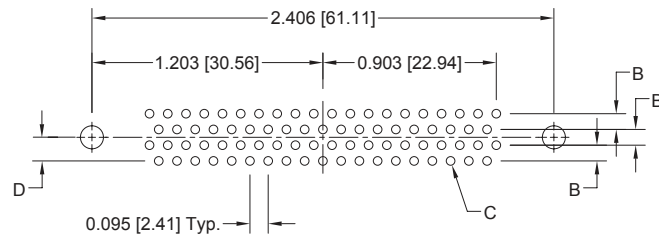

**ODD104 MALE**

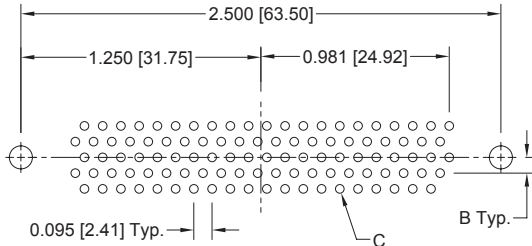

**ODD104 FEMALE**

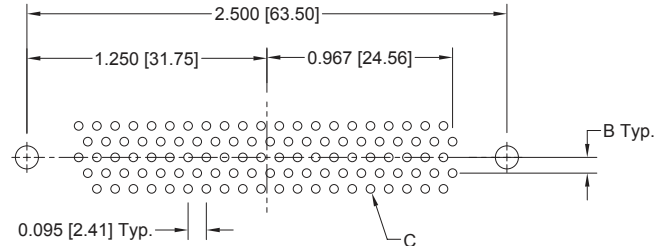

**SUGGESTED PRINTED BOARD HOLE SIZES:**

Suggest 0.123 ±0.003 [3.12 ±0.08] Ø hole for mounting connector with push-on fasteners.

CODE NUMBER	A	B	ØC	D
4	0.100 [2.54]	0.100 [2.54]	0.045 [1.14]	0.100 [2.54]
3, 32, 5	0.078 [1.98]	0.082 [2.08]	0.035 [0.89]	0.123 [3.12]

ODD SERIES



## ORDERING INFORMATION - CODE NUMBERING SYSTEM

Specify Complete Connector By Selecting An Option From Step 1 Through 8

STEP	1	2	3	4	5	6	7	8	9	10
<b>EXAMPLE</b>	ODD	62	F	5	R7	N	T6	S	/AA	-14
<b>STEP 1 - BASIC SERIES</b> ODD series										<b>STEP 10 - SPECIAL OPTIONS</b> -14 - 0.000030 [0.76µ] gold over nickel. -15 - 0.000050 [1.27µ] gold over nickel. <b>CONTACT TECHNICAL SALES FOR SPECIAL OPTIONS</b>
<b>STEP 2 - CONNECTOR VARIANTS</b> 15, 26, 44, 62, 78, 104										
<b>STEP 3 - CONNECTOR GENDER</b> M - Male F - Female - Professional Level open entry contacts S - Female - Industrial Level PosiBand closed entry contacts										
<b>STEP 4 - CONTACT TERMINATION TYPE</b> 0 - Contacts ordered separately, see pages 45-47. 1 - Crimp, 22 AWG-30 AWG [0.3mm <sup>2</sup> -0.05mm <sup>2</sup> ]. 2 - Removable, solder cup, 22 AWG-30 AWG [0.3mm <sup>2</sup> -0.05mm <sup>2</sup> ]. 21 - Fixed, solder cup, 22 AWG-30 AWG [0.3mm <sup>2</sup> -0.05mm <sup>2</sup> ]. 3 - Solder, Straight Printed Board Mount with 0.150 [3.81] Tail Length. 32 - Solder, Straight Printed Board Mount with 0.300 [7.62] Tail Length. 4 - Solder, Right Angle (90°) Printed Board Mount with 0.314 [7.98] Contact Extension. 5 - Solder, Right Angle (90°) Printed Board Mount with 0.450 [11.43] Contact Extension.										
<b>*1 STEP 5 - MOUNTING STYLE</b> 0 - Mounting Hole, 0.120 [3.05] Ø. 02 - Mounting Hole, 0.154 [3.91] Ø. B3 - Bracket, Mounting, Right Angle (90°) Metal with Cross Bar. B8 - Bracket, Mounting, Right Angle (90°) Plastic with Cross Bar. F - Float Mounts, Universal. P - Threaded Post, Brass, 0.225 [5.71] Length. P2 - Threaded Post, Nylon, 0.225 [5.71] Length. R2 - Bracket, Mounting, Right Angle (90°) Metal, Swaged to Connector with 4-40 Thread Fixed Female Jackscrews with Cross Bar. R6 - Bracket, Mounting, Right Angle (90°) Metal, Swaged to Connector with 0.120 [3.05] Ø Mounting Hole with Cross Bar. R7 - Bracket, Mounting, Right Angle (90°) Metal, Swaged to Connector with 4-40 Threads with Cross Bar. R8 - Bracket, Mounting, Right Angle (90°) Metal, Swaged to Connector with 4-40 Locknut with Cross Bar. S - Swaged Spacer, 4-40 Threads, 0.225 [5.71] Length. S2 - Swaged Spacer, 4-40 Threads, 0.125 [3.18] Length. S5 - Swaged Locknut, 4-40 Threads. S6 - Swaged Spacer with Push-on Fasteners, 4-40 Threads, 0.225 [5.71] Length. S7 - Swaged Spacer with Push-on Fastener for use with Ferrite Inductor, 4-40 Threads, 0.375 [9.53] Length.										
<b>*1 STEP 7 - LOCKING AND POLARIZING SYSTEMS</b> 0 - None. *3 V3 - Lock Tab, connector front panel mounted. *3 V5 - Lock Tab, connector rear panel mounted. *3 VL - Lock Lever, used with Hoods Only. T - Fixed Female Jackscrews. T2 - Fixed Female Jackscrews. T6 - Fixed Male and Female Polarized Jackscrews. E - Rotating Male Jackscrews. E2 - Rotating Male Screw Locks. E3 - Rotating Male with internal hex for 3/32 hex drives E6 - Rotating Male and Female Polarized Jackscrews.										
<b>*1 STEP 6 - HOODS</b> 0 - None. J - Hood, Top Opening, Plastic. L - Hood, Side Opening, Plastic. Y - Hood, Top Opening, Plastic with Rotating Male Jackscrews. Available in size 78 and 104 only. Y6 - Hood, Top Opening, Plastic with Rotating Male and Female Polarized Jackscrews. Available in size 78 and 104 only. Z - Hood, Top or Side Opening, Robust Extended Height, Composite and Plastic with Rotating Male Jackscrews. Available in size 15, 26, 44, 62 and 78 only. H - Hood, Top Opening, Metal. Available in size 26, 44, 62, and 78 only. G - Hood, EMI/RFI, Die Cast Zinc. AN - Lightweight Aluminum Hood, nickel finish. AC - Lightweight Aluminum Hood, no finish. W - Hood, Top or Side Opening, Plastic. Available in size 15, 26, and 44 only. N - Push-on Fastener, for Right Angle (90°) Mounting. *2 F - Ferrite Inductor. *2 Q - Ferrite Inductor with Push-on Fastener, for Right Angle (90°) Mounting Brackets.										
<b>STEP 8 - Shell Options</b> 0 - Zinc plated with chromate seal. *S - Stainless steel, passivated. X - Tin plated. Z - Tin plated and dimpled (male connectors only).										
<b>STEP 9 - ENVIRONMENTAL COMPLIANCE OPTIONS</b> /AA - RoHS Compliant <b>NOTE:</b> If compliance to environmental legislation is not required, this step will not be used. Example: ODD62F5R7NT6S										

\*1 For additional information on accessories listed in steps 5, 6 and 7, see Accessory Catalog.

\*2 Ferrite inductor is available on contact types 32 and 5 only. For more information on ferrite inductors, see page 7.

\*3 VL, V3 and V5 locking systems are not available for connector variants 62, 78 and 104. Jackscrews are highly recommended to minimize damage to contacts on variants with high mating forces.

\*4 For stainless steel dimpled male versions contact Technical Sales.

For information regarding **CRIMP TOOLS & CRIMPING TOOL TECHNIQUES**, see page 78.



Positronic  
connectpositronic.com

# MILITARY QUALITY FIXED AND REMOVABLE CONTACTS HIGH DENSITY D-SUBMINIATURE

D-Sub

Size 22 Signal and  
Thermocouple Contacts,  
Removable Crimp and  
Printed Board Mount

PosiBand® Closed Entry

MIL-DTL-24308 and SAE AS39029

UL Recognized  
File #E49351

CSA Recognized  
File #LR54219

Telecommunication  
UL File #E140980



Densi-D series connectors are military quality, high density connectors designed for use in sheltered, mildly corrosive environments having a wide range of temperature, pressure and humidity changes. Applicable connectors are qualified to MIL-DTL-24308 and SAE AS39029 (see page 82 for more information).

Densi-D series connectors utilize precision machined contacts with closed barrel crimp terminations, solder cup termi-

nations, straight and right angle (90°) printed board mount. All female contacts utilize Positronic's unique PosiBand closed entry design, see page 1 for details.

Six standard contact variants are offered in arrangements of 15, 26, 44, 62, 78 and 104 contacts. Densi-D series connectors are mateable and compatible with other high density D-subminiature connectors conforming to MIL-DTL-24308.

A wide variety of unique accessories are available.

## DENSI-D SERIES TECHNICAL CHARACTERISTICS

### MATERIALS AND FINISHES:

<b>Insulators:</b>	Glass filled polyester per ASTM D5927, UL 94V-0, blue color.
<b>Contacts:</b>	Precision machined copper alloy.
<b>Contact Plating:</b>	Military performance - 0.000050 inch [1.27 µ] gold over nickel plate. Industrial performance - gold flash over nickel plate. Other finishes available upon request.
<b>Shells:</b>	Steel with tin plate; zinc plate with chromate seal, stainless steel passivated. Other materials and finishes available upon request.
<b>Mounting Spacers:</b>	Nylon; copper alloy or steel with zinc plate and chromate seal or tin plate; phosphor bronze with tin plate; stainless steel, passivated.
<b>Push-On Fastener:</b>	Phosphor bronze or beryllium copper with tin plate.
<b>Vibration Lock Systems:</b>	Slide lock and lock tabs, steel with nickel plate.
<b>Jackscrew Systems:</b>	Brass or steel with zinc plate and chromate seal or clear zinc plate or tin plate; stainless steel, passivated.
<b>Hoods:</b>	Composite and plastic, UL 94V-0; brass or steel with zinc plate and chromate seal. Aluminum; aluminum with electroless nickel plate. For aluminum hoods, zinc content is 1% maximum. Die cast zinc.

Low magnetic versions are available, contact Technical Sales.

### MECHANICAL CHARACTERISTICS:

<b>Removable Contacts:</b>	Insert contact to rear face of insulator and release from rear face of insulator. Size 22 contacts, male - 0.030 inch [0.76mm] mating diameter. Female contacts - PosiBand closed entry design, see page 1 for details.
<b>Contact Retention In Insulator:</b>	9 lbs. [40 N].
<b>Contact Terminations:</b>	Closed barrel crimp, wire sizes 22 AWG

[0.3mm<sup>2</sup>] through 30 AWG [0.05mm<sup>2</sup>] per IEC 352-2.

Right Angle (90°) Printed Board Mount contact terminations.

<b>Shells:</b>	Male shells may be dimpled for EMI/ESD ground paths.
<b>Polarization:</b>	Trapezoidally shaped shells and polarized jackscrews.
<b>Mounting To Angle Brackets:</b>	Jackscrews and riveted fasteners with 0.120 inch [3.05mm] clearance hole, and threaded riveted fasteners with 4-40 threads and polyester lock inserts.
<b>Mounting To Printed Board:</b>	Rapid installation push-on fasteners and mounting posts.
<b>Locking Systems:</b>	Jackscrews and vibration locking systems.
<b>Mechanical Operations:</b>	1000 operations minimum per IEC 60512-5.

### ELECTRICAL CHARACTERISTICS:

#### Contact Current Rating, Tested per UL 1977:

12 amperes, 2 contacts energized.
10 amperes, 6 contacts energized.
7.5 amperes, 26 contacts energized.
6.5 amperes, 62 contacts energized.
5.0 amperes, 104 contacts energized.

See temperature rise curves on page 2 for details.

<b>Initial Contact Resistance:</b>	0.005 ohms maximum.
<b>Proof Voltage:</b>	1000 V r.m.s.
<b>Insulation Resistance:</b>	5 G ohms.
<b>Clearance and Creepage Distance [minimum]:</b>	0.042 inch [1.06mm].
<b>Working Voltage:</b>	300 V r.m.s.

### CLIMATIC CHARACTERISTICS:

<b>Temperature Range:</b>	-55°C to +125°C.
<b>Damp Heat, Steady State:</b>	21 days.

### THERMOCOUPLE CONTACTS:

Size 22 crimp contacts are available, see page 56 for details.

Printed circuit board mount contacts are available, please Consult Accessories D-subminiature catalog for details.



CONTACT VARIANTS

FACE VIEW OF MALE OR REAR VIEW OF FEMALE

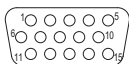

DD 15

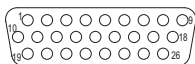

DD 26

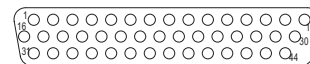

DD 44

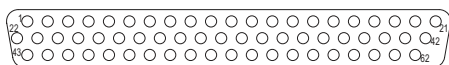

DD 62

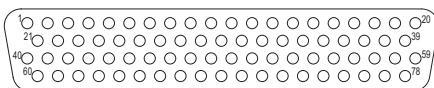

DD 78

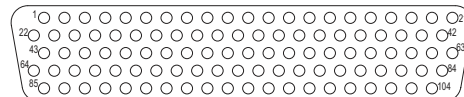

DD 104

STANDARD SHELL ASSEMBLY

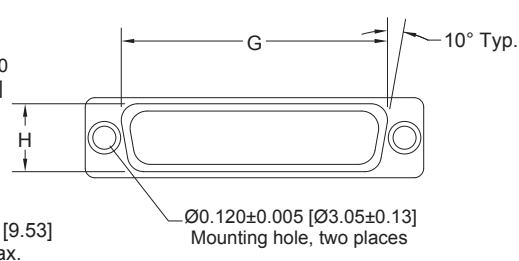
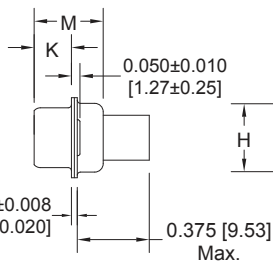
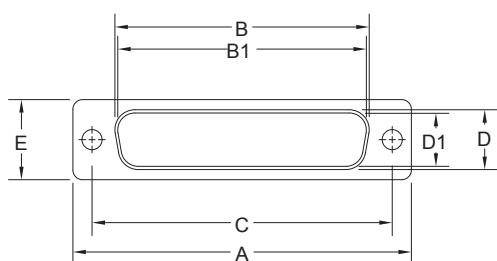

OPTIONAL SHELL ASSEMBLY (0, 02)

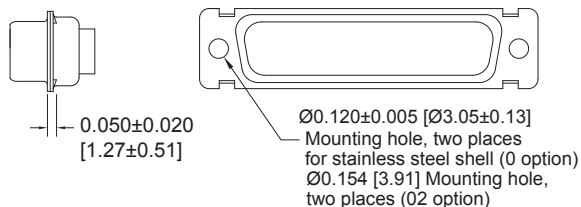

OPTIONAL SHELL ASSEMBLY WITH UNIVERSAL FLOAT MOUNTS (F)

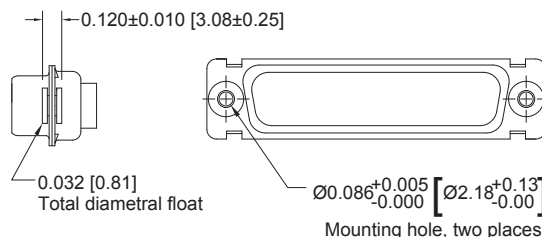

CONNECTOR VARIANT SIZES	A ±0.015 [0.38]	B ±0.005 [0.13]	B1 ±0.005 [0.13]	C ±0.005 [0.13]	D ±0.005 [0.13]	D1 ±0.005 [0.13]	E ±0.015 [0.38]	G ±0.010 [0.25]	H ±0.010 [0.25]	K ±0.005 [0.13]	M ±0.010 [0.25]
DD 15 M	1.213 [30.81]		0.666 [16.92]	0.984 [24.99]		0.329 [8.36]	0.494 [12.55]	0.759 [19.28]	0.422 [10.72]	0.233 [5.92]	0.422 [10.72]
DD 15 S	1.213 [30.81]	0.643 [16.33]		0.984 [24.99]	0.311 [7.90]		0.494 [12.55]	0.759 [19.28]	0.422 [10.72]	0.243 [6.17]	0.429 [10.90]
DD 26 M	1.541 [39.14]		0.994 [25.25]	1.312 [33.32]		0.329 [8.36]	0.494 [12.55]	1.083 [27.51]	0.422 [10.72]	0.233 [5.92]	0.422 [10.72]
DD 26 S	1.541 [39.14]	0.971 [24.66]		1.312 [33.32]	0.311 [7.90]		0.494 [12.55]	1.083 [27.51]	0.422 [10.72]	0.243 [6.17]	0.429 [10.90]
DD 44 M	2.088 [53.04]		1.534 [38.96]	1.852 [47.04]		0.329 [8.36]	0.494 [12.55]	1.625 [41.28]	0.422 [10.72]	0.230 [5.84]	0.426 [10.82]
DD 44 S	2.088 [53.04]	1.511 [38.38]		1.852 [47.04]	0.311 [7.90]		0.494 [12.55]	1.625 [41.28]	0.422 [10.72]	0.243 [6.17]	0.429 [10.90]
DD 62 M	2.729 [69.32]		2.182 [55.42]	2.500 [63.50]		0.329 [8.36]	0.494 [12.55]	2.272 [57.71]	0.422 [10.72]	0.230 [5.84]	0.426 [10.82]
DD 62 S	2.729 [69.32]	2.159 [54.84]		2.500 [63.50]	0.311 [7.90]		0.494 [12.55]	2.272 [57.71]	0.422 [10.72]	0.243 [6.17]	0.429 [10.90]
DD 78 M	2.635 [66.93]		2.079 [52.81]	2.406 [61.11]		0.441 [11.20]	0.605 [15.37]	2.178 [55.32]	0.534 [13.56]	0.230 [5.84]	0.426 [10.82]
DD 78 S	2.635 [66.93]	2.064 [52.43]		2.406 [61.11]	0.423 [10.74]		0.605 [15.37]	2.178 [55.32]	0.534 [13.56]	0.243 [6.17]	0.429 [10.90]
DD 104 M	2.729 [69.32]		2.212 [56.18]	2.500 [63.50]		0.503 [12.78]	0.668 [16.97]	2.302 [58.47]	0.596 [15.14]	0.230 [5.84]	0.426 [10.82]
DD 104 S	2.729 [69.32]	2.189 [55.60]		2.500 [63.50]	0.485 [12.32]		0.668 [16.97]	2.302 [58.47]	0.596 [15.14]	0.243 [6.17]	0.429 [10.90]



Positronic  
connectpositronic.com

# MILITARY QUALITY FIXED AND REMOVABLE CONTACTS HIGH DENSITY D-SUBMINIATURE

D-Sub

## REMOVABLE CRIMP CONTACT

CODE 1

CONTACTS MAY BE SUPPLIED WITH CONNECTOR OR ORDERED SEPARATELY.

QUALIFIED TO SAE AS39029

### \*MILITARY SPECIFICATION CONTACTS

**STANDARD FINISH:**  
per SAE AS39029 specifications

**COLOR CODE:**

**MALE CONTACT:**  
ORANGE/BLUE/BLACK

**FEMALE CONTACT:**  
ORANGE/GREEN/YELLOW

Note: Connectors can be kitted with all applicable crimp/solder contacts, contact Technical Sales for connector part number.

### FEMALE CONTACT "CLOSED ENTRY" DESIGN

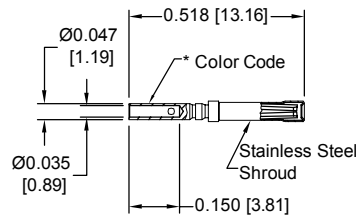

### MALE CONTACT

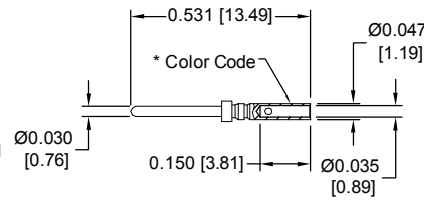

FEMALE PART NUMBER	WIRE SIZE AWG/[mm <sup>2</sup> ]
*M39029/57-354	22 / 24 / 26 / 28 [0.3/0.25/0.12/0.08]
Positronic is qualified to supply the legacy design, as well as, the PosiBand design. If the requirement is for the PosiBand design exclusively, notify sales at time of quotation for order placement when requesting M39029 contacts.	

MALE PART NUMBER	WIRE SIZE AWG/[mm <sup>2</sup> ]
*M39029/58-360	22 / 24 / 26 / 28 [0.3/0.25/0.12/0.08]

## REMOVABLE CRIMP CONTACT

CODE 1

CONTACTS MAY BE SUPPLIED WITH CONNECTOR OR ORDERED SEPARATELY.



Authentic POSITRONIC

PosiBand®

These contacts utilize authentic Positronic PosiBand® technology.  
Protected by U.S. Patent 7,115,002

Note: Connectors can be kitted with all applicable crimp/solder contacts, contact Technical Sales for connector part number.

### FEMALE CONTACT "CLOSED ENTRY" DESIGN

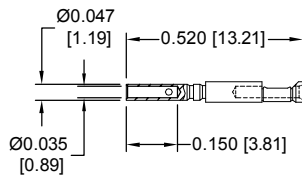

### MALE CONTACT

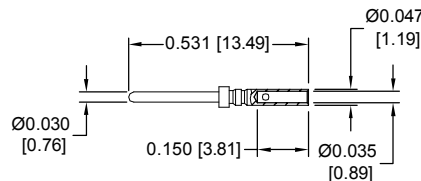

FEMALE PART NUMBER	WIRE SIZE AWG/[mm <sup>2</sup> ]
FC8022D2	22 / 24 / 26 / 28 / 30 [0.3/0.25/0.12/0.08/0.05]

MALE PART NUMBER	WIRE SIZE AWG/[mm <sup>2</sup> ]
MC8022D	22 / 24 / 26 / 28 / 30 [0.3/0.25/0.12/0.08/0.05]

**PLATING:**

**STANDARD FINISH:** Gold flash over nickel plate.

**OPTIONAL FINISHES:** 0.000030 [0.76] gold over nickel by adding "-14" suffix onto part number. Example: FC8022D2-14

0.000050 inch [1.27] gold over nickel by adding "-15" suffix onto part number. Example: MC8022D-15

For information regarding **CRIMP TOOLS & CRIMPING TOOL TECHNIQUES**, see page 78.



Authentic POSITRONIC  
PosiBand®

These contacts utilize authentic Positronic PosiBand® technology.  
Protected by U.S. Patent 7,115,002

REMOVABLE CRIMP CONTACT  
20 AWG CONTACTS  
20 AWG [0.5 mm<sup>2</sup>]

The crimp area of this contact is not protected when fully seated in the connector molding. These contacts require shrink tubing after installation. Wire cannot be removed from molding after insertion. Not suitable for fully loaded connector.

CONTACTS MAY BE SUPPLIED WITH CONNECTOR OR ORDERED SEPARATELY.

Note: FC8020D2 and MC8020D contacts can be used in the ODD series.

Note: Connectors can be kitted with all applicable crimp/solder contacts, contact Technical Sales for connector part number.

FEMALE CONTACT  
"CLOSED ENTRY" DESIGN

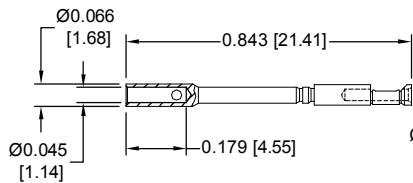

MALE CONTACT

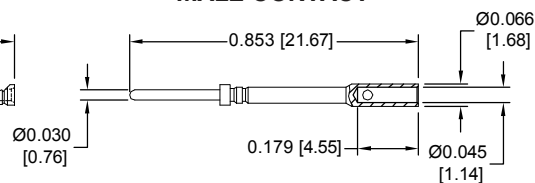

Crimp area extends above connector molding.

FEMALE PART NUMBER	WIRE SIZE AWG/[mm <sup>2</sup> ]
FC8020D2	20 [0.5] max

MALE PART NUMBER	WIRE SIZE AWG/[mm <sup>2</sup> ]
MC8020D	20 [0.5] max

PLATING:

STANDARD FINISH: Gold flash over nickel plate.

OPTIONAL FINISHES: 0.000030 [0.76] gold over nickel by adding "-14" suffix onto part number. Example: FC8020D2-14  
0.000050 inch [1.27] gold over nickel by adding "-15" suffix onto part number. Example: MC8020D-15

REMOVABLE THERMOCOUPLE CRIMP CONTACT

CONTACTS MAY BE SUPPLIED WITH CONNECTOR OR ORDERED SEPARATELY.

Note: Connectors can be kitted with all applicable crimp/solder contacts, contact Technical Sales for connector part number.



Authentic POSITRONIC  
PosiBand®

These contacts utilize authentic Positronic PosiBand® technology.  
Protected by U.S. Patent 7,115,002

FEMALE CONTACT  
"CLOSED ENTRY" DESIGN

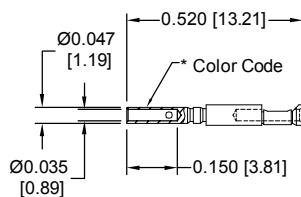

MALE CONTACT

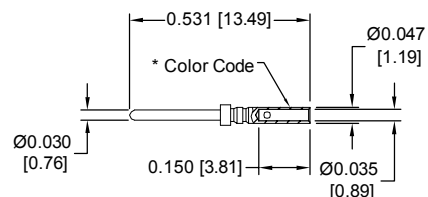

TYPE	MATERIAL	FEMALE PART NUMBER	MALE PART NUMBER	COLOR CODE*	WIRE SIZE AWG [mm <sup>2</sup> ]
K	CHROMEL (+)	FC8022D2CH	MC8022DCH	WHITE	22 / 24 / 26 [ 0.3 / 0.25 / 0.12]
	ALUMEL (-)	FC8022D2AL	MC8022DAL	GREEN	22 / 24 / 26 [ 0.3 / 0.25 / 0.12]
T	COPPER (+)	FC8022D2CU	MC8022DCU	RED	22 / 24 / 26 [ 0.3 / 0.25 / 0.12]
	CONSTANTAN (-)	FC8022D2CO	MC8022DCO	YELLOW	22 / 24 / 26 [ 0.3 / 0.25 / 0.12]
E	CHROMEL (+)	FC8022D2CH	MC8022DCH	WHITE	22 / 24 / 26 [ 0.3 / 0.25 / 0.12]
	CONSTANTAN (-)	FC8022D2CO	MC8022DCO	YELLOW	22 / 24 / 26 [ 0.3 / 0.25 / 0.12]

For more information on the availability of Type J thermocouple contacts, please contact Technical Sales.

For more information about thermocouple contacts with printed circuit board solder termination, please contact Technical Sales.

Chromel® and Alumel® are registered trademarks of Hoskins Manufacturing Company

For information regarding CRIMP TOOLS & CRIMPING TOOL TECHNIQUES, see page 78.



Positronic  
connectpositronic.com

# MILITARY QUALITY FIXED AND REMOVABLE CONTACTS HIGH DENSITY D-SUBMINIATURE

D-Sub

## REMOVABLE SOLDER CUP CONTACTS CODE 2

CONTACTS MAY BE SUPPLIED WITH CONNECTOR OR ORDERED SEPARATELY.

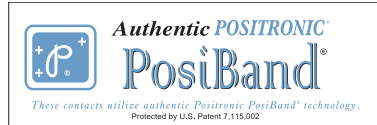

Note: Connectors can be kitted with all applicable crimp/solder contacts, contact Technical Sales for connector part number.

### FEMALE CONTACT "CLOSED ENTRY" DESIGN

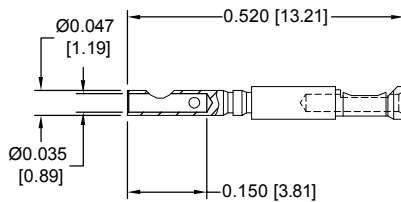

FEMALE PART NUMBER	WIRE SIZE AWG/[mm <sup>2</sup> ]
FS8022D2	22 [0.3] max

### MALE CONTACT

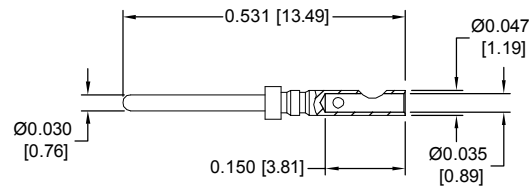

MALE PART NUMBER	WIRE SIZE AWG/[mm <sup>2</sup> ]
MS8022D	22 [0.3]max

#### PLATING:

**STANDARD FINISH:** Gold flash over nickel plate.

**OPTIONAL FINISHES:** 0.000030 [0.76] gold over nickel by adding "-14" suffix onto part number. Example: FS8022D2-14  
0.000050 inch [1.27] gold over nickel by adding "-15" suffix onto part number. Example: MS8022D-15

For information regarding *INSERTION & REMOVAL TOOLS*, see page 78.

## STRAIGHT PRINTED BOARD MOUNT TERMINATION

CODE 3, 32 AND 33

CODE NUMBER	L
3	0.150 [3.81]
32	0.300 [7.62]
33	0.500 [12.70]

For straight printed board mount contacts specify code no. in step 4 of ordering information.

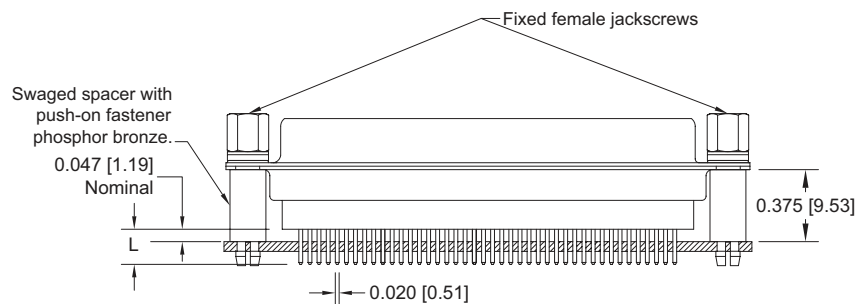

Typical Part Number: DD62S3S60T2X

DD SERIES





**RIGHT ANGLE (90°) PRINTED BOARD MOUNT TERMINATION  
CODE 4, 0.450 [11.43] CONTACT EXTENSION**

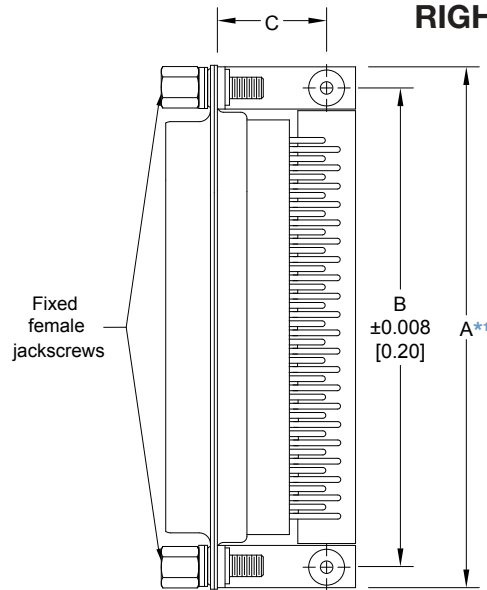

DD**4*** 0.450 [11.43] CONTACT EXTENSION				
PART NUMBER	A*1	B	C	D
DD15*4***	1.204 [30.58]	0.984 [24.99]	0.528 [13.41]	0.450 [11.43]
DD26*4***	1.532 [38.91]	1.312 [33.32]	0.528 [13.41]	0.450 [11.43]
DD44*4***	2.072 [52.63]	1.852 [47.04]	0.528 [13.41]	0.450 [11.43]
DD62*4***	2.720 [69.09]	2.500 [63.50]	0.528 [13.41]	0.450 [11.43]
DD78*4***	2.626 [66.70]	2.406 [61.11]	0.573 [14.55]	0.450 [11.43]

**NOTE:**

\*1 "A" dimension applies for metal angle brackets only. Consult Accessories D-subminiature catalog for "A" dimension when plastic brackets are used.

Specify code 4 in step 4 of ordering information

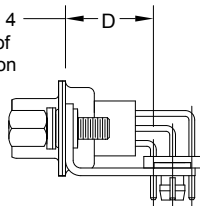

Typical Part Number:  
DD44M4R7NT2X

0.078 [1.98] Typ.  
0.078 [1.98] Typ.

Numbering shown is rear view of male and face view of female.

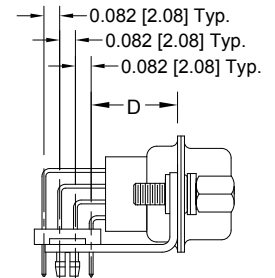
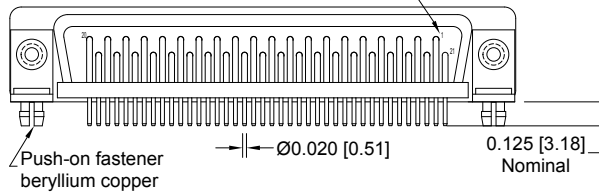

Typical Part Number:  
DD78M4R7NT2X

**RIGHT ANGLE (90°) PRINTED BOARD MOUNT TERMINATION, SIZE 104  
CODE 4, 0.450 [11.43] CONTACT EXTENSION**

**NOTE:**

\*1 Dimension applies for metal angle brackets only. Consult Accessories D-subminiature catalog for dimension when plastic brackets are used.

Typical Part Number: DD104M4R7NT20

Specify code 4 in step 4 of ordering information

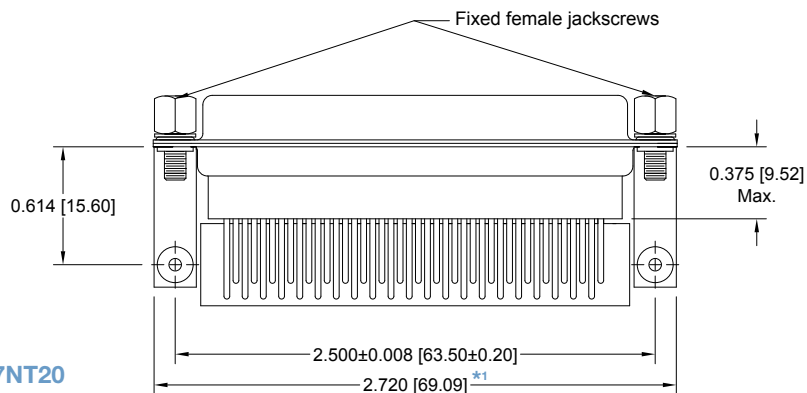
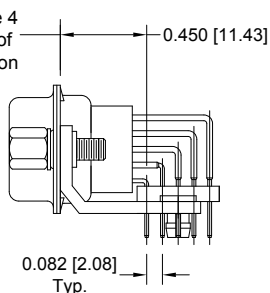

Numbering shown is rear view of male and face view of female

Push-on fastener beryllium copper

0.125 [3.17] Nominal  
Ø0.020 [0.51]

DIMENSIONS ARE IN INCHES [MILLIMETERS].  
ALL DIMENSIONS ARE SUBJECT TO CHANGE.



**RIGHT ANGLE (90°) AND STRAIGHT PRINTED BOARD CONTACT HOLE PATTERN**  
MOUNT CONNECTOR WITH MATING FACE POSITIONED TO FOLLOW DIRECTION OF ARROWS.

**DD15 MALE**

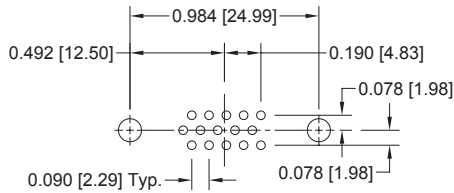

**DD15 FEMALE**

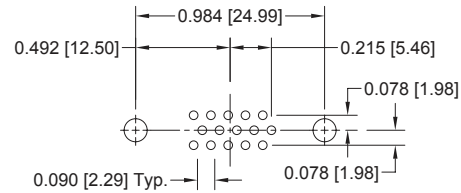

**DD 26 MALE**

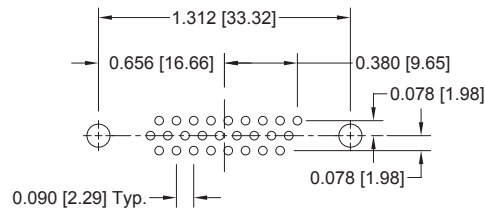

**DD 26 FEMALE**

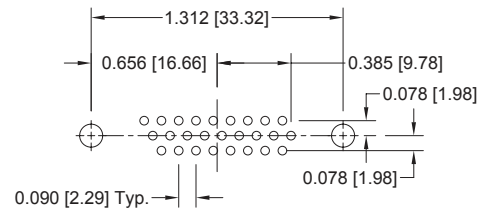

**DD44 MALE**

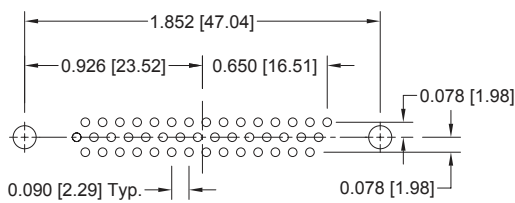

**DD44 FEMALE**

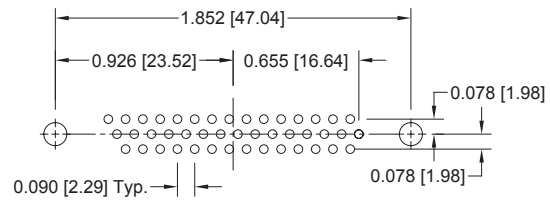

**DD62 MALE**

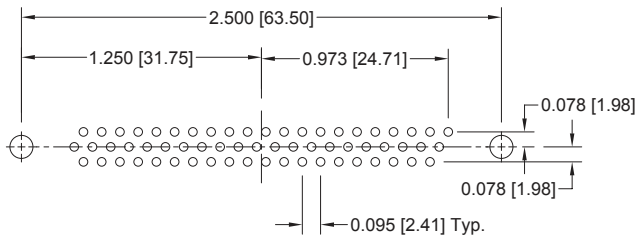

**DD62 FEMALE**

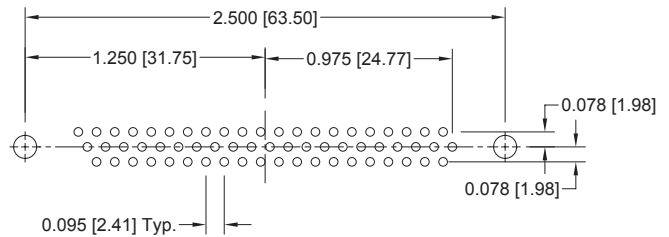

**DD78 MALE**

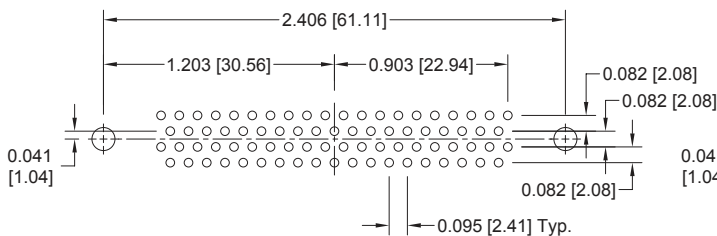

**DD78 FEMALE**

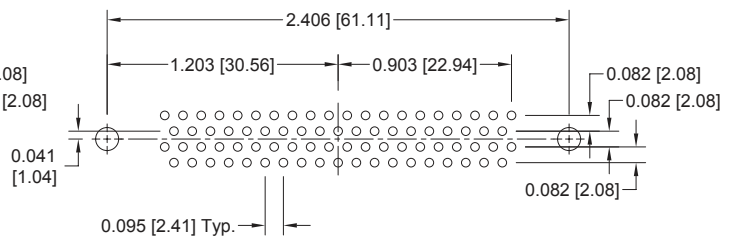

**DD104 MALE**

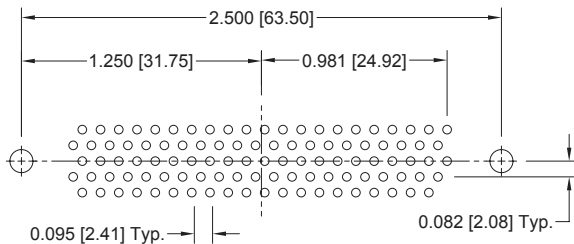

**DD104 FEMALE**

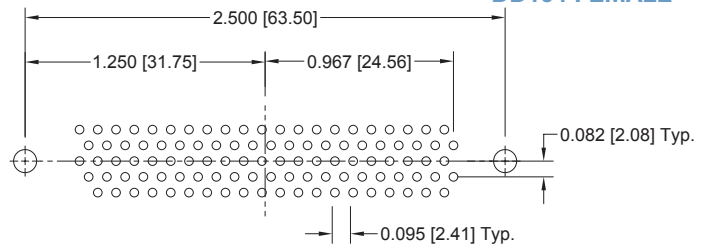

**SUGGESTED PRINTED BOARD HOLE SIZES:**

Suggest 0.035 [0.89] Ø hole for contact termination positions.

Suggest 0.123 ±0.003 [3.12 ±0.08] Ø hole for mounting connector with push-on fasteners.



**ORDERING INFORMATION - CODE NUMBERING SYSTEM**

Specify Complete Connector By Selecting An Option From Step 1 Through 8

STEP	1	2	3	4	5	6	7	8	9	10
<b>EXAMPLE</b>	DD	62	S	4	R7	N	T6	S	/AA	-50
<b>STEP 1 - BASIC SERIES</b> DD series										<b>STEP 10 - SPECIAL OPTIONS</b> -14 - 0.000030 [0.76µ] gold over nickel. -15 - 0.000050 [1.27µ] gold over nickel. -50 - 0.000050 [1.27µ] gold over copper. <b>CONTACT TECHNICAL SALES FOR ORDERING DETAILS OF THE FOLLOWING:</b> Other Special Requirements. Straight and Right Angle (90°) Thermocouple printed circuit board mount contacts
<b>STEP 2 - CONNECTOR VARIANTS</b> 15, 26, 44, 62, 78, 104										
<b>STEP 3 - CONNECTOR GENDER</b> M - Male S - Female - PosiBand closed entry contacts										
<b>STEP 4 - CONTACT TERMINATION TYPE</b> 0 - Contacts ordered separately, see pages 55-57. 1 - Crimp, 22 AWG-30 AWG [0.3mm <sup>2</sup> -0.05mm <sup>2</sup> ]. 2 - Removable, Solder cup, 22 AWG-30 AWG [0.3mm <sup>2</sup> -0.05mm <sup>2</sup> ]. 3 - Solder, Straight Printed Board Mount with 0.150 [3.81] Tail Length. 32 - Solder, Straight Printed Board Mount with 0.300 [7.62] Tail Length. 33 - Solder, Straight Printed Board Mount with 0.500 [12.70] Tail Length. 4 - Solder, Right Angle (90°) Printed Board Mount with 0.450 [11.43] Contact Extension.										
<b>*1 STEP 5 - MOUNTING STYLE</b> 0 - Mounting Hole, 0.120 [3.05] Ø. 02 - Mounting Hole, 0.154 [3.91] Ø. B3 - Bracket, Mounting, Right Angle (90°) Metal with Cross Bar. B8 - Bracket, Mounting, Right Angle (90°) Plastic with Cross Bar. F - Float Mounts, Universal. P - Threaded Post, Brass, 0.375 [9.53] Length. P2 - Threaded Post, Nylon, 0.375 [9.53] Length. R2 - Bracket, Mounting, Right Angle (90°) Metal, Swaged to Connector with 4-40 Thread Fixed Female Jackscrews with Cross Bar. R6 - Bracket, Mounting, Right Angle (90°) Metal, Swaged to Connector with 0.120 [3.05] Ø Mounting Hole with Cross Bar. R7 - Bracket, Mounting, Right Angle (90°) Metal, Swaged to Connector with 4-40 Threads with Cross Bar. R8 - Bracket, Mounting, Right Angle (90°) Metal, Swaged to Connector with 4-40 Locknut with Cross Bar. S - Swaged Spacer, 4-40 Threads, 0.375 [9.53] Length. S2 - Swaged Spacer, 4-40 Threads, 0.125 [3.18] Length. S5 - Swaged Locknut, 4-40 Threads. S6 - Swaged Spacer with Push-on Fasteners, 4-40 Threads, 0.375 [9.53] Length. S7 - Swaged Spacer with Push-on Fastener for use with Ferrite Inductor, 4-40 Threads, 0.515 [13.08] Length.										
<b>STEP 8 - SHELL OPTIONS</b> 0 - Zinc plated with chromate seal. *S - Stainless steel, passivated. X - Tin plated. Z - Tin plated and dimpled (male connectors only). C - Cadmium with chromate seal.										
<b>*1 STEP 7 - LOCKING AND POLARIZING SYSTEMS</b> 0 - None. *3 V3 - Lock Tab, connector front panel mounted. *3 V5 - Lock Tab, connector rear panel mounted. *3 VL - Lock Lever, used with Hoods only. T - Fixed Female Jackscrews. T2 - Fixed Female Jackscrews. T6 - Fixed Male and Female Polarized Jackscrews. E - Rotating Male Jackscrews. E2 - Rotating Male Screw Locks. E3 - Rotating Male with internal hex for 3/32 hex drives E6 - Rotating Male and Female Polarized Jackscrews.										
<b>*1 STEP 6 - HOODS AND PUSH-ON FASTENERS</b> 0 - None. J - Hood, Top Opening, Plastic. L - Hood, Side Opening, Plastic. Y - Hood, Top Opening, Plastic with Rotating Male Jackscrews. Available in size 78 and 104 only. Y6 - Hood, Top Opening, Plastic with Rotating Male and Female Polarized Jackscrews. Available in size 78 and 104 only. Z - Hood, Top or Side Opening, Robust and Extended Height, Composite and Plastic with Rotating Male Jackscrews. Available in size 15, 26, 44, 62, and 78 only. H - Hood, Top Opening, Metal. Available in size 26, 44, 62, and 78 only. G - Hood, EMI/RFI, Die Cast Zinc. AN - Lightweight Aluminum Hood, nickel finish. AC - Lightweight Aluminum Hood, no finish. W - Hood, Top or Side Opening, Plastic. Available in size 15, 26, and 44 only. N - Push-on Fastener, for Right Angle (90°) Mounting Brackets. *2F - Ferrite Inductor										
<b>STEP 9 - ENVIRONMENTAL COMPLIANCE OPTIONS</b> /AA - RoHS Compliant <b>NOTE:</b> If compliance to environmental legislation is not required, this step will not be used. Example: DD62S4R7NT6S										

\*1 For additional information on accessories listed in steps 5, 6 and 7, see Accessory Catalog.

\*2 Ferrite inductor is available on contact types 32 and 33 only. For more information on ferrite inductors, see page 7.

\*3 VL, V3 and V5 locking systems are not available for connector variants 62, 78 and 104. Jackscrews are highly recommended to minimize damage to contacts on variants with high mating forces.

\*4 For stainless steel dimpled male versions contact Technical Sales.

For information regarding **CRIMP TOOLS & CRIMPING TOOL TECHNIQUES**, see page 78.



Positronic  
connectpositronic.com

PROFESSIONAL / INDUSTRIAL / MILITARY QUALITY  
COMPLIANT PRESS-FIT  
STANDARD DENSITY D-SUBMINIATURE

D-Sub

Size 20 Contacts, Fixed  
Machined Compliant Press-Fit  
Three Performance Levels For  
Best Cost / Performance Ratio

Professional Quality  
IEC 60807-2 & IEC 60352-5

UL Recognized  
File #E49351

Telecommunication  
UL File #E140980



PCD series connectors are quality connectors with compliant terminations. The low press-in force required to install the contacts into the board eliminates printed board pressure-warp and twisting stresses which can result in expensive repair or replacement of printed boards and back panels.

Five standard connector variants are offered in arrangement of 9, 15, 25, 37, and 50 contacts. PCD connectors are mateable and compatible with all D-subminiature connectors conforming to IEC 60807-2, IEC 60807-3, and dimensional requirements of MIL-DTL-24308.

## PCD COMPLIANT PRESS-D CONNECTOR TECHNICAL CHARACTERISTICS

### MATERIALS AND FINISHES:

<b>Insulator:</b>	Glass filled polyester per ASTM D5927, UL 94V-0, blue color.
<b>Contacts:</b>	Precision machined copper alloy.
<b>Contact Plating:</b>	Professional performance - Gold flash over nickel plate. Other finishes available upon request.
<b>Shells:</b>	Steel with tin plate; zinc plate with chromate seal, stainless steel passivated. Other materials and finishes available upon request.
<b>Mounting Spacers and Brackets:</b>	Copper alloy or steel with zinc plate and chromate seal or tin plate; stainless steel, passivated.
<b>Jackscrew System:</b>	Brass or steel with zinc plate and chromate seal or clear zinc plate or tin plate; stainless steel, passivated.
<b>Vibration Lock Systems:</b>	Lock tabs, nickel plated steel.

Low magnetic versions are available, contact Technical Sales.

### MECHANICAL CHARACTERISTICS:

<b>Contacts Solid Metal Construction:</b>	Size 20 contact, male - 0.040 inch [1.02mm] mating diameter. Female contact - rugged open entry design or PosiBand closed entry design, see page 1 for details.
<b>Contact Retention In Insulator:</b>	5 lbs. [21 N] minimum.
<b>Connector Polarization:</b>	Trapezoidal shaped shells and polarized jackscrews.
<b>Locking System:</b>	Jackscrews and vibration locking systems.
<b>Mechanical Operations:</b>	500 operations per IEC 60512-5 for open entry 1000 operations per IEC 60512-5 for closed entry

### ELECTRICAL CHARACTERISTICS:

<b>Contact Current Rating:</b>	
<b>Open Entry Contacts:</b>	7.5 amperes nominal
<b>Closed Entry Contacts, tested per UL 1977:</b>	18 amperes, 2 contacts energized. 14 amperes, 6 contacts energized. 11 amperes, 15 contacts energized. 10 amperes, 25 contacts energized. 9 amperes, 50 contacts energized.
<i>See temperature rise curves on page 2 for details.</i>	
<b>Initial Contact Resistance:</b>	0.008 ohms maximum per IEC 60512-2, Test 2a for open entry. 0.004 ohms maximum for closed entry.
<b>Proof Voltage:</b>	1000 V r.m.s.
<b>Insulation Resistance:</b>	5 G ohms.
<b>Clearance and Creepage Distance [minimum]:</b>	0.039 inch [1.0mm].
<b>Working Voltage:</b>	300 V.

### ELECTRICAL CHARACTERISTICS OF COMPLIANT CONNECTION TO PLATED-THROUGH-HOLE OF PRINTED BOARD:

<b>Initial Contact Resistance of Connection:</b>	Less than 0.001 ohms per IEC 60512-2, Test 2a.
<b>Change in Contact Resistance of Connection after Mechanical, Electrical or Climatic Conditioning:</b>	Less than 0.001 ohms increase per IEC 60512-2, Test 2a.
<b>Gas-tight Connections Test:</b>	Less than 0.001 ohms increase in contact resistance after 1 hour per EIA 364, TP36, Method One.

### CLIMATIC CHARACTERISTICS:

<b>Temperature Range:</b>	-55°C to +125°C.
---------------------------	------------------



**CONTACT VARIANTS**

FACE VIEW OF MALE CONNECTOR OR REAR VIEW OF FEMALE CONNECTOR

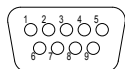

**PCD 9**

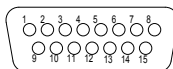

**PCD 15**

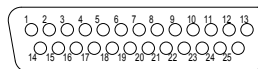

**PCD 25**

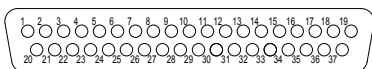

**PCD 37**

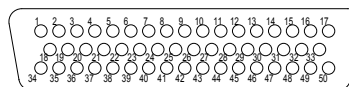

**PCD 50**

**STANDARD SHELL ASSEMBLY**

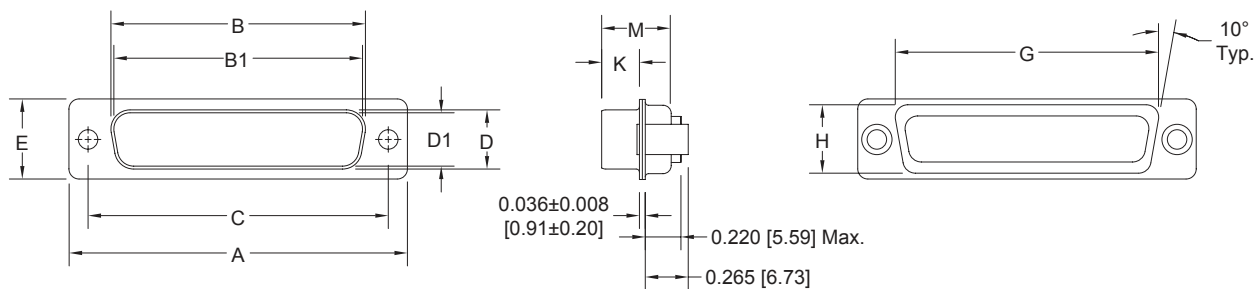

CONNECTOR VARIANT SIZES	A ±0.015 [0.38]	B ±0.005 [0.13]	B1 ±0.005 [0.13]	C ±0.005 [0.13]	D ±0.005 [0.13]	D1 ±0.005 [0.13]	E ±0.015 [0.38]	G ±0.010 [0.25]	H ±0.010 [0.25]	K ±0.005 [0.13]	M ±0.010 [0.25]
<b>PCD 9 M</b>	1.213 [30.81]		0.666 [16.92]	0.984 [24.99]		0.329 [8.36]	0.494 [12.55]	0.759 [19.28]	0.422 [10.72]	0.233 [5.92]	0.422 [10.72]
<b>PCD 9 F</b> <b>PCD 9 S</b>	1.213 [30.81]	0.643 [16.33]		0.984 [24.99]	0.311 [7.90]		0.494 [12.55]	0.759 [19.28]	0.422 [10.72]	0.243 [6.17]	0.429 [10.90]
<b>PCD 15 M</b>	1.541 [39.14]		0.994 [25.25]	1.312 [33.32]		0.329 [8.36]	0.494 [12.55]	1.083 [27.51]	0.422 [10.72]	0.233 [5.92]	0.422 [10.72]
<b>PCD 15 F</b> <b>PCD 15 S</b>	1.541 [39.14]	0.971 [24.66]		1.312 [33.32]	0.311 [7.90]		0.494 [12.55]	1.083 [27.51]	0.422 [10.72]	0.243 [6.17]	0.429 [10.90]
<b>PCD 25 M</b>	2.088 [53.04]		1.534 [38.96]	1.852 [47.04]		0.329 [8.36]	0.494 [12.55]	1.625 [41.28]	0.422 [10.72]	0.230 [5.84]	0.426 [10.82]
<b>PCD 25 F</b> <b>PCD 25 S</b>	2.088 [53.04]	1.511 [38.38]		1.852 [47.04]	0.311 [7.90]		0.494 [12.55]	1.625 [41.28]	0.422 [10.72]	0.243 [6.17]	0.429 [10.90]
<b>PCD 37 M</b>	2.729 [69.32]		2.182 [55.42]	2.500 [63.50]		0.329 [8.36]	0.494 [12.55]	2.272 [57.71]	0.422 [10.72]	0.230 [5.84]	0.426 [10.82]
<b>PCD 37 F</b> <b>PCD 37 S</b>	2.729 [69.32]	2.159 [54.84]		2.500 [63.50]	0.311 [7.90]		0.494 [12.55]	2.272 [57.71]	0.422 [10.72]	0.243 [6.17]	0.429 [10.90]
<b>PCD 50 M</b>	2.635 [66.93]		2.079 [52.81]	2.406 [61.11]		0.441 [11.20]	0.605 [15.37]	2.178 [55.32]	0.534 [13.56]	0.230 [5.84]	0.426 [10.82]
<b>PCD 50 F</b> <b>PCD 50 S</b>	2.635 [66.93]	2.064 [52.43]		2.406 [61.11]	0.423 [10.74]		0.605 [15.37]	2.178 [55.32]	0.534 [13.56]	0.243 [6.17]	0.429 [10.90]



Positronic  
connectpositronic.com

PROFESSIONAL / INDUSTRIAL / MILITARY QUALITY  
COMPLIANT PRESS-FIT  
STANDARD DENSITY D-SUBMINIATURE

D-Sub

PCD SERIES

**RIGHT ANGLE (90°) COMPLIANT PRESS-FIT TERMINATION**  
CODE 62\*1

Positronic recommends the practice of using mounting hardware to secure connector to printed circuit board.

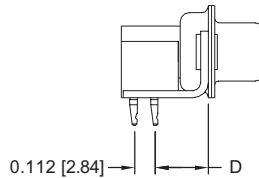

Typical Part Number:  
PCD25S62R7000

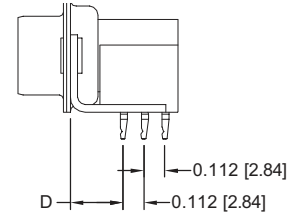
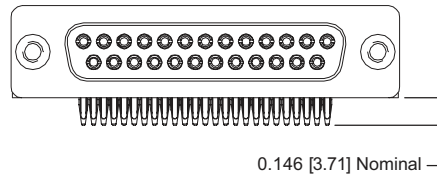

Typical Part Number:  
PCD50S62R7000

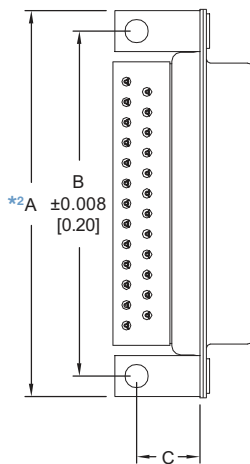

PCD*S62**** 0.283 [7.19] CONTACT EXTENSION				
PART NUMBER*1	A*2	B	C	D
PCD25S62****	2.072 [52.63]	1.852 [47.04]	0.339 [8.61]	0.283 [7.19]
PCD50S62****	2.626 [66.70]	2.406 [61.11]	0.395 [10.03]	0.283 [7.19]

**NOTE:**

- \*1 Currently available in 25 and 50 female variants only, contact Technical Sales for availability of other variants.
- \*2 "A" dimension applies for metal angle brackets only. Consult Accessories D-subminiature Catalog for "A" dimension when plastic brackets are used.

For right angle (90°) compliant press-fit contacts, specify code 62 in step 4 of ordering information.

**SUGGESTED PRINTED BOARD HOLE SIZES:**

For right angle (90°) printed board contact hole pattern, see page 64.

**STRAIGHT COMPLIANT PRESS-FIT TERMINATION**  
CODE 98

Positronic recommends the practice of using mounting hardware to secure connector to printed circuit board.

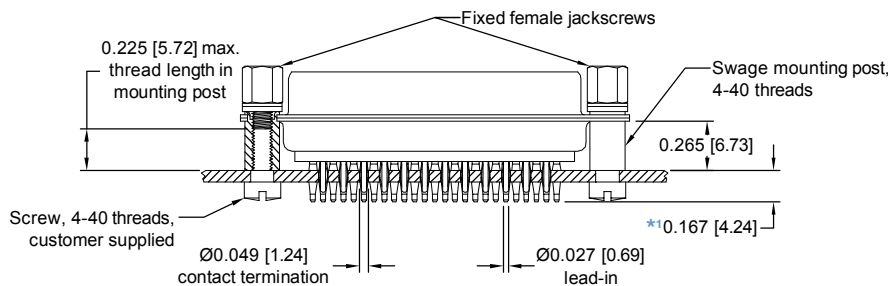

Typical Part Number: PCD25F98S0T20



Detail of  
Omega contacts

For straight compliant press-fit contacts, specify code 98 in step 4 of ordering information.

**NOTE:**

- \*1 The effective length of the compliant section may also be varied (longer or shorter) and can be selectively positioned and centered at several points along the contact termination length, permitting high or low profile mounting of the connector on printed boards.

**SUGGESTED PRINTED BOARD HOLE SIZES:**

For right angle (90°) printed board contact hole pattern, see page 64.

**RIGHT ANGLE (90°) AND STRAIGHT COMPLIANT PRESS-FIT  
 PRINTED BOARD CONTACT HOLE PATTERN**

MOUNT CONNECTOR WITH MATING FACE POSITIONED TO FOLLOW DIRECTION OF ARROW.

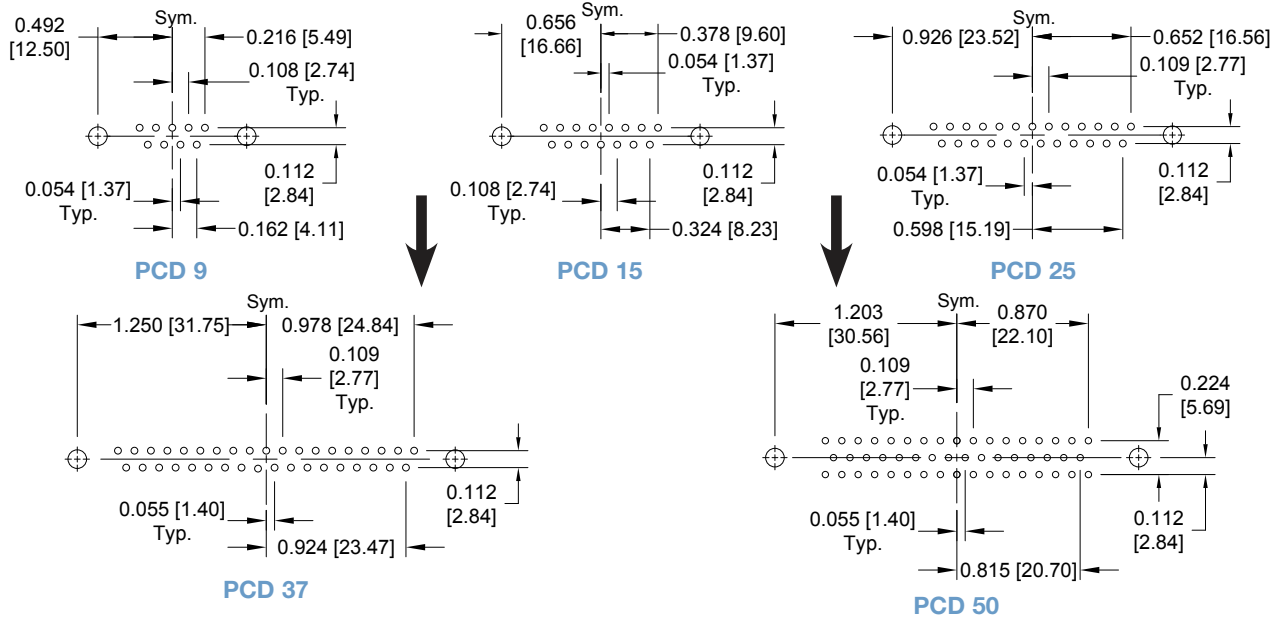

**SUGGESTED PRINTED BOARD HOLE SIZES:**

Suggest 0.120 [3.05] Ø hole for connector mounting holes

**NOTE:** For suggested printed board recommended drill hole sizes, plating and finished hole sizes for compliant contact termination positions, see page 81.  
 For compliant press-fit connector installation tools, see page 80.



Positronic  
connectpositronic.com

PROFESSIONAL / INDUSTRIAL / MILITARY QUALITY  
COMPLIANT PRESS-FIT  
STANDARD DENSITY D-SUBMINIATURE

D-Sub

ORDERING INFORMATION - CODE NUMBERING SYSTEM

Specify Complete Connector By Selecting An Option From Step 1 Through 8

STEP	1	2	3	4	5	6	7	8	9	10
EXAMPLE	PCD	25	F	98	S	0	0	X	/AA	-14

**STEP 1 - BASIC SERIES**

PCD series

**STEP 2 - CONNECTOR VARIANTS**

9, 15, 25, 37, 50

**STEP 3 - CONNECTOR GENDER**

- M - Male
- F - Female - Professional Level open entry contacts
- S - Female - Industrial Level PosiBand closed entry contacts

*Military plating options available.*

**STEP 4 - CONTACT TERMINATION TYPE**

- \*162 - Right angle (90°) printed circuit board mount, compliant press-fit
- 98 - Straight printed circuit board mount, compliant press-fit

**STEP 5 - MOUNTING STYLE**

- B3 - Bracket, Mounting, Right Angle (90°) Metal with Cross Bar.
- R2 - Bracket, Mounting, Right Angle (90°) Metal, Swaged to Connector with 4-40 Thread Fixed Female Jackscrews with Cross Bar.
- R6 - Bracket, Mounting, Right Angle (90°) Metal, Swaged to Connector with 0.120 [3.05] Ø Mounting Hole with Cross Bar.
- R7 - Bracket, Mounting, Right Angle (90°) Metal, Swaged to Connector with 4-40 Threads with Cross Bar.
- R8 - Bracket, Mounting, Right Angle (90°) Metal, Swaged to Connector with 4-40 Locknut with Cross Bar.
- S - Swaged Mounting Post 4-40 Threads 0.265 [6.73] Length.

**NOTE:** Once you have made a connector selection, contact Technical Sales if you would like to receive a drawing in DXF, PDF format or a 3-dimensional IGES, STEP, or SOLIDWORKS file.

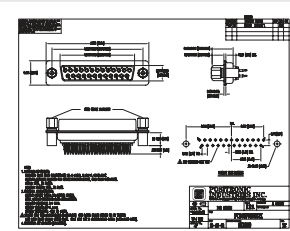

2-D Drawing



3-D Model

**STEP 10 - SPECIAL OPTIONS**

- 14 - 0.000030 [0.76µ] gold over nickel.
- 15 - 0.000050 [1.27µ] gold over nickel.

**CONTACT TECHNICAL SALES FOR SPECIAL OPTIONS**

**STEP 9 - ENVIRONMENTAL COMPLIANCE OPTIONS**

/AA - RoHS Compliant

**NOTE:** If compliance to environmental legislation is not required, this step will not be used. Example: PCD25F98S00X

**STEP 8 - Shell Options**

- 0 - Zinc plated, with chromate seal.
- \*3S - Stainless steel, passivated.
- X - Tin plated.
- Z - Tin plated and dimpled (male connectors only).

**STEP 7 - LOCKING AND POLARIZING SYSTEMS**

- 0 - None.
- \*2V3 - Lock Tab.
- T6 - Fixed Male and Female Polarized Jackscrews.
- T2 - Fixed Female Jackscrews, 4-40 Thread.

**Note:** These options must be ordered with connector and cannot be ordered separately.

**STEP 6 - HOODS**

- 0 - None.

\*1 Available in 25 and 50 female variants only, contact Technical Sales for availability of other variants.

\*2 V3 locking systems are not available for connector variants 37 and 50. Jackscrews are highly recommended to minimize damage to contacts on variants with high mating forces.

\*3 For stainless steel dimpled male versions contact Technical Sales.

For information regarding **COMPLIANT PRESS-FIT INSTALLATION TOOLS**, see pages 80.





Size 22 Contacts  
 Machined Compliant Press-Fit

Three Performance  
 Levels For Best Cost /  
 Performance Ratio

UL & CUL Recognized Telecommunication  
 File #E49351 UL File #E140980



PCDD series connectors are quality connectors with compliant terminations. The low press-in force required to install the contacts into the board eliminates printed board pressure-warp and twisting stresses which can result in expensive repair or replacement of printed boards and back panels.

Six standard connector variants are offered in arrangements of 15, 26, 44, 62, 72, and 104 contacts. PCDD connectors are mateable and compatible with all D-subminiature connectors conforming to dimensional requirements of MIL-DTL-24308.

## PCDD COMPLIANT PRESS-D CONNECTOR TECHNICAL CHARACTERISTICS

### MATERIALS AND FINISHES:

<b>Insulator:</b>	Glass filled polyester per ASTM D5927, UL 94V-0, blue color.
<b>Contacts:</b>	Precision machined copper alloy.
<b>Contact Plating:</b>	Professional performance - Gold flash over nickel plate. Other finishes available upon request.
<b>Shells:</b>	Steel with tin plate; zinc plate with chromate seal, stainless steel passivated. Other materials and finishes available upon request.
<b>Mounting Spacers and Brackets:</b>	Copper alloy or steel with zinc plate and chromate seal or tin plate; stainless steel, passivated.
<b>Jackscrew System:</b>	Brass or steel with zinc plate and chromate seal or clear zinc plate or tin plate; stainless steel, passivated.
<b>Vibration Lock Systems:</b>	Lock tabs, nickel plated steel.
<b>Low magnetic versions are available, contact Technical Sales.</b>	

### MECHANICAL CHARACTERISTICS:

<b>Contacts Solid Metal Construction:</b>	Size 22 contact, male - 0.030 inch [0.76 mm] mating diameter. Female contact - rugged open entry design or PosiBand closed entry design, see page 1 for details.
<b>Contact Retention In Insulator:</b>	5 lbs. [21 N] minimum.
<b>Connector Polarization:</b>	Trapezoidal shaped shells and polarized jackscrews.
<b>Locking System:</b>	Jackscrews and vibration locking systems.
<b>Mechanical Operations:</b>	500 operations per IEC 60512-5 for open entry contacts. 1,000 operations per IEC 60512-5 for PosiBand closed entry contacts.

### CLIMATIC CHARACTERISTICS:

<b>Temperature Range:</b>	-55°C to +125°C.
---------------------------	------------------

### ELECTRICAL CHARACTERISTICS OF CONNECTOR:

<b>Contact Current Rating:</b>	
<b>Open Entry Contacts:</b>	5 amperes nominal
<b>Closed Entry Contacts, tested per UL 1977:</b>	
	12 amperes, 2 contacts energized.
	10 amperes, 6 contacts energized.
	7.5 amperes, 26 contacts energized.
	6.5 amperes, 62 contacts energized.
	5.0 amperes, 104 contacts energized.
<i>See temperature rise curves on page 2 for details.</i>	
<b>Initial Contact Resistance:</b>	0.010 ohms maximum per IEC 60512-2, Test 2a for open entry.
	0.005 ohms maximum for closed entry.
<b>Proof Voltage:</b>	1000 V r.m.s.
<b>Insulation Resistance:</b>	5 G ohms.
<b>Clearance and Creepage Distance [minimum]:</b>	0.042 inch [1.02 mm].
<b>Working Voltage:</b>	300 V.

### ELECTRICAL CHARACTERISTICS OF COMPLIANT CONNECTION TO PLATED-THROUGH-HOLE OF PRINTED BOARD:

<b>Initial Contact Resistance of Connection:</b>	Less than 0.001 ohms per IEC 60512-2, Test 2a.
<b>Change in Contact Resistance of Connection after Mechanical, Electrical or Climatic Conditioning:</b>	Less than 0.001 ohms increase per IEC 60512-2, Test 2a.
<b>Gas-tight Connections Test:</b>	Less than 0.001 ohms increase in contact resistance after 1 hour per EIA 364, TP36, Method One.



Positronic  
connectpositronic.com

PROFESSIONAL / INDUSTRIAL / MILITARY QUALITY  
COMPLIANT PRESS-FIT  
HIGH DENSITY D-SUBMINIATURE

D-Sub

CONTACT VARIANTS

FACE VIEW OF MALE AND REAR VIEW OF FEMALE

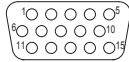

PCDD 15

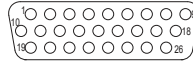

PCDD 26

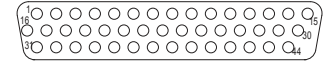

PCDD 44

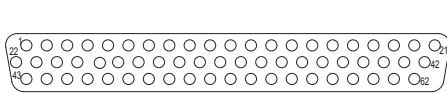

PCDD 62

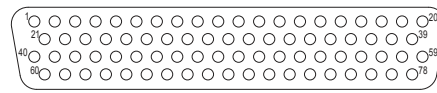

PCDD 78

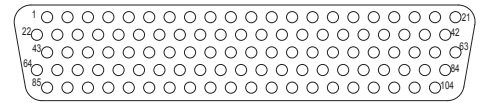

PCDD 104

STANDARD SHELL ASSEMBLY

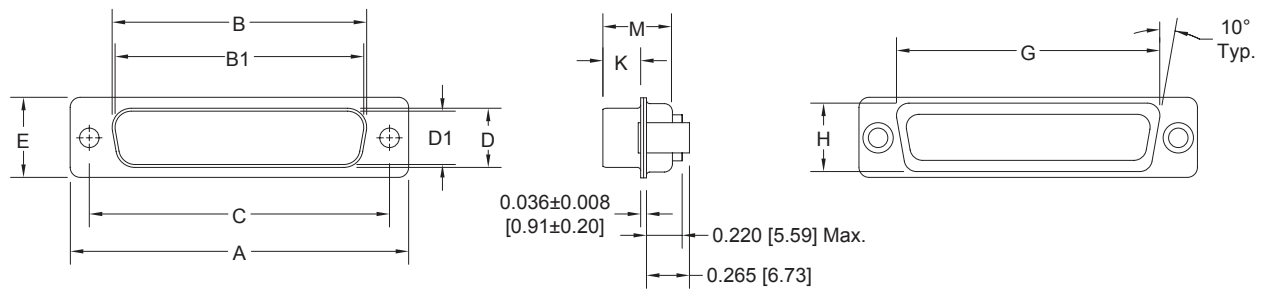

CONNECTOR VARIANT SIZES	A ±0.015 [0.38]	B ±0.005 [0.13]	B1 ±0.005 [0.13]	C ±0.005 [0.13]	D ±0.005 [0.13]	D1 ±0.005 [0.13]	E ±0.015 [0.38]	G ±0.010 [0.25]	H ±0.010 [0.25]	K ±0.005 [0.13]	M ±0.010 [0.25]
PCDD 15 M	1.213 [30.81]		0.666 [16.92]	0.984 [24.99]		0.329 [8.36]	0.494 [12.55]	0.759 [19.28]	0.422 [10.72]	0.233 [5.92]	0.422 [10.72]
PCDD 15 F	1.213 [30.81]	0.643 [16.33]		0.984 [24.99]	0.311 [7.90]		0.494 [12.55]	0.759 [19.28]	0.422 [10.72]	0.243 [6.17]	0.429 [10.90]
PCDD 15 S											
PCDD 26 M	1.541 [39.14]		0.994 [25.25]	1.312 [33.32]		0.329 [8.36]	0.494 [12.55]	1.083 [27.51]	0.422 [10.72]	0.233 [5.92]	0.422 [10.72]
PCDD 26 F	1.541 [39.14]	0.971 [24.66]		1.312 [33.32]	0.311 [7.90]		0.494 [12.55]	1.083 [27.51]	0.422 [10.72]	0.243 [6.17]	0.429 [10.90]
PCDD 26 S											
PCDD 44 M	2.088 [53.04]		1.534 [38.96]	1.852 [47.04]		0.329 [8.36]	0.494 [12.55]	1.625 [41.28]	0.422 [10.72]	0.230 [5.84]	0.426 [10.82]
PCDD 44 F	2.088 [53.04]	1.511 [38.38]		1.852 [47.04]	0.311 [7.90]		0.494 [12.55]	1.625 [41.28]	0.422 [10.72]	0.243 [6.17]	0.429 [10.90]
PCDD 44 S											
PCDD 62 M	2.729 [69.32]		2.182 [55.42]	2.500 [63.50]		0.329 [8.36]	0.494 [12.55]	2.272 [57.71]	0.422 [10.72]	0.230 [5.84]	0.426 [10.82]
PCDD 62 F	2.729 [69.32]	2.159 [54.84]		2.500 [63.50]	0.311 [7.90]		0.494 [12.55]	2.272 [57.71]	0.422 [10.72]	0.243 [6.17]	0.429 [10.90]
PCDD 62 S											
PCDD 78 M	2.635 [66.93]		2.079 [52.81]	2.406 [61.11]		0.441 [11.20]	0.605 [15.37]	2.178 [55.32]	0.534 [13.56]	0.230 [5.84]	0.426 [10.82]
PCDD 78 F	2.635 [66.93]	2.064 [52.43]		2.406 [61.11]	0.423 [10.74]		0.605 [15.37]	2.178 [55.32]	0.534 [13.56]	0.243 [6.17]	0.429 [10.90]
PCDD 78 S											
PCDD 104 M	2.729 [69.32]		2.212 [56.18]	2.500 [63.50]		0.503 [12.78]	0.668 [16.97]	2.302 [58.47]	0.596 [15.14]	0.230 [5.84]	0.426 [10.82]
PCDD 104 F	2.729 [69.32]	2.189 [55.60]		2.500 [63.50]	0.485 [12.32]		0.668 [16.97]	2.302 [58.47]	0.596 [15.14]	0.243 [6.17]	0.429 [10.90]
PCDD 104 S											

PCDD SERIES



**RIGHT ANGLE (90°) COMPLIANT PRESS-FIT TERMINATION**  
**CODE 62\*1**

Positronic recommends the practice of using mounting hardware to secure connector to printed circuit board.

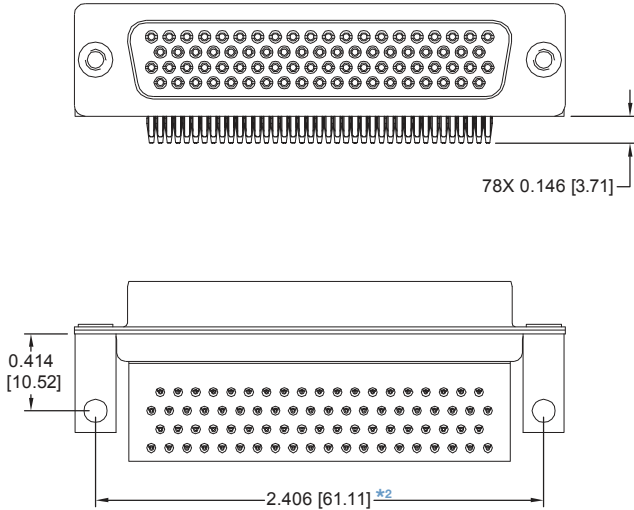

Typical Part Number:  
**PCDD78S62R7000**

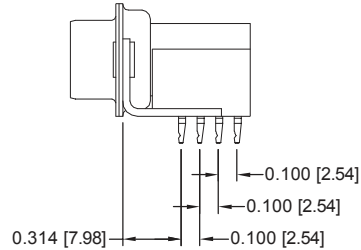

For right angle (90°) compliant press-fit contacts, specify code 62 in step 4 of ordering information.

**NOTE:**

- \*1 Currently available in 78 female variants only, contact Technical Sales for availability of other variants.
- \*2 Dimension applies for metal angle brackets only. Consult Accessories D-subminiature Catalog for dimension when plastic brackets are used.

**SUGGESTED PRINTED BOARD HOLE SIZES:**

For right angle (90°) printed board contact hole pattern, see page 69.

**STRAIGHT COMPLIANT PRESS-FIT TERMINATION**  
**CODE 98**

Positronic recommends the practice of using mounting hardware to secure connector to printed circuit board.

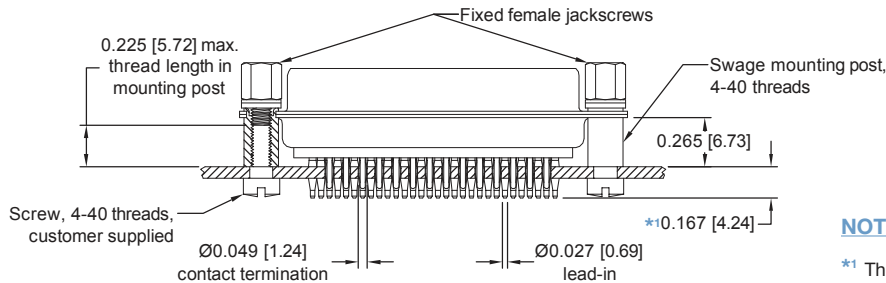

Typical Part Number:  
**PCDD44F98S0T20**

For straight compliant press-fit contacts, specify code 98 in step 4 of ordering information.

**NOTE:**

- \*1 The effective length of the compliant section may also be varied (longer or shorter) and can be selectively positioned and centered at several points along the contact termination length, permitting high or low profile mounting of the connector on printed boards.



Detail of Omega contacts

**SUGGESTED PRINTED BOARD HOLE SIZES:**

For right angle (90°) printed board contact hole pattern, see page 69.



### RIGHT ANGLE (90°) AND STRAIGHT COMPLIANT PRESS-FIT PRINTED BOARD CONTACT HOLE PATTERN

MOUNT CONNECTOR WITH MATING FACE POSITIONED TO FOLLOW DIRECTION OF ARROW.

PCDD15 MALE

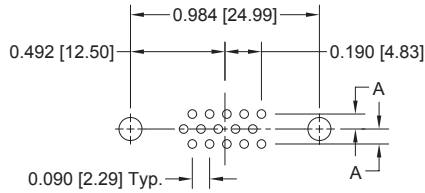

PCDD15 FEMALE

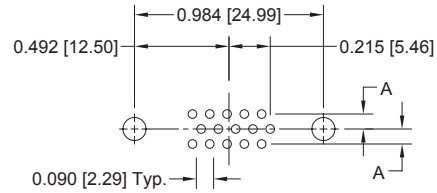

PCDD26 MALE

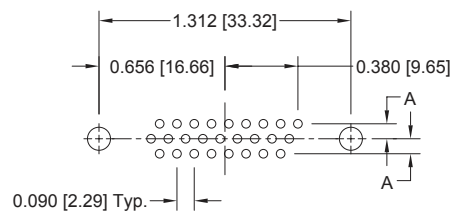

PCDD26 FEMALE

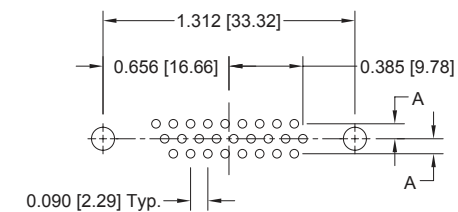

PCDD44 MALE

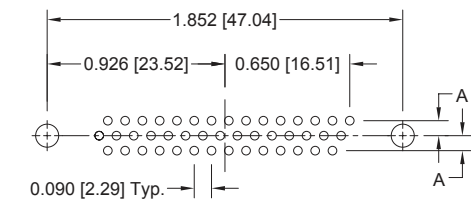

PCDD44 FEMALE

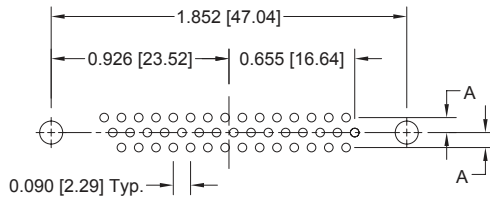

PCDD62 MALE

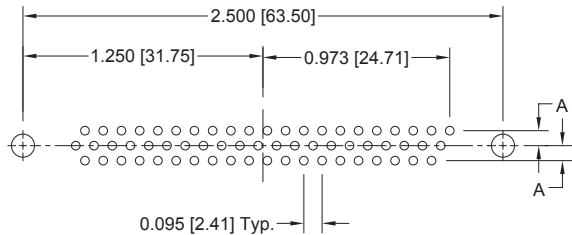

PCDD62 FEMALE

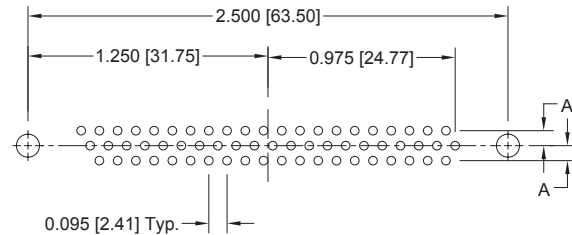

PCDD78 MALE

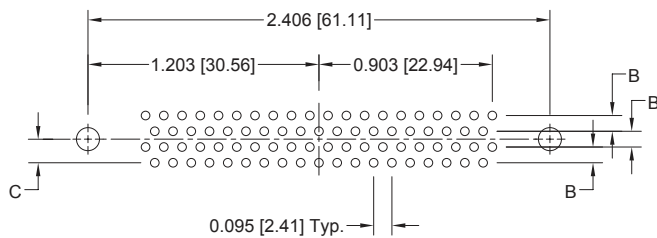

PCDD78 FEMALE

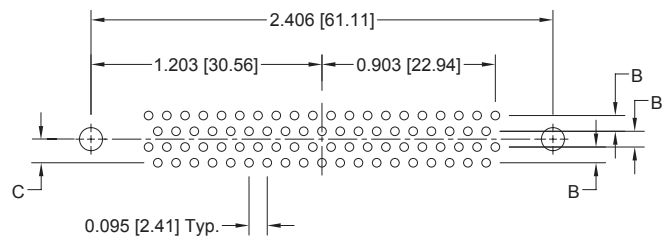

PCDD104 MALE

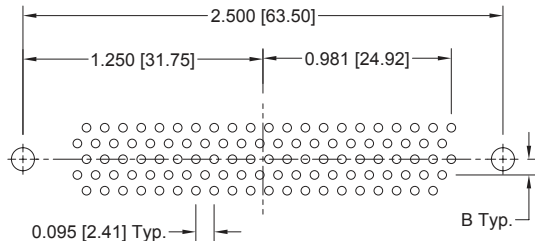

PCDD104 FEMALE

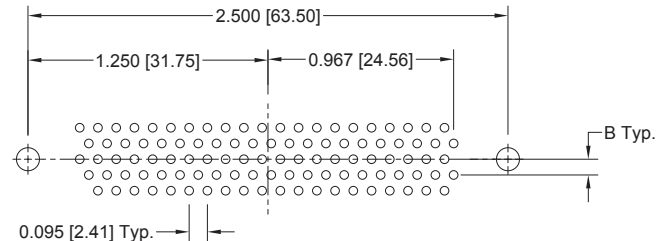

CODE NUMBER	A	B	C
62	0.100 [2.54]	0.100 [2.54]	0.100 [2.54]
98	0.078 [1.98]	0.082 [2.08]	0.123 [3.12]

#### SUGGESTED PRINTED BOARD HOLE SIZES:

Suggest 0.120 [3.05] Ø hole for connector mounting holes.

**NOTE:** For suggested printed board recommended drill hole sizes, plating and finished hole sizes for compliant contact termination positions, see page 81. For compliant press-fit connector installation tools, see page 80.



## ORDERING INFORMATION - CODE NUMBERING SYSTEM

Specify Complete Connector By Selecting An Option From Step 1 Through 8

STEP	1	2	3	4	5	6	7	8	9	10
EXAMPLE	PCDD	15	M	98	S	0	T2	0	/AA	-14
<b>STEP 1 - BASIC SERIES</b> PCDD series										<b>STEP 10 - SPECIAL OPTIONS</b> -14 - 0.000030 [0.76µ] gold over nickel. -15 - 0.000050 [1.27µ] gold over nickel. <b>CONTACT TECHNICAL SALES FOR SPECIAL OPTIONS</b>
<b>STEP 2 - CONNECTOR VARIANTS</b> 15, 26, 44, 62, 78, 104										<b>STEP 9 - ENVIRONMENTAL COMPLIANCE OPTIONS</b> /AA - RoHS Compliant  <b>NOTE:</b> If compliance to environmental legislation is not required, this step will not be used. Example: PCDD15M98S0T20
<b>STEP 3 - CONNECTOR GENDER</b> M - Male F - Female - Professional Level open entry contacts S - Female - Industrial Level PosiBand closed entry contacts. <i>Military plating options available.</i>										<b>STEP 8 - Shell Options</b> 0 - Zinc plated, with chromate seal. *3S - Stainless steel, passivated. X - Tin plated. Z - Tin plated and dimpled (male connectors only).
<b>STEP 4 - CONTACT TERMINATION TYPE</b> *162 - Right angle (90°) printed circuit board mount, compliant press-fit 98 - Straight printed circuit board mount, compliant press-fit										<b>STEP 7 - LOCKING AND POLARIZING SYSTEMS</b> 0 - None. *2 V3 - Lock Tab. T6 - Fixed Male and Female Polarized Jackscrews. T2 - Fixed Female Jackscrews, 4-40 Thread.  <b>Note:</b> These options must be ordered with connector and cannot be ordered separately.
<b>STEP 5 - MOUNTING STYLE</b> B3 - Bracket, Mounting, Right Angle (90°) Metal with Cross Bar. R2 - Bracket, Mounting, Right Angle (90°) Metal, Swaged to Connector with 4-40 Thread Fixed Female Jackscrews with Cross Bar. R6 - Bracket, Mounting, Right Angle (90°) Metal, Swaged to Connector with 0.120 [3.05] Ø Mounting Hole with Cross Bar. R7 - Bracket, Mounting, Right Angle (90°) Metal, Swaged to Connector with 4-40 Threads with Cross Bar. R8 - Bracket, Mounting, Right Angle (90°) Metal, Swaged to Connector with 4-40 Locknut with Cross Bar. S - Swaged Mounting Post 4-40 Threads 0.265 [6.73] Length.										<b>STEP 6 - HOODS</b> 0 - None.

PCDD SERIES

**NOTE:** Once you have made a connector selection, contact Technical Sales if you would like to receive a drawing in DXF, PDF format or a 3-dimensional IGES, STEP, or SOLIDWORKS file.

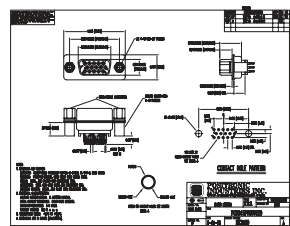

2-D Drawing

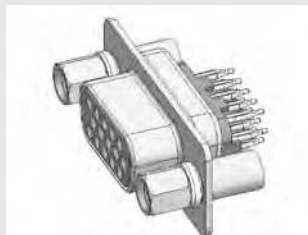

3-D Model

\*1 Available in 78 female variant only, contact Technical Sales for availability of other variants.

\*2 V3 locking systems are not available for connector variants 62 and 78. Jackscrews are highly recommended to minimize damage to contacts on variants with high mating forces.

\*3 For stainless steel dimpled male versions contact Technical Sales.

For information regarding **COMPLIANT PRESS-FIT INSTALLATION TOOLS**, see pages 80.



**AD Series  
Size 20 “Open Entry”  
Contact Design**

**HAD Series  
Size 20 PosiBand® “Closed  
Entry” Contact Design**

**Connector Saver**



AD and HAD series connectors are suitable for use in any applications requiring high performance characteristic. The normal density AD and HAD series are available in five standard connector variants of 9, 15, 25, 37 and 50 contacts.

AD and HAD series connectors utilize precision machined contacts for strength and durability. AD series female contact features a rugged open entry design. HAD series female contact features the PosiBand closed entry design for even higher reliability, see page 1 for details.

AD and HAD series connectors can be mated to a connector which would normally experience high numbers of mating cycles. The AD/HAD connector can be easily replaced, “saving” a connector which is not easily replaced.

These connectors can also be used as a “gender changer”. Connectors are available in high density versions, see page 75.

CONNECTOR SAVERS

## TECHNICAL CHARACTERISTICS

### MATERIALS AND FINISHES:

**Insulator:**  
**AD series:** Nylon resin, UL 94V-0, black color.  
**HAD series:** Glass-filled DAP per ASTM-D-5948, UL 94V-0.

**Contacts:** Precision machined copper alloy.  
**Contact Plating:** Gold flash over nickel plate. Other finishes available upon request.

**Shells:** Steel with tin plate; zinc plate with chromate seal, stainless steel passivated. Other materials and finishes available upon request.

Low magnetic versions are available, contact Technical Sales.

### MECHANICAL CHARACTERISTICS:

**Fixed Contacts:** Size 20 contacts, male - 0.040 inch [1.02 mm] mating diameter. AD series female contact offers open entry design. HAD series female contact features PosiBand closed entry design, see page 1 for details.

**Connector Saver:** Male to female or male to male.

**Contact Retention:** 9 lbs. [40 N].

**Shells:** Male shells may be dimpled for EMI/ESD ground paths.

**Polarization:** Trapezoidally shaped shells.

**Mechanical Operations:**  
**AD series:** 500 operations, minimum, per IEC 60512-5.  
**HAD series:** 1,000 operations, minimum, per IEC 60512-5.

### ELECTRICAL CHARACTERISTICS:

#### Contact Current Rating:

**Open Entry Contacts:** 7.5 amperes nominal

#### Closed Entry Contacts, tested per UL 1977:

- 18 amperes, 2 contacts energized.
- 14 amperes, 6 contacts energized.
- 11 amperes, 15 contacts energized.
- 10 amperes, 25 contacts energized.
- 9 amperes, 50 contacts energized.

See temperature rise curves on page 2 for details.

**Initial Contact Resistance:** 0.008 ohms, maximum for AD series.  
0.004 ohms, maximum for HAD series.

**Proof Voltage:** 1,000 V r.m.s.

**Insulation Resistance:** 5 G ohms.

**Clearance and Creepage Distance:** 0.039 inch [1.0 mm], minimum.

**Working Voltage:** 300 V r.m.s.

### CLIMATIC CHARACTERISTICS:

**Temperature Range:** -55°C to +125°C.



AD AND HAD SERIES SIZE 20 CONTACT CONNECTOR SAVER

CONTACT VARIANTS

FACE VIEW OF MALE OR USE MIRROR IMAGE FOR FEMALE

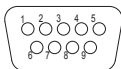

SIZE 9

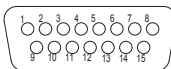

SIZE 15

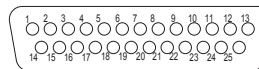

SIZE 25

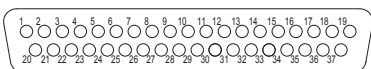

SIZE 37

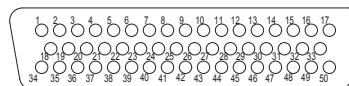

SIZE 50

STANDARD SHELL ASSEMBLY DIMENSIONS  
SIZE 20 CONTACTS

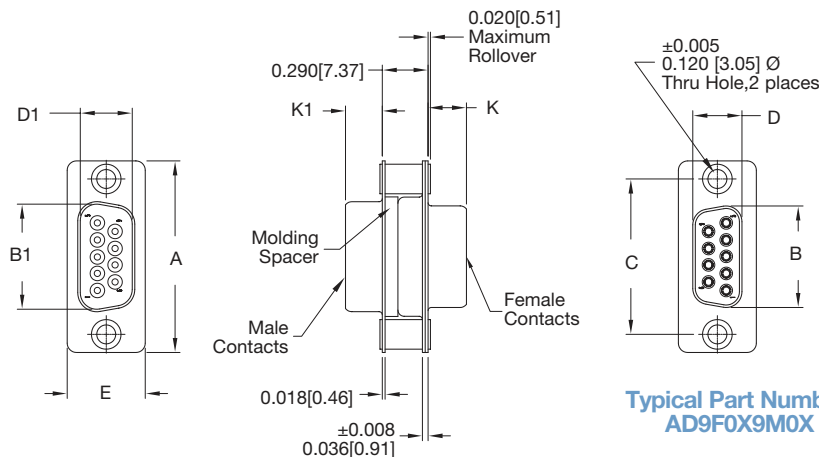

Typical Part Number:  
AD9FOX9M0X

CONNECTOR VARIANT SIZES	A ±0.015 [0.38]	B ±0.005 [0.13]	B1 ±0.005 [0.13]	C ±0.005 [0.13]	D ±0.005 [0.13]	D1 ±0.005 [0.13]	E ±0.015 [0.38]	K ±0.005 [0.13]	K1 ±0.005 [0.13]
9 M	1.213 [30.81]		0.666 [16.92]	0.984 [24.99]		0.329 [8.36]	0.494 [12.55]		0.233 [5.92]
9 F	1.213 [30.81]	0.643 [16.33]		0.984 [24.99]	0.311 [7.90]		0.494 [12.55]	0.243 [6.17]	
15 M	1.541 [39.14]		0.994 [25.25]	1.312 [33.32]		0.329 [8.36]	0.494 [12.55]		0.233 [5.92]
15 F	1.541 [39.14]	0.971 [24.66]		1.312 [33.32]	0.311 [7.90]		0.494 [12.55]	0.243 [6.17]	
25 M	2.088 [53.04]		1.534 [38.96]	1.852 [47.04]		0.329 [8.36]	0.494 [12.55]		0.230 [5.84]
25 F	2.088 [53.04]	1.511 [38.38]		1.852 [47.04]	0.311 [7.90]		0.494 [12.55]	0.243 [6.17]	
37 M	2.729 [69.32]		2.182 [55.42]	2.500 [63.50]		0.329 [8.36]	0.494 [12.55]		0.230 [5.84]
37 F	2.729 [69.32]	2.159 [54.84]		2.500 [63.50]	0.311 [7.90]		0.494 [12.55]	0.243 [6.17]	
50 M	2.635 [66.93]		2.079 [52.81]	2.406 [61.11]		0.441 [11.20]	0.605 [15.37]		0.230 [5.84]
50 F	2.635 [66.93]	2.064 [52.43]		2.406 [61.11]	0.423 [10.74]		0.605 [15.37]	0.243 [6.17]	



**JACKSCREW SYSTEMS**  
CODE E, E6, T AND T6

ROTATING  
MALE AND FEMALE  
JACKSCREWS

E

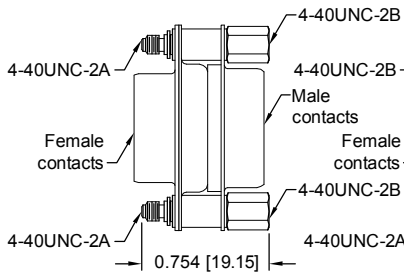

Example Part Number:  
AD9FEX9M0X

ROTATING  
MALE AND FEMALE  
POLARIZED  
JACKSCREWS

E6

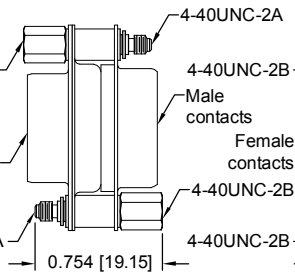

Example Part Number:  
AD9FE6X9M0X

FIXED  
MALE AND FEMALE  
JACKSCREWS

T

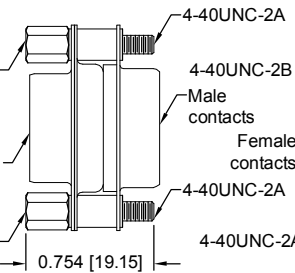

Example Part Number:  
AD9FTX9M0X

FIXED  
MALE AND FEMALE  
POLARIZED  
JACKSCREWS

T6

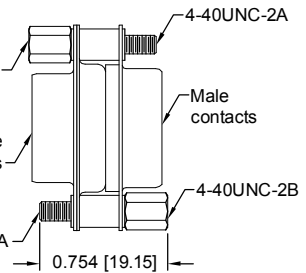

Example Part Number:  
AD9FT6X9M0X

**MATERIAL:** Brass or steel with zinc plate and chromate seal or clear zinc plate or tin plate; stainless steel, passivated.

# Connectors Designed To Customer Specifications

*Positronic D-subminiature connectors can be modified to customer specifications.*

**Examples:** select loading of contacts for cost savings or to gain creepage and clearance distances; longer printed circuit board terminations; customer specified hardware; sealing for water resistance.

*Contact Technical Sales with your particular requirements.*





**ORDERING INFORMATION - CODE NUMBERING SYSTEM**

Specify Complete Connector By Selecting An Option From Step 1 Through 9

STEP	1	2	3	4	5	6	7	8	9	10	11
EXAMPLE	AD	9	F	S	X	9	M	S	X	/AA	-14

**STEP 1 - BASIC SERIES**

AD series - Open entry female contacts, nylon insulator  
HAD series - PosiBand closed entry female contacts, DAP insulator.  
*Military plating options available.*

**STEP 2 - CONNECTOR VARIANT**

9, 15, 25, 37, 50

**STEP 3 - 1<sup>ST</sup> CONNECTOR GENDER**

M - Male  
F - Female

**\*1 STEP 4 - 1<sup>ST</sup> CONNECTOR MATING STYLE**

- 0 - Swaged spacer 0.120 [3.05μ] mounting hole
- S - Swaged spacer 4-40 UNC-2B threads
- \*3 E - Rotating male and female jackscrews (Select 0 in Step 8)
- \*3 E6 - Rotating male and female polarized jackscrew (Select 0 in Step 8)
- \*3 T - Fixed male and female jackscrews (Select 0 in Step 8)
- \*3 T6 - Fixed male and female polarized jackscrew (Select 0 in Step 8)

**STEP 5 - 1<sup>ST</sup> CONNECTOR SHELL OPTION**

- 0 - Zinc plated, with chromate seal.
- \*4 S - Stainless steel, passivated.
- X - Tin plated.
- Z - Tin plated and dimpled (male connectors only).

**NOTE:** Once you have made a connector selection, contact Technical Sales if you would like to receive a drawing in DXF, PDF format or a 3-dimensional IGES, STEP, or SOLIDWORKS file.

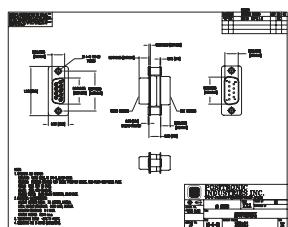

2-D Drawing



3-D Model

**STEP 11 - SPECIAL OPTIONS**

- 14 - 0.000030 [0.76μ] gold over nickel.
- 15 - 0.000050 [1.27μ] gold over nickel.

**CONTACT TECHNICAL SALES FOR SPECIAL OPTIONS**

**STEP 10 - ENVIRONMENTAL COMPLIANCE OPTIONS**

/AA - RoHS Compliant

**NOTE:** If compliance to environmental legislation is not required, this step will not be used. Example: AD9FSX9MSX

**STEP 9 - 2<sup>ND</sup> CONNECTOR SHELL OPTION**

- 0 - Zinc plated, with chromate seal.
- \*4 S - Stainless steel, passivated.
- X - Tin plated.
- Z - Tin plated and dimpled (male connectors only).

**\*1 STEP 8 - 2<sup>ND</sup> CONNECTOR MATING STYLE**

- 0 - Swaged spacer 0.120 [3.05μ] mounting hole
- S - Swaged spacer 4-40 UNC-2B threads
- \*3 E - Rotating male and female jackscrews (Select 0 in Step 4)
- \*3 E6 - Rotating male and female polarized jackscrew (Select 0 in Step 4)
- \*3 T - Fixed male and female jackscrews (Select 0 in Step 4)
- \*3 T6 - Fixed male and female polarized jackscrew (Select 0 in Step 4)

**STEP 7 - 2<sup>ND</sup> CONNECTOR GENDER**

M - Male

**\*2 STEP 6 - 2<sup>ND</sup> CONNECTOR VARIANT**

9, 15, 25, 37, 50

\*1 Connector mating style for both connectors must be the same if 0 or S is used. If E, E6, T or T6 is used in either Step 4 or 8 the other step must be 0.  
\*2 Connector variant for both connectors must be the same.  
\*3 For hardware information, see page 73.  
\*4 For stainless steel dimpled male versions contact Technical Sales.

CONNECTOR SAVERS



**DAD Series  
Size 22  
“Open Entry” or  
PosiBand® “Closed Entry”  
Contact Design**

**Connector Saver**



DAD series connectors are suitable for use in any applications requiring high performance characteristic. The high density DAD series is available in six standard connector variants of 15, 26, 44, 62, 78 and 104 contacts.

DAD series connectors utilize precision machined contacts for strength and durability. The female contact features a rugged open entry design. Female PosiBand closed entry contacts can be chosen for even higher reliability, see page 1 for details.

DAD series connectors can be mated to a connector which would normally experience high numbers of mating cycles. The DAD connector can be easily replaced, “saving” a connector which is not easily replaced.

Connectors are available in standard density versions, see page 71.

## TECHNICAL CHARACTERISTICS

### MATERIALS AND FINISHES:

- Insulator:** Polyester glass-filled per ASTM D5927, UL 94V-0.
- Contacts:** Precision machined copper alloy.
- Contact Plating:** Gold flash over nickel plate. Other finishes available upon request.
- Shells:** Steel or brass with tin plate; zinc plate with chromate seal, stainless steel passivated. Other materials and finishes available upon request.

Low magnetic versions are available, contact Technical Sales.

### MECHANICAL CHARACTERISTICS:

- Fixed Contacts:** Size 22 contacts - male 0.030 inch [0.76 mm] mating diameter. Female contact: open entry or PosiBand closed entry design, see page 1 for details.
- Connector Saver:** Male to female.
- Contact Retention:** 9 lbs. [40 N].
- Shells:** Male shells may be dimpled for EMI/ESD ground paths.
- Polarization:** Trapezoidally shaped shells.

- Mechanical Operations:** 500 operations, minimum, per IEC 60512-5 for open entry.  
1000 operations, minimum, per IEC 60512-5 for closed entry.

### ELECTRICAL CHARACTERISTICS:

#### Contact Current Rating:

- Open Entry Contacts:** 5 amperes nominal
- Closed Entry Contacts, tested per UL 1977:**
  - 12 amperes, 2 contacts energized.
  - 10 amperes, 6 contacts energized.
  - 7.5 amperes, 26 contacts energized.
  - 6.5 amperes, 62 contacts energized.
  - 5.0 amperes, 104 contacts energized.

See temperature rise curves on page 2 for details.

- Initial Contact Resistance:** 0.010 ohms, maximum for open entry  
0.005 ohms, maximum for closed entry
- Proof Voltage:** 1,000 V r.m.s.
- Insulation Resistance:** 5 G ohms.
- Clearance and Creepage Distance:** 0.042 inch [1.06 mm], minimum.
- Working Voltage:** 300 V r.m.s.

### CLIMATIC CHARACTERISTICS:

- Temperature Range:** -55°C to +125°C.



## DAD SERIES SIZE 22 CONTACT CONNECTOR SAVER

### CONTACT VARIANTS

FACE VIEW OF MALE OR USE MIRROR IMAGE FOR FEMALE

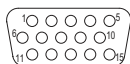

DAD 15

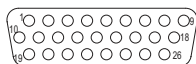

DAD 26

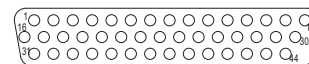

DAD 44

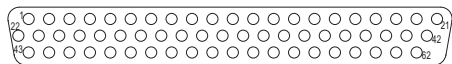

DAD 62

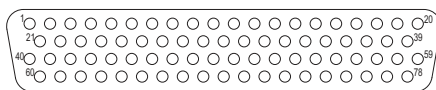

DAD 78

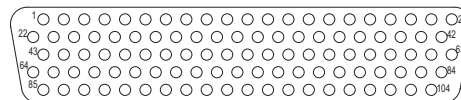

DAD 104

### STANDARD SHELL ASSEMBLY DIMENSIONS

#### SIZE 22 CONTACTS

Typical Part Number:  
DAD15M0X15FOX

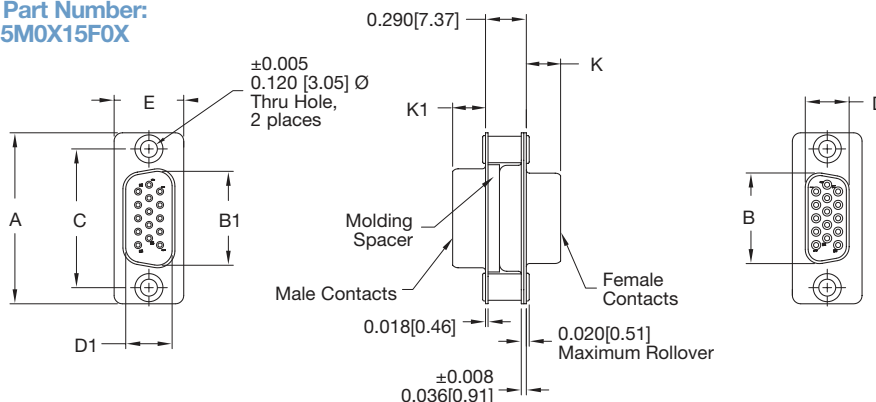

CONNECTOR VARIANT SIZES	A ±0.015 [0.38]	B ±0.005 [0.13]	B1 ±0.005 [0.13]	C ±0.005 [0.13]	D ±0.005 [0.13]	D1 ±0.005 [0.13]	E ±0.015 [0.38]	K ±0.005 [0.13]	K1 ±0.005 [0.13]
15 M	1.213 [30.81]		0.666 [16.92]	0.984 [24.99]		0.329 [8.36]	0.494 [12.55]		0.233 [5.92]
15 F	1.213 [30.81]	0.643 [16.33]		0.984 [24.99]	0.311 [7.90]		0.494 [12.55]	0.243 [6.17]	
15 S									
26 M	1.541 [39.14]		0.994 [25.25]	1.312 [33.32]		0.329 [8.36]	0.494 [12.55]		0.233 [5.92]
26 F	1.541 [39.14]	0.971 [24.66]		1.312 [33.32]	0.311 [7.90]		0.494 [12.55]	0.243 [6.17]	
26 S									
44 M	2.088 [53.04]		1.534 [38.96]	1.852 [47.04]		0.329 [8.36]	0.494 [12.55]		0.230 [5.84]
44 F	2.088 [53.04]	1.511 [38.38]		1.852 [47.04]	0.311 [7.90]		0.494 [12.55]	0.243 [6.17]	
44 S									
62 M	2.729 [69.32]		2.182 [55.42]	2.500 [63.50]		0.329 [8.36]	0.494 [12.55]		0.230 [5.84]
62 F	2.729 [69.32]	2.159 [54.84]		2.500 [63.50]	0.311 [7.90]		0.494 [12.55]	0.243 [6.17]	
62 S									
78 M	2.635 [66.93]		2.079 [52.81]	2.406 [61.11]		0.441 [11.20]	0.605 [15.37]		0.230 [5.84]
78 F	2.635 [66.93]	2.064 [52.43]		2.406 [61.11]	0.423 [10.74]		0.605 [15.37]	0.243 [6.17]	
78 S									
104 M	2.729 [69.32]		2.212 [56.18]	2.500 [63.50]		0.503 [12.78]	0.668 [16.97]		0.230 [5.84]
104 F	2.729 [69.32]	2.189 [55.60]		2.500 [63.50]	0.485 [12.32]		0.668 [16.97]	0.243 [6.17]	
104 S									



### ORDERING INFORMATION - CODE NUMBERING SYSTEM

Specify Complete Connector By Selecting An Option From Step 1 Through 9

STEP	1	2	3	4	5	6	7	8	9	10	11
EXAMPLE	DAD	15	M	S	X	15	F	S	X	/AA	-14

#### STEP 1 - BASIC SERIES

DAD series

#### STEP 2 - CONNECTOR VARIANT

15, 26, 44, 62, 78, 104

#### STEP 3 - 1<sup>ST</sup> CONNECTOR GENDER

M - Male

#### \*2 STEP 4 - 1<sup>ST</sup> CONNECTOR MATING STYLE

- 0 - Swaged spacer 0.120 [3.05µ] mounting hole
- S - Swaged spacer 4-40 UNC-2B threads
- \*3 E - Rotating male and female jackscrews (Select 0 in Step 8)
- \*3 E6 - Rotating male and female polarized jackscrew (Select 0 in Step 8)
- \*3 T - Fixed male and female jackscrews (Select 0 in Step 8)
- \*3 T6 - Fixed male and female polarized jackscrew (Select 0 in Step 8)

#### STEP 5 - 1<sup>ST</sup> CONNECTOR SHELL OPTION

- 0 - Zinc plated, with chromate seal.
- \*5 S - Stainless steel, passivated.
- X - Tin plated.
- Z - Tin plated and dimpled (male connectors only).

- \*1 Male option available only on connector variant 78.
- \*2 Connector mating style for both connectors must be the same if 0 or S is used. If E, E6, T or T6 is used in either Step 4 or 8 the other step must be 0.
- \*3 For hardware information, see page 73.
- \*4 Connector variant for both connectors must be the same as in Step 2.
- \*5 For stainless steel dimpled male versions contact Technical Sales.

**NOTE:** Once you have made a connector selection, contact Technical Sales if you would like to receive a drawing in DXF, PDF format or a 3-dimensional IGES, STEP, or SOLIDWORKS file.

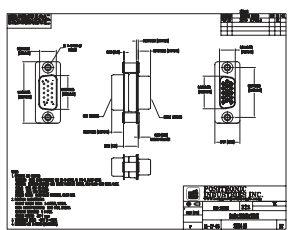

2-D Drawing



3-D Model

#### STEP 11 - SPECIAL OPTIONS

- 14 - 0.000030 [0.76µ] gold over nickel.
  - 15 - 0.000050 [1.27µ] gold over nickel.
- CONTACT TECHNICAL SALES FOR SPECIAL OPTIONS**

#### STEP 10 - ENVIRONMENTAL COMPLIANCE OPTIONS

/AA - RoHS Compliant

**NOTE:** If compliance to environmental legislation is not required, this step will not be used. Example: DAD15MSX15FSX

#### STEP 9 - 2<sup>ND</sup> CONNECTOR SHELL OPTION

- 0 - Zinc plated, with chromate seal.
- \*5 S - Stainless steel, passivated.
- X - Tin plated.
- Z - Tin plated and dimpled (male connectors only).

#### \*\*STEP 8 - 2<sup>ND</sup> CONNECTOR MATING STYLE

- 0 - Swaged spacer 0.120 [3.05µ] mounting hole
- S - Swaged spacer 4-40 UNC-2B threads
- \*3 E - Rotating male and female jackscrews (Select 0 in Step 4)
- \*3 E6 - Rotating male and female polarized jackscrew (Select 0 in Step 4)
- \*3 T - Fixed male and female jackscrews (Select 0 in Step 4)
- \*3 T6 - Fixed male and female polarized jackscrew (Select 0 in Step 4)

#### STEP 7 - 2<sup>ND</sup> CONNECTOR GENDER

- \*1 M - Male
- F - Female - Professional Level - open entry contacts
- S - Female - Industrial Level - PosiBand closed entry contacts

Military plating options available.

#### \*4 STEP 6 - 2<sup>ND</sup> CONNECTOR VARIANT

15, 26, 44, 62, 78, 104



## A P P L I C A T I O N   T O O L S   S E C T I O N

*SD / RD / ORD / ODD / DD connectors are offered with **removable crimp contacts**.*



Positronic recognizes the **importance of** supplying **application tooling** to support our customers' use of our products.

Information on application tooling is **available** on our web site at

[www.connectpositronic.com/design-tools/tooling](http://www.connectpositronic.com/design-tools/tooling)

There you will find **downloadable PDF** cross reference charts for removable and compliant press-fit contacts. These charts will **supply part numbers** for insertion, removal and crimping tools, along with **information regarding use** of tools and techniques.



### REELS FOR AUTOMATIC PNEUMATIC CRIMP TOOLS

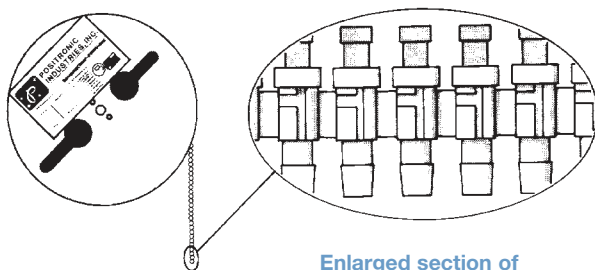

Enlarged section of plastic contact carriers

Contacts may be supplied in plastic carriers, packaged in reels holding 2,000 contacts for use with the automatic pneumatic crimp tools, catalog part number 9550-1. The same type carrier is used for both male and female contacts.

All male and female crimp contacts can be ordered in reels by adding letter "R" after the contact part number, such as MC6020DR for a male contact and FC6020D2R for female contact.





**COMPLIANT PRESS-FIT CONNECTORS INSTALLATION TOOLS**

USE INDICATED POSITRONIC TOOLS FOR BEST RESULTS

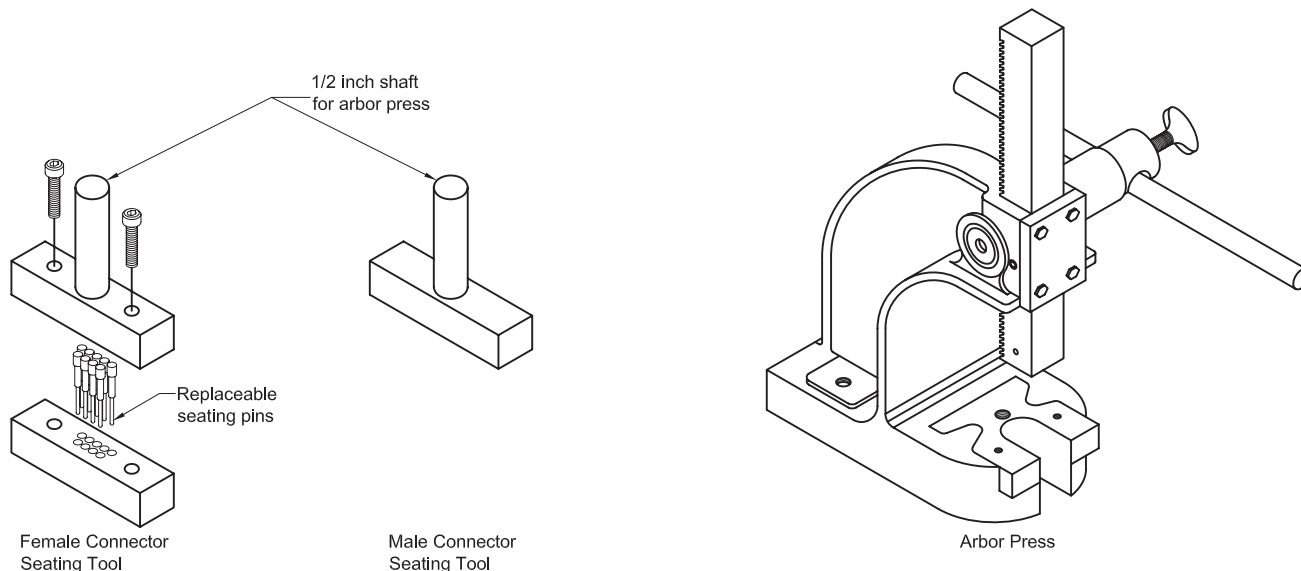

POSITRONIC RECOMMENDED TOOLS FOR PCD SERIES AND PCDD SERIES CONNECTORS AND CONTACTS		
SERIES	CONNECTOR SEATING	
	MALE	FEMALE
PCD 9	9512-1-0-41	9512-6-0-41
PCD 15	9512-2-0-41	9512-7-0-41
PCD 25	9512-3-0-41	9512-8-0-41
PCD 37	9512-4-0-41	9512-9-0-41
PCD 50	9512-5-0-41	9512-10-0-41
PCDD 15	9512-1-0-41	9512-11-0-41
PCDD 26	9512-2-0-41	9512-12-0-41
PCDD 44	9512-3-0-41	9512-13-0-41
PCDD 62	9512-4-0-41	9512-14-0-41
PCDD 78	9512-5-0-41	9512-15-0-41
PCDD 104	9512-16-0-41	9512-17-0-41
Arbor press for connector seating tools-9530-1-0      1 ton capacity      4 inch throat		
PCD series - Replacement pins for connector seating tools.		Female - 855-658-0-41
PCDD series - Replacement pins for connector seating tools.		Female - 855-751-0-41



**SUGGESTED PRINTED BOARD HOLE SIZES FOR COMPLIANT PRESS-FIT TERMINATION**

Traditionally, tin-lead has been a popular plating for printed circuit board (PCB) holes. However, many PCB hole platings must now be RoHS compliant. Positronic is pleased to offer **PCB HOLE SIZE FOR RoHS** PCB plating as shown below.

OMEGA COMPLIANT PRESS-FIT CONTACT HOLE				
BOARD TYPE	CONTACT SIZE / TYPE	RECOMMENDED DRILL HOLE SIZE	RECOMMENDED PLATING	FINISHED HOLE SIZES
TIN-LEAD SOLDER PCB	22 OMEGA	$\phi 0.0453 \pm 0.0010$ [ $\phi 1.150 \pm 0.025$ ]	0.0006 [15 $\mu$ ] minimum solder over 0.0010 [25 $\mu$ ] min. copper	$\phi 0.0394 + 0.0035 - 0.0024$ [ $\phi 1.000 + 0.090 - 0.060$ ]
	20 OMEGA	$\phi 0.0453 \pm 0.0010$ [ $\phi 1.150 \pm 0.025$ ]		$\phi 0.0394 + 0.0035 - 0.0024$ [ $\phi 1.000 + 0.090 - 0.060$ ]
RoHS PCB PLATING OPTIONS				
COPPER PCB	22 OMEGA	$\phi 0.047 \pm 0.001$ [ $\phi 1.19 \pm 0.025$ ]	0.0010 [25 $\mu$ ] min. copper	$\phi 0.043 \pm 0.002$ [ $\phi 1.09 \pm 0.05$ ]
	20 OMEGA	$\phi 0.047 \pm 0.001$ [ $\phi 1.19 \pm 0.025$ ]		$\phi 0.043 \pm 0.002$ [ $\phi 1.09 \pm 0.05$ ]
IMMERSION TIN PCB	22 OMEGA	$\phi 0.047 \pm 0.001$ [ $\phi 1.19 \pm 0.025$ ]	0.000033 $\pm$ 0.000006 [0.85 $\pm$ 0.15 $\mu$ ] immersion tin over 0.0010 [25 $\mu$ ] min. copper	$\phi 0.043 \pm 0.002$ [ $\phi 1.09 \pm 0.05$ ]
	20 OMEGA	$\phi 0.047 \pm 0.001$ [ $\phi 1.19 \pm 0.025$ ]		$\phi 0.043 \pm 0.002$ [ $\phi 1.09 \pm 0.05$ ]
IMMERSION SILVER PCB	22 OMEGA	$\phi 0.047 \pm 0.001$ [ $\phi 1.19 \pm 0.025$ ]	0.000013 $\pm$ 0.000007 [0.34 $\pm$ 0.17 $\mu$ ] immersion silver over 0.0010 [25 $\mu$ ] min. copper	$\phi 0.043 \pm 0.002$ [ $\phi 1.09 \pm 0.05$ ]
	20 OMEGA	$\phi 0.047 \pm 0.001$ [ $\phi 1.19 \pm 0.025$ ]		$\phi 0.043 \pm 0.002$ [ $\phi 1.09 \pm 0.05$ ]
ELECTROLESS NICKEL / IMMERSION GOLD PCB	22 OMEGA	$\phi 0.047 \pm 0.001$ [ $\phi 1.19 \pm 0.025$ ]	0.000002 [0.05 $\mu$ ] min. immersion gold over 0.000177 $\pm$ 0.000059 [4.5 $\pm$ 1.5 $\mu$ ] electroless nickel per IPC-4552 over 0.0010 [25 $\mu$ ] min. copper	$\phi 0.043 \pm 0.002$ [ $\phi 1.09 \pm 0.05$ ]
	20 OMEGA	$\phi 0.047 \pm 0.001$ [ $\phi 1.19 \pm 0.025$ ]		$\phi 0.043 \pm 0.002$ [ $\phi 1.09 \pm 0.05$ ]

**“Omega” Termination**

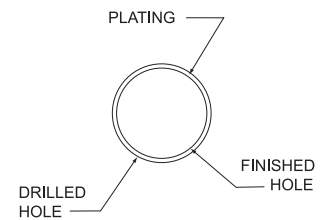

**COMPLIANT PRESS-FIT TERMINATION CONTACT HOLE**

**NOTE:** For PCB plating compositions not shown, consult Technical Sales.

**COMPLIANT PRESS-FIT USER INFORMATION**

When properly used, Positronic Omega signal compliant press-fit terminations provide reliable service even under severe conditions.

**Connectors utilizing this leading technology compliant press-fit contact are easy to install:**

1. Inexpensive installation tooling is available from Positronic, to choose the proper installation tool refer to page 83 for part number ordering information.
2. Insert the connector into the printed circuit board or backplane and seat connector fully.
3. Secure the connector to the printed circuit board or backplane using two self-tapping screws. The screws should be 4-40 threads supplied by customer.





# Positronic® offers a variety of QPL connector products

## D-SUBMINIATURE CONNECTORS

MIL PREFIX	POSITRONIC SERIES
MIL-DTL-24308/1	HDC
MIL-DTL-24308/2	RD, DD
MIL-DTL-24308/3	HDC
MIL-DTL-24308/4	RD, DD
MIL-DTL-24308/5	HDC
MIL-DTL-24308/6	RD, DD
MIL-DTL-24308/7	HDC
MIL-DTL-24308/8	RD, DD
MIL-DTL-24308/23	HDC, DD

MIL PREFIX	POSITRONIC SERIES
MIL-DTL-24308/24	HDC, DD
MIL-DTL-24308/25	HDC, RD, DD
MIL-DTL-24308/26	HDC, RD, DD
GSFC S-311-P4	SND, SDD, SCBC, SCBM
GSFC S-311-P10	SND, SCBM
SAE AS39029/57	DD
SAE AS39029/58	DD
SAE AS39029/63	RD
SAE AS39029/64	RD

## RECTANGULAR CONNECTORS

MIL PREFIX	POSITRONIC SERIES
MIL-DTL-28748/3	GMCT
MIL-DTL-28748/4	GMCT
MIL-DTL-28748/5	GM
MIL-DTL-28748/6	GM
MIL-DTL-28748/7	SGM

MIL PREFIX	POSITRONIC SERIES
MIL-DTL-28748/8	SGM
MIL-C-28748/13	SGMC
MIL-C-28748/14	SGMC
SAE AS39029/34	SGMC, GMCT
SAE AS39029/35	SGMC, GMCT

For a complete QPL listing available to download in PDF format, visit the desired connector family home page and click on link "Qualified Product Listing (PDF)" on our website at:

[www.connectpositronic.com](http://www.connectpositronic.com)

or enter the URL link below to download the QPL PDF file

[www.connectpositronic.com/qpl/catalog](http://www.connectpositronic.com/qpl/catalog)

# Other D-subminiature Products

Positronic offers full line of D-subminiature connectors in a wide variety of contact variants and package sizes with compliant press-fit, solder and cable terminations. All Positronic connector products provide quality, reliability, and flexibility.



## HIGH PERFORMANCE D-SUBMINIATURE CONNECTORS

Standard and high density connectors manufactured to MIL-PRF-24308, Class M; Goddard Space Flight Center S-311-P-4 and Goddard Space Flight Center S-311-P-10.

## ENVIRONMENTAL-D CONNECTORS

Standard and high density connectors with environmental protection features to IP67. Straight and right angle (90°), and cable terminations available.

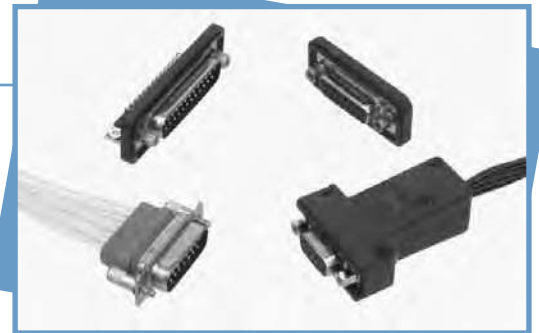

## COMBO-D CONNECTORS

Connectors with signal, shielded, power, thermocouple or high voltage contacts in a single package. Power compliant press-fit terminations now available.

## DUAL PORT CONNECTORS

Right angle (90°) p.c. board mount connectors assembled stacked to maximize real estate; contact variants 9 through 62; available in standard density, high density, and mixed density.

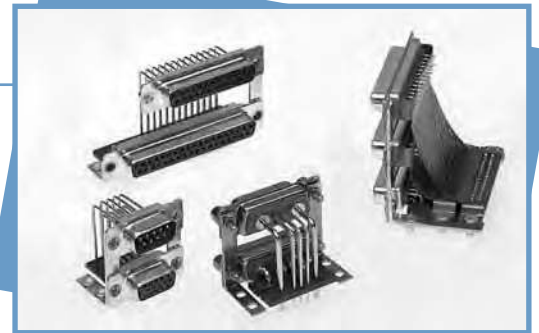

# Connector Excellence<sup>®</sup>

## Positronic HIGH RELIABILITY Products

### POWER



#### FEATURES:

- High current density
- Energy saving - low contact resistance
- AC/DC operation in a single connector
- Signal contacts for hardware management
- Blind mating
- Sequential mating
- Large surface area contact mating system
- Wide variety of accessories
- Customer-specified contact arrangements
- Modular tooling which produces a single piece connector insert

**Contact Sizes:** 0, 8, 12, 16, 20, 22 and 24  
**Current Ratings:** To 200 amperes per contact  
**Terminations:** Crimp and fixed cable connector, straight solder, right angle (90°) solder, straight compliant press-in and right angle (90°) compliant press-in  
**Configurations:** Multiple variants in a variety of package sizes  
**Compliance:** PICMG 2.11, PICMG 3.0, VITA 41, DSCC, GSFC S-311-P-4, GSFC S-311-P-10

### D - SUB MINIATURE



#### FEATURES:

- Four performance levels available for best cost/performance ratio: professional, industrial, military and space-flight quality
- Options include high voltage, coax, thermocouple and air coupling contacts; environmentally sealed and dual port connector packages including mixed density
- Broad selection of accessories
- Size 20 and 22 contacts suitable for use in carrying power
- IP65, IP67

**Contact Sizes:** 8, 16, 20 and 22  
**Current Ratings:** To 100 amperes  
**Terminations:** Crimp, wire solder, straight solder, right angle (90°) solder, straight compliant press-in and right angle (90°) compliant press-in  
**Configurations:** Multiple variants in both standard and high densities, seven connector housing sizes  
**Qualifications:** MIL-DTL-24308, GSFC S-311-P-4, GSFC S-311-P-10, SAE AS39029, DSCC

### RECTANGULAR



#### FEATURES:

- Two performance levels available: industrial quality and military quality
- A wide variety of accessories
- Broad selection of contact arrangement and package sizes
- Connector coding device (keying) options

**Contact Sizes:** 16, 20 and 22  
**Current Ratings:** To 13 amperes nominal  
**Terminations:** Crimp, wire solder, straight solder, right angle (90°) solder, and straight compliant press-in  
**Configurations:** Multiple variants in both standard and high densities, thirty package sizes  
**Qualifications:** MIL-DTL-28748, SAE AS39029, CCITT V,35

### CIRCULAR



#### FEATURES:

- Non-corrodible / lightweight composite construction
- EMI/RFI shielded versions
- Thermocouple contacts
- Environmentally sealed versions
- Rear insertion/ front release of removable contacts
- Two level sequential mating
- Overmolding available on full assemblies

**Contact Sizes:** 12, 16, 20 and 22  
**Current Ratings:** To 25 amperes nominal  
**Terminations:** Crimp, wire solder, straight solder, and right angle (90°) solder  
**Configurations:** Multiple variants in four package sizes  
**Qualifications:** Environmental protection to IP67

### CABLE



#### FEATURES:

- Shorten the supply chain and reduce additional costs and delays by "cabling" your Positronic connector selection
- Overmolding available
- Shielded and environmentally sealed versions available
- Power cables and access boxes which meet the SAE J2496 specification

- ✓ Design assemblies in accordance with customer specifications.
- ✓ Prepare wire harness connector configuration and performance specifications.
- ✓ Design each system in accordance with applicable customer, domestic, and international standards.
- ✓ Define and conduct performance and verification testing.

### HERMETIC



#### FEATURES:

- Intended for use as an electrical feedthrough in high vacuum applications
- Helium leakage rate at ambient temperature:  $< 5 \times 10^{-9}$  mbar.l/s under a vacuum  $1.5 \times 10^{-2}$  mbar
- Signal, power, coax and high voltage versions available
- Connectors can be mounted on flange assembly per customer specification

**Contact Sizes:** 8, 12, 16, 20 and 22  
**Current Ratings:** To 40 amperes nominal  
**Terminations:** Feedthrough is standard; flying leads and board mount available upon request  
**Configurations:** See D-subminiature and circular configurations above  
**Compliance:** Space-D32

For more information, visit [www.connectpositronic.com](http://www.connectpositronic.com) or call your nearest Positronic sales office listed on the back of this catalog.



**Positronic**<sup>®</sup>  
global connector solutions

### Regional Headquarters

#### Positronic | Americas

423 N Campbell Ave  
Springfield MO 65806 USA

+1 800 641 4054  
info@connectpositronic.com

#### Positronic | Europe

Z.I. d'Engachies  
46, route d'Engachies  
F-32020 Auch Cedex 9 France

+33 5 6263 4491  
contact@connectpositronic.com

#### Positronic | Asia

3014A Ubi RD 1 #07-01  
Singapore 408703

+65 6842 1419  
singapore@connectpositronic.com

#### Sales Offices

Positronic has local sales representation all over the world. To find the nearest sales office, please visit [www.connectpositronic.com/locations](http://www.connectpositronic.com/locations)

LOCATIONS  
For most current sales office information, please visit [www.connectpositronic.com/locations](http://www.connectpositronic.com/locations)

[www.connectpositronic.com](http://www.connectpositronic.com)