



# ORIENT DISPLAY

Your Total LCD Solution Provider

## Specification for TFT

**ACN480272A01-4.3N12NSM-R**

Revision 03



A	Orient Display
CN	Embedded Display
480272	Resolution 480 x 272
A01	Serial A01
4.3	4.3", Module Dimension 105.5 x 67.2 x 7.55 mm
N	TN Display
12	12 o'clock
N	Top: -30~+70°C; Tstr: -30~+80°C
S	Standard Configuration
M	Medium Brightness, 260cd/m2
R	Resistive Touch Panel
/	Controller <a href="#">SSD1963</a>
/	Parallel Interface



# CONTENTS

1.DISPLAY CHARACTERISTICS .....	3
2.Pin Description: TFT (SSD1963 output to TFT) .....	3
3.Pin Description: IN (SSD1963 input from user's MPU) .....	4
4.Electrical Characteristics .....	4
5.Controller Information ( Built - in SSD1963 ) .....	5
6. Pixel Data Format.....	7
7.Reliability Test Conditions .....	8
8. INSPECTION CRITERION .....	9
9. HANDLING PRECAUTIONS.....	16
10. PRECAUTION FOR USE .....	17
11. PACKING SPECIFICATION .....	17
12.Mechanical Drawing (Unit mm, Un-tolerated $\pm 0.3\text{mm}$ ).....	18

DATE	DESCRIPTION
2018-8-9	First release
2018-8-14	Modified the ZIF dimension
2018-10-19	Add the inspection criterion etc. and modified the electrical characteristics/Mechanical Drawing
2020-1-9	Update the 3.Pin Description

# 1.DISPLAY CHARACTERISTICS

Item	Contents	Note
<b>4.3 inch TFT LCM</b>		
Color	16.7M colors	24bit Palette 8R8G8B
Active area (L*W)	95.04 mm(L)×53.85 mm(W)	
viewing area (L*W)	98.7 mm(L)×57.5 mm(W)	
Resolution(H*V)	480×272 Pixels	
Back light type	LED	
B/L brightness	260nit	
Touch Panel Type	4-wire RTP	
Controller IC	SSD1963	

## 2.Pin Description: TFT (SSD1963 output to TFT)

Pin No.	Symbol	External Connection	Function Description
1	LED-	LED Power Supply	Backlight GND
2	LED+	LED Power Supply	Backlight Power
3	GND	Power Supply	GND
4	VCC	Power Supply	Power supply for LCD and logic
5-12	[R0-R7]	MPU	Red Data Signals
13-20	[G0-G7]	MPU	Green Data Signals
21-28	[B0-B7]	MPU	Blue Data Signals
29	GND	Power Supply	GND
30	PCLK	MPU	Data sample Clock signal
31	DISP	MPU	Display ON/OFF signal
32	HSYNC	MPU	Line synchronization signal
33	VSYNC	MPU	Frame synchronization signal
34	DE	MPU	Data Enable signal
35	ORIENTDISPLAYD	Power Supply	No Connect
36	GND	Power Supply	GND
37	XR	Touch Panel MPU	Touch Panel RIGHT
38	YD	Touch Panel MPU	Touch Panel DOWN
39	XL	Touch Panel MPU	Touch Panel LEFT
40	YU	Touch Panel MPU	Touch Panel UP

### 3.Pin Description: IN (SSD1963 input from user's MPU)

Pin No.	Symbol	External Connection	Function Description
1	GND	Power Supply	GND
2	VCC	Power Supply	Power supply for LCD and logic (3.3V)
3	B/L Enable	MPU	If open 1R4, the diming of backlight can controlled by user MCU(1=On, 0=Off) If short 1R4,resistor,the diming of backlight can controlled by SSD1963. Power on , default the backlight turn on.
4	RS	MPU	Register Select. RS=0: Command, RS=1: Data
5	R/W(WR#)	MPU	6800 mode: R/W 0: Write cycle 1: Read cycle 8080 mode: WR# (write strobe signal)
6	E(RD#)	MPU	6800 mode: E (enable signal) 8080 mode: RD# (read strobe signal)
7-14	DB0-DB7	MPU	8-bit bidirectional data bus
15	CS	MPU	Active LOW Chip Select signal
16	RST	MPU	Active LOW Reset signal
17	CONF	MPU	configured as 6800 mode or 8080 mode, 0=6800, 1=8080
18	XR	Touch Panel MPU	Touch Panel RIGHT
19	DISP	MPU	Display On signal
20	YD	Touch Panel MPU	Touch Panel DOWN
21	XL	Touch Panel MPU	Touch Panel LEFT
22	YU	Touch Panel MPU	Touch Panel UP

### 4.Electrical Characteristics

Item	Symbol	Condition	Min.	Typ.	Max.	Unit
Operating Temperature Range	Top	Absolute Max	-20	-	+70	°C
Storage Temperature Range	Tst	Absolute Max	-30	-	+80	°C
Supply Voltage	VDD		3.0	3.3	3.6	V
Input High Voltage	VIH		0.8*VDD	-	VDD	V
Input Low Voltage	VIL		0	-	0.2*VDD	V
Supply Current	IVCI		-	253	-	mA
Power Consumption	PLCM		-	835	-	mW

## 5. Controller Information ( Built-in SSD1963 )

### 5.1.1 Parallel 6800-series Interface Timing Characteristics

Symbol	Parameter	Min	Typ	Max	Unit
$f_{MCLK}$	System Clock Frequency*	1	-	110	MHz
$t_{MCLK}$	System Clock Period*	$1/f_{MCLK}$	-	-	ns
$t_{PWCSH}$	Control Pulse Low Width	Write (next write cycle)	13	$1.5 * t_{MCLK}$	ns
		Write (next read cycle)	80	$9 * t_{MCLK}$	
		Read	80	$9 * t_{MCLK}$	
$t_{PWCSL}$	Control Pulse High Width	Write	13	$1.5 * t_{MCLK}$	ns
		Read	30	$3.5 * t_{MCLK}$	
$t_{AS}$	Address Setup Time	2	-	-	ns
$t_{AH}$	Address Hold Time	2	-	-	ns
$t_{DSW}$	Data Setup Time	4	-	-	ns
$t_{DHW}$	Data Hold Time	1	-	-	ns
$t_{PLW}$	Write Low Time	14	-	-	ns
$t_{PHW}$	Write High Time	14	-	-	ns
$t_{PLWR}$	Read Low Time	38	-	-	ns
$t_{ACC}$	Data Access Time	32	-	-	ns
$t_{DHR}$	Output Hold time	1	-	-	ns
$t_R$	Rise Time	-	-	0.5	ns
$t_F$	Fall Time	-	-	0.5	ns

\* System Clock denotes external input clock (PLL-bypass) or internal generated clock (PLL-enabled)

### 5.1.2 Parallel 6800-series Interface Timing Diagram

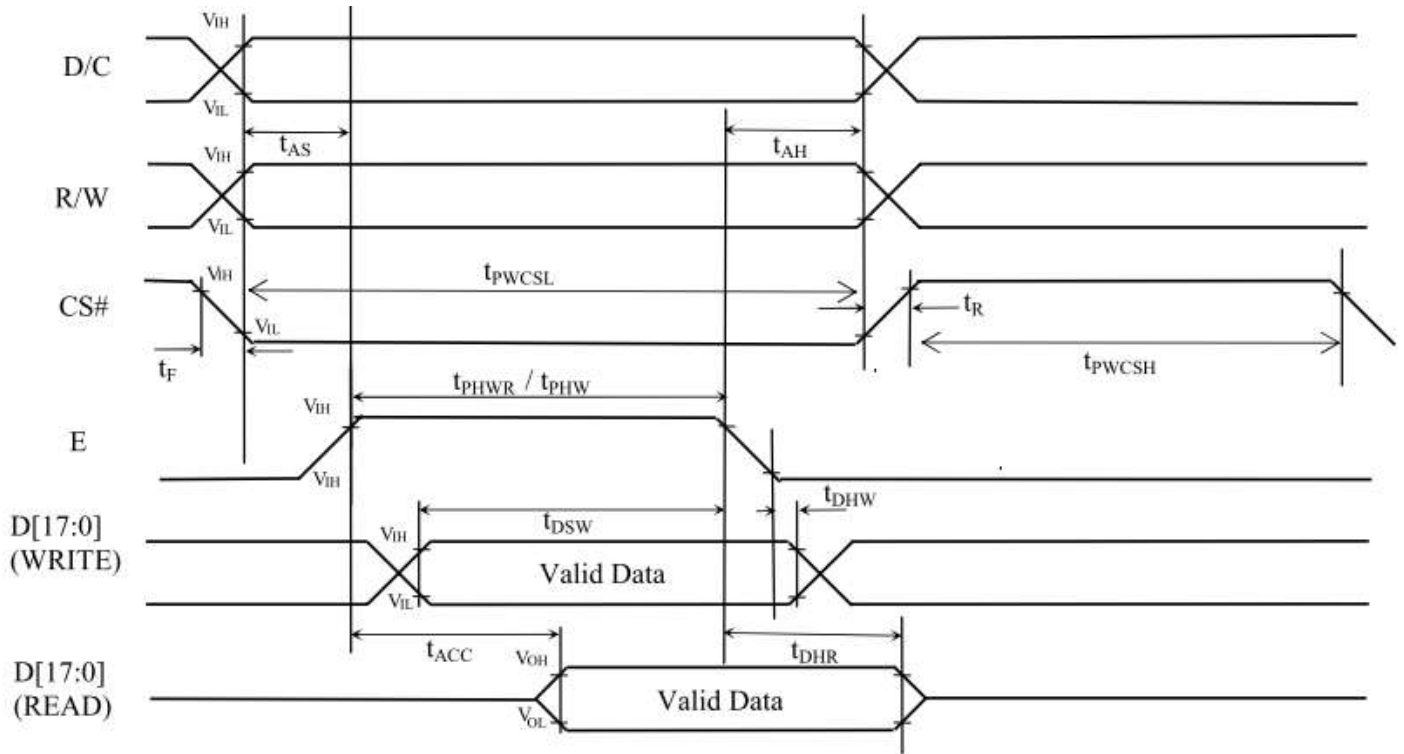

### 5.2.1 Parallel 8080-series Interface Timing Characteristics

Symbol	Parameter	Min	Typ	Max	Unit
$f_{MCLK}$	System Clock Frequency*	1	-	110	MHz
$t_{MCLK}$	System Clock Period*	$1/f_{MCLK}$	-	-	ns
$t_{PWCSL}$	Control Pulse High Width Write	13	$1.5 * t_{MCLK}$	-	ns
	Control Pulse High Width Read	30	$3.5 * t_{MCLK}$	-	ns
$t_{PWCSH}$	Control Pulse Low Width Write (next write cycle)	13	$1.5 * t_{MCLK}$	-	ns
	Control Pulse Low Width Write (next read cycle)	80	$9 * t_{MCLK}$	-	ns
	Control Pulse Low Width Read	80	$9 * t_{MCLK}$	-	ns
$t_{AS}$	Address Setup Time	1	-	-	ns
$t_{AH}$	Address Hold Time	2	-	-	ns
$t_{DSW}$	Write Data Setup Time	4	-	-	ns
$t_{DHW}$	Write Data Hold Time	1	-	-	ns
$t_{PWLW}$	Write Low Time	12	-	-	ns
$t_{DHR}$	Read Data Hold Time	1	-	-	ns
$t_{ACC}$	Access Time	32	-	-	ns
$t_{PWLR}$	Read Low Time	36	-	-	ns
$t_R$	Rise Time	-	-	0.5	ns
$t_F$	Fall Time	-	-	0.5	ns
$t_{CS}$	Chip select setup time	2	-	-	ns
$t_{CSH}$	Chip select hold time to read signal	3	-	-	ns

\* System Clock denotes external input clock (PLL-bypass) or internal generated clock (PLL-enabled)

### 5.2.2 Parallel 8080-series Interface Timing Diagram (Write Cycle)

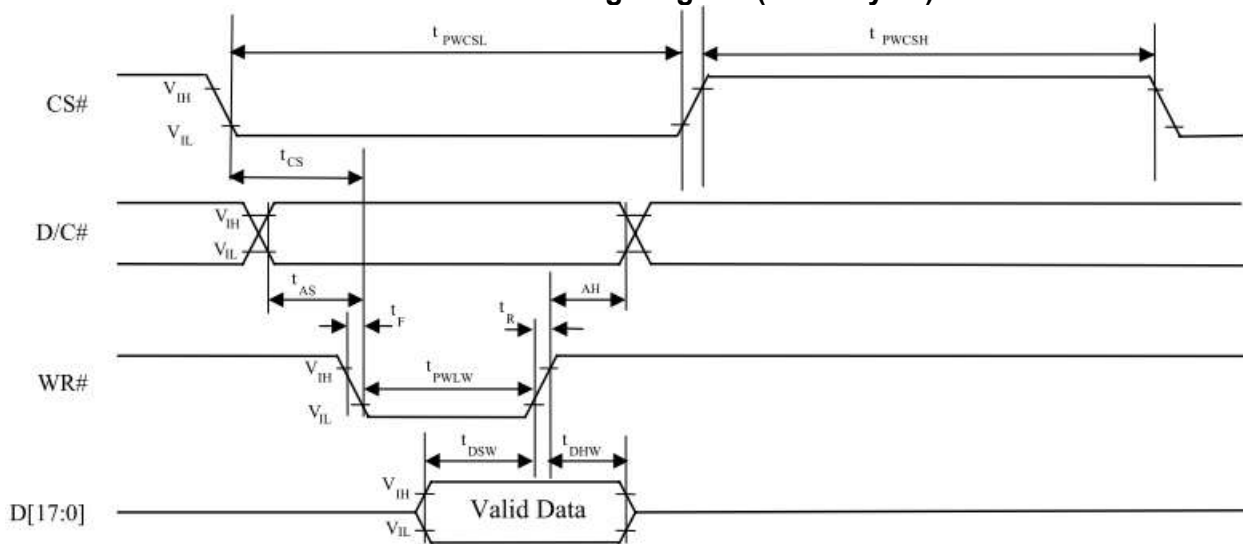

### 1.2.3 Parallel 8080-series Interface Timing Diagram (Read Cycle)

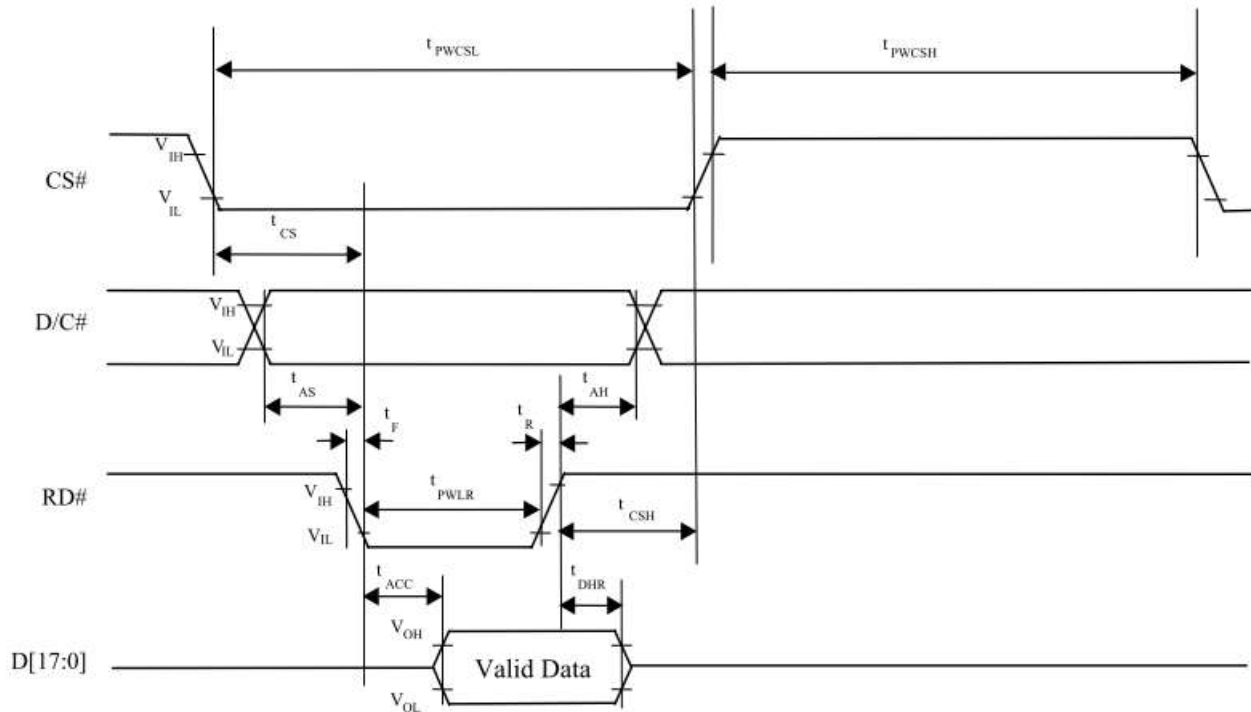

## 6. Pixel Data Format

Both 6800 and 8080 support 8-bit, 9-bit, 16-bit, 18-bit and 24-bit data bus. Depending on the width of the data bus, the display data are packed into the data bus in different ways.

Interface	Cycle	D[23]	D[22]	D[21]	D[20]	D[19]	D[18]	D[17]	D[16]	D[15]	D[14]	D[13]	D[12]	D[11]	D[10]	D[9]	D[8]	D[7]	D[6]	D[5]	D[4]	D[3]	D[2]	D[1]	D[0]	
24 bits	1 <sup>st</sup>	R7	R6	R5	R4	R3	R2	R1	R0	G7	G6	G5	G4	G3	G2	G1	G0	B7	B6	B5	B4	B3	B2	B1	B0	
18 bits	1 <sup>st</sup>							R5	R4	R3	R2	R1	R0	G5	G4	G3	G2	G1	G0	B5	B4	B3	B2	B1	B0	
16 bits (565 format)	1 <sup>st</sup>									R5	R4	R3	R2	R1	G5	G4	G3	G2	G1	G0	B5	B4	B3	B2	B1	
16 bits	1 <sup>st</sup>									R7	R6	R5	R4	R3	R2	R1	R0	G7	G6	G5	G4	G3	G2	G1	G0	
	2 <sup>nd</sup>									B7	B6	B5	B4	B3	B2	B1	B0	R7	R6	R5	R4	R3	R2	R1	R0	
	3 <sup>rd</sup>									G7	G6	G5	G4	G3	G2	G1	G0	B7	B6	B5	B4	B3	B2	B1	B0	
12 bits	1 <sup>st</sup>														R7	R6	R5	R4	R3	R2	R1	R0	G7	G6	G5	G4
	2 <sup>nd</sup>													G3	G2	G1	G0	B7	B6	B5	B4	B3	B2	B1	B0	
9 bits	1 <sup>st</sup>																R5	R4	R3	R2	R1	R0	G5	G4	G3	
	2 <sup>nd</sup>																G2	G1	G0	B5	B4	B3	B2	B1	B0	
8 bits	1 <sup>st</sup>																	R7	R6	R5	R4	R3	R2	R1	R0	
	2 <sup>nd</sup>																	G7	G6	G5	G4	G3	G2	G1	G0	
	3 <sup>rd</sup>																	B7	B6	B5	B4	B3	B2	B1	B0	

## 7. Reliability Test Conditions

No.	Test item	Test condition	Inspection after test
11.1	High temperature storage	80±2°C/120 hours	Note 1,2
11.2	Low temperature storage	-30±2°C/120 hours	
11.3	High temperature operating	70±2°C/120 hours	
11.4	Low temperature operating	-20±2°C/120 hours	
11.5	Temperature cycle	-20±2°C~25°C~70±2°C*10cycles (30min.) (5min.) (30min.)	
11.6	Damp proof test	60°C*90% RH/96 hours	
11.7	Vibration test	Frequency : 10Hz~55Hz~10Hz Amplitude : 1.5mm , X , Y , Z direction for total 3hours (Packing condition)	
11.8	Dropping test	Drop to the ground from 1m height, one time, every side of carton. (Packing condition)	
11.9	ESD test	Voltage : ±800V R : 330Ω C : 150pF Air discharge, 1 time	
Remark : Note 1: No condensation to be observed. Note 2: Conducted after 4 hours of storage at 25°C, 0%RH.			



## 8. INSPECTION CRITERION

### 8.1 Objective

The TFT test criterion are set to formalize TFT quality standards for ORIENTDISPLAY with reference to those of the customer for inspection, release and acceptance of finished TFT products in order to guarantee the quality of TFT products required by the customer.

### 8.2. Scope

The criterion is applicable to all the TFT products manufactured by ORIENTDISPLAY.

### 8.3. Equipment for Inspection

Electrical tester, electrical testing machines, vernier calipers, microscopes, magnifiers, anti-static wrist straps, finger cots, labels, tri-phase cold and hot shock machine, constant temperature and humidity chamber, backlight table, ovens for high-low temperature experiments, refrigerators, constant voltage power supply (DC), desk Lamps, etc.

### 8.4. Sampling Plan and Reference Standards

8.4.1 Sampling plan :

Refer to National Standard GB/T 2828.1---2012/ISO2859-1:1999, level II of normal levels :

**Major defect: AQL 0.4**

**Minor defect: AQL 1.0**

8.4.2 GB/T 2828.1---2012/ISO2859-1:1999 Sampling check procedure in count

8.4.3 GB/T 18910. Standard for LCM parts

8.4.4 GB/T24213-2008 Basic Environmental Test Procedures for Electrical and Electronic Products

8.4.5 IPC-A-610E Acceptability of Electronic Assemblies

### 8.5. Inspection Conditions and Inspection Reference

8.5.1 Cosmetic inspection: shall be done normally at  $23\pm 5^{\circ}\text{C}$  of the ambient temperature and 45~75%RH of relative humidity, under the ambient luminance between 500lux~1000lux and at the distance of 30cm apart between the inspector's eyes and the LCD panel and normally in reflected light. For backlight LCM, cosmetic inspection shall be done under the ambient luminance less than 100lux with the backlight on.

8.5.2 The TFT shall be tested at the angle of  $45^{\circ}$  left and right and  $0-45^{\circ}$  top and bottom as the following picture showing:

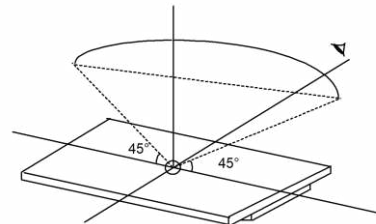
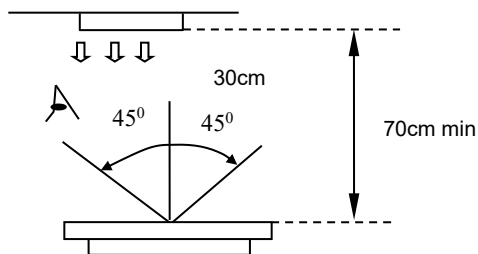

8.5.3 Definition of viewing area(VA)

A area : Active area(AA area)

B area : Viewing area(VA area)

C area : Non-viewing area(not viewing after customer assembly)

If there is any appearance viewing defect which do not affect product quality and customer assembly in C area, it's accepted in generally.

The criteria apply to A and B area except chipping and crack.

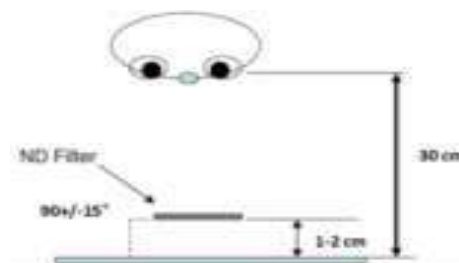
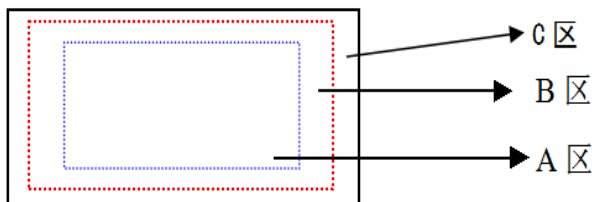

8.5.4 Inspection with naked eyes(exclusive of the inspection of the physical dimensions of defects carried out with magnifiers)

8.5.5 ND card use method(refer to right conner image) and scope: Multi-bright dot; Mura(Black/Gray pattern uneven); dark line and so on.

8.5.6 Undefined items or other special items, refer to mutual agreement and limited sample. If criterion does not match product specifications/ technical requirement, both should be subject to special inspection criterion agreed by customer.







## 8.6. Defects and Acceptance Standards

8.6.1 Electrical properties test

8.6.1.1 Test voltage(V) : Refer to the instruction of testers and the product specification or drawing and the display content and parameters and display effects shall conform to the product specification and drawing.

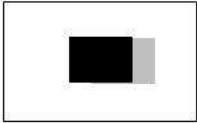
8.6.1.2 Current Consumption(I) : Refer to approved product specifications or drawings.

8.6.1.3 Function items(Defect category : MA.)

No.	Defects	Descriptions	Pictures	Inspection method/tools	Defect category
8.6.1.3.1	No display /reaction	shows no picture/display in normal connected situation.		Naked eyes/ testers	MA.
8.6.1.3.2	Missing segment	Shows missing lines in normal display		Naked eyes/ testers	MA.
8.6.1.3.3	Dark line	Only visible on gray pattern, 1 or more vertical/horizontal lines:5%ND,not visible,OK	/	Naked eyes/ testers	MA.
8.6.1.3.4	POL angle defect	Not accepted		Naked eyes/ testers	MA.
8.6.1.3.5	Image retention (sticking)	Chess pattern stays for 30mins and change to 50% gray pattern,disappear time <10s, OK; if time>10s, NG		Naked eyes/ testers	MA.
8.6.1.3.6	Flicker	Refer to limit sample if essential or flicker value<-30dB(measured by CA310A); OK		Naked eyes/ CA310A	MA.
8.6.1.3.7	Display abnormal	Not accepted		Naked eyes/ testers	MA.
8.6.1.3.8	Cross-talk	Refer to limited sample		Naked eyes/ limited sample	MA.
8.6.1.3.9	Display dim/bright	Refer to limited sample	/	Naked eyes/ limited sample	MA.
8.6.1.3.10	Contrast	Refer to limited sample	/	Naked eyes/ limited sample	MA.
8.6.1.3.11	Huge current	Out of spec, not accepted	/	Ammeter	MA.



8.6.1.3.12	TP function defect	Not accepted	/	Naked eyes/ Touch/ test program	MA.
------------	--------------------	--------------	---	---------------------------------------	-----

8.6.2 LCD dot/line defect

8.6.2.1 LCD pixel dot defect(defect category : MI.)

Item	Inspection criterion			
	Size	S<5"	5"≤S<10"	10"≤S<15"
Color pixel dot defect(RGB dot)		1	2	2
2 connected bright dot		0	1	1
3 connected bright dot or more		0	0	1
Bright dot quantity		1	2	3
Random dark dot quantity		2	3	4
2 connected dark dot		1	1	2
3 connected dark dot or more		0	0	0
Dark dot quantity		3	4	5
Multi-bright dot	ND 3%hidden, OK			
Remark: 2 bright dots distance DS≥15mm 2 dark dots distance DS≥5mm				
1) Bright dot: Power on TFT and RGB dot in black display				
2) Dark dot: Power on TFT and gray or black dot in RGB display				
3) Multi-bright dot: Power on TFT and fluorescent tiny dot in black display(only visible in black display)				

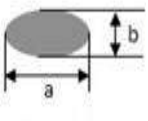
8.6.2.2 LCD appearance dot defect (defect category : MI.)

No.	Item	Inspection criterion				Picture	Inspection method/tools	
		Size	S<5"	5"≤S<10"	10"≤S<15"			
8.6.2.2.1	Dot defect (black dot, white dot)	D≤0.15	Not count	Not count	D≤0.2mm	 D=(a+b)/2	Naked eyes /film card /magnifier	
		0.15<D≤0.25	3	3	Not count			
		0.25<D≤0.30	1	2	0.2~0.35mm			
		0.30<D≤0.35	0	1	Q'ty ≤ 4			
		0.35<D≤0.50	0	0	1			
		D>0.5	0	0	0			
Remark : D≤0.15mm, not count.Multi-dot as bulk is not accepted. Count dot quantity≤ 5 2 round dots or linear dots in 1 cm is judged as multi-dot.								
8.6.2.2.2	Line defect (visible when power on)	Length (mm)	Width (mm)	S<5"	5"≤S<10"	10"≤S<15"		Naked eyes /film card /magnifier
		Not count	W≤0.03	Accepted	Accepted	Accepted		
		L≤5	0.03≤W<0.05	3	3	Not count		
		L≤5	0.05≤W<0.08	0	1	3		
		L≤8	0.05≤W<0.08	0	0	1		
		L>8	W>0.08	0				
Remark : Invisible when power on,only visible in special angle against light, show as watermark/folding/scratch but can not be touched, no control or refer to keeping sample.								

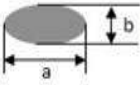
8.6.2.2.3	Polarizer convex-concave dot defect, polarizer bubble defect	Size(mm)	S<5"	5"≤S<10"	10"≤S<15"		Naked eyes /film card /magnifier
		D≤0.20	Not count	Not count	Not count		
		0.20<D≤0.5	2	2	3		
		0.50<D≤0.8	0	1			
		0.8<D≤1.5	0	0	1		
D>1.5mm	0	0	0				

8.6.3 Chipping defect

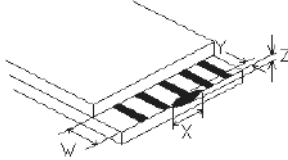
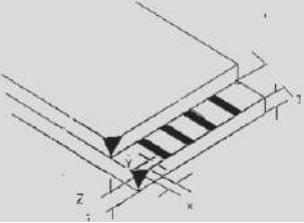
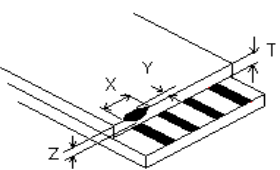
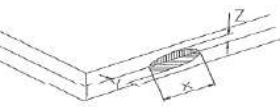
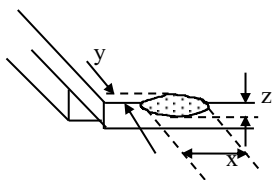
No.	Item	Accepted criterion(mm)				MA.	MI.
8.6.3.1	ITO conductive side 	X	/	≤1/8L	/		√
		Y	Y≤1/6W	1/6W <Y≤1/4W	1/4W <Y		
		Accept	2	2	0		
		Corner chipping occurred in sealed edge position as per 6.3.3; at the same time it should not enter into black border of the frame and the corner chipping effect the electric connection position perform as per 6.3.1.					
8.6.3.2	Corner chipping (ITO pins position) 	X	/	≤1/6L	/		√
		Y	Y≤1/2W	1/2W <Y≤W	W <Y		
		Accept	2	1	0		
		Corner chipping occurred in sealed edge position as per 6.3.3; at the same time it should not enter into black border of the frame and the corner chipping effect the electric connection position perform as per 6.3.1.					
8.6.3.3	Chipping in sealed area (outside chipping)   Chipping in sealed area (inside chipping) 	X	/	≤1/8L	/		√
		Y(outside chipping)	Not enter into sealant	Enter Y≤H	H<Y		
		Y(inside chipping)		Enter Y≤1/2H	1/2H<Y		
		Z	≤T	≤1/2T	/		
		Accept	2	1	0		
		The standards of inner and outer chipping on edge sealing area are same. When the chipping occurred in the opposite of stage, Y as per the chipping on the non-conduction side standard in 6.3.1					
8.6.3.4	Conductive side (back side chipping) 	X	/	≤1/6L	/		√
		Y	Y≤1/3W	1/3W <Y≤2/3W	2/3W <Y		
		Accept	2	2	0		
		Chipping into ITO side, refer to 6.3.1					

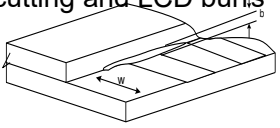
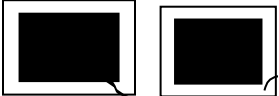
8.6.3.5		X	/	$\leq 1/8L$	/		√
		Y	$\leq 1/6W$	$1/6W < Y \leq 1/5W$	$1/5W < Y$		
		Z	/	/	/		
		Accept	1	1	1		
		The outside protruding control as per the tolerance of drawing.					
8.6.3.6		Not allow to occur cracks without direction; the crack expand to inside is NG, but to outside is OK (confirmed as per the damaged standard)					√

Remark :

X means the length of chipping;

Y means the width;

Z means the thickness;

W means the step width of the two glasses;

H means the distance from the glass edge to the sealant inner edge;

T means glass thickness.

#### 8.6.4 Backlight components

No.	Item	Description	Accepted criterion	MA.	MI.
8.6.4.1	No backlight wrong Color	/	Rejected	√	
8.6.4.2	Color deviation	When powered on, the LCD color differs from its sample and found that the color not conforming to the drawing after testing.	Refer to sample and drawing		√
8.6.4.3	Brightness deviation	When powered on, the LCD brightness differs from its sample and is found after testing not conforming to the drawing; or if it conforms to the drawing but the brightness over $\pm 40\%$ than its typical value.	Refer to sample and drawing		√
8.6.4.4	Uneven brightness	Uneven on the same LCD and out of the specification of the drawing. The no specification evenness= (the max value-the min value)/ mean value < 70%.	Refer to sample and drawing		√
8.6.4.5	Spot/line/scratch	When power on, it has dirty spot, scratches and so on spot and line defects.	Refer to 6.2.2		√

#### 8.6.5 Metal frame (Metal Bezel)



No.	Item	Description	Accepted criterion	MA.	MI.
8.6.5.1	Material & surface treatment	Metal frame/surface treatment do not conform to the specifications.	Rejected	√	
8.6.5.2	Tab twist Unconformity /Tab not twisted	Wrong twist method or direction and twist tabs are not twisted as required.	Rejected	√	

8.6.5.3	Bezel paint loss	1.Front surface : Paint peel off and scratch to the bottom Dot:D≤0.5mm, exceeds 3; Line:L≤3.0mm,W≤0.05mm exceeds 2; 2.Front dent, air bubble and side with paint peeling off scratch to the bottom Dot: D≤1.0mm, exceeds 3; Line:L≤3.0mm,W≤0.05mm, exceeds 2;	Rejected		√
8.6.5.4	Bezel scratch				√
8.6.5.5	Painting peel off, discoloration, dent, and scratch				√
8.6.5.6	Burr	Burr(s) on metal bezel is so long as to get into viewing area.	Rejected		√

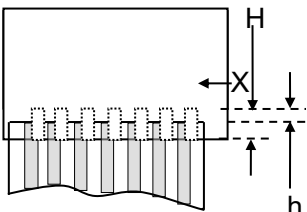
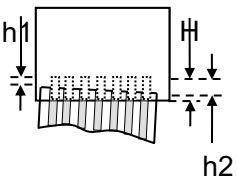
### 8.6.6 FPC

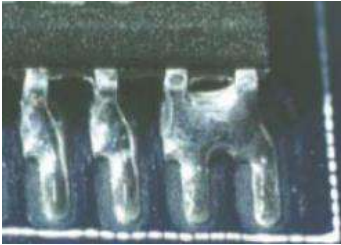

No.	Item	Description	Accepted criterion	MA.	MI.
8.6.6.1	Model &P/N	Material model & P/N	Keep the same with drawing and technical requirement	√	
8.6.6.2	Dimension/ position	<p>Dimension in drawing spec</p>  <p>Remark: H=ITO pin length f=FPC width W=ITO pin width</p>	<p><math>f \leq 1/3w</math>, <math>h \leq 1/3H</math>, dimension in drawing spec-&gt; OK Conductive material and ITO/PDA connective area must over than 1/2. Entire dimension must be in spec tolerance.</p> 		√
8.6.6.3	FPC appearance	Hot pressing material get broken, folding line open; FPC golden finger oxidate, broken ,scratch ,foreign material which cause line short	Broken length<2mm; FPC line is OK- > Accepted Crack and line broken->Rejected		√
8.6.6.4	FPC burr	Burr near FPC edge area	When cover line and burr length ≤1.0mm->Accepted		√
8.6.6.5	FPC falling off	FPC bonding area falling off ; silica gel breaking	Rejected		√
8.6.6.6	Sealant missing ITO line	Sealant is not covered all ITO line	Rejected	√	
8.6.6.7	Missing sealant	No sealant	Rejected	√	
8.6.6.8	Sealant	Sealant height ->product total height	Rejected	√	

8.6.7 SMT

No.	Item	Description	Accepted criterion	MA.	MI.
8.6.7.1	Soldering bridge	Solder between adjacent pads and components 	Rejected		√
8.6.7.2	Solder ball/splash	Solder ball/tin dross causing short circuit at the solder point. There are active solder ball and splash.	Rejected		√
8.6.7.3	Soldering excursion	Soldering slant > 1/3 soldering pad 	Rejected		√
8.6.7.4	Component wrong attaching	Component on PCB differs with drawing: wrong one, extra one, lack one, opposite polarity	Rejected	√	
		JUMP short circuit on PCB: extra soldering, lack soldering.	Rejected	√	
8.6.7.5	Component falling off	Soldering but component is missing	Rejected	√	
8.6.7.6	Wrong component	Component model/spec differs from product specification	Rejected	√	

8.6.8 General Appearance

No.	Item	Description	Accepted criterion	MA.	MI.
8.6.8.1	Dimension	According to drawing	Accepted	√	
8.6.8.2	Surface stain	Defect mark or label are not removed residual glue, and finger print, etc;	Rejected		√
8.6.8.3	Assembly foreign material	Dot/linear stain after assembly backlight and diffuse film TP assembly foggy stain	Invisible when power on->OK Refer to 6.2.2 dot/line spec		√
8.6.8.4	Mixture	Different model product in the same shipment	Rejected	√	
8.6.8.5	Product mark	Missing, unclear, incorrect, or misplaced part	Rejected		√
8.6.8.6	Component mark	Silk screen mark clear, resistance measured value in spec	Accepted (Refer to customer special requirement)		√
8.6.8.7	Newton's rings	Area < 1/6 screen area quantity ≤ 1	Accepted		√
8.6.8.8	Mura	1. In black display ND 3% invisible ->OK; visible->NG 2. Naked eyes inspection RGB display invisible Black display, area < 1/4 screen area 	Refer to limited sample		√

8.6.8.9	Light leak	<p>1.LCD edge(near backlight) shadow by LCD lamps irregular illuminate</p> <p>2.Judge in black/white/gray display (slight leaky is yellowish,greenish, blueish -&gt;NG);</p> <p>Tape 浮起漏光</p>  <p>Panel 側邊漏光</p> 	Refer to limited sample		√
8.6.8.10	Polarizer	<p>1.Polarizer slant.Cover VA and not over LCD edge</p> <p>2.No unmovable stain or finger print in polarizer VA</p> <p>3.Bubble/warped but not enter VA</p>	Accepted		√
8.6.8.11	TP defect	<p>1.TP crack</p> <p>2.TP stain(fogy&amp; unremovable)</p> <p>3.TP glue overflow to VA</p>	Rejected		√

Remark :

Anything which is not clearly defined in 6.5~6.8 should refer to IPC-A-610E.Consumer Electronics, Non-consumer Electronics refer to I grade and Industrial,Automobile refer to II grade.

## 8.7 Others

Items not specified in this document or released on compromise should be inspected with reference to mutual agreement and limit samples.

## 9. HANDLING PRECAUTIONS

### 9.1 Mounting method

The LCD module consists of two thin glass plates with polarizes which easily be damaged. And since the module in so constructed as to be fixed by utilizing fitting holes in the printed circuit board.

Extreme care should be needed when handling the LCD modules.

### 9.2 Caution of LCD handling and cleaning

When cleaning the display surface, Use soft cloth with solvent [recommended below] and wipe lightly :

- .Isopropyl alcohol
- .Ethyl alcohol

Do not wipe the display surface with dry or hard materials that will damage the polarizer surface.

Do not use the following solvent :

- .Water
- .Aromatics

Do not wipe ITO pad area with the dry or hard materials that will damage the ITO patterns

Do not use the following solvent on the pad or prevent it from being contaminated :

- .Soldering flux
- .Chlorine (Cl) , Sulfur (S)

If goods were sent without being silicon coated on the pad, ITO patterns could be damaged due to the corrosion as time goes on.

If ITO corrosion happen by miss-handling or using some materials such as Chlorine (Cl), Sulfur (S) from customer, Responsibility is on customer.



### 9.3 Caution against static charge

The LCD module use C-MOS LSI drivers, so we recommended that you :

Connect any unused input terminal to Vdd or Vss, do not input any signals before power is turned on, and ground your body, work/assembly areas, assembly equipment to protect against static electricity.

### 9.4 Packing

Module employ LCD elements and must be treated as such.

- .Avoid intense shock and falls from a height.
- .To prevent modules from degradation, do not operate or store them exposed direct to sunshine or high temperature/humidity.

### 9.5 Caution for operation

- .It is an indispensable condition to drive LCD's within the specified voltage limit since the higher voltage then the limit cause the shorter LCD life.
- .An electrochemical reaction due to direct current causes LCD's undesirable deterioration, so that the use of direct current drive should be avoided.
- .Response time will be extremely delayed at lower temperature then the operating temperature range and on the other hand at higher temperature LCD's how dark color in them. However those phenomena do not mean malfunction or out of order with LCD's, which will come back in the specified operation temperature.
- .If the display area is pushed hard during operation, some font will be abnormally displayed but it resumes normal condition after turning off once.
- .A slight dew depositing on terminals is a cause for electro-chemical reaction resulting in terminal open circuit.
- .Usage under the maximum operating temperature, 50%Rh or less is required.
- .When fixed patterns are displayed for a long time, remnant image is likely to occur.

### 9.6 Storage

In the case of storing for a long period of time for instance, for years for the purpose or replacement use, the following ways are recommended.

- .Storing in an ambient temperature 10°C to 30°C, and in a relative humidity of 45% to 75%. Don't expose to sunlight or fluorescent light.
- .Storing in a polyethylene bag with the opening sealed so as not to enter fresh air outside in it . And with no desiccant.
- .Placing in a dark place where neither exposure to direct sunlight nor light's keeping the storage temperature range.
- .Storing with no touch on polarizer surface by the anything else.

It is recommended to store them as they have been contained in the inner container at the time of delivery from us.

### 9.7 Safety

- .It is recommendable to crash damaged or unnecessary LCD's into pieces and wash off liquid crystal by either of solvents such as acetone and ethanol, which should be burned up later.
- .When any liquid leaked out of a damaged glass cell comes in contact with your hands, please wash it off well with soap and water.

## 10. PRECAUTION FOR USE

**10.1** A limit sample should be provided by the both parties on an occasion when the both parties agreed its necessity. Judgment by a limit sample shall take effect after the limit sample has been established and confirmed by the both parties.

**10.2** On the following occasions, the handing of problem should be decided through discussion and agreement between responsible of the both parties.

- .When a question is arisen in this specification.
- .When a new problem is arisen which is not specified in this specifications.
- .When an inspection specifications change or operating condition change in customer is reported to ORIENTDISPLAY, and some problem is arisen in this specification due to the change.
- .When a new problem is arisen at the customer's operating set for sample evaluation in the customer site.

## 11. PACKING SPECIFICATION

---TBD

# 12.Mechanical Drawing (Unit mm, Un-tolerated ±0.3mm)

