

400012662

POSITION OF COLOUR STRIPE (see note 3)

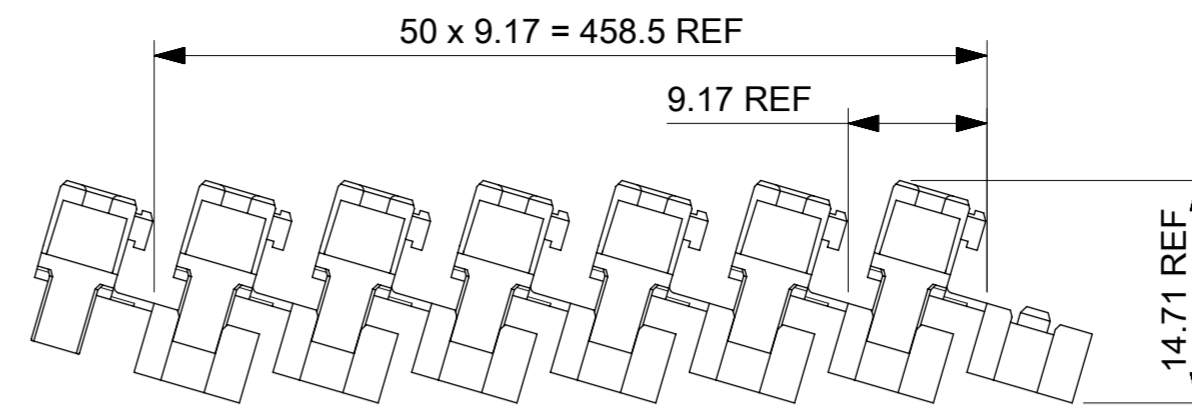
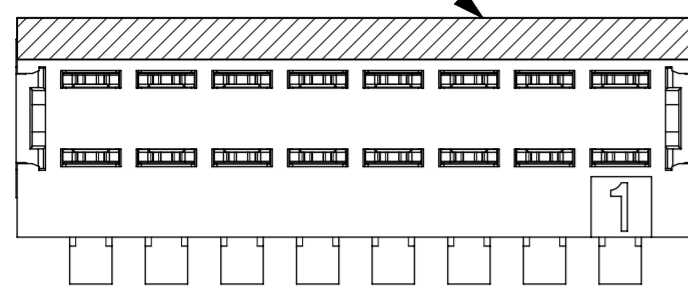

SHIPPING ARRANGEMENT

CCT	A	B
3	5.0	9.875
4	7.5	12.375
5	10.0	14.875
6	12.5	17.375
7	15.0	19.875
8	17.5	22.375
9	20.0	24.875
10	22.5	27.375
11	25.0	29.875
12	27.5	32.375
13	30.0	34.875
14	32.5	37.375
15	35.0	39.875
16	37.5	42.375
17	40.0	44.875
18	42.5	47.375
19	45.0	49.875
20	47.5	52.375

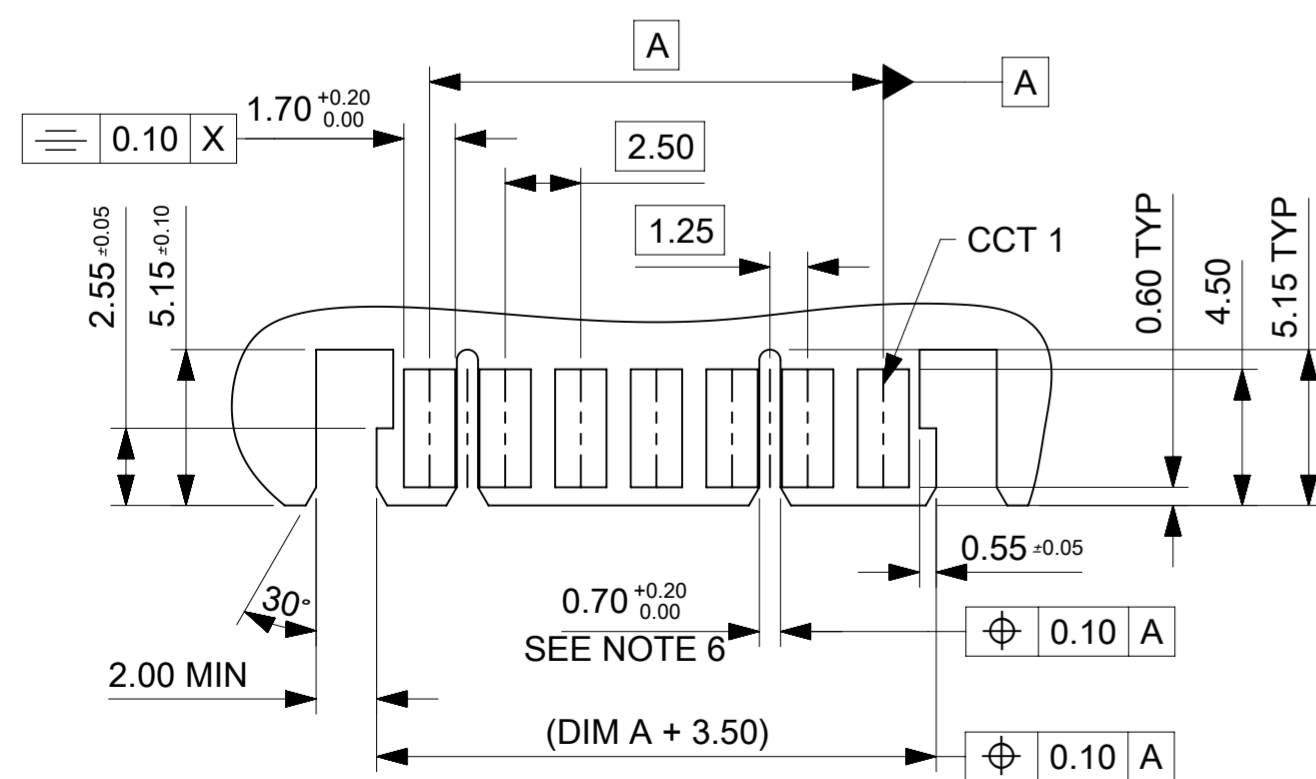
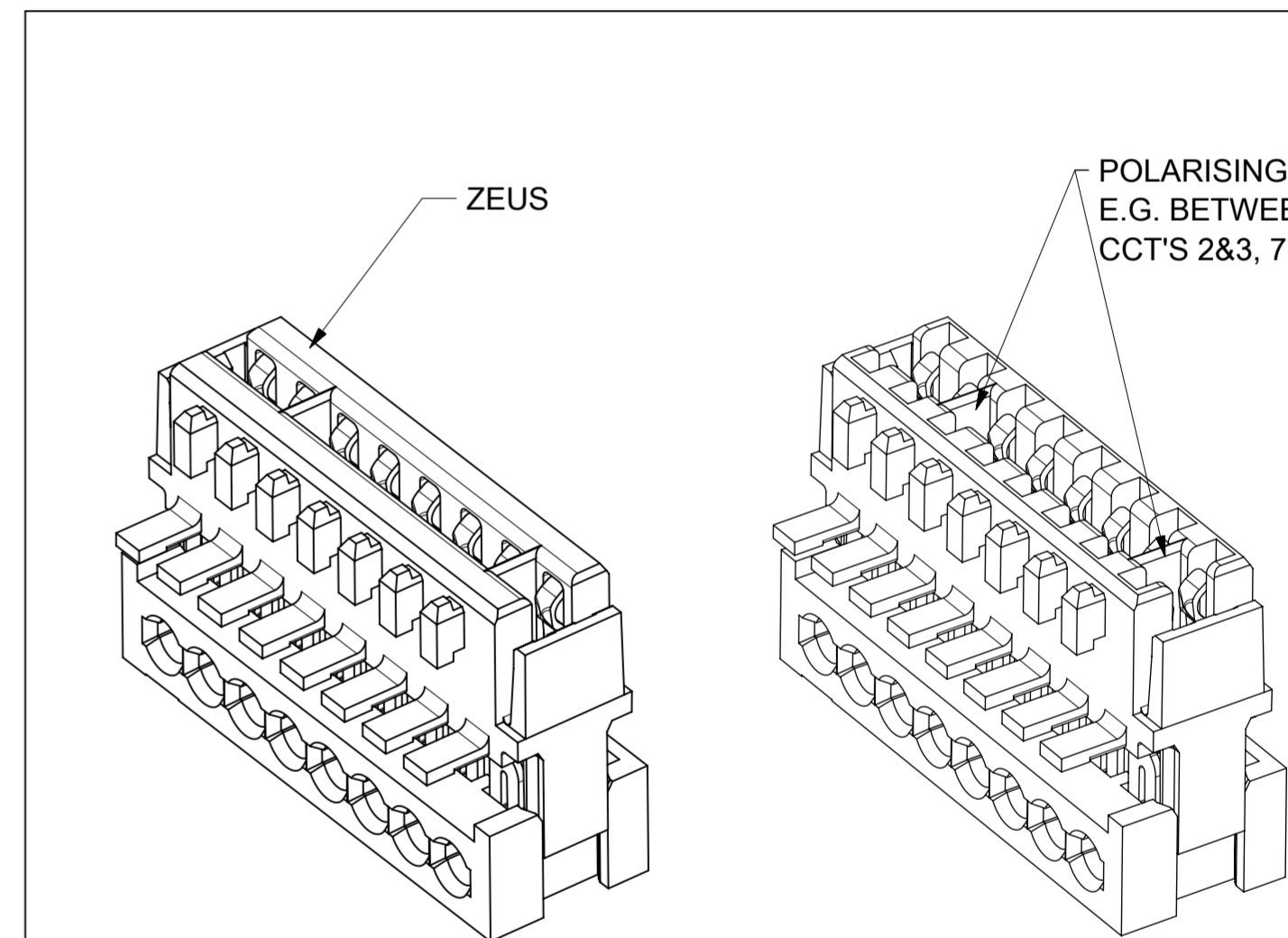
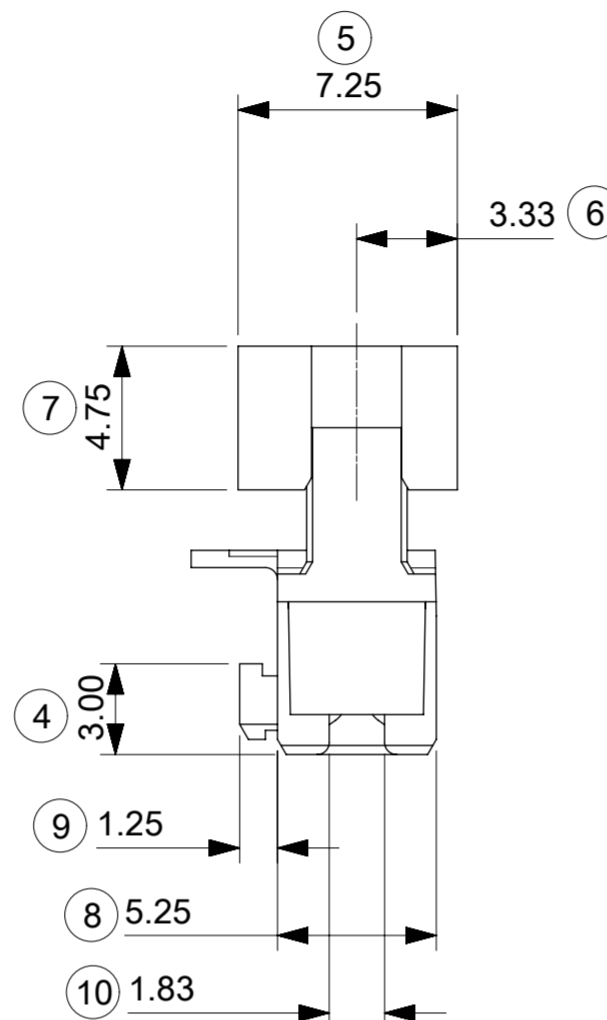
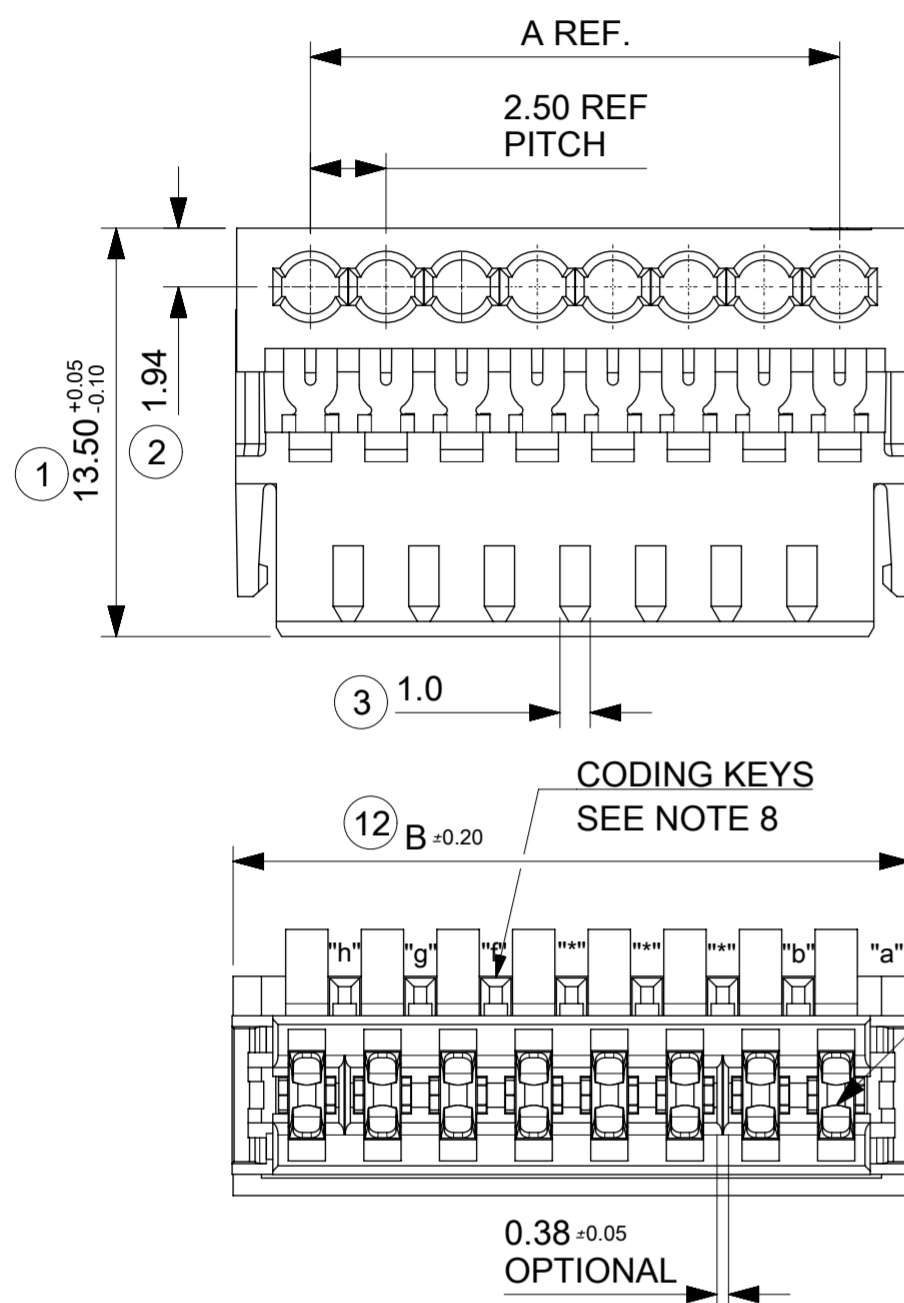

EXAMPLE OF PCB LAYOUT FOR CONNECTOR SHOWN ABOVE
 - 8CCT WITH POLARISING RIB BETWEEN CCT 1&2 AND 6&7
 - RECCOMENDED PCB THICKNESS: 1.50±0.14mm

NOTES:

- MATERIAL: HOUSING -NYLON PA6 7% GF UL94-V2 COLOUR: NATURAL
 TERMINAL - COPPER ALLOY
- PLATING: TIN
- PRODUCT CONFORMS TO PRODUCT SPECIFICATION PS-99020-0040
- APPLICATION SPECIFICATION 990330008 AS
- SEE SUBSEQUENT SHEETS FOR PART NUMBERS
- POLARISING RIBS ARE RECOMMENDED WITH THIS PRODUCT.
 SEE CONFIGURATIONS ON FOLLOWING SHEETS FOR OPTIONAL
 POLARISING RIB POSITION(S) FOR EACH CCT SIZE.
 RECOMMENDED: 3CCT TO 6 CCT HAVE ONE POLARISING RIB
 7CCT TO 20 CCT HAVE TWO POLARISING RIBS
- COLOR STRIPE IS OPTIONAL. AVAILABLE IN THE FOLLOWING
 COLORS: BLACK, RED, BLUE, GREEN
- NO CODING KEY "a", AS LATCH REPLACES FIRST AND LAST
 CODING KEY.
- REFER TO PACKAGING SPECIFICATION: PK-90871-001

THIS DRAWING CONTAINS INFORMATION THAT IS PROPRIETARY TO MOLEX ELECTRONIC TECHNOLOGIES, LLC AND SHOULD NOT BE USED WITHOUT WRITTEN PERMISSION									
DIMENSION UNITS		SCALE		CURRENT REV DESC: UPDATED CONFIG					
mm		20:1							
GENERAL TOLERANCES (UNLESS SPECIFIED)				EC NO: 618006					
ANGULAR TOL ± 0.5°				4 PLACES ±		DRWN: AKABADI		2019/05/27	
				3 PLACES ± 0.1		CHK'D: TCLEARY		2019/05/27	
				2 PLACES ± 0.1		APPR: DRYAN		2019/06/07	
				1 PLACE ± 0.2		INITIAL REVISION:			
				0 PLACES ±		DRWN: CFISHER01		2016/08/05	
				DRAFT WHERE APPLICABLE MUST REMAIN WITHIN DIMENSIONS		APPR: BRUTTLE		2016/10/13	
THIRD ANGLE PROJECTION		DRAWING		SERIES		MATERIAL NUMBER		CUSTOMER	
A2-SIZE		91780		SEE CHARTS		GENERAL MARKET		SHEET NUMBER	
DOCUMENT NUMBER				DOC TYPE		DOC PART		REVISION	
917800001				PSD		000		Y	

molex

2.5MM APPLI-MATE
 W/SIDE LATCHES (2.5 & 5MM TERM PITCH)
 ADDITION OF PART NUMBERS 91780-2513 & 9178

PRODUCT CUSTOMER DRAWING

2 CIRCUIT						
PART NUMBER	HOUSING USED	TERMINAL VOID POSITION	REMOVED POSITION KEYS	CONFIGURATION	POLARIZING RIB BETWEEN	COLOUR STRIPE
91780-9001	94009-0103	CCT 2	a d		1&2	NONE
91780-9002	94009-0203	CCT 2	a d		2&3	NONE
91780-9003	94009-0003	CCT 2	a d		NONE	NONE
91780-9004	94009-0103	CCT 2	a c d		1&2	RED
91780-9005	94009-0103	CCT 2	a b d		1&2	GREEN
91780-9006	94009-0203	CCT 2	a c d		2&3	BLUE
91780-9007	94009-0203	CCT 2	a b d		2&3	BLACK
91780-9008	94009-0103	CCT 2	a c d		1&2	NONE
91780-9009	94009-0203	CCT 2	a c d		2&3	NONE
91780-9010	94009-0203	CCT 2	a b d		2&3	NONE
91780-9011	94009-0103	CCT 2	a b d		1&2	NONE
91780-9012	94009-0103	CCT 2	a d		1&2	RED
91780-9013	94009-0103	CCT 2	a c d		1&2	BLUE
91780-9014	94009-0203	CCT 2	a d		2&3	GREEN
91780-9015	94009-0103	CCT 2	a d		1&2	GREEN
91780-9016	94009-0003	CCT 2	a c d		NONE	RED
91780-9017	94009-0003	CCT 2	a b d		NONE	GREEN
91780-9018	94009-0203	CCT 2	a d		2&3	NONE
91780-9019	94007-0103 ZEUS	CCT 2	a d		1&2	GREEN

3 CIRCUIT						
PART NUMBER	HOUSING USED	TERMINAL VOID POSITION	REMOVED POSITION KEYS	CONFIGURATION	POLARIZING RIB BETWEEN	COLOUR STRIPE
91780-0001	94009-0103	NONE	a d		1&2	NONE
91780-0002	94009-0003	NONE	a c d		NONE	NONE
91780-0003	94009-0203	NONE	a d		2&3	NONE
91780-0004	94009-0103	NONE	a c d		1&2	NONE
91780-0005	94009-0103	NONE	a b d		1&2	NONE
91780-0006	94009-0203	NONE	a d		2&3	BLACK
91780-0007	94009-0103	NONE	a d		1&2	RED
91780-0009	94009-0103	NONE	a c d		1&2	BLUE
91780-0010	94009-0103	NONE	a b d		1&2	BLACK
91780-0012	94007-0203 ZEUS	NONE	a d		2&3	BLACK
91780-0013	94007-0003 ZEUS	NONE	a d		NONE	NONE
91780-0014	94007-0103 ZEUS	NONE	a d		1&2	RED
91780-0015	94007-0103 ZEUS	NONE	a d		1&2	NONE
91780-0016	94007-0103 ZEUS	CCT 2	a d		1&2	GREEN
91780-0017	94007-0103 ZEUS	CCT 2	a d		1&2	NONE

4 CIRCUIT						
PART NUMBER	HOUSING USED	TERMINAL VOID POSITION	REMOVED POSITION KEYS	CONFIGURATION	POLARIZING RIB BETWEEN	COLOUR STRIPE
91780-0501	94009-0104	NONE	a e		1&2	NONE
91780-0502	94009-0004	NONE	a e		NONE	NONE
91780-0503	94009-0004	CCT 3	a b e		NONE	RED
91780-0504	94009-0004	NONE	a d e		NONE	BLACK
91780-0505	94009-0004	NONE	a d e		NONE	NONE
91780-0506	94009-0004	CCT 3	a b e		NONE	NONE
91780-0507	94009-0104	NONE	a e		1&2	BLACK
91780-0508	94009-0004	NONE	a e		NONE	RED
91780-0509	94009-0104	NONE	a c e		1&2	NONE
91780-0510	94009-0304	NONE	a e		3&4	NONE
91780-0511	94009-0104	CCT 1	a c e		1&2	NONE
91780-0512	94009-0204	NONE	a e		2&3	BLACK
91780-0515	94007-0104 ZEUS	NONE	a e		1&2	BLACK
91780-0516	94007-0304 ZEUS	NONE	a e		3&4	RED
91780-0517	94007-0104 ZEUS	NONE	a e		1&2	NONE

NOTES

- + DENOTES TERMINAL VOIDED POSITION
⊕ DENOTES TERMINAL LOADED POSITION
| DENOTES POLARIZING RIB POSITION
- MOLEX HOUSING NO. FOR REFERENCE ONLY

THIS DRAWING CONTAINS INFORMATION THAT IS PROPRIETARY TO MOLEX ELECTRONIC TECHNOLOGIES, LLC AND SHOULD NOT BE USED WITHOUT WRITTEN PERMISSION

DIMENSION UNITS	SCALE	CURRENT REV DESC: UPDATED CONFIG		molex		
mm	1:1					
GENERAL TOLERANCES (UNLESS SPECIFIED)		EC NO: 618006		2.5MM APPLI-MATE W/SIDE LATCHES (2.5 & 5MM TERM PITCH) ADDITION OF PART NUMBERS 91780-2513 & 9178		
ANGULAR TOL	± 0.5°	DRWN: AKABADI	2019/05/27			
4 PLACES	±	CHK'D: TCLEARY	2019/05/27	PRODUCT CUSTOMER DRAWING		
3 PLACES	± 0.1	APPR: DRYAN	2019/06/07			
2 PLACES	± 0.1	INITIAL REVISION:		DOCUMENT NUMBER		
1 PLACE	± 0.2	DRWN: CFISHER01	2016/08/05			
0 PLACES	±	APPR: BRUTTLE	2016/10/13	DOC TYPE	DOC PART	REVISION
DRAFT WHERE APPLICABLE MUST REMAIN WITHIN DIMENSIONS	THIRD ANGLE PROJECTION	DRAWING	SERIES	MATERIAL NUMBER	CUSTOMER	SHEET NUMBER
		A2-SIZE	91780	SEE CHARTS	GENERAL MARKET	2 OF 5

5 CIRCUIT						
PART NUMBER	HOUSING USED	TERMINAL VOID POSITION	REMOVED POSITION KEYS	CONFIGURATION	POLARIZING RIB BETWEEN	COLOUR STRIPE
91780-1001	94009-0205	NONE	a f		2&3	NONE
91780-1002	94009-0105	NONE	a f		1&2	NONE
91780-1003	94009-0205	NONE	a f		2&3	BLACK
91780-1004	94009-0105	CCT 4	a f		1&2	GREEN
91780-1005	94009-0305	NONE	a f		3&4	RED
91780-1006	94009-0305	CCT 2	a f		3&4	BLUE
91780-1007	94009-0005	NONE	a f		NONE	NONE
91780-1008	94009-0105	CCT 3	a f		1&2	NONE
91780-1009	94009-0205	CCT 1	a f		2&3	NONE
91780-1010	94009-0405	CCT 1,2	a f		4&5	NONE
91780-1011	94009-0205	CCT 1,3,5	a f		2&3	RED
91780-1012	94009-0205	CCT5	a f		2&3	NONE
91780-1013	94009-0405	NONE	a b c d e f		4&5	NONE
91780-1014	94009-0005	NONE	a c d f		NONE	NONE
91780-1015	94009-0305	NONE	a f		3&4	NONE
91780-1016	94009-0005	NONE	a c d e f		NONE	NONE
91780-1017	94009-0005	NONE	a b c d e f		NONE	NONE
91780-1021	94007-0305 ZEUS	NONE	a f		3&4	RED
91780-1022	94009-0005	CCT 3	a b c d e f		NONE	NONE
91780-1023	94007-0205 ZEUS	NONE	a f		2&3	BLACK
91780-1024	94007-0305 ZEUS	CCT 2	a f		3&4	BLUE
91780-1025	94007-0105 ZEUS	CCT 1,2	a f		1&2	ORANGE
91780-1026	94007-0105 ZEUS	CCT 4	a f		1&2	GREEN
91780-1027	94009-0105	NONE	a f		1&2	GREEN
91780-1028	94007-0105 ZEUS	NONE	a f		1&2	NONE

6 CIRCUIT						
PART NUMBER	HOUSING USED	TERMINAL VOID POSITION	REMOVED POSITION KEYS	CONFIGURATION	POLARIZING RIB BETWEEN	COLOUR STRIPE
91780-1501	94009-0206	NONE	a g		2&3	NONE
91780-1502	94009-0506	NONE	a g		5&6	NONE
91780-1503	94009-0206	NONE	a g		2&3	BLACK
91780-1504	94009-0206	NONE	a g		2&3	BLUE
91780-1505	94009-0106	NONE	a g		1&2	NONE
91780-1506	94009-0406	NONE	a g		4&5	NONE
91780-1507	94009-0006	NONE	a g		NONE	NONE
91780-1508	94009-0406	CCT 3,5	a g		4&5	GREEN
91780-1509	94009-0406	NONE	a g		4&5	RED
91780-1510	94009-0206	CCT 2,5	a g		2&3	BLACK
91780-1511	94009-0306	NONE	a g		3&4	NONE
91780-1512	94009-0406	CCT 2,4	a g		4&5	GREEN
91780-1513	94009-0206	CCT 2,4	a g		2&3	BLUE
91780-1514	94009-0206	CCT 2,5	a g		2&3	NONE
91780-1515	94009-0206	CCT 2,4	a g		2&3	NONE
91780-1517	94007-0206 ZEUS	CCT 2,5	a g		2&3	BLACK
91780-1518	94007-0506 ZEUS	NONE	a g		5&6	NONE
91780-1519	94007-0206 ZEUS	NONE	a g		2&3	NONE
91780-1520	94007-0406 ZEUS	NONE	a g		4&5	RED
91780-1521	94007-0106 ZEUS	NONE	a g		1&2	NONE
91780-1522	94007-0406 ZEUS	CCT 2,4	a g		4&5	GREEN
91780-1523	94007-0406 ZEUS	CCT 3,5	a g		4&5	GREEN
91780-1524	94007-0406 ZEUS	NONE	a g		4&5	NONE

NOTES

- + DENOTES TERMINAL VOIDED POSITION
 - ⊕ DENOTES TERMINAL LOADED POSITION
 - | DENOTES POLARIZING RIB POSITION
2. MOLEX HOUSING NO. FOR REFERENCE ONLY

THIS DRAWING CONTAINS INFORMATION THAT IS PROPRIETARY TO MOLEX ELECTRONIC TECHNOLOGIES, LLC AND SHOULD NOT BE USED WITHOUT WRITTEN PERMISSION									
DIMENSION UNITS		SCALE		CURRENT REV DESC: UPDATED CONFIG					
mm		1:1							
GENERAL TOLERANCES (UNLESS SPECIFIED)				<p>molex</p> <p>2.5MM APPLI-MATE W/SIDE LATCHES (2.5 & 5MM TERM PITCH) ADDITION OF PART NUMBERS 91780-2513 & 9178</p> <p>PRODUCT CUSTOMER DRAWING</p>					
ANGULAR TOL		± 0.5°							
4 PLACES		±							
3 PLACES		± 0.1							
2 PLACES		± 0.1							
1 PLACE		± 0.2		INITIAL REVISION:		DOCUMENT NUMBER		DOC TYPE DOC PART REVISION	
0 PLACES		±		DRWN: BRUTTLE		917800001		PSD 000 Y	
DRAFT WHERE APPLICABLE MUST REMAIN WITHIN DIMENSIONS		THIRD ANGLE PROJECTION		DRAWING		SERIES		MATERIAL NUMBER CUSTOMER	
				A2-SIZE		91780		SEE CHARTS GENERAL MARKET	
								SHEET NUMBER	
								3 OF 5	

7 CIRCUIT						
PART NUMBER	HOUSING USED	TERMINAL VOID POSITION	REMOVED POSITION KEYS	CONFIGURATION	POLARIZING RIB BETWEEN	COLOUR STRIPE
91780-2001	94009-2307	NONE	a h		1&2 5&6	NONE
91780-2002	94009-0107	CCT 2	a h		1&2	NONE
91780-2003	94009-0207	NONE	a h		2&3	BLACK
91780-2004	94009-0507	NONE	a h		5&6	NONE
91780-2005	94009-0207	CCT 2,4	a h		2&3	BLUE
91780-2006	94009-0007	NONE	a h		NONE	NONE
91780-2007	94009-0007	CCT 2,4,6	a h		NONE	NONE
91780-2008	94009-0207	CCT 2,4,6	a h		2&3	BLUE
91780-2010	94007-0207 ZEUS	CCT 2,4,6	a h		2&3	BLUE
91780-2011	94007-0207 ZEUS	CCT 2,4	a h		2&3	BLUE
91780-2012	94007-0507 ZEUS	NONE	a h		5&6	NONE

8 CIRCUIT						
PART NUMBER	HOUSING USED	TERMINAL VOID POSITION	REMOVED POSITION KEYS	CONFIGURATION	POLARIZING RIB BETWEEN	COLOUR STRIPE
91780-2501	94009-2408	NONE	a i		1&2 6&7	NONE
91780-2502	94009-2408	CCT 2,5	a i		1&2 6&7	NONE
91780-2503	94009-2408	CCT 2	a i		1&2 6&7	NONE
91780-2504	94009-0208	NONE	a i		2&3	NONE
91780-2505	94009-0208	CCT 2,5	a i		2&3	NONE
91780-2506	94009-0108	NONE	a i		1&2	NONE
91780-2507	94009-0308	NONE	a i		3&4	NONE
91780-2508	94009-0308	NONE	a i		3&4	RED
91780-2509	94009-0208	CCT 2,4,5,6	a i		2&3	NONE
91780-2510	94009-0208	CCT 2,5	a i		2&3	BLUE
91780-2511	94009-0008	NONE	a i		NONE	NONE
91780-2512	94009-0208	CCT 2, 3	a i		2&3	NONE
91780-2513	94009-0508	NONE	a i		5&6	NONE
91780-2514	94007-0208 ZEUS	NONE	a i		2&3	NONE
91780-2515	94007-0208 ZEUS	CCT 2,5	a i		2&3	BLUE
91780-2516	94007-0208 ZEUS	CCT 5,7	a i		2&3	BROWN

9 CIRCUIT						
PART NUMBER	HOUSING USED	TERMINAL VOID POSITION	REMOVED POSITION KEYS	CONFIGURATION	POLARIZING RIB BETWEEN	COLOUR STRIPE
91780-3001	94009-2509	NONE	a j		1&2 7&8	NONE
91780-3426	94009-2509	CCT 2 4 6 8	a j		1&2 7&8	NONE
91780-3003	94009-0209	CCT 2	a j		2&3	GREEN
91780-3004	94009-0209	CCT 2,4,6	a j		2&3	BLACK
91780-3005	94009-0309	CCT 2,5,7	a j		3&4	GREY
91780-3006	94009-0209	CCT 3,5,8	a j		2&3	GREEN
91780-3007	94009-0409	CCT 3,5,7	a j		4&5	RED
91780-3008	94009-0209	NONE	a j		2&3	BLACK
91780-3009	94009-0209	NONE	a j		2&3	NONE
91780-3011	94007-0209 ZEUS	CCT 3,5,8	a j		2&3	GREEN
91780-3012	94007-0009 ZEUS	CCT 2,4,6,8	a j		NONE	NONE

10 CIRCUIT						
PART NUMBER	HOUSING USED	TERMINAL VOID POSITION	REMOVED POSITION KEYS	CONFIGURATION	POLARIZING RIB BETWEEN	COLOUR STRIPE
91780-3501	94009-2610	NONE	a k		1&2 8&9	NONE
91780-3502	94009-0910	NONE	a k		9&10	RED
91780-3503	94009-0910	NONE	a k		9&10	NONE
91780-3504	94009-0210	NONE	a k		2&3	NONE
91780-3505	94009-0210	NONE	a k		2&3	BLACK
91780-3506	94009-0010	NONE	a k		NONE	NONE
91780-3507	94007-0210 ZEUS	CCT 2,4	a k		2&3	NONE

NOTES

- + DENOTES TERMINAL VOIDED POSITION
⊕ DENOTES TERMINAL LOADED POSITION
| DENOTES POLARIZING RIB POSITION
- MOLEX HOUSING NO. FOR REFERENCE ONLY

THIS DRAWING CONTAINS INFORMATION THAT IS PROPRIETARY TO MOLEX ELECTRONIC TECHNOLOGIES, LLC AND SHOULD NOT BE USED WITHOUT WRITTEN PERMISSION													
DIMENSION UNITS		SCALE		CURRENT REV DESC: UPDATED CONFIG									
mm		1:1		<p>2.5MM APPLI-MATE W/SIDE LATCHES (2.5 & 5MM TERM PITCH) ADDITION OF PART NUMBERS 91780-2513 & 9178</p> <p>PRODUCT CUSTOMER DRAWING</p>									
GENERAL TOLERANCES (UNLESS SPECIFIED)										EC NO: 618006		2019/05/27	
ANGULAR TOL ± 0.5°										DRWN: AKABADI		2019/05/27	
4 PLACES ±										CHK'D: TCLEARY		2019/06/07	
3 PLACES ± 0.1				APPR: DRYAN		2019/06/07		DOCUMENT NUMBER					
2 PLACES ± 0.1				INITIAL REVISION:		2016/08/05		917800001					
1 PLACE ± 0.2				DRWN: CFISHER01		2016/10/13		DOC TYPE DOC PART REVISION					
0 PLACES ±				APPR: BRUTTLE		2016/10/13		PSD 000 Y					
DRAFT WHERE APPLICABLE MUST REMAIN WITHIN DIMENSIONS			THIRD ANGLE PROJECTION		DRAWING		SERIES		SHEET NUMBER				
					A2-SIZE		91780		4 OF 5				
					MATERIAL NUMBER		CUSTOMER						
					SEE CHARTS		GENERAL MARKET						

11 CIRCUIT						
PART NUMBER	HOUSING USED	TERMINAL VOID POSITION	REMOVED POSITION KEYS	CONFIGURATION	POLARIZING RIB BETWEEN	COLOUR STRIPE
91780-4001	94009-2711	NONE	a l		1&2 9&10	NONE
91780-4002	94009-0411	NONE	a l		4&5	NONE
91780-4003	94009-0211	NONE	a l		2&3	NONE
91780-4004	94009-0211	CCT 6, 7	a l		2&3	NONE

12 CIRCUIT						
PART NUMBER	HOUSING USED	TERMINAL VOID POSITION	REMOVED POSITION KEYS	CONFIGURATION	POLARIZING RIB BETWEEN	COLOUR STRIPE
91780-4501	94009-2812	NONE	a m		1&2 10&11	NONE
91780-4502	94009-2812	CCT 2 5 8 10	a m		1&2 10&11	NONE
91780-4503	94009-0212	NONE	a m		2&3	NONE
91780-4504	94009-0212	CCT 2 5 8 10	a m		2&3	NONE
91780-4505	94009-0212	NONE	a m		2&3	BLACK
91780-4506	94009-1112	NONE	a m		11&12	NONE
91780-4507	94009-0012	NONE	a m		NONE	NONE
91780-4508	94007-0212 ZEUS	NONE	a m		2&3	BLACK

13 CIRCUIT						
PART NUMBER	HOUSING USED	TERMINAL VOID POSITION	REMOVED POSITION KEYS	CONFIGURATION	POLARIZING RIB BETWEEN	COLOUR STRIPE
91780-5001	94009-2913	NONE	a n		1&2 11&12	NONE
91780-5002	94009-0213	NONE	a n		2&3	NONE
91780-5004	94009-0213	CCT 7 9 12	a n		2&3	NONE
91780-5005	94007-0213 ZEUS	NONE	a n		2&3	NONE

14 CIRCUIT						
PART NUMBER	HOUSING USED	TERMINAL VOID POSITION	REMOVED POSITION KEYS	CONFIGURATION	POLARIZING RIB BETWEEN	COLOUR STRIPE
91780-5501	94009-3014	NONE	a o		1&2 12&13	NONE

15 CIRCUIT						
PART NUMBER	HOUSING USED	TERMINAL VOID POSITION	REMOVED POSITION KEYS	CONFIGURATION	POLARIZING RIB BETWEEN	COLOUR STRIPE
91780-6001	94009-3115	NONE	a p		1&2 13&14	NONE
91780-6426	94009-3115	CCT 2,4,6,8,10,12,14	a p		1&2 13&14	NONE

16 CIRCUIT						
PART NUMBER	HOUSING USED	TERMINAL VOID POSITION	REMOVED POSITION KEYS	CONFIGURATION	POLARIZING RIB BETWEEN	COLOUR STRIPE
91780-6501	94009-3216	NONE	a q		1&2 14&15	NONE

17 CIRCUIT						
PART NUMBER	HOUSING USED	TERMINAL VOID POSITION	REMOVED POSITION KEYS	CONFIGURATION	POLARIZING RIB BETWEEN	COLOUR STRIPE
91780-7001	94009-3317	NONE	a r		1&2 15&16	NONE
91780-7002	94009-6617	CCT 2,4,5,6,8,10,12,14,16	a r		3&4 15&16	NONE

18 CIRCUIT						
PART NUMBER	HOUSING USED	TERMINAL VOID POSITION	REMOVED POSITION KEYS	CONFIGURATION	POLARIZING RIB BETWEEN	COLOUR STRIPE
91780-7501	94009-3418	NONE	a s		1&2 16&17	NONE

19 CIRCUIT						
PART NUMBER	HOUSING USED	TERMINAL VOID POSITION	REMOVED POSITION KEYS	CONFIGURATION	POLARIZING RIB BETWEEN	COLOUR STRIPE
91780-8001	94009-3519	NONE	a t		1&2 17&18	NONE

20 CIRCUIT						
PART NUMBER	HOUSING USED	TERMINAL VOID POSITION	REMOVED POSITION KEYS	CONFIGURATION	POLARIZING RIB BETWEEN	COLOUR STRIPE
91780-8501	94009-3620	NONE	a u		1&2 18&19	NONE

NOTES

- + DENOTES TERMINAL VOIDED POSITION
- ⊕ DENOTES TERMINAL LOADED POSITION
- | DENOTES POLARIZING RIB POSITION
2. MOLEX HOUSING NO. FOR REFERENCE ONLY

THIS DRAWING CONTAINS INFORMATION THAT IS PROPRIETARY TO MOLEX ELECTRONIC TECHNOLOGIES, LLC AND SHOULD NOT BE USED WITHOUT WRITTEN PERMISSION

DIMENSION UNITS	SCALE	CURRENT REV DESC: UPDATED CONFIG			molex		
mm	1:1						
GENERAL TOLERANCES (UNLESS SPECIFIED)		EC NO: 618006			2.5MM APPLI-MATE W/SIDE LATCHES (2.5 & 5MM TERM PITCH) ADDITION OF PART NUMBERS 91780-2513 & 9178		
ANGULAR TOL	± 0.5°	DRWN: AKABADI 2019/05/27					
4 PLACES	±	CHK'D: TCLEARY 2019/05/27			PRODUCT CUSTOMER DRAWING		
3 PLACES	± 0.1	APPR: DRYAN 2019/06/07					
2 PLACES	± 0.1	INITIAL REVISION:			DOCUMENT NUMBER		
1 PLACE	± 0.2	DRWN: CFISHER01 2016/08/05					
0 PLACES	±	APPR: BRUTTLE 2016/10/13			DOC TYPE		
DRAFT WHERE APPLICABLE MUST REMAIN WITHIN DIMENSIONS		THIRD ANGLE PROJECTION	DRAWING	SERIES			
			A2-SIZE	91780	SEE CHARTS	GENERAL MARKET	Y
							SHEET NUMBER
							5 OF 5

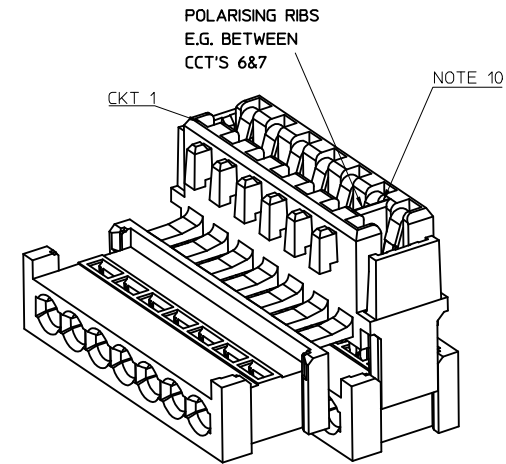
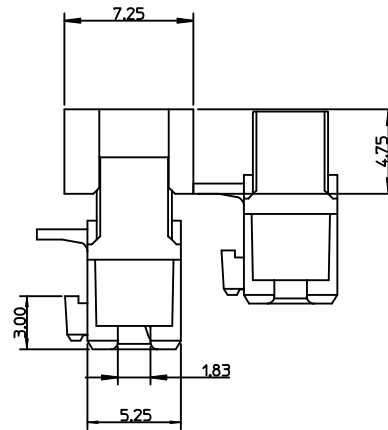
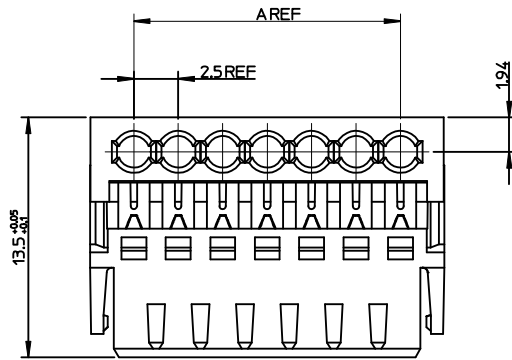

CCT	DIM A	DIM B
3	5.0	9.875
4	7.5	12.375
5	10.0	14.875
6	12.5	17.375
7	15.0	19.875
8	17.5	22.375
9	20.0	24.875
10	22.5	27.375
11	25.0	29.875
12	27.5	32.375
13	30.0	34.875
14	32.5	37.375
15	35.0	39.875
16	37.5	42.375
17	40.0	44.875
18	42.5	47.375
19	45.0	49.875
20	47.5	52.375

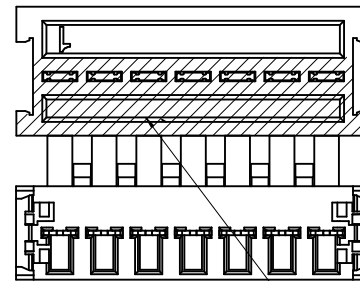
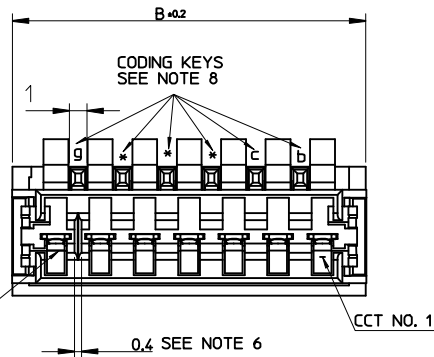

NOTES:

- MATERIAL: HOUSING - NYLON PA6 COLOUR: NATURAL
TERMINAL - COPPER ALLOY
- PLATING: TIN
- PRODUCT CONFORMS TO PRODUCT SPECIFICATION PS-92336-001
- APPLICATION SPECIFICATION AS-99033-0008
- SEE SUBSEQUENT SHEETS FOR PART NUMBERS
- POLARISING RIBS ARE RECOMMENDED WITH THIS PRODUCT.
SEE CONFIGURATIONS ON FOLLOWING SHEETS FOR OPTIONAL POLARISING RIB POSITION(S) FOR EACH CCT SIZE.
RECOMMENDED: 3CCT TO 6 CCT HAVE ONE POLARISING RIB
7CCT TO 20 CCT HAS TWO POLARISING RIBS
- COLOR STRIPE IS OPTIONAL. AVAILABLE IN THE FOLLOWING COLORS: BLACK, RED, BLUE, GREEN
- NO CODING KEY "a", AS LATCH REPLACES FIRST AND LAST CODING KEY.
- REFER TO PACKAGING SPECIFICATION: PK-90871-001
- THE POSITIONAL RIB SLOT CAN BE PLACED BETWEEN ANY TWO CIRCUITS TO SUIT MATING CONNECTOR. ABOVE SKETCH SHOWS A PARTICULAR EXAMPLE

COLOR STRIPE TO BE WITHIN SHADED AREA (OPTIONAL) SEE NOTE 7.

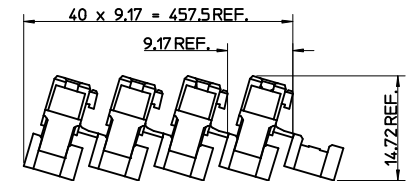

SHIPPING ARRANGEMENT

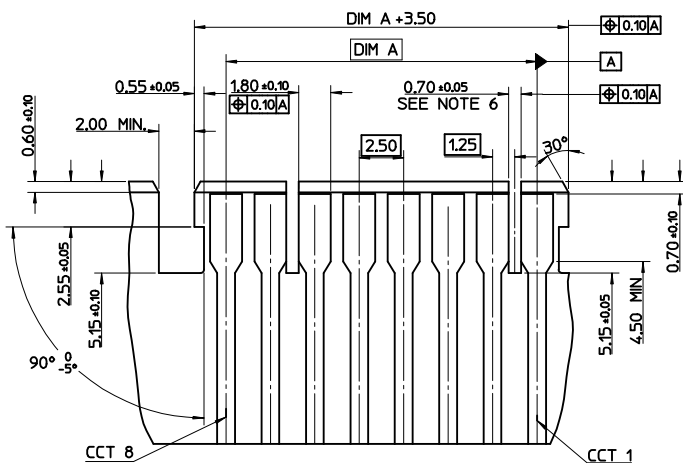

EXAMPLE OF PCB LAYOUT FOR THIS CONNECTOR SHOWN ABOVE
 - 8CCT WITH POLARISING RIB BETWEEN CCT 1&2 AND 6&7
 - RECOMMENDED PCB THICKNESS: 1.50±0.14mm

ADDED NEW PART NUMBERS EC NO: IPG2014-1186 DRAWN: CMONAHAN 2014/01/07 CHKD: APPR: STGRUFFIN 2014/01/30	QUALITY SYMBOLS ▽=0 ▽=0	GENERAL TOLERANCES (UNLESS SPECIFIED)		DIMENSION STYLE MM ONLY		SCALE 5:1	DESIGN UNITS METRIC	THIRD ANGLE PROJECTION
		4 PLACES ± --- ± --- 3 PLACES ± 0.10 ± --- 2 PLACES ± 0.10 ± --- 1 PLACE ± 0.2 ± --- ANGULAR ± 2 °	m/m INCH --- --- ± 0.10 ± --- ± 0.10 ± --- ± 0.2 ± ---	DRAWN BY N. MCNAMA DATE 2004/09/07	CHECKED BY J DENNEHY DATE 2004/09/08	TITLE 2.5MM SIGNAL W/SIDE LATCHES (2.5 & 5MM TERM PITCH)		MOLEX INCORPORATED
DRAFT WHERE APPLICABLE MUST REMAIN WITHIN DIMENSIONS		APPROVED BY BMAGUIRE DATE 2011/04/19		MATERIAL NO. SEE SHEET 2-4		DOCUMENT NO. SD-92339-001	SHEET NO. 1 OF 4	
THIS DRAWING CONTAINS INFORMATION THAT IS PROPRIETARY TO MOLEX INCORPORATED AND SHOULD NOT BE USED WITHOUT WRITTEN PERMISSION								

2 CIRCUIT

MOLEX PART NO.	HOUSING PART NO.	TERMINAL VOID POSITION	REMOVED POSITION KEYS	CONFIGURATION (SEE NOTE 1)	POLARIZING RIB BETWEEN	COLOUR STRIPE
92339-9001	92340-0103	CCT 2	a d		CCT 1&2	NONE
92339-9002	92340-0203	CCT 2	a d		CCT 2&3	NONE
92339-9003	92340-0003	CCT 2	a d		NONE	NONE
92339-9004	92340-0103	CCT 2	a c d		CCT 1&2	RED
92339-9005	92340-0103	CCT 2	a b d		CCT 1&2	GREEN
92339-9006	92340-0203	CCT 2	a c d		CCT 2&3	BLUE
92339-9007	92340-0203	CCT 2	a b d		CCT 2&3	BLACK
92339-9008	92340-0103	CCT 2	a c d		CCT 1&2	NONE
92339-9009	92340-0203	CCT 2	a c d		CCT 2&3	NONE
92339-9010	92340-0203	CCT 2	a b d		CCT 2&3	NONE
92339-9011	92340-0103	CCT 2	a b d		CCT 1&2	NONE
92339-9013	92340-0103	CCT 2	a c d		CCT 1&2	BLUE
92339-9014	92340-0203	CCT 2	a d		CCT 2&3	GREEN
92339-9015	92340-0003	CCT 2	a c d		NONE	RED
92339-9016	92340-0003	CCT 2	a b d		NONE	GREEN

3 CIRCUIT

MOLEX PART NO.	HOUSING PART NO.	TERMINAL VOID POSITION	REMOVED POSITION KEYS	CONFIGURATION (SEE NOTE 1)	POLARIZING RIB BETWEEN	COLOUR STRIPE
92339-0001	92340-0103	NONE	a d		CCT 1&2	NONE
92339-0002	92340-0003	NONE	a c d		NONE	NONE
92339-0003	92340-0203	NONE	a d		CCT 2&3	NONE
92339-0004	92340-0103	NONE	a c d		CCT 1&2	NONE
92339-0005	92340-0103	NONE	a b d		CCT 1&2	NONE
92339-0006	92340-0203	NONE	a d		CCT 2&3	BLACK
92339-0007	92340-0103	NONE	a d		CCT 1&2	RED
92339-0008	92340-0103	CCT 2	a d		CCT 1&2	GREEN

4 CIRCUIT

MOLEX PART NO.	HOUSING PART NO.	TERMINAL VOID POSITION	REMOVED POSITION KEYS	CONFIGURATION (SEE NOTE 1)	POLARIZING RIB BETWEEN	COLOUR STRIPE
92339-0501	92340-0104	NONE	a e		CCT 1&2	NONE
92339-0502	92340-0004	NONE	a e		NONE	NONE
92339-0503	92340-0004	CCT 3	a b e		NONE	RED
92339-0504	92340-0004	NONE	a d e		NONE	BLACK
92339-0505	92340-0004	NONE	a d e		NONE	NONE
92339-0506	92340-0004	CCT 3	a b e		NONE	NONE
92339-0507	92340-0104	NONE	a e		CCT 1&2	BLACK
92339-0508	92340-0004	NONE	a e		NONE	RED
92339-0509	92340-0104	NONE	a c e		CCT 1&2	NONE
92339-0510	92340-0304	NONE	a e		CCT 3&4	NONE
92339-0511	92340-0004	CCT 3	NONE		NONE	GREEN

5 CIRCUIT

MOLEX PART NO.	HOUSING PART NO.	TERMINAL VOID POSITION	REMOVED POSITION KEYS	CONFIGURATION (SEE NOTE 1)	POLARIZING RIB BETWEEN	COLOUR STRIPE
92339-1001	92340-0205	NONE	a f		CCT 2&3	NONE
92339-1002	92340-0105	NONE	a f		CCT 1&2	NONE
92339-1003	92340-0205	NONE	a f		CCT 2&3	BLACK
92339-1004	92340-0105	CCT 4	a f		CCT 1&2	GREEN
92339-1005	92340-0305	NONE	a f		CCT 3&4	RED
92339-1006	92340-0305	CCT 2	a f		CCT 3&4	BLUE

- NOTES**
- 1. + DENOTES TERMINAL VOIDED POSITION
 - ⊕ DENOTES TERMINAL LOADED POSITION
 - | DENOTES POLARIZING RIB POSITION

SEE SHEET 1 ELEC NO: IPC2014-186 G DRW: N.MCNAMEHAN 2014/01/07 CHKD: APPR: STGRIFFIN 2014/01/30	QUALITY SYMBOLS ▽=0 ▽=0	GENERAL TOLERANCES (UNLESS SPECIFIED) mm INCH 4 PLACES ±.--- ±.--- 3 PLACES ±0.10 ±.--- 2 PLACES ±0.10 ±.--- 1 PLACE ±0.2 ±.--- ANGULAR ± 2 °	DIMENSION STYLE MM ONLY DRAWN BY DATE N.MCNAME 2004/09/07 CHECKED BY DATE J.DENEHY 2004/09/08 APPROVED BY DATE BMAGUIRE 2011/04/19	SCALE 1:1 DESIGN UNITS METRIC	THIRD ANGLE PROJECTION	TITLE 2.5MM SIGNAL W/SIDE LATCHES (2.5 & 5MM TERM PITCH) MOLEX INCORPORATED DOCUMENT NO. SD-92339-001 SHEET NO. 2 OF 4
	DRAFT WHERE APPLICABLE MUST REMAIN WITHIN DIMENSIONS					
	SEE CHARTS					
	THIS DRAWING CONTAINS INFORMATION THAT IS PROPRIETARY TO MOLEX INCORPORATED AND SHOULD NOT BE USED WITHOUT WRITTEN PERMISSION					

6 CIRCUIT						
MOLEX PART NO.	HOUSING PART NO.	TERMINAL VOID POSITION	REMOVED POSITION KEYS	CONFIGURATION (SEE NOTE 1)	POLARIZING RIB BETWEEN	COLOUR STRIPE
92339-1501	92340-0206	NONE	a g		CCT 2&3	NONE
92339-1502	92340-0506	NONE	a g		CCT 5&6	NONE
92339-1503	92340-0206	NONE	a g		CCT 2&3	BLACK
92339-1504	92340-0206	NONE	a g		CCT 2&3	BLUE
92339-1505	92340-0106	NONE	a g		CCT 1&2	NONE
92339-1506	92340-0406	NONE	a g		CCT 4&5	NONE
92339-1507	92340-0006	NONE	a g		NONE	NONE
92339-1508	92340-0406	CCT 3, 5	a g		CCT 4&5	GREEN
92339-1509	92340-0406	NONE	a g		CCT 4&5	RED

7 CIRCUIT						
MOLEX PART NO.	HOUSING PART NO.	TERMINAL VOID POSITION	REMOVED POSITION KEYS	CONFIGURATION (SEE NOTE 1)	POLARIZING RIB BETWEEN	COLOUR STRIPE
92339-2001	92340-2307	NONE	a h		CCT 1&2 & CCT 5&6	NONE
92339-2002	92340-0107	CCT 2	a h		CCT 1&2	NONE
92339-2003	92340-0207	NONE	a h		CCT 2&3	BLACK
92339-2004	92340-0507	NONE	a h		CCT 5&6	NONE
92339-2005	92340-0207	CCT 2&4	a h		CCT 2&3	NONE

8 CIRCUIT						
MOLEX PART NO.	HOUSING PART NO.	TERMINAL VOID POSITION	REMOVED POSITION KEYS	CONFIGURATION (SEE NOTE 1)	POLARIZING RIB BETWEEN	COLOUR STRIPE
92339-2501	92340-2408	NONE	a i		CCT 1&2 & CCT 6&7	NONE
92339-2502	92340-2408	CCT 2, 5	a i		CCT 1&2 & CCT 6&7	NONE
92339-2503	92340-2408	CCT 2	a i		CCT 1&2 & CCT 6&7	NONE
92339-2504	92340-0208	NONE	a i		CCT 2&3	NONE
92339-2505	92340-0208	CCT 2, 5	a i		CCT 2&3	NONE
92339-2506	92340-0108	NONE	a i		CCT 1&2	NONE
92339-2507	92340-0308	NONE	a i		CCT 3&4	NONE
92339-2508	92340-0308	NONE	a i		CCT 3&4	RED

NOTES
 1 + DENOTES TERMINAL VOIDED POSITION
 ⊕ DENOTES TERMINAL LOADED POSITION
 | DENOTES POLARIZING RIB POSITION

SEE SHEET 1 EC NO: 1PZ2014-1186 DRAWN BY: DRW:KONWAHAN CHECKED: APPR:STRIGRIFFIN DATE: 2014/01/30	QUALITY SYMBOLS	GENERAL TOLERANCES (UNLESS SPECIFIED)	DIMENSION STYLE	SCALE	DESIGN UNITS	THIRD ANGLE PROJECTION	
	$\nabla=0$ $\nabla=0$	mm INCH 4 PLACES ± --- ± --- 3 PLACES ± 0.10 ± --- 2 PLACES ± 0.10 ± --- 1 PLACE ± 0.2 ± --- ANGULAR ± 2°	M M ONLY	DRAWN BY: N.MCNAMA DATE: 2004/09/07 CHECKED BY: J.DENNEHY DATE: 2004/09/08 APPROVED BY: B.MAGUIRE DATE: 2011/04/19	5:1	METRIC	TITLE: 2.5MM SIGNAL W/SIDE LATCHES (2.5 & 5MM TERM PITCH) MOLEX INCORPORATED
	DRAFT WHERE APPLICABLE MUST REMAIN WITHIN DIMENSIONS	SEE CHART	MATERIAL NO.	DOCUMENT NO.	SD-92339-001		SHEET NO. 3 OF 4
	THIS DRAWING CONTAINS INFORMATION THAT IS PROPRIETARY TO MOLEX INCORPORATED AND SHOULD NOT BE USED WITHOUT WRITTEN PERMISSION						

9 CIRCUIT

MOLEX PART NO.	HOUSING PART NO.	TERMINAL VOID POSITION	REMOVED POSITION KEYS	CONFIGURATION (SEE NOTE 1)	POLARIZING RIB BETWEEN	COLOUR STRIPE
92339-3001	92340-2509	NONE	a j		CCT 1&2 & CCT 7&8	NONE
92339-3426	92340-2509	CCT 2, 4, 6, 8	a j		CCT 1&2 & CCT 7&8	NONE
92339-3003	92340-0209	CCT 2	a j		CCT 2&3	GREEN
92339-3004	92340-0209	CCT 2, 4, 6	a j		CCT 2&3	BLACK
92339-3005 PART NUMBER OBSOLETE (NO GREY STRIPE AVAILABLE)						
92339-3006	92340-0209	None	a j		CCT 2&3	BLACK
92339-3007	92340-0209	CCT 3, 5, 7	a j		CCT 2&3	GREEN
92339-3008 PART NUMBER OBSOLETE (NO GREY STRIPE AVAILABLE)						
92339-3009	92340-0209	CCT 3, 5, 8	a j		CCT 2&3	GREEN
92339-3010	92340-0409	CCT 3, 5, 7	a j		CCT 4&5	RED

12 CIRCUIT

MOLEX PART NO.	HOUSING PART NO.	TERMINAL VOID POSITION	REMOVED POSITION KEYS	CONFIGURATION (SEE NOTE 1)	POLARIZING RIB BETWEEN	COLOUR STRIPE
92339-4501	92340-2812	NONE	a m		CCT 1&2 & CCT 10&11	NONE
92339-4502	92340-2812	CCT 2, 5, 8, 10	a m		CCT 1&2 & CCT 10&11	NONE
92339-4503	92340-0212	NONE	a m		CCT 2&3	NONE
92339-4504	92340-0212	CCT 2, 5, 8, 10	a m		CCT 2&3	NONE
92339-4505	92340-0212	NONE	a m		CCT 2&3	BLACK
92339-4506	92340-1112	NONE	a m		CCT 11&12	NONE

14 CIRCUIT

MOLEX PART NO.	HOUSING PART NO.	TERMINAL VOID POSITION	REMOVED POSITION KEYS	CONFIGURATION (SEE NOTE 1)	POLARIZING RIB BETWEEN	COLOUR STRIPE
92339-5501	92340-3014	NONE	a o		CCT 1&2 & CCT 12&13	NONE

15 CIRCUIT

MOLEX PART NO.	HOUSING PART NO.	TERMINAL VOID POSITION	REMOVED POSITION KEYS	CONFIGURATION (SEE NOTE 1)	POLARIZING RIB BETWEEN	COLOUR STRIPE
92339-6001	92340-3115	NONE	a p		CCT 1&2 & CCT 13&14	NONE
92339-6426	92340-3115	CCT 2, 4, 6, 8, 10, 12, 14	a p		CCT 1&2 & CCT 13&14	NONE

16 CIRCUIT

MOLEX PART NO.	HOUSING PART NO.	TERMINAL VOID POSITION	REMOVED POSITION KEYS	CONFIGURATION (SEE NOTE 1)	POLARIZING RIB BETWEEN	COLOUR STRIPE
92339-6501	92340-3216	NONE	a q		CCT 1&2 & CCT 14&15	NONE

17 CIRCUIT

MOLEX PART NO.	HOUSING PART NO.	TERMINAL VOID POSITION	REMOVED POSITION KEYS	CONFIGURATION (SEE NOTE 1)	POLARIZING RIB BETWEEN	COLOUR STRIPE
92339-7001	92340-3317	NONE	a r		CCT 1&2 & CCT 15&16	NONE
92339-7002	92340-6617	CCT 2, 4, 5, 6, 8, 10, 12, 14, 16,	a r		CCT 3&4 & CCT 15&16	NONE

13 CIRCUIT

MOLEX PART NO.	HOUSING PART NO.	TERMINAL VOID POSITION	REMOVED POSITION KEYS	CONFIGURATION (SEE NOTE 1)	POLARIZING RIB BETWEEN	COLOUR STRIPE
92339-5001	92340-2913	NONE	a n		CCT 1&2 & CCT 11&12	NONE

18 CIRCUIT

MOLEX PART NO.	HOUSING PART NO.	TERMINAL VOID POSITION	REMOVED POSITION KEYS	CONFIGURATION (SEE NOTE 1)	POLARIZING RIB BETWEEN	COLOUR STRIPE
92339-7501	92340-3418	NONE	a s		CCT 1&2 & CCT 16&17	NONE

10 CIRCUIT

MOLEX PART NO.	HOUSING PART NO.	TERMINAL VOID POSITION	REMOVED POSITION KEYS	CONFIGURATION (SEE NOTE 1)	POLARIZING RIB BETWEEN	COLOUR STRIPE
92339-3501	92340-2610	NONE	a k		CCT 1&2 & CCT 8&9	NONE
92339-3502	92340-0910	NONE	a k		CCT 9&10	RED
92339-3503	92340-0910	NONE	a k		CCT 9&10	NONE
92339-3504	92340-0210	NONE	a k		CCT 2&3	NONE
92339-3505	92340-0210	NONE	a k		CCT 2&3	BLACK

19 CIRCUIT

MOLEX PART NO.	HOUSING PART NO.	TERMINAL VOID POSITION	REMOVED POSITION KEYS	CONFIGURATION (SEE NOTE 1)	POLARIZING RIB BETWEEN	COLOUR STRIPE
92339-8001	92340-3519	NONE	a t		CCT 1&2 & CCT 17&18	NONE

20 CIRCUIT

MOLEX PART NO.	HOUSING PART NO.	TERMINAL VOID POSITION	REMOVED POSITION KEYS	CONFIGURATION (SEE NOTE 1)	POLARIZING RIB BETWEEN	COLOUR STRIPE
92339-8501	92340-3620	NONE	a u		CCT 1&2 & CCT 18&19	NONE

11 CIRCUIT

MOLEX PART NO.	HOUSING PART NO.	TERMINAL VOID POSITION	REMOVED POSITION KEYS	CONFIGURATION (SEE NOTE 1)	POLARIZING RIB BETWEEN	COLOUR STRIPE
92339-4001	92340-2711	NONE	a l		CCT 1&2 & CCT 9&10	NONE

- NOTES**
- 1 + DENOTES TERMINAL VOIDED POSITION
 - ⊕ DENOTES TERMINAL LOADED POSITION
 - | DENOTES POLARIZING RIB POSITION

SEE SHEET 1 IEC NO: IP2014-1186 G DRWINGKONWANH CHKD: APPR:STGRIFIN REV DESCRIPTION 2014/01/07 2014/01/30	QUALITY SYMBOLS	GENERAL TOLERANCES (UNLESS SPECIFIED)	DIMENSION STYLE	SCALE	DESIGN UNITS	THIRD ANGLE PROJECTION	
	▽=0 ▽=0	mm INCH 4 PLACES ± --- ± --- 3 PLACES ± 0.10 ± --- 2 PLACES ± 0.10 ± --- 1 PLACE ± 0.2 ± --- ANGULAR ± 2°	MM ONLY DRAWN BY DATE N.MCNAME 2004/09/07 CHECKED BY DATE J.DENNEY 2004/09/08 APPROVED BY DATE B.MAGUIRE 2011/04/19	1:1	METRIC	TITLE 2.5MM SIGNAL W/SIDE LATCHES (2.5 & 5MM TERM PITCH)	
	DRAFT WHERE APPLICABLE MUST REMAIN WITHIN DIMENSIONS		SEE CHARTS MATERIAL NO. THIS DRAWING CONTAINS INFORMATION THAT IS PROPRIETARY TO MOLEX INCORPORATED AND SHOULD NOT BE USED WITHOUT WRITTEN PERMISSION	MOLEX INCORPORATED DOCUMENT NO. SD-92339-001	SHEET NO. 4 OF 4		
	INCORPORATED AND SHOULD NOT BE USED WITHOUT WRITTEN PERMISSION						

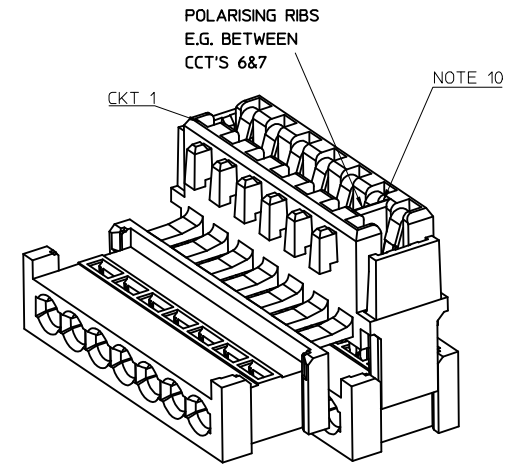
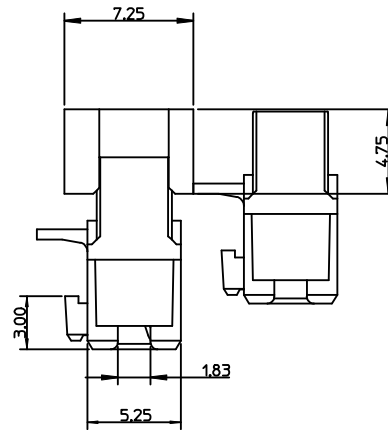
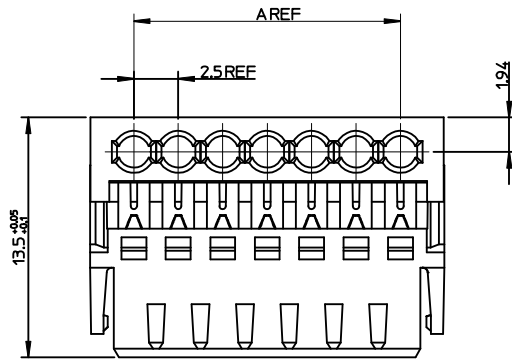

CCT	DIM A	DIM B
3	5.0	9.875
4	7.5	12.375
5	10.0	14.875
6	12.5	17.375
7	15.0	19.875
8	17.5	22.375
9	20.0	24.875
10	22.5	27.375
11	25.0	29.875
12	27.5	32.375
13	30.0	34.875
14	32.5	37.375
15	35.0	39.875
16	37.5	42.375
17	40.0	44.875
18	42.5	47.375
19	45.0	49.875
20	47.5	52.375

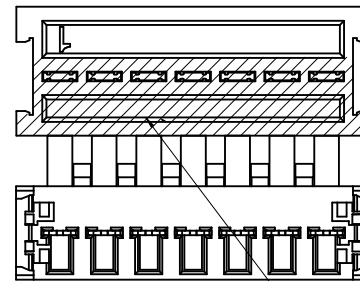
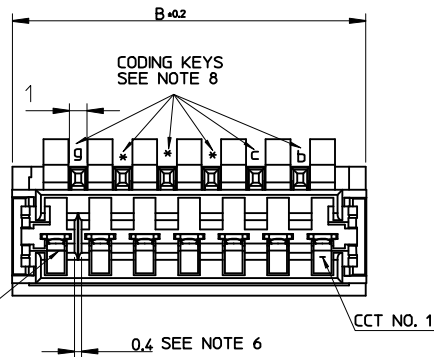

COLOR STRIPE TO BE WITHIN SHADED AREA (OPTIONAL) SEE NOTE 7.

- NOTES:
1. MATERIAL: HOUSING - NYLON PA6 COLOUR: NATURAL
TERMINAL - COPPER ALLOY
 2. PLATING: TIN
 3. PRODUCT CONFORMS TO PRODUCT SPECIFICATION PS-92336-001
 4. APPLICATION SPECIFICATION AS-99033-0008
 5. SEE SUBSEQUENT SHEETS FOR PART NUMBERS
 6. POLARISING RIBS ARE RECOMMENDED WITH THIS PRODUCT. SEE CONFIGURATIONS ON FOLLOWING SHEETS FOR OPTIONAL POLARISING RIB POSITION(S) FOR EACH CCT SIZE. RECOMMENDED: 3CCT TO 6 CCT HAVE ONE POLARISING RIB
7CCT TO 20 CCT HAS TWO POLARISING RIBS
 7. COLOR STRIPE IS OPTIONAL. AVAILABLE IN THE FOLLOWING COLORS: BLACK, RED, BLUE, GREEN
 8. NO CODING KEY "a", AS LATCH REPLACES FIRST AND LAST CODING KEY.
 9. REFER TO PACKAGING SPECIFICATION: PK-90871-001
 10. THE POSITIONAL RIB SLOT CAN BE PLACED BETWEEN ANY TWO CIRCUITS TO SUIT MATING CONNECTOR. ABOVE SKETCH SHOWS A PARTICULAR EXAMPLE

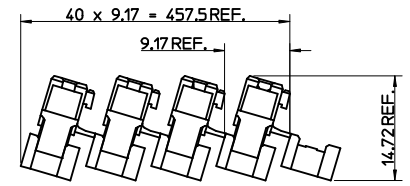



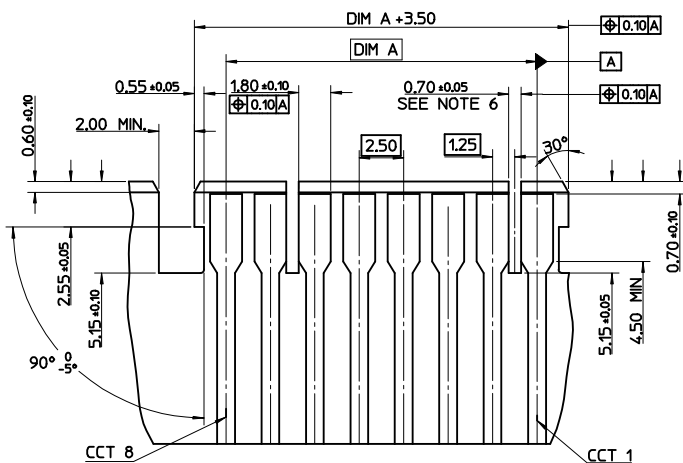











SHIPPING ARRANGEMENT











EXAMPLE OF PCB LAYOUT FOR THIS CONNECTOR SHOWN ABOVE
 - 8CCT WITH POLARISING RIB BETWEEN CCT 1&2 AND 6&7
 - RECOMMENDED PCB THICKNESS: 1.50±0.14mm

REV	DESCRIPTION	QUALITY SYMBOLS	GENERAL TOLERANCES (UNLESS SPECIFIED)		DIMENSION STYLE		SCALE	DESIGN UNITS	THIRD ANGLE PROJECTION
			mm	INCH	MM ONLY	TITLE			
0		▽=0	4 PLACES ±---	±---	DRAWN BY	DATE	5:1	METRIC	
1		▽=0	3 PLACES ±0.10	±---	N. MCNAMA	2004/09/07			
			2 PLACES ±0.10	±---	CHECKED BY	DATE	2.5MM SIGNAL W/SIDE LATCHES (2.5 & 5MM TERM PITCH) MOLEX INCORPORATED		
			1 PLACE ±0.2	±---	JDENNEHY	2004/09/08			
			ANGULAR ± 2 °		APPROVED BY	DATE	SD-92339-001 SHEET NO. 1 OF 4		
			DRAFT WHERE APPLICABLE MUST REMAIN WITHIN DIMENSIONS		BMAGUIRE	2011/04/19			
					MATERIAL NO.		THIS DRAWING CONTAINS INFORMATION THAT IS PROPRIETARY TO MOLEX INCORPORATED AND SHOULD NOT BE USED WITHOUT WRITTEN PERMISSION		
					SEE SHEET 2-4				











2 CIRCUIT

MOLEX PART NO.	HOUSING PART NO.	TERMINAL VOID POSITION	REMOVED POSITION KEYS	CONFIGURATION (SEE NOTE 1)	POLARIZING RIB BETWEEN	COLOUR STRIPE
92339-9001	92340-0103	CCT 2	a d		CCT 1&2	NONE
92339-9002	92340-0203	CCT 2	a d		CCT 2&3	NONE
92339-9003	92340-0003	CCT 2	a d		NONE	NONE
92339-9004	92340-0103	CCT 2	a c d		CCT 1&2	RED
92339-9005	92340-0103	CCT 2	a b d		CCT 1&2	GREEN
92339-9006	92340-0203	CCT 2	a c d		CCT 2&3	BLUE
92339-9007	92340-0203	CCT 2	a b d		CCT 2&3	BLACK
92339-9008	92340-0103	CCT 2	a c d		CCT 1&2	NONE
92339-9009	92340-0203	CCT 2	a c d		CCT 2&3	NONE
92339-9010	92340-0203	CCT 2	a b d		CCT 2&3	NONE
92339-9011	92340-0103	CCT 2	a b d		CCT 1&2	NONE
92339-9013	92340-0103	CCT 2	a c d		CCT 1&2	BLUE
92339-9014	92340-0203	CCT 2	a d		CCT 2&3	GREEN
92339-9015	92340-0003	CCT 2	a c d		NONE	RED
92339-9016	92340-0003	CCT 2	a b d		NONE	GREEN







3 CIRCUIT

MOLEX PART NO.	HOUSING PART NO.	TERMINAL VOID POSITION	REMOVED POSITION KEYS	CONFIGURATION (SEE NOTE 1)	POLARIZING RIB BETWEEN	COLOUR STRIPE
92339-0001	92340-0103	NONE	a d		CCT 1&2	NONE
92339-0002	92340-0003	NONE	a c d		NONE	NONE
92339-0003	92340-0203	NONE	a d		CCT 2&3	NONE
92339-0004	92340-0103	NONE	a c d		CCT 1&2	NONE
92339-0005	92340-0103	NONE	a b d		CCT 1&2	NONE
92339-0006	92340-0203	NONE	a d		CCT 2&3	BLACK
92339-0007	92340-0103	NONE	a d		CCT 1&2	RED
92339-0008	92340-0103	CCT 2	a d		CCT 1&2	GREEN

4 CIRCUIT

MOLEX PART NO.	HOUSING PART NO.	TERMINAL VOID POSITION	REMOVED POSITION KEYS	CONFIGURATION (SEE NOTE 1)	POLARIZING RIB BETWEEN	COLOUR STRIPE
92339-0501	92340-0104	NONE	a e		CCT 1&2	NONE
92339-0502	92340-0004	NONE	a e		NONE	NONE
92339-0503	92340-0004	CCT 3	a b e		NONE	RED
92339-0504	92340-0004	NONE	a d e		NONE	BLACK
92339-0505	92340-0004	NONE	a d e		NONE	NONE
92339-0506	92340-0004	CCT 3	a b e		NONE	NONE
92339-0507	92340-0104	NONE	a e		CCT 1&2	BLACK
92339-0508	92340-0004	NONE	a e		NONE	RED
92339-0509	92340-0104	NONE	a c e		CCT 1&2	NONE
92339-0510	92340-0304	NONE	a e		CCT 3&4	NONE
92339-0511	92340-0004	CCT 3	NONE		NONE	GREEN

5 CIRCUIT

MOLEX PART NO.	HOUSING PART NO.	TERMINAL VOID POSITION	REMOVED POSITION KEYS	CONFIGURATION (SEE NOTE 1)	POLARIZING RIB BETWEEN	COLOUR STRIPE
92339-1001	92340-0205	NONE	a f		CCT 2&3	NONE
92339-1002	92340-0105	NONE	a f		CCT 1&2	NONE
92339-1003	92340-0205	NONE	a f		CCT 2&3	BLACK
92339-1004	92340-0105	CCT 4	a f		CCT 1&2	GREEN
92339-1005	92340-0305	NONE	a f		CCT 3&4	RED
92339-1006	92340-0305	CCT 2	a f		CCT 3&4	BLUE

- NOTES**
- 1. + DENOTES TERMINAL VOIDED POSITION
 - ⊙ DENOTES TERMINAL LOADED POSITION
 - | DENOTES POLARIZING RIB POSITION

SEE SHEET 1 ELEC NO: IPC2014-186 DRW: N.MCNAMEHAN CHKD: APPR: STIGRIFIN	QUALITY SYMBOLS ▽=0 ▽=0	GENERAL TOLERANCES (UNLESS SPECIFIED) mm INCH 4 PLACES ± --- ± --- 3 PLACES ± 0.10 ± --- 2 PLACES ± 0.10 ± --- 1 PLACE ± 0.2 ± --- ANGULAR ± 2°	DIMENSION STYLE MM ONLY	SCALE 1:1	DESIGN UNITS METRIC	THIRD ANGLE PROJECTION	
	DRAWN BY DATE N.MCNAMEHA 2004/09/07		CHECKED BY DATE J.DENEHY 2004/09/08		APPROVED BY DATE BMAGUIRE 2011/04/19		TITLE 2.5MM SIGNAL W/SIDE LATCHES (2.5 & 5MM TERM PITCH)
	DRAFT WHERE APPLICABLE MUST REMAIN WITHIN DIMENSIONS		SEE CHARTS		MATERIAL NO. DOCUMENT NO. SD-92339-001		
	THIS DRAWING CONTAINS INFORMATION THAT IS PROPRIETARY TO MOLEX INCORPORATED AND SHOULD NOT BE USED WITHOUT WRITTEN PERMISSION						SHEET NO. 2 OF 4

6 CIRCUIT						
MOLEX PART NO.	HOUSING PART NO.	TERMINAL VOID POSITION	REMOVED POSITION KEYS	CONFIGURATION (SEE NOTE 1)	POLARIZING RIB BETWEEN	COLOUR STRIPE
92339-1501	92340-0206	NONE	a g		CCT 2&3	NONE
92339-1502	92340-0506	NONE	a g		CCT 5&6	NONE
92339-1503	92340-0206	NONE	a g		CCT 2&3	BLACK
92339-1504	92340-0206	NONE	a g		CCT 2&3	BLUE
92339-1505	92340-0106	NONE	a g		CCT 1&2	NONE
92339-1506	92340-0406	NONE	a g		CCT 4&5	NONE
92339-1507	92340-0006	NONE	a g		NONE	NONE
92339-1508	92340-0406	CCT 3, 5	a g		CCT 4&5	GREEN
92339-1509	92340-0406	NONE	a g		CCT 4&5	RED

7 CIRCUIT						
MOLEX PART NO.	HOUSING PART NO.	TERMINAL VOID POSITION	REMOVED POSITION KEYS	CONFIGURATION (SEE NOTE 1)	POLARIZING RIB BETWEEN	COLOUR STRIPE
92339-2001	92340-2307	NONE	a h		CCT 1&2 & CCT 5&6	NONE
92339-2002	92340-0107	CCT 2	a h		CCT 1&2	NONE
92339-2003	92340-0207	NONE	a h		CCT 2&3	BLACK
92339-2004	92340-0507	NONE	a h		CCT 5&6	NONE
92339-2005	92340-0207	CCT 2&4	a h		CCT 2&3	NONE

8 CIRCUIT						
MOLEX PART NO.	HOUSING PART NO.	TERMINAL VOID POSITION	REMOVED POSITION KEYS	CONFIGURATION (SEE NOTE 1)	POLARIZING RIB BETWEEN	COLOUR STRIPE
92339-2501	92340-2408	NONE	a i		CCT 1&2 & CCT 6&7	NONE
92339-2502	92340-2408	CCT 2, 5	a i		CCT 1&2 & CCT 6&7	NONE
92339-2503	92340-2408	CCT 2	a i		CCT 1&2 & CCT 6&7	NONE
92339-2504	92340-0208	NONE	a i		CCT 2&3	NONE
92339-2505	92340-0208	CCT 2, 5	a i		CCT 2&3	NONE
92339-2506	92340-0108	NONE	a i		CCT 1&2	NONE
92339-2507	92340-0308	NONE	a i		CCT 3&4	NONE
92339-2508	92340-0308	NONE	a i		CCT 3&4	RED

NOTES
 1 + DENOTES TERMINAL VOIDED POSITION
 ⊕ DENOTES TERMINAL LOADED POSITION
 | DENOTES POLARIZING RIB POSITION

SEE SHEET 1 EC NO: IPG2014-1186 DRAWN BY: DRW:KONWAHAN CHKD: APPR:STRIGRIFFIN DATE: 2014/01/30	QUALITY SYMBOLS	GENERAL TOLERANCES (UNLESS SPECIFIED)	DIMENSION STYLE	SCALE	DESIGN UNITS	THIRD ANGLE PROJECTION	
	$\nabla=0$ $\nabla=0$	mm INCH 4 PLACES ± --- ± --- 3 PLACES ± 0.10 ± --- 2 PLACES ± 0.10 ± --- 1 PLACE ± 0.2 ± --- ANGULAR ± 2°	M M ONLY	DRAWN BY: N.MCNAMA DATE: 2004/09/07 CHECKED BY: J.DENNEHY DATE: 2004/09/08 APPROVED BY: B.MAGUIRE DATE: 2011/04/19	5:1	METRIC	TITLE: 2.5MM SIGNAL W/SIDE LATCHES (2.5 & 5MM TERM PITCH) MOLEX INCORPORATED
	DRAFT WHERE APPLICABLE MUST REMAIN WITHIN DIMENSIONS	SEE CHART	MATERIAL NO.	DOCUMENT NO.	SD-92339-001		SHEET NO. 3 OF 4
	THIS DRAWING CONTAINS INFORMATION THAT IS PROPRIETARY TO MOLEX INCORPORATED AND SHOULD NOT BE USED WITHOUT WRITTEN PERMISSION						

9 CIRCUIT

MOLEX PART NO.	HOUSING PART NO.	TERMINAL VOID POSITION	REMOVED POSITION KEYS	CONFIGURATION (SEE NOTE 1)	POLARIZING RIB BETWEEN	COLOUR STRIPE
92339-3001	92340-2509	NONE	a j		CCT 1&2 & CCT 7&8	NONE
92339-3426	92340-2509	CCT 2, 4, 6, 8	a j		CCT 1&2 & CCT 7&8	NONE
92339-3003	92340-0209	CCT 2	a j		CCT 2&3	GREEN
92339-3004	92340-0209	CCT 2, 4, 6	a j		CCT 2&3	BLACK
92339-3005 PART NUMBER OBSOLETE (NO GREY STRIPE AVAILABLE)						
92339-3006	92340-0209	None	a j		CCT 2&3	BLACK
92339-3007	92340-0209	CCT 3, 5, 7	a j		CCT 2&3	GREEN
92339-3008 PART NUMBER OBSOLETE (NO GREY STRIPE AVAILABLE)						
92339-3009	92340-0209	CCT 3, 5, 8	a j		CCT 2&3	GREEN
92339-3010	92340-0409	CCT 3, 5, 7	a j		CCT 4&5	RED

12 CIRCUIT

MOLEX PART NO.	HOUSING PART NO.	TERMINAL VOID POSITION	REMOVED POSITION KEYS	CONFIGURATION (SEE NOTE 1)	POLARIZING RIB BETWEEN	COLOUR STRIPE
92339-4501	92340-2812	NONE	a m		CCT 1&2 & CCT 10&11	NONE
92339-4502	92340-2812	CCT 2, 5, 8, 10	a m		CCT 1&2 & CCT 10&11	NONE
92339-4503	92340-0212	NONE	a m		CCT 2&3	NONE
92339-4504	92340-0212	CCT 2, 5, 8, 10	a m		CCT 2&3	NONE
92339-4505	92340-0212	NONE	a m		CCT 2&3	BLACK
92339-4506	92340-1112	NONE	a m		CCT 11&12	NONE

14 CIRCUIT

MOLEX PART NO.	HOUSING PART NO.	TERMINAL VOID POSITION	REMOVED POSITION KEYS	CONFIGURATION (SEE NOTE 1)	POLARIZING RIB BETWEEN	COLOUR STRIPE
92339-5501	92340-3014	NONE	a o		CCT 1&2 & CCT 12&13	NONE

15 CIRCUIT

MOLEX PART NO.	HOUSING PART NO.	TERMINAL VOID POSITION	REMOVED POSITION KEYS	CONFIGURATION (SEE NOTE 1)	POLARIZING RIB BETWEEN	COLOUR STRIPE
92339-6001	92340-3115	NONE	a p		CCT 1&2 & CCT 13&14	NONE
92339-6426	92340-3115	CCT 2, 4, 6, 8, 10, 12, 14	a p		CCT 1&2 & CCT 13&14	NONE

16 CIRCUIT

MOLEX PART NO.	HOUSING PART NO.	TERMINAL VOID POSITION	REMOVED POSITION KEYS	CONFIGURATION (SEE NOTE 1)	POLARIZING RIB BETWEEN	COLOUR STRIPE
92339-6501	92340-3216	NONE	a q		CCT 1&2 & CCT 14&15	NONE

17 CIRCUIT

MOLEX PART NO.	HOUSING PART NO.	TERMINAL VOID POSITION	REMOVED POSITION KEYS	CONFIGURATION (SEE NOTE 1)	POLARIZING RIB BETWEEN	COLOUR STRIPE
92339-7001	92340-3317	NONE	a r		CCT 1&2 & CCT 15&16	NONE
92339-7002	92340-6617	CCT 2, 4, 5, 6, 8, 10, 12, 14, 16,	a r		CCT 3&4 & CCT 15&16	NONE

13 CIRCUIT

MOLEX PART NO.	HOUSING PART NO.	TERMINAL VOID POSITION	REMOVED POSITION KEYS	CONFIGURATION (SEE NOTE 1)	POLARIZING RIB BETWEEN	COLOUR STRIPE
92339-5001	92340-2913	NONE	a n		CCT 1&2 & CCT 11&12	NONE

18 CIRCUIT

MOLEX PART NO.	HOUSING PART NO.	TERMINAL VOID POSITION	REMOVED POSITION KEYS	CONFIGURATION (SEE NOTE 1)	POLARIZING RIB BETWEEN	COLOUR STRIPE
92339-7501	92340-3418	NONE	a s		CCT 1&2 & CCT 16&17	NONE

10 CIRCUIT

MOLEX PART NO.	HOUSING PART NO.	TERMINAL VOID POSITION	REMOVED POSITION KEYS	CONFIGURATION (SEE NOTE 1)	POLARIZING RIB BETWEEN	COLOUR STRIPE
92339-3501	92340-2610	NONE	a k		CCT 1&2 & CCT 8&9	NONE
92339-3502	92340-0910	NONE	a k		CCT 9&10	RED
92339-3503	92340-0910	NONE	a k		CCT 9&10	NONE
92339-3504	92340-0210	NONE	a k		CCT 2&3	NONE
92339-3505	92340-0210	NONE	a k		CCT 2&3	BLACK

19 CIRCUIT

MOLEX PART NO.	HOUSING PART NO.	TERMINAL VOID POSITION	REMOVED POSITION KEYS	CONFIGURATION (SEE NOTE 1)	POLARIZING RIB BETWEEN	COLOUR STRIPE
92339-8001	92340-3519	NONE	a t		CCT 1&2 & CCT 17&18	NONE

20 CIRCUIT

MOLEX PART NO.	HOUSING PART NO.	TERMINAL VOID POSITION	REMOVED POSITION KEYS	CONFIGURATION (SEE NOTE 1)	POLARIZING RIB BETWEEN	COLOUR STRIPE
92339-8501	92340-3620	NONE	a u		CCT 1&2 & CCT 18&19	NONE

11 CIRCUIT

MOLEX PART NO.	HOUSING PART NO.	TERMINAL VOID POSITION	REMOVED POSITION KEYS	CONFIGURATION (SEE NOTE 1)	POLARIZING RIB BETWEEN	COLOUR STRIPE
92339-4001	92340-2711	NONE	a l		CCT 1&2 & CCT 9&10	NONE

- NOTES**
- 1 + DENOTES TERMINAL VOIDED POSITION
 - ⊙ DENOTES TERMINAL LOADED POSITION
 - | DENOTES POLARIZING RIB POSITION

SEE SHEET 1 IEC NO: IFC2014-1186 G DRWINGKONWANH CHKD: APPR:STGRIFFIN REV	QUALITY SYMBOLS	GENERAL TOLERANCES (UNLESS SPECIFIED)	DIMENSION STYLE	SCALE	DESIGN UNITS	THIRD ANGLE PROJECTION
	▽=0 ▽=0	mm INCH 4 PLACES ± --- ± --- 3 PLACES ± 0.10 ± --- 2 PLACES ± 0.10 ± --- 1 PLACE ± 0.2 ± --- ANGULAR ± 2°	MM ONLY DRAWN BY DATE N. MCNAMA 2004/09/07 CHECKED BY DATE J DENNEHY 2004/09/08 APPROVED BY DATE BMAGUIRE 2011/04/19	1:1	METRIC	TITLE 2.5MM SIGNAL W/SIDE LATCHES (2.5 & 5MM TERM PITCH)
	DRAFT WHERE APPLICABLE MUST REMAIN WITHIN DIMENSIONS	SEE CHARTS MATERIAL NO. THIS DRAWING CONTAINS INFORMATION THAT IS PROPRIETARY TO MOLEX INCORPORATED AND SHOULD NOT BE USED WITHOUT WRITTEN PERMISSION	MOLEX INCORPORATED DOCUMENT NO. SD-92339-001	SHEET NO. 4 OF 4		