

ODU MINI-SNAP® Series K Plug acc. IEC 60601-1

General information

Part number	SB2KAC-P12PFG2-750S
Termination	Crimp
Size	2
Locking principle	push
Coding	a_key
Cable Diameter	cable_mini_75
Cable outlet	bend_relief
customs tariff numbers	85366990

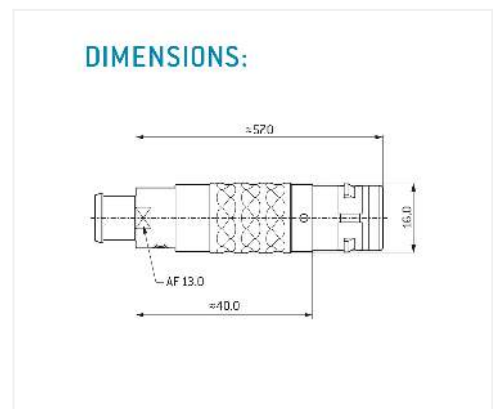
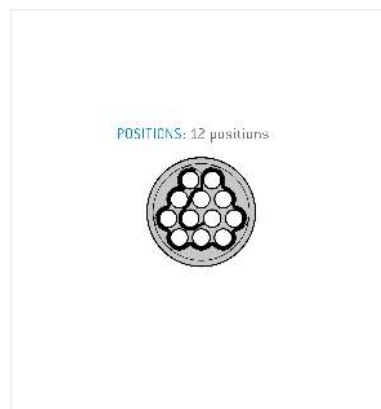

Contact insert description

Number of contacts	12
Contact type	pins
Contact diameter	07mm
Insulator material	peek
Wire cross section	22-26 AWG
Termination	Crimp

Technical information

Max. creepage and air clearance distance	12_mm	2_moop
Nominal current single contact	075_a	iec_60512_5_2
Nominal current insert	4,1 A	vde_0298_13
Test voltage	12_kv_ac	sae_13441

safety_text

Mechanical and environmental data

Degree of protection*	ip68
-----------------------	------

Operating temperature	40_120_c
-----------------------	----------

Mating cycles	5000
---------------	------

mated

Material and surface treatments

Housing	chrome_finish
---------	---------------

Contact	cu_alloy_gold
---------	---------------

safety_text_2

ul_text

illustrative_text