

FEATURES

- Matched pair of programmable filters and VGAs**
- Continuous gain control range: 50 dB**
- Digital gain control: 15 dB**
- 6-pole Butterworth filter: 1 MHz to 31 MHz**
in 1 MHz steps, 1 dB corner frequency
- Preamplifier and postamplifier gain steps**
- IMD3: >65 dBc for 1.5 V p-p composite output**
- HD2, HD3: >65 dBc for 1.5 V p-p output**
- Differential input and output**
- Flexible output and input common-mode ranges**
- Optional dc offset compensation loop**
- SPI programmable filter corners and gain steps**
- Power-down feature**
- Single 3.3 V supply operation**

APPLICATIONS

- Baseband IQ receivers**
- Diversity receivers**
- ADC drivers**
- Point-to-point and point-to-multipoint radio**
- Instrumentation**
- Medical**

GENERAL DESCRIPTION

The [ADRF6516](#) is a matched pair of fully differential, low noise and low distortion programmable filters and variable gain amplifiers (VGAs). Each channel is capable of rejecting large out-of-band interferers while reliably boosting the desired signal, thus reducing the bandwidth and resolution requirements on the analog-to-digital converters (ADCs). The excellent matching between channels and their high spurious-free dynamic range over all gain and bandwidth settings make the [ADRF6516](#) ideal for quadrature-based (IQ) communication systems with dense constellations, multiple carriers, and nearby interferers.

The filters provide a six-pole Butterworth response with 1 dB corner frequencies programmable through the SPI port from 1 MHz to 31 MHz in 1 MHz steps. The preamplifier that precedes the filters offers a SPI-programmable option of either 3 dB or 6 dB of gain. The preamplifier sets a differential input impedance of 1600 Ω and has a common-mode voltage that defaults to $V_{PS}/2$ but can be driven from 1.1 V to 1.8 V.

FUNCTIONAL BLOCK DIAGRAM

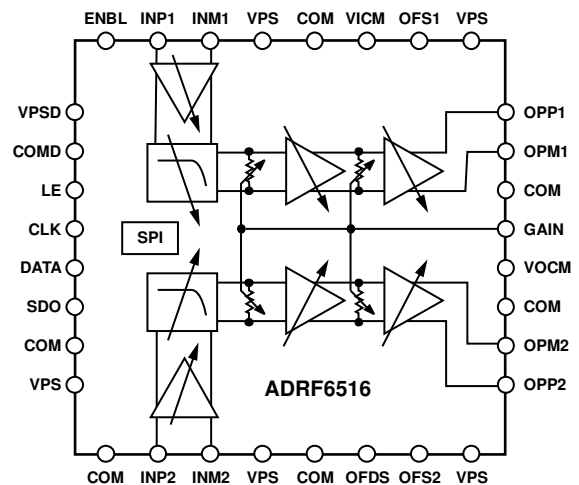

Figure 1.

08442-001

The variable gain amplifiers that follow the filters provide 50 dB of continuous gain control with a slope of 15.5 mV/dB. Their maximum gains can be programmed to various values through the SPI. The output buffers provide a differential output impedance of 30 Ω and are capable of driving 2 V p-p into 1 k Ω loads. The output common-mode voltage defaults to $V_{PS}/2$, but it can be adjusted down to 700 mV by driving the high impedance VOCM pin. Independent, built-in dc offset compensation loops can be disabled if fully dc-coupled operation is desired. The high-pass corner frequency is defined by external capacitors on the OFS1 and OFS2 pins and the VGA gain.

The [ADRF6516](#) operates from a 3.15 V to 3.45 V supply and consumes a maximum supply current of 360 mA when programmed to the highest bandwidth setting. When disabled, it consumes <9 mA. The [ADRF6516](#) is fabricated in an advanced silicon-germanium BiCMOS process and is available in a 32-lead, exposed paddle LFCSP. Performance is specified over the -40°C to $+85^{\circ}\text{C}$ temperature range.

Rev. C

[Document Feedback](#)

Information furnished by Analog Devices is believed to be accurate and reliable. However, no responsibility is assumed by Analog Devices for its use, nor for any infringements of patents or other rights of third parties that may result from its use. Specifications subject to change without notice. No license is granted by implication or otherwise under any patent or patent rights of Analog Devices. Trademarks and registered trademarks are the property of their respective owners.

TABLE OF CONTENTS

Features	1	Maximizing the Dynamic Range.....	19
Applications.....	1	Key Parameters for Quadrature-Based Receivers	20
Functional Block Diagram	1	Applications Information	21
General Description	1	Basic Connections.....	21
Revision History	2	Supply Decoupling	21
Specifications.....	3	Input Signal Path	21
Timing Diagrams.....	5	Output Signal Path	21
Absolute Maximum Ratings.....	6	DC Offset Compensation Loop Enabled	21
ESD Caution.....	6	Common-Mode Bypassing	21
Pin Configuration and Function Descriptions.....	7	Serial Port Connections.....	22
Typical Performance Characteristics	8	Enable/Disable Function	22
Register Map and Codes.....	15	Error Vector Magnitude (EVM) Performance.....	22
Theory of Operation	16	EVM Test Setup	22
Input Buffers	16	Effect of Filter Bandwidth on EVM	22
Programmable Filters.....	16	Effect of Output Voltage Levels on EVM	23
Variable Gain Amplifiers (VGAs)	17	Effect of C _{OFS} Value on EVM.....	23
Output Buffers/ADC Drivers	17	Evaluation Board	24
DC Offset Compensation Loop.....	17	Evaluation Board Control Software	24
Programming the Filters and Gains.....	18	Schematics and Artwork	25
Noise Characteristics	18	Outline Dimensions	29
Distortion Characteristics	19	Ordering Guide	29

REVISION HISTORY

8/2017—Rev. B to Rev. C

Change to Figure 4	7
Updated Outline Dimensions	29
Changes to Ordering Guide Section	29

2/2012—Rev. A to Rev. B

Changes to Figure 57	24
Changes to Figure 58.....	25
Added Figure 59.....	26
Changes to Figure 60 and Figure 61	27
Changes to Table 6.....	27

9/2011—Revision A: Initial Version

SPECIFICATIONS

VPS = 3.3 V, T_A = 25°C, Z_{LOAD} = 1 kΩ, digital gain code = 111, unless otherwise noted.

Table 1.

Parameter	Test Conditions/Comments	Min	Typ	Max	Unit
FREQUENCY RESPONSE					
Low-Pass Corner Frequency, f _c	6-pole Butterworth filter, 0.5 dB bandwidth	1		31	MHz
Step Size			1		MHz
Corner Frequency Absolute Accuracy	Over operating temperature range		±15		% f _c
Corner Frequency Matching	Channel A and Channel B at same gain and bandwidth settings		±0.5		% f _c
Pass-Band Ripple			0.5		dB p-p
Gain Matching	Channel A and Channel B at same gain and bandwidth settings		±0.1		dB
Group Delay Variation	From midband to peak				
Corner Frequency = 1 MHz			135		ns
Corner Frequency = 31 MHz			11		ns
Group Delay Matching	Channel A and Channel B at same gain				
Corner Frequency = 1 MHz			5		ns
Corner Frequency = 31 MHz			0.2		ns
Stop-Band Rejection					
Relative to Pass Band	2 × f _c		30		dB
	5 × f _c		75		dB
INPUT STAGE					
Maximum Input Swing	INP1, INM1, INP2, INM2, VICM pins		1		V p-p
Differential Input Impedance	At minimum gain, V _{GAIN} = 0 V		1600		Ω
Input Common-Mode Range	0.4 V p-p input voltage, HD3 > 65 dBc	1.1	1.65	1.8	V
	Input pins left floating		VPS/2		V
VICM Output Impedance			7		kΩ
GAIN CONTROL					
Voltage Gain Range	GAIN pin	−5		+45	dB
Gain Slope	V _{GAIN} from 0 V to 1 V		15.5		mV/dB
Gain Error	V _{GAIN} from 300 mV to 800 mV		0.2		dB
OUTPUT STAGE					
Maximum Output Swing	OPP1, OPM1, OPP2, OPM2, VOCM pins		2		V p-p
	At maximum gain, R _{LOAD} = 1 kΩ		1.5		V p-p
	HD2 > 65 dBc, HD3 > 65 dBc		30		Ω
Differential Output Impedance			35		mV
Output DC Offset	Inputs shorted, offset loop disabled		0.7	2.8	V
Output Common-Mode Range	VOCM pin left floating		VPS/2		V
VOCM Input Impedance			23		kΩ
NOISE/DISTORTION					
Corner Frequency = 1 MHz					
Output Noise Density	Gain = 0 dB at f _c /2		−141		dBV/√Hz
	Gain = 20 dB at f _c /2		−131		dBV/√Hz
	Gain = 40 dB at f _c /2		−112		dBV/√Hz
Second Harmonic, HD2	250 kHz fundamental, 1.5 V p-p output voltage				
	Gain = 5 dB		82		dBc
	Gain = 40 dB		68		dBc
Third Harmonic, HD3	250 kHz fundamental, 1.5 V p-p output voltage				
	Gain = 5 dB		71		dBc
	Gain = 40 dB		56		dBc

Parameter	Test Conditions/Comments	Min	Typ	Max	Unit
IMD3	f1 = 500 kHz, f2 = 550 kHz, 1.5 V p-p composite output voltage Gain = 5 dB Gain = 35 dB		61 42.5		dBc dBc
IMD3 with Input CW Blocker	f1 = 500 kHz, f2 = 550 kHz, 1.5 V p-p composite output, gain = 5 dB; blocker at 5 MHz, 10 dBc relative to two-tone composite output voltage		40		dBc
Corner Frequency = 31 MHz Output Noise Density	Midband, gain = 0 dB Midband, gain = 20 dB Midband, gain = 40 dB		-143.5 -139 -125		dBV/ $\sqrt{\text{Hz}}$ dBV/ $\sqrt{\text{Hz}}$ dBV/ $\sqrt{\text{Hz}}$
Second Harmonic, HD2	8 MHz fundamental, 1.5 V p-p output voltage Gain = 5 dB Gain = 40 dB		68 70		dBc dBc
Third Harmonic, HD3	8 MHz fundamental, 1.5 V p-p output voltage Gain = 5 dB Gain = 40 dB		55 75		dBc dBc
IMD3	f1 = 14 MHz, f2 = 15 MHz, 1.5 V p-p composite output voltage Gain = 5 dB Gain = 35 dB		55 77.5		dBc dBc
IMD3 with Input CW Blocker	f1 = 14 MHz, f2 = 15 MHz, 1.5 V p-p composite output, gain = 5 dB; blocker at 150 MHz, 10 dBc relative to two-tone composite output voltage		55		dBc
DIGITAL LOGIC	LE, CLK, DATA, SDO, OFDS pins				
Input High Voltage, V_{INH}			>2		V
Input Low Voltage, V_{INL}			<0.8		V
Input Current, $I_{\text{INH}}/I_{\text{INL}}$			<1		μA
Input Capacitance, C_{IN}			2		pF
SPI TIMING	LE, CLK, DATA, SDO pins (see Figure 2 and Figure 3)				
f_{SCLK}	$1/t_{\text{SCLK}}$		20		MHz
t_{DH}	DATA hold time		5		ns
t_{DS}	DATA setup time		5		ns
t_{LH}	LE hold time		5		ns
t_{LS}	LE setup time		5		ns
t_{PW}	CLK high pulse width		5		ns
t_{D}	CLK to SDO delay		5		ns
POWER AND ENABLE	VPS, VPSD, COM, COMD, ENBL pins				
Supply Voltage Range		3.15	3.3	3.45	V
Total Supply Current	ENBL = 3.3 V Corner frequency = 31 MHz Corner frequency = 1 MHz		360 330		mA mA
Disable Current	ENBL = 0 V		9		mA
Disable Threshold			1.6		V
Enable Response Time	Delay following ENBL low-to-high transition		20		μs
Disable Response Time	Delay following ENBL high-to-low transition		300		ns

TIMING DIAGRAMS

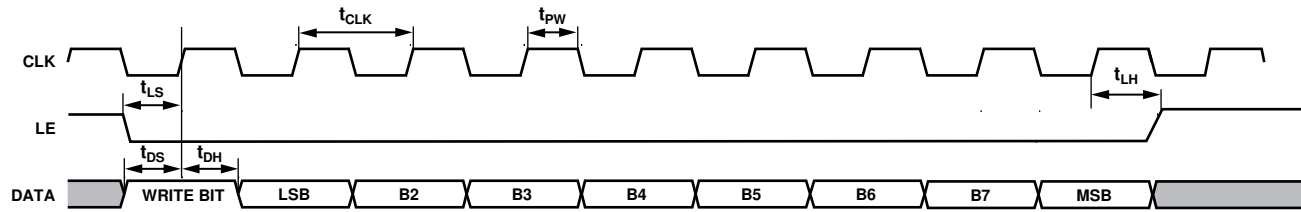

NOTES

1. THE FIRST DATA BIT DETERMINES WHETHER THE PART IS WRITING TO OR READING FROM THE INTERNAL 8-BIT REGISTER. FOR A WRITE OPERATION, THE FIRST BIT SHOULD BE A LOGIC 1. THE 8-BIT WORD IS THEN WRITTEN TO THE DATA PIN ON CONSECUTIVE RISING EDGES OF THE CLOCK.

Figure 2. Write Mode Timing Diagram

09422-003

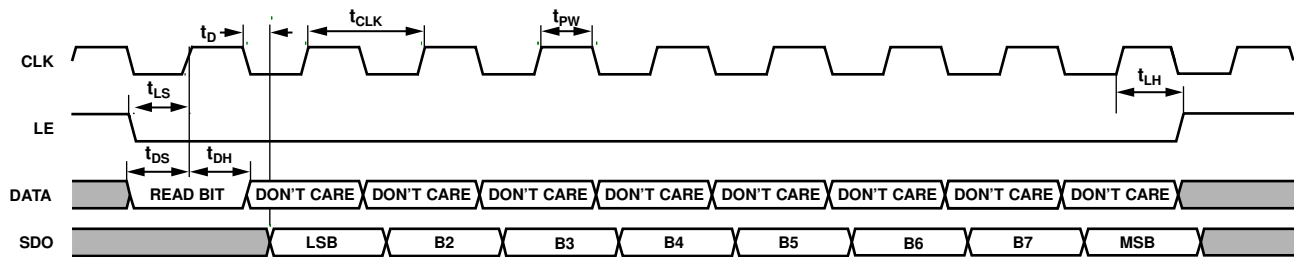

NOTES

1. THE FIRST DATA BIT DETERMINES WHETHER THE PART IS WRITING TO OR READING FROM THE INTERNAL 8-BIT REGISTER. FOR A READ OPERATION, THE FIRST BIT SHOULD BE A LOGIC 0. THE 8-BIT WORD IS THEN REGISTERED AT THE SDO PIN ON CONSECUTIVE FALLING EDGES OF THE CLOCK.

Figure 3. Read Mode Timing Diagram

09422-004

ABSOLUTE MAXIMUM RATINGS

Table 2.

Parameter	Rating
Supply Voltages, VPS, VPSD	3.45 V
ENBL, OFDS, LE, CLK, DATA, SDO	VPSD + 0.5 V
INP1, INM1, INP2, INM2	VPS + 0.5 V
OPP1, OPM1, OPP2, OPM2	VPS + 0.5 V
OFS1, OFS2	VPS + 0.5 V
GAIN	VPS + 0.5 V
Internal Power Dissipation	1.25 W
θ_{JA} (Exposed Pad Soldered to Board)	37.4°C/W
Maximum Junction Temperature	150°C
Operating Temperature Range	-40°C to +85°C
Storage Temperature Range	-65°C to +150°C
Lead Temperature (Soldering 60 sec)	300°C

Stresses at or above those listed under Absolute Maximum Ratings may cause permanent damage to the product. This is a stress rating only; functional operation of the product at these or any other conditions above those indicated in the operational section of this specification is not implied. Operation beyond the maximum operating conditions for extended periods may affect product reliability.

ESD CAUTION



ESD (electrostatic discharge) sensitive device. Charged devices and circuit boards can discharge without detection. Although this product features patented or proprietary protection circuitry, damage may occur on devices subjected to high energy ESD. Therefore, proper ESD precautions should be taken to avoid performance degradation or loss of functionality.

PIN CONFIGURATION AND FUNCTION DESCRIPTIONS

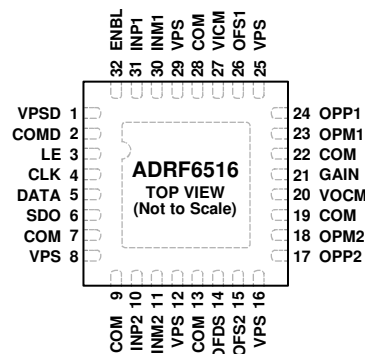

NOTES
1. CONNECT THE EXPOSED PADDLE TO A LOW IMPEDANCE GROUND PAD.

09442-002

Figure 4. Pin Configuration

Table 3. Pin Function Descriptions

Pin No.	Mnemonic	Description
1	VPSD	Digital Positive Supply Voltage: 3.15 V to 3.45 V.
2	COMD	Digital Common. Connect to external circuit common using the lowest possible impedance.
3	LE	Latch Enable. SPI programming pin. TTL levels: $V_{LOW} < 0.8 V$, $V_{HIGH} > 2 V$.
4	CLK	SPI Port Clock. TTL levels: $V_{LOW} < 0.8 V$, $V_{HIGH} > 2 V$.
5	DATA	SPI Data Input. TTL levels: $V_{LOW} < 0.8 V$, $V_{HIGH} > 2 V$.
6	SDO	SPI Data Output. TTL levels: $V_{LOW} < 0.8 V$, $V_{HIGH} > 2 V$.
7, 9, 13, 19, 22, 28	COM	Analog Common. Connect to external circuit common using the lowest possible impedance.
8, 12, 16, 25, 29	VPS	Analog Positive Supply Voltage: 3.15 V to 3.45 V.
10, 11, 30, 31	INP2, INM2, INM1, INP1	Differential Inputs. 1600 Ω input impedance.
14	OFDS	Offset Compensation Loop Disable. Pull high to disable the offset compensation loop.
15, 26	OFS2, OFS1	Offset Compensation Loop Capacitors. Connect capacitors to circuit common.
17, 18, 23, 24	OPP2, OPM2, OPM1, OPP1	Differential Outputs. 30 Ω output impedance. Common-mode range is 0.7 V to 2.8 V; default is $VPS/2$.
20	VOVM	Output Common-Mode Setpoint. Defaults to $VPS/2$ if left floating.
21	GAIN	Analog Gain Control. 0 V to 1 V, 15.5 mV/dB gain scaling.
27	VICM	Input Common-Mode Voltage. $VPS/2 V$ reference. Use to reference the optimal common-mode drive to the differential inputs.
32	ENBL	Chip Enable. Pull high to enable.
	EP	Exposed Paddle. Connect the exposed paddle to a low impedance ground pad.

TYPICAL PERFORMANCE CHARACTERISTICS

VPS = 3.3 V, T_A = 25°C, Z_{LOAD} = 1 kΩ, digital gain code = 111, unless otherwise noted.

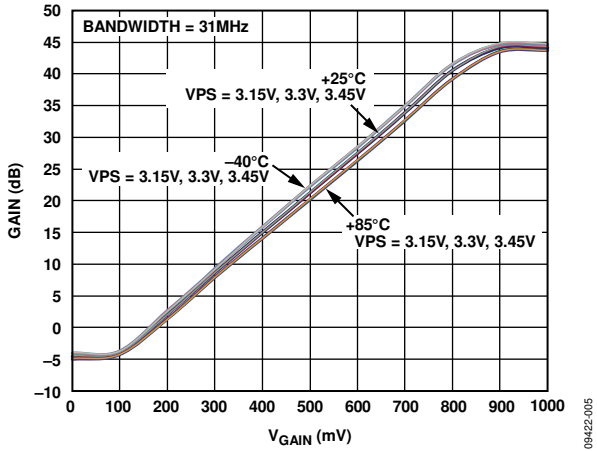

Figure 5. In-Band Gain vs. V_{GAIN} Over Supply and Temperature (Bandwidth Setting = 31 MHz)

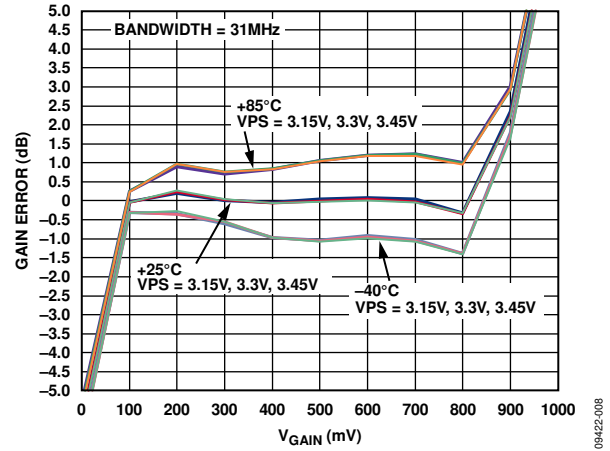

Figure 8. Gain Conformance vs. V_{GAIN} Over Supply and Temperature (Bandwidth Setting = 31 MHz)

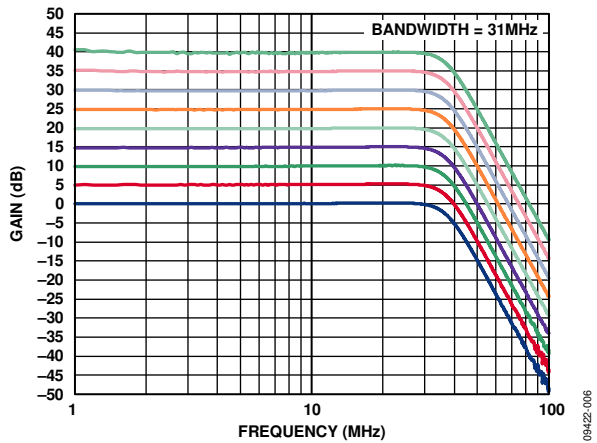

Figure 6. Gain vs. Frequency over V_{GAIN} (Bandwidth Setting = 31 MHz)

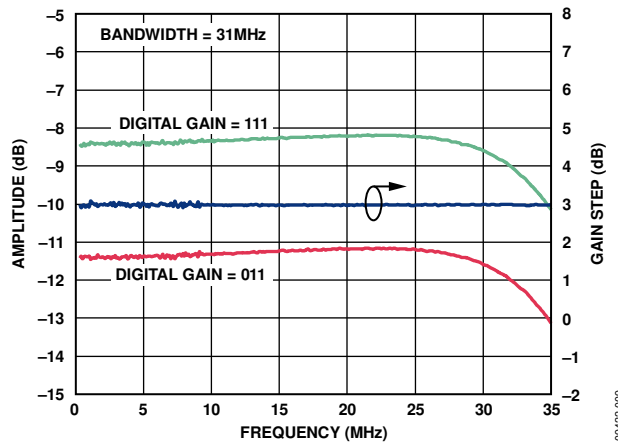

Figure 9. Gain Step and Gain Error vs. Frequency (Bandwidth Setting = 31 MHz, V_{GAIN} = 0 V)

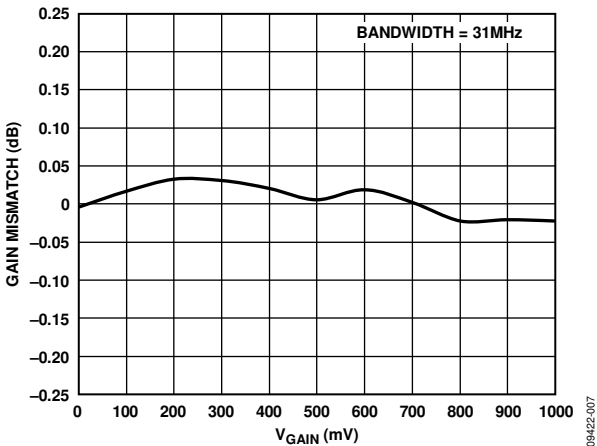

Figure 7. Gain Matching vs. V_{GAIN} (Bandwidth Setting = 31 MHz)

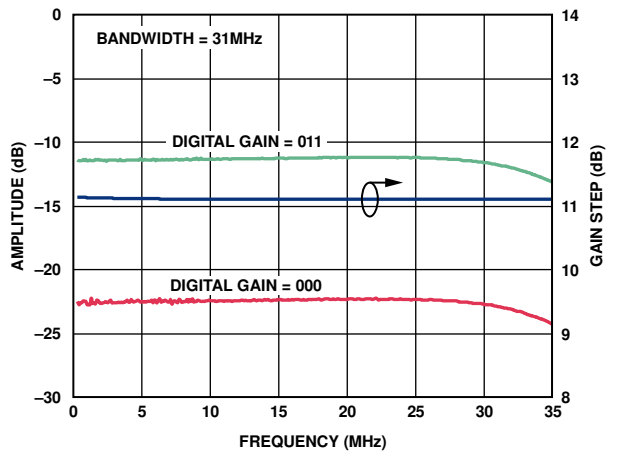

Figure 10. Gain Step and Gain Error vs. Frequency (Bandwidth Setting = 31 MHz, V_{GAIN} = 0 V)

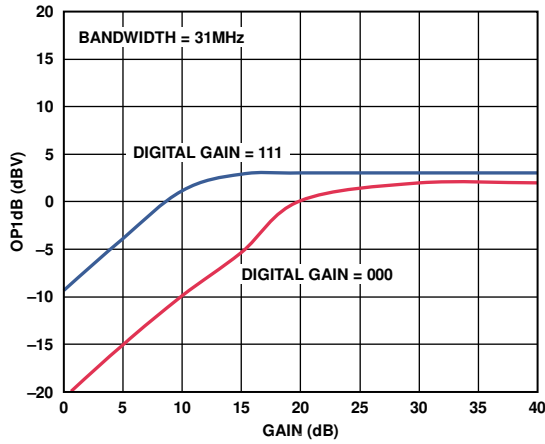

Figure 11. Output P1dB vs. Gain at 15 MHz (Bandwidth Setting = 31 MHz)

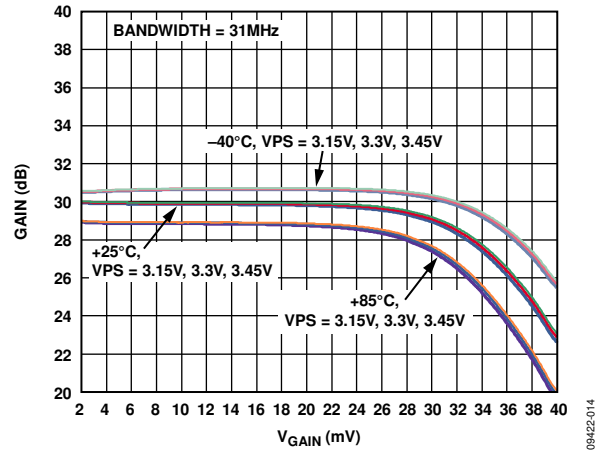

Figure 14. Frequency Response over Supply and Temperature (Bandwidth Setting = 31 MHz, Gain = 30 dB)

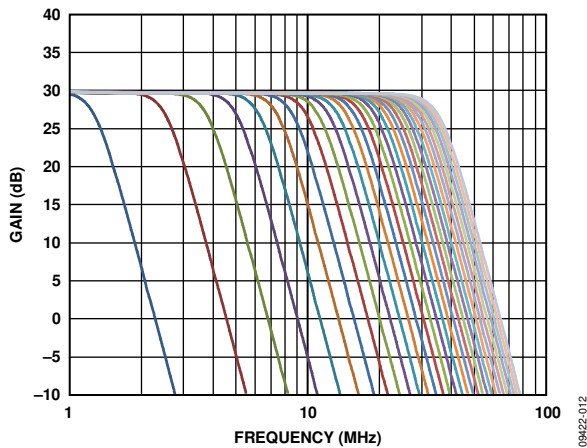

Figure 12. Frequency Response vs. Bandwidth Setting (Gain = 30 dB), Log Scale

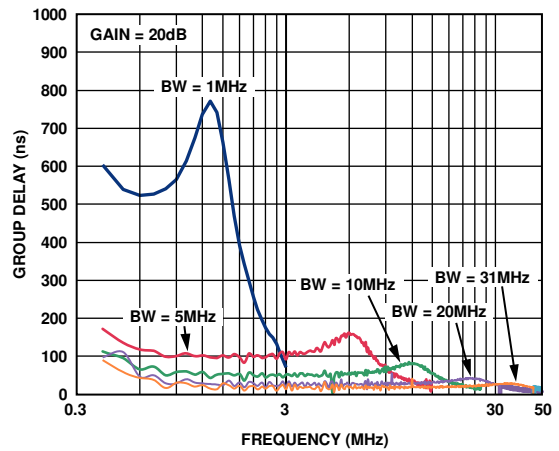

Figure 15. Group Delay vs. Frequency (Gain = 20 dB)

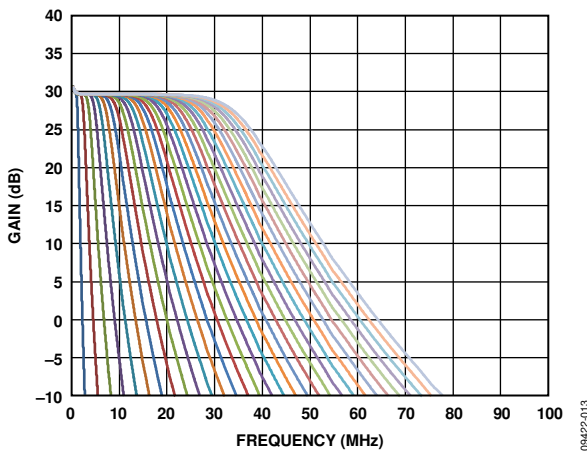

Figure 13. Frequency Response vs. Bandwidth Setting (Gain = 30 dB), Linear Scale

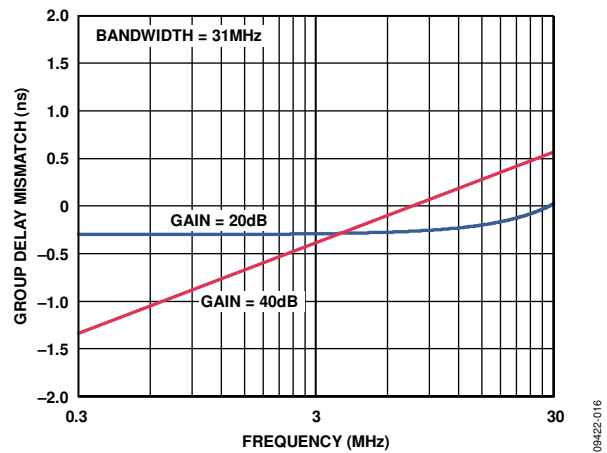

Figure 16. Group Delay Matching vs. Frequency (Bandwidth Setting = 31 MHz)

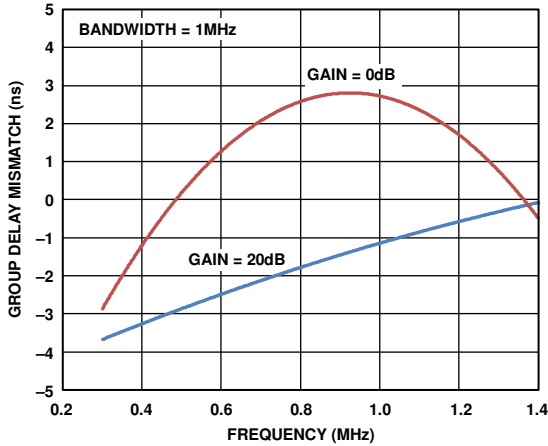

Figure 17. IQ Group Delay Matching vs. Frequency (Bandwidth Setting = 1 MHz)

09422-017

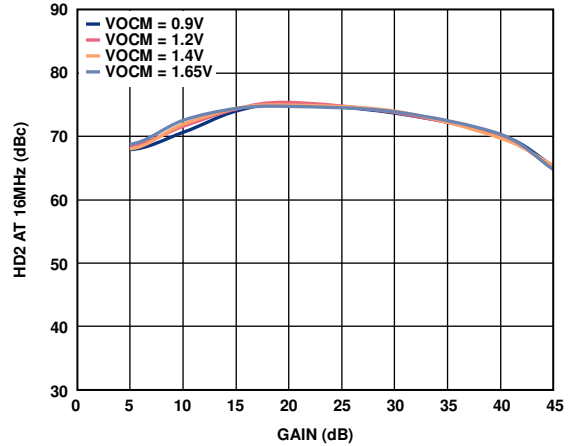

Figure 20. HD2 vs. Gain over Output Common-Mode Voltage (Bandwidth Setting = 31 MHz, 1.5 V p-p, 8 MHz CW Fundamental Output)

09422-020

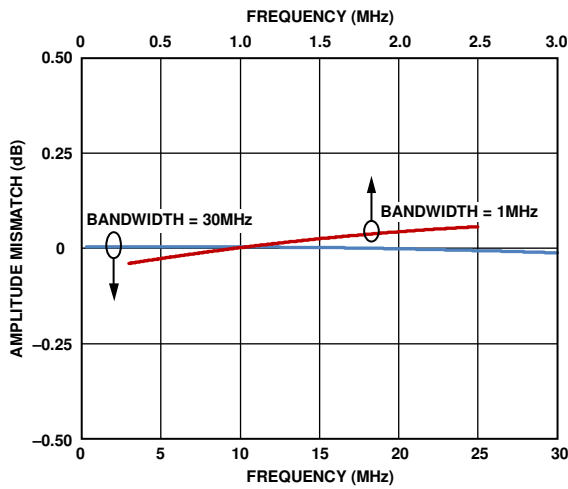

Figure 18. IQ Amplitude Matching vs. Frequency

09422-018

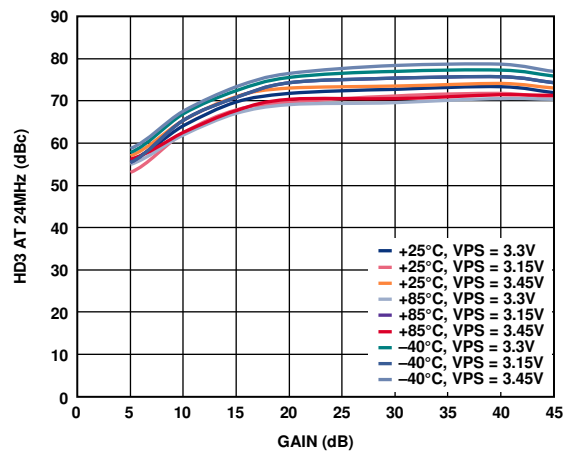

Figure 21. HD3 vs. Gain over Supply and Temperature (Bandwidth Setting = 31 MHz, 1.5 V p-p, 8 MHz CW Fundamental Output)

09422-022

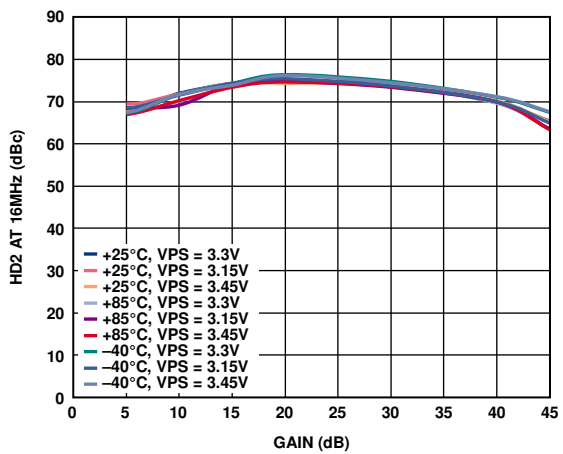

Figure 19. HD2 vs. Gain over Supply and Temperature (Bandwidth Setting = 31 MHz, 1.5 V p-p, 8 MHz CW Fundamental Output)

09422-019

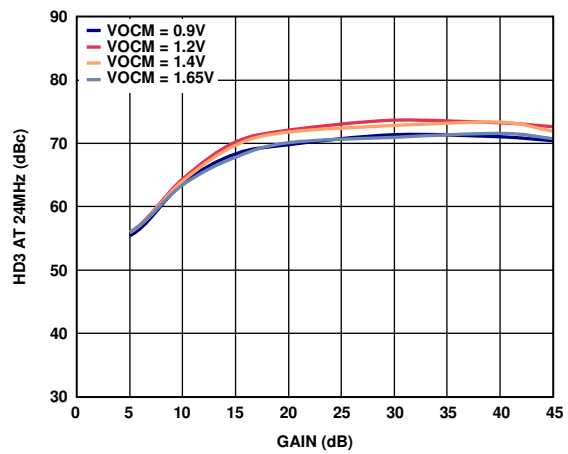

Figure 22. HD3 vs. Gain over Output Common-Mode Voltage (Bandwidth Setting = 31 MHz, 1.5 V p-p, 8 MHz CW Fundamental Output)

09422-023

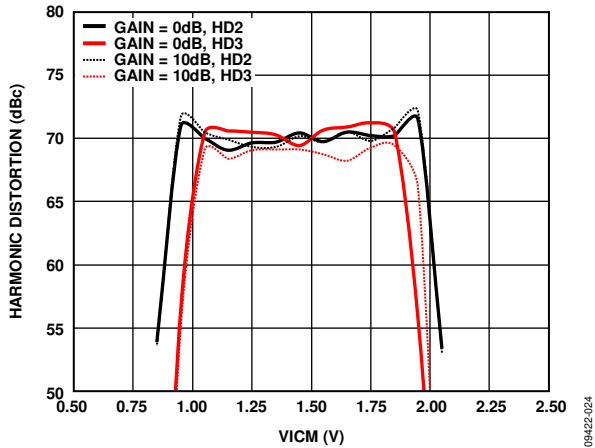

Figure 23. HD2 and HD3 vs. Input Common-Mode Voltage (Bandwidth Setting = 31 MHz, 0.4 V p-p Input Level)

09422-024

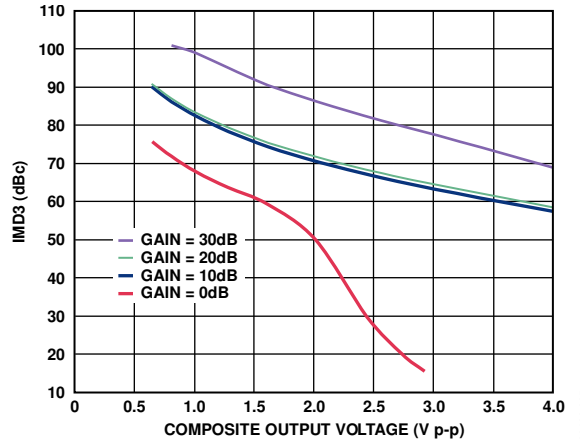

Figure 26. In-Band Third-Order Intermodulation Distortion (Bandwidth Setting = 31 MHz, Digital Gain = 000)

09422-027

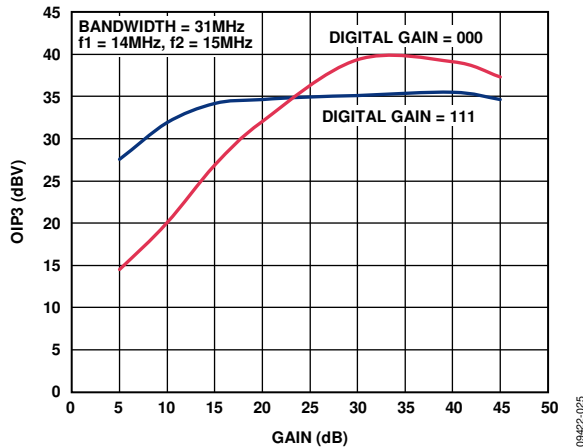

Figure 24. In-Band OIP3 vs. Gain (Bandwidth Setting = 31 MHz)

09422-025

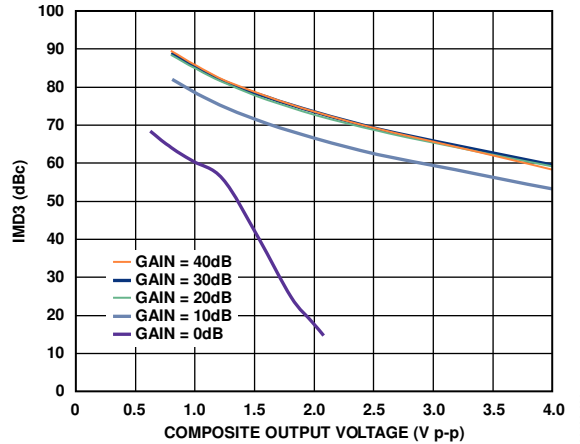

Figure 27. In-Band Third-Order Intermodulation Distortion (Bandwidth Setting = 31 MHz, Digital Gain = 111)

09422-028

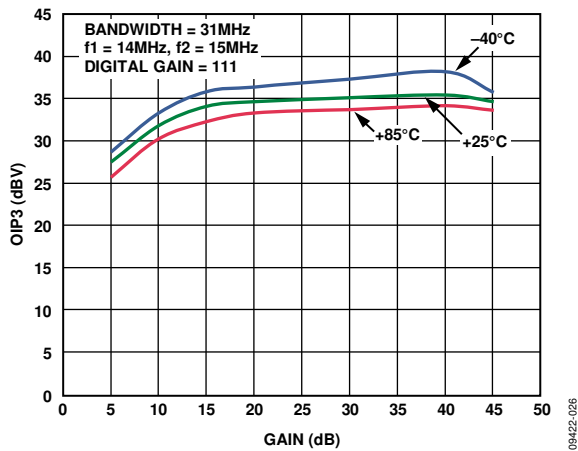

Figure 25. In-Band OIP3 vs. Gain over Temperature (Bandwidth Setting = 31 MHz)

09422-026

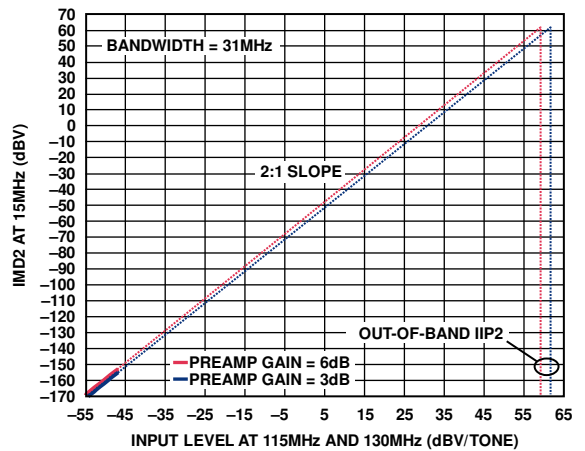

Figure 28. Out-of-Band IIP2, IMD2 Tone at Midband (Bandwidth Setting = 31 MHz)

09422-029

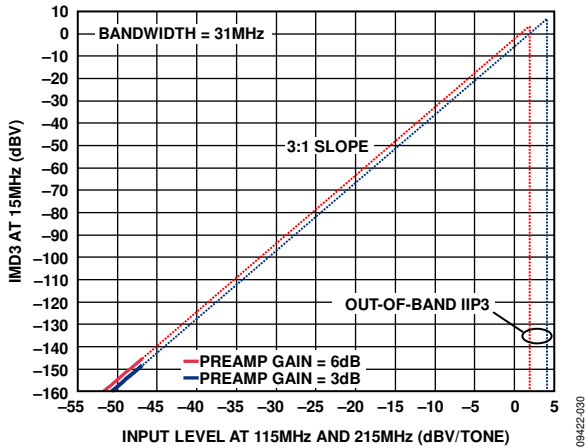

Figure 29. Out-of-Band IIP3, IMD3 Tone at Midband (Bandwidth Setting = 31 MHz)

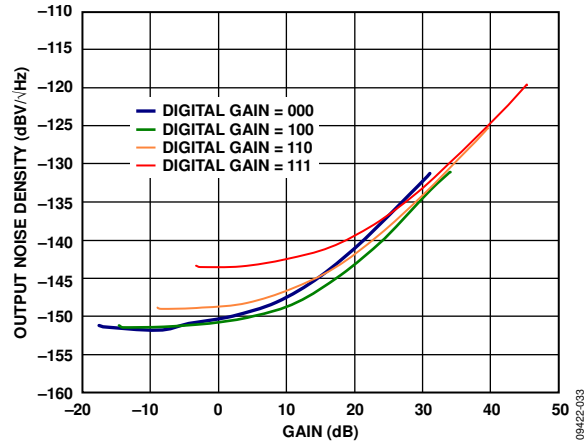

Figure 32. Output Noise Density vs. Analog Gain over Digital Gain (Bandwidth Setting = 31 MHz, Measured at 1/2 Bandwidth)

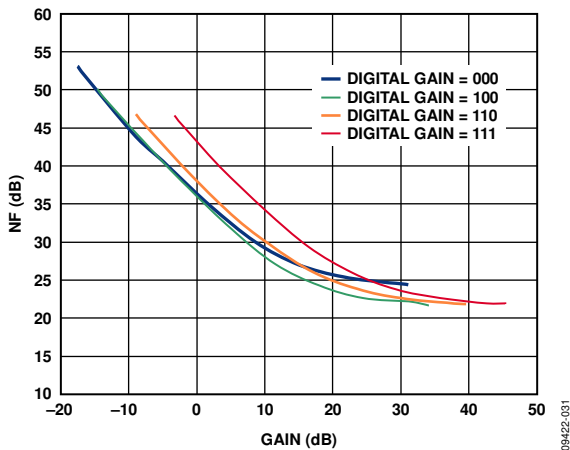

Figure 30. Noise Figure vs. Analog Gain over Digital Gain (Bandwidth Setting = 31 MHz, Noise Figure at 1/2 Bandwidth)

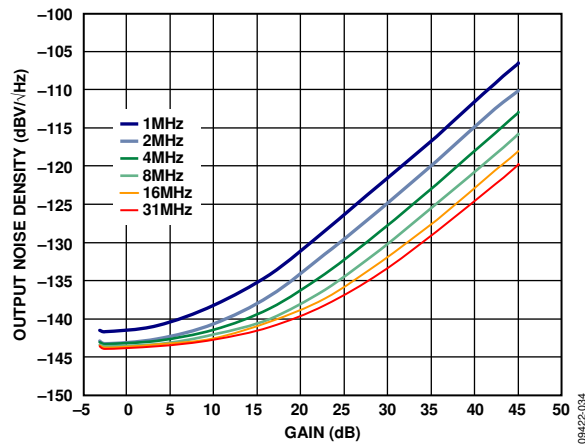

Figure 33. Output Noise Density vs. Gain over Bandwidth Setting (Digital Gain = 111, Measured at 1/2 Bandwidth)

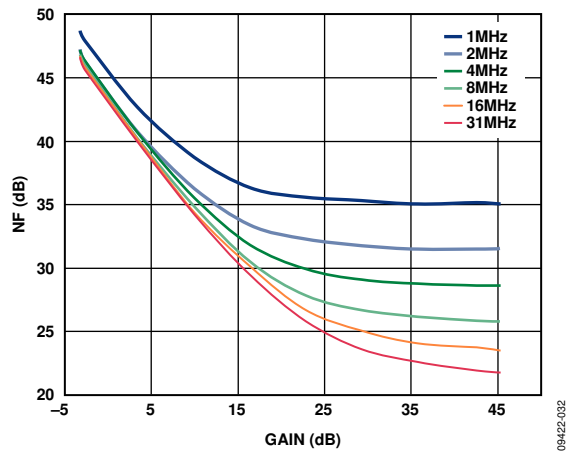

Figure 31. Noise Figure vs. Gain over Bandwidth Setting (Digital Gain = 111, Noise Figure at 1/2 Bandwidth)

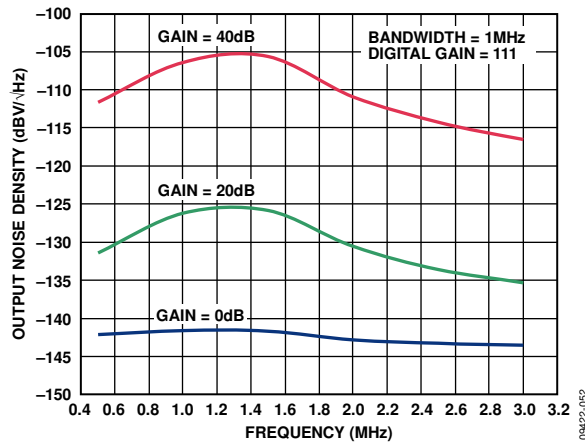

Figure 34. Output Noise Density vs. Frequency (Bandwidth Setting = 1 MHz, Digital Gain = 111)

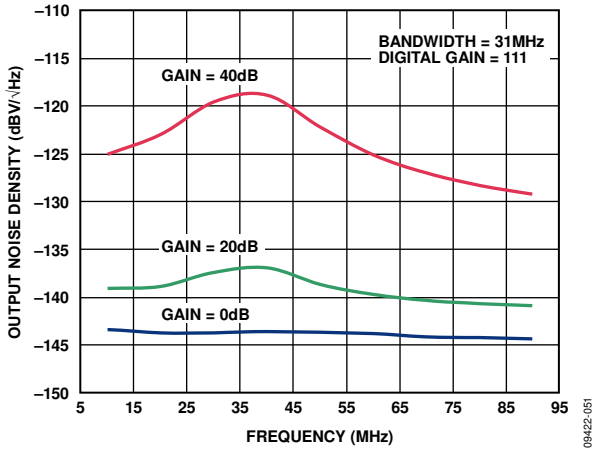

Figure 35. Output Noise Density vs. Frequency (Bandwidth Setting = 31 MHz, Digital Gain = 111)

09422-051

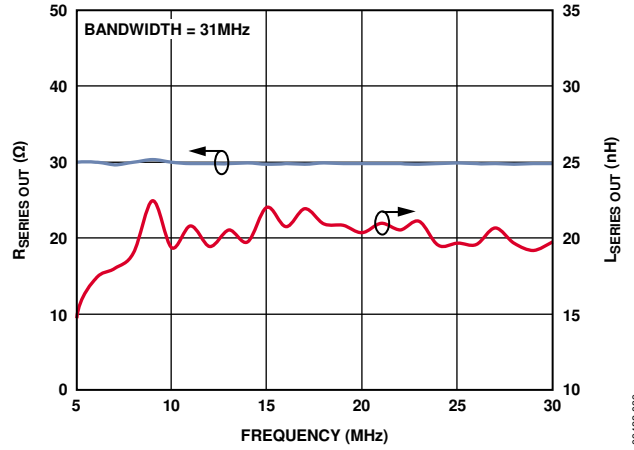

Figure 38. Output Impedance vs. Frequency (Bandwidth Setting = 31 MHz)

09422-039

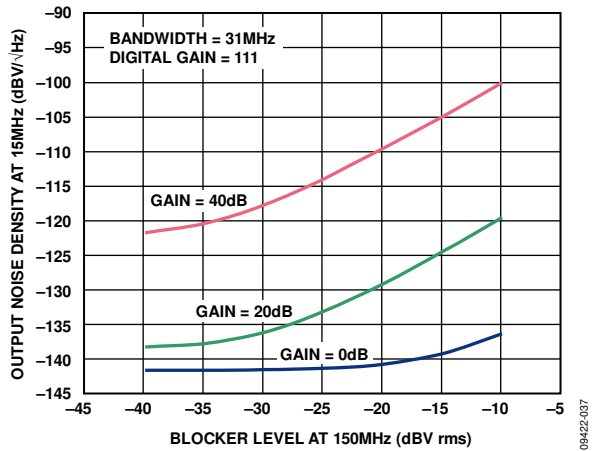

Figure 36. Output Noise Density vs. Input CW Blocker Level (Bandwidth Setting = 31 MHz, Blocker at 150 MHz)

09422-037

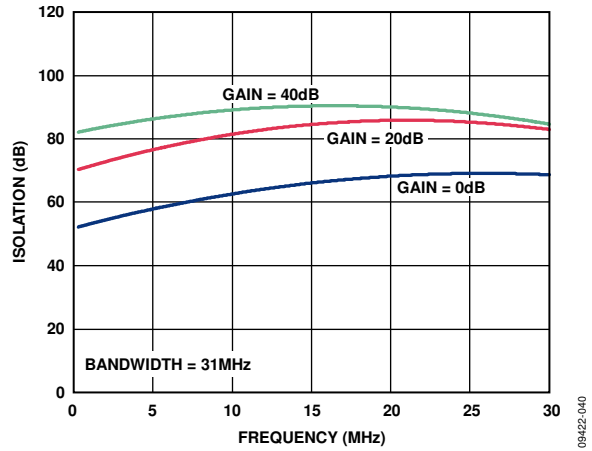

Figure 39. Channel Isolation, Output to Output, vs. Frequency (Bandwidth Setting = 31 MHz)

09422-040

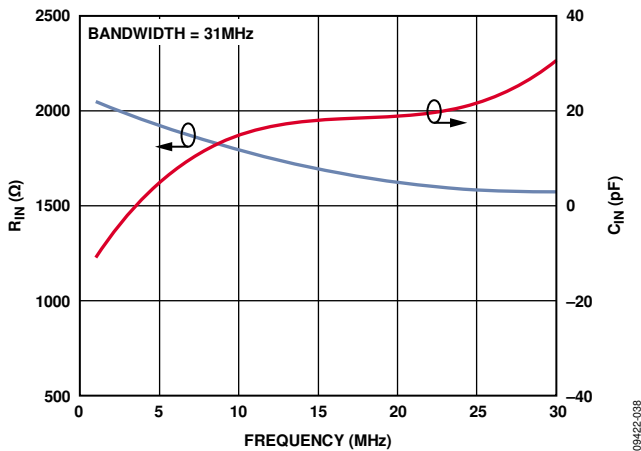

Figure 37. Input Impedance vs. Frequency (Bandwidth Setting = 31 MHz)

09422-038

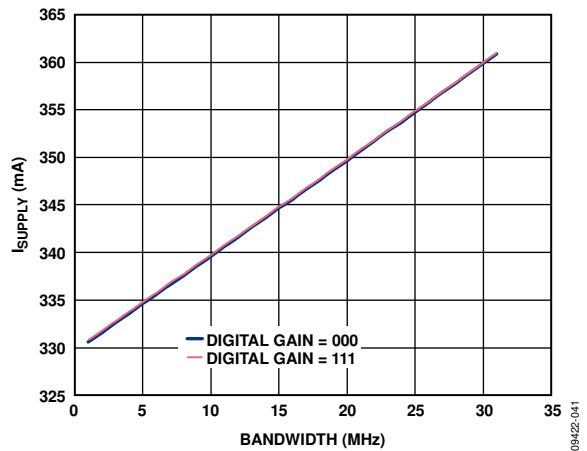

Figure 40. Current Consumption at Minimum and Maximum Digital Gain vs. Bandwidth (Bandwidth Setting = 31 MHz, Gain = 30 dB)

09422-041

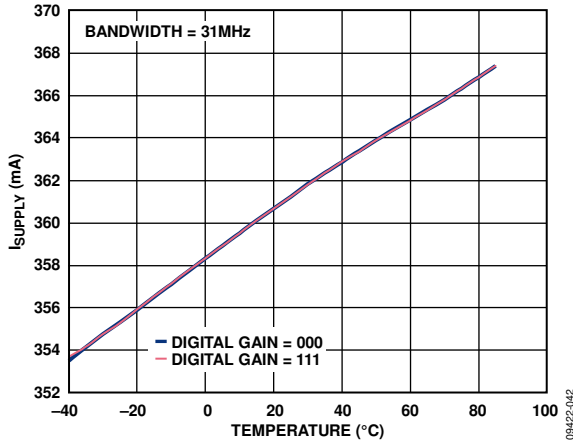

Figure 41. Current Consumption at Minimum and Maximum Digital Gain vs. Temperature (Bandwidth Setting = 31 MHz, Gain = 30 dB)

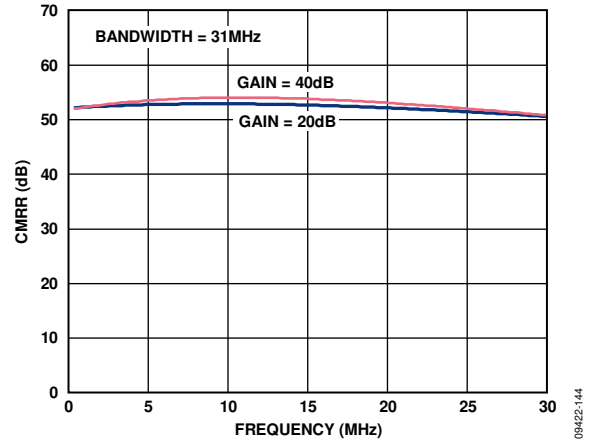

Figure 43. Common-Mode Rejection Ratio (CMRR) vs. Frequency (Bandwidth Setting = 31 MHz)

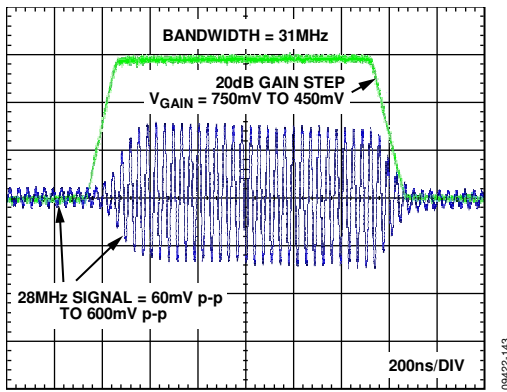

Figure 42. Gain Step Response

REGISTER MAP AND CODES

The filter frequency, preamplifier gain, postamplifier gain, and VGA maximum gain can be programmed using the SPI interface. Table 4 provides the bit map for the internal 8-bit register of the ADRF6516. The preamplifier, postamplifier, and VGA maximum gain code bits (Bits[B3:B1]) are referred to elsewhere in this data sheet as Digital Gain Code 000 through Digital Gain Code 111.

Table 4. Register Map

MSB							LSB
B8	B7	B6	B5	B4	B3	B2	B1
Filter frequency code					Preamplifier gain code	Postamplifier gain code	VGA max gain code
See Table 5					0 = 3 dB 1 = 6 dB	0 = 6 dB 1 = 12 dB	0 = 22 dB 1 = 28 dB

Table 5. Frequency Code vs. Corner Frequency Lookup Table

5-Bit Binary Frequency Code ¹	Corner Frequency (MHz)	5-Bit Binary Frequency Code ¹	Corner Frequency (MHz)
00000	No signal	10000	16
00001	1	10001	17
00010	2	10010	18
00011	3	10011	19
00100	4	10100	20
00101	5	10101	21
00110	6	10110	22
00111	7	10111	23
01000	8	11000	24
01001	9	11001	25
01010	10	11010	26
01011	11	11011	27
01100	12	11100	28
01101	13	11101	29
01110	14	11110	30
01111	15	11111	31

¹ MSB first.

THEORY OF OPERATION

The ADRF6516 consists of a matched pair of buffered, programmable filters followed by a cascade of two variable gain amplifiers and output ADC drivers. The block diagram of a single channel is shown in Figure 44.

The programmability of the bandwidth and of the pre- and post-filtering gain through the SPI interface offers great flexibility when coping with signals of varying levels in the presence of noise and large, undesired signals nearby. The entire differential signal chain is dc-coupled with flexible interfaces at the input and output. The bandwidth and gain setting controls for the two channels are shared, ensuring close matching of their magnitude and phase responses. The ADRF6516 can be fully disabled through the ENBL pin.

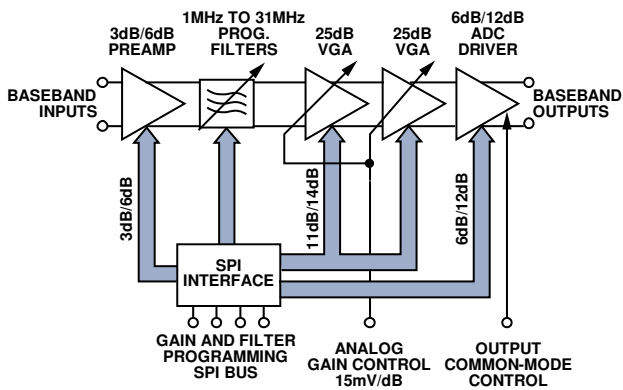

Figure 44. Signal Path Block Diagram for a Single Channel of the ADRF6516

Filtering and amplification are fundamental operations in any signal processing system. Filtering is necessary to select the intended signal while rejecting out-of-band noise and interferers. Amplification increases the level of the desired signal to overcome noise added by the system. When used together, filtering and amplification can extract a low level signal of interest in the presence of noise and out-of-band interferers. Such analog signal processing alleviates the requirements on the analog, mixed signal, and digital components that follow.

INPUT BUFFERS

The input buffers provide a convenient interface to the sensitive filter sections that follow. They set a differential input impedance of 1600 Ω and float to a common-mode voltage near VPS/2. The inputs can be dc-coupled or ac-coupled. If using direct dc coupling, the common-mode voltage presented to the inputs must be approximately VPS/2 to maximize the input swing capacity.

For a 3.3 V supply, the common-mode voltage can range from 1.1 V to 1.8 V while maintaining a >65 dBc HD3 for a 400 mV p-p input signal. The VICM pin provides the optimal midsupply common-mode voltage and can be used as a reference for the driving circuit. The VICM voltage is not buffered and must be sensed at a high impedance point to prevent it from being loaded down.

The input buffers in both channels can be configured simultaneously for a gain of 3 dB or 6 dB through the SPI (see the Register Map and Codes section). When configured for a 3 dB gain, the buffers support a 400 mV p-p differential input level with ~70 dBc harmonic distortion. For a 6 dB gain setting, the buffers support 280 mV p-p inputs.

PROGRAMMABLE FILTERS

The integrated programmable filter is the key signal processing function in the ADRF6516. The filters follow a six-pole Butterworth prototype response that provides a compromise between band rejection, ripple, and group delay. The 0.5 dB bandwidth is programmed from 1 MHz to 31 MHz in 1 MHz steps via the serial programming interface (SPI), as described in the Programming the Filters and Gains section.

The filters are designed so that the Butterworth prototype filter shape and group delay responses vs. frequency are retained for any bandwidth setting. Figure 45 and Figure 46 illustrate the ideal six-pole Butterworth magnitude and group delay responses, respectively. The group delay, τ_g , is defined as

$$\tau_g = -\partial\phi/\partial\omega$$

where:

ϕ is the phase in radians.

$\omega = 2\pi f$ (the frequency in radians/sec).

Note that for a frequency scaled filter prototype, the absolute magnitude of the group delay scales inversely with the bandwidth; however, the shape is retained. For example, the peak group delay for a 28 MHz bandwidth setting is 14× less than for a 2 MHz setting (see Figure 46).

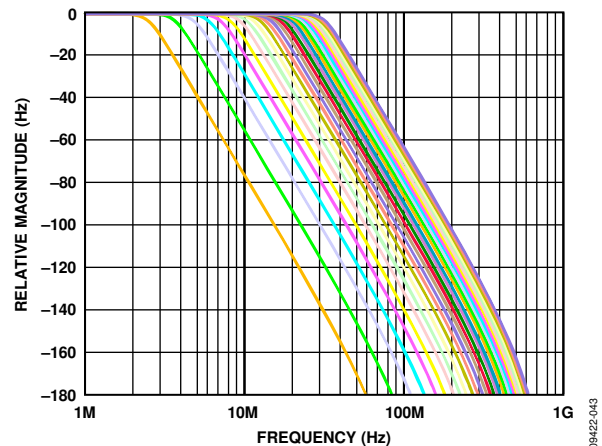

Figure 45. Sixth-Order Butterworth Magnitude Response for 0.5 dB Bandwidths Programmed from 2 MHz to 29 MHz in 1 MHz Steps

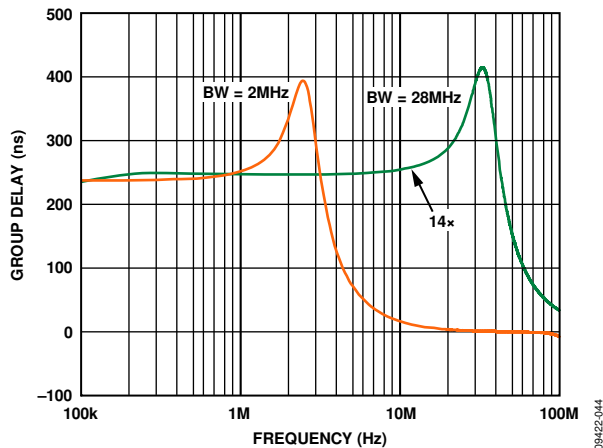

Figure 46. Sixth-Order Butterworth Group Delay Response for 0.5 dB Bandwidths Programmed to 2 MHz and 28 MHz

The corner frequency of the filters is defined by RC products, which can vary by $\pm 30\%$ in a typical process. Therefore, all the parts are factory calibrated for corner frequency, resulting in a residual $\pm 15\%$ corner frequency variation over the -40°C to $+85^{\circ}\text{C}$ temperature range. Although absolute accuracy requires calibration, the matching of RC products between the pair of channels is better than 1% by observing careful design and layout practices. Calibration and excellent matching ensure that the magnitude and group delay responses of both channels track together, a critical requirement for digital IQ-based communication systems.

VARIABLE GAIN AMPLIFIERS (VGAs)

The cascaded VGAs are based on the Analog Devices, Inc., patented X-AMP[®] architecture, consisting of tapped 25 dB attenuators followed by programmable gain amplifiers. The X-AMP architecture generates a continuous linear-in-dB monotonic gain response with low ripple. The analog gains of both cascaded VGA sections are controlled through the high impedance GAIN pin with an accurate slope of 15 mV/dB.

The gain response shown in Figure 47 shows the GAIN pin voltage range and the absence of gain foldback at high V_{GAIN} . By changing the gains of both VGAs simultaneously, a more gradual variation in noise and distortion is achieved. The fixed gain following each of the variable gain sections can also be programmed to two different values to maximize dynamic range.

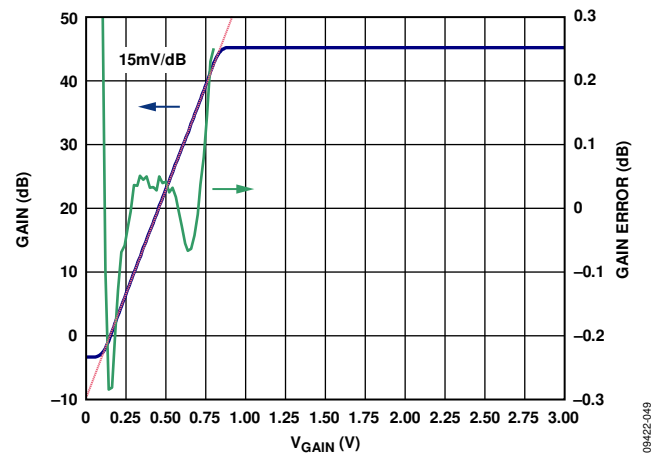

Figure 47. Linear-in-dB Gain Control Response of the X-AMP VGA Cascade Showing Consistent Slope and Low Error

OUTPUT BUFFERS/ADC DRIVERS

The low impedance ($30\ \Omega$) output buffers of the [ADRF6516](#) are designed to drive either ADC inputs or subsequent amplifier stages. They are capable of delivering up to 1.5 V p-p composite two-tone signals into $1\ \text{k}\Omega$ differential loads with $>65\ \text{dBc}$ IMD3. The output common-mode voltage defaults to $V_{\text{PS}}/2$, but it can be adjusted from 700 mV to 2.8 V without loss of drive capability by presenting the VO_{CM} pin with the desired common-mode voltage. The high input impedance of VO_{CM} allows the ADC reference output to be connected directly. Even though the output common-mode voltage is adjustable and the offset compensation loop can null the accumulated dc offsets (see the DC Offset Compensation Loop section), it may still be desirable to ac couple the outputs by selecting the coupling capacitors according to the load impedance and desired bandwidth.

DC OFFSET COMPENSATION LOOP

In many signal processing applications, no information is carried in the dc level. In fact, dc voltages and other low frequency disturbances can often dominate the intended signal and consume precious dynamic range in the analog path and bits in the data converters. These dc voltages can be present with the desired input signal or can be generated inside the signal path by inherent dc offsets or other unintended signal-dependent processes such as self-mixing or rectification.

Because the [ADRF6516](#) is fully dc-coupled, it may be necessary to remove these offsets to realize the maximum signal-to-noise ratio (SNR). This can be achieved with ac coupling capacitors at the input and output pins; however, large value capacitors with low impedance values are required because the high-pass corners must be $<10\ \text{Hz}$. To address the issue of dc offsets, the [ADRF6516](#) provides an offset compensation loop that nulls the output differential dc level, as shown in Figure 48. If the compensation loop is not required, it can be disabled by pulling the OFDS pin high.

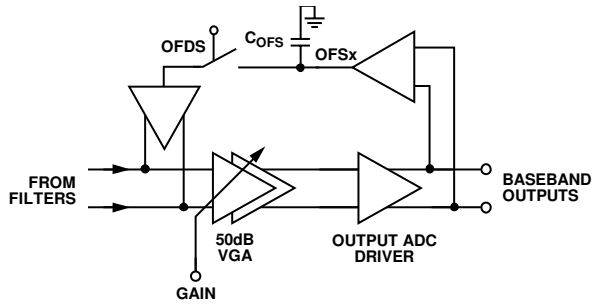

Figure 48. Offset Compensation Loop Operates Around the VGA and Output Buffer

The offset compensation loop creates a high-pass corner, f_{HP} , that is superimposed on the normal Butterworth filter response. Typically, f_{HP} is many orders of magnitude lower than the lowest programmed filter bandwidth so that there is no interaction between them. Setting f_{HP} is accomplished with capacitors, C_{OFS} , from the OFS1 and OFS2 pins to ground. Because the compensation loop works around the VGA sections, f_{HP} is also dependent on the total gain of the cascaded VGAs. In general, the expression for f_{HP} is given by

$$f_{HP} \text{ (Hz)} = 6.7 \times (\text{Post Filter Linear Gain} / C_{OFS} \text{ (}\mu\text{F)})$$

where *Post Filter Linear Gain* is expressed in linear terms, not in decibels (dB), and is the gain following the filters, which excludes the preamplifier gain of 1.4 (3 dB) or 2 (6 dB).

Note that f_{HP} increases in proportion to the gain. For this reason, C_{OFS} must be chosen at the highest operating gain to guarantee that f_{HP} is always below the maximum limit required by the system.

PROGRAMMING THE FILTERS AND GAINS

The 0.5 dB corner frequencies for both filters and the gains of the preamplifiers and postamplifiers are programmed simultaneously through the SPI port. An 8-bit register stores the 5-bit code for corner frequencies of 1 MHz through 31 MHz, as well as the 1-bit codes for the preamplifier gain, the VGA maximum gain, and the postamplifier gain (see Table 4). The SPI protocol not only allows frequency and gain codes to be written to the DATA pin, but it also allows the stored code to be read back via the SDO pin.

The latch enable (LE) pin must first go to a Logic 0 for a read or write cycle to begin. On the next rising edge of the clock (CLK), a Logic 1 on the DATA pin initiates a write cycle, whereas a Logic 0 on the DATA pin initiates a read cycle. In a write cycle, the next eight CLK rising edges latch the desired 8-bit code, LSB first. When LE goes high, the write cycle is completed and the frequency and gain codes are presented to the filter and amplifiers. In a read cycle, the next eight CLK falling edges present the stored 8-bit code, LSB first. When LE goes high, the read cycle is completed. Detailed timing diagrams are shown in Figure 2 and Figure 3.

NOISE CHARACTERISTICS

The output noise behavior of the ADRF6516 depends on the gain and bandwidth settings. Figure 49 and Figure 50 show the total output noise spectral density vs. frequency for different bandwidth settings and VGA gains.

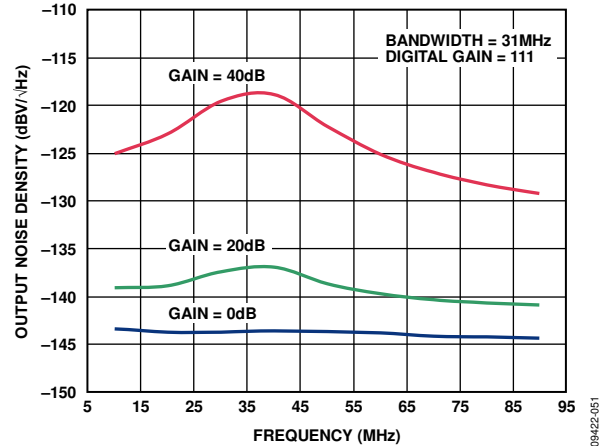

Figure 49. Total Output Noise Density with a 31 MHz Corner Frequency for Three Different Gain Settings

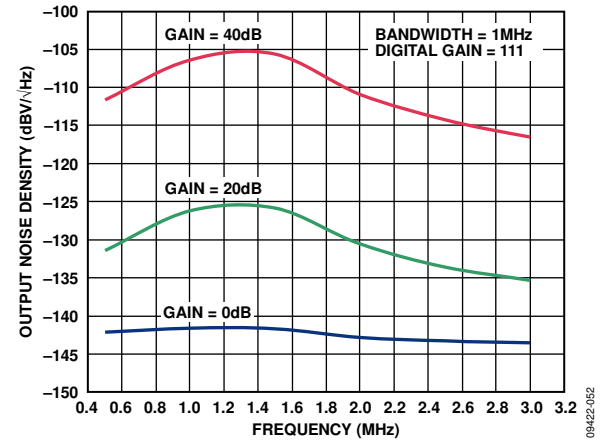

Figure 50. Total Output Noise Density with a 1 MHz Corner Frequency for Three Different Gain Settings

Both the filter sections and the VGAs contribute to the total noise at the output. The filter contributes a noise spectral density profile that is flat at low frequencies, peaks near the corner frequency, and then rolls off as the filter poles roll off the gain and noise. The magnitude of the noise spectral density contributed by the filter, expressed in $nV/\sqrt{\text{Hz}}$, varies inversely with the square root of the bandwidth setting, resulting in a total integrated noise in nV that is nearly constant with bandwidth setting. At higher frequencies, after the filter noise rolls off, the noise floor is set by the VGAs.

Each of the X-AMP VGA sections used in the ADRF6516 contributes a fixed and flat noise spectral density to its respective output, independent of the gain setting. Because the VGAs are cascaded in the ADRF6516, the total noise contributed by the VGAs at the output increases gradually with higher gain. This is apparent in the noise floor variation at high frequencies at different VGA gain settings.

The exact relationship depends on the programmed fixed gain of the amplifiers. At minimum gain, only the last VGA contributes to the $-144 \text{ dBV}/\sqrt{\text{Hz}}$ minimum noise floor, which is equivalent to $63 \text{ nV}/\sqrt{\text{Hz}}$. At lower frequencies within the filter bandwidth setting, the VGAs translate the filter noise directly to the output by a factor equal to the gain following the filter.

At low values of VGA gain, the noise at the output is the flat spectral density contributed by the last VGA. As the gain increases, more noise from the filter and first VGA appears at the output. Because the intrinsic filter noise density increases at lower bandwidth settings, it is more pronounced than it is at higher bandwidth settings. In either case, the noise density asymptotically approaches the limit set by the VGAs at the highest frequencies. For other values of VGA gain and bandwidth setting, the detailed shape of the noise spectral density changes according to the relative contributions of the filters and VGAs.

Because the noise spectral density outside the filter bandwidth is limited by the VGA output noise, it may be necessary to use an external, fixed-frequency, passive filter prior to analog-to-digital conversion to prevent noise aliasing from degrading the signal-to-noise ratio. A higher sampling rate relative to the maximum required [ADRF6516](#) corner frequency setting reduces the order and complexity of this external filter.

DISTORTION CHARACTERISTICS

The distortion performance of the [ADRF6516](#) is similar to its noise performance. The filters and the VGAs contribute to the overall distortion and signal handling capabilities. Furthermore, the front end must also cope with out-of-band signals that can be larger than the in-band signals. These out-of-band signals are filtered before reaching the VGA. It is important to understand the signals presented to the [ADRF6516](#) and to match these signals with the input and output characteristics of the part.

When the gain is low, the distortion is typically limited by the input section because the output is not driven to its maximum capacity. When the gain is high, the distortion is likely limited by the output section because the input is not driven to its maximum capacity. An exception to this is when the input is driven with a small desired signal in combination with a large out-of-band signal. In this case, the out-of-band signal may drive the input to distort. As long as the input is not overdriven, the out-of-band signal is removed by the filter. A high VGA gain is still needed to raise the small desired signal to a higher level at the output. The overall distortion introduced by the part depends on the input drive level, including the out-of-band signals, and the desired output signal level.

As noted in the Input Buffers section, the input section can handle a total signal level of 400 mV p-p for a 3 dB preamplifier gain and 280 mV p-p for a 6 dB preamplifier gain with $>70 \text{ dBc}$ harmonic distortion. This includes both in-band and out-of-band signals.

To distinguish and quantify the distortion performance of the input section, two different IP3 specifications are presented. The first is called in-band IP3 and refers to a two-tone test where the signals are inside the filter bandwidth. This is exactly the same figure of merit familiar to communications engineers in which the third-order intermodulation level, IMD3, is measured.

To quantify the effect of out-of-band signals, a new out-of-band (OOB) IIP3 figure of merit is introduced. This test also involves a two-tone stimulus; however, the two tones are placed out-of-band so that the lower IMD3 product lands in the middle of the filter pass band. At the output, only the IMD3 product is visible because the original two tones are filtered out. To calculate the OOB IIP3 at the input, the IMD3 level is referred to the input by the overall gain. The OOB IIP3 allows the user to predict the impact of out-of-band blockers or interferers at an arbitrary signal level on the in-band performance. The ratio of the desired input signal level to the input-referred IMD3 at a given blocker level represents a signal-to-distortion limit imposed by the out-of-band signals.

MAXIMIZING THE DYNAMIC RANGE

The role of the [ADRF6516](#) is to increase the level of a variable in-band signal while minimizing out-of-band signals. Ideally, this is achieved without degrading the SNR of the incoming signal or introducing distortion to the incoming signal.

The first goal is to maximize the output signal swing, which can be defined by the ADC input range or the input signal capacity of the next analog stage. For the complex waveforms often encountered in communication systems, the peak-to-average ratio, or crest factor, must be considered when selecting the peak-to-peak output. From the selected output signal and the maximum gain of the [ADRF6516](#), the minimum input level can be defined. Lower signal levels do not yield the maximum output and suffer a greater degradation in SNR.

As the input signal level increases, the VGA gain is reduced from its maximum gain point to maintain the desired fixed output level. The output noise, initially dominated by the filter, follows the gain reduction, yielding a progressively better SNR. At some point, the VGA gain drops sufficiently that the VGA noise becomes dominant, resulting in a slower reduction in SNR from that point. From the perspective of SNR alone, the maximum input level is reached when the VGA reaches its minimum gain.

Distortion must also be considered when maximizing the dynamic range. At low and moderate signal levels, the output distortion is constant and assumed to be adequate for the selected output level. At some point, the input signal becomes large enough that distortion at the input limits the system. The maximum tolerable input signal depends on whether the input distortion becomes unacceptably large or the minimum gain is reached.

The most challenging scenario in terms of dynamic range is the presence of a large out-of-band blocker accompanying a weaker in-band desired signal. In this case, the maximum input level is dictated by the blocker and its inclination to cause distortion. After filtering, the weak desired signal must be amplified to the desired output level, possibly requiring maximum gain. Both the distortion limits associated with the blocker at the input and the SNR limits created by the weaker signal and higher gains are present simultaneously. Furthermore, not only does the blocker scenario degrade the dynamic range, it also reduces the range of input signals that can be handled because a larger part of the gain range is used to simply extract the weak desired signal from the stronger blocker.

KEY PARAMETERS FOR QUADRATURE-BASED RECEIVERS

The majority of digital communication receivers makes use of quadrature signaling, in which bits of information are encoded onto pairs of baseband signals that then modulate in-phase (I) and quadrature (Q) sinusoidal carriers. Both the baseband and modulated signals appear quite complex in the time domain with dramatic peaks and valleys. In a typical receiver, the goal is to recover the pair of quadrature baseband signals in the presence of noise and interfering signals after quadrature demodulation. In the process of filtering out-of-band noise and undesired interferers and restoring the levels of the desired I and Q baseband signals, it is critical to retain their gain and phase integrity over the bandwidth.

The [ADRF6516](#) delivers flat in-band gain and group delay, consistent with a six-pole Butterworth prototype filter, as described in the Programmable Filters section. Furthermore, careful design ensures excellent matching of these parameters between the I and Q channels. Although absolute gain flatness and group delay can be corrected with digital equalization, mismatch introduces quadrature errors and intersymbol interference that degrade bit error rates in digital communication systems.

APPLICATIONS INFORMATION

BASIC CONNECTIONS

Figure 51 shows the basic connections for a typical ADRF6516 application.

SUPPLY DECOUPLING

A nominal supply voltage of 3.3 V must be applied to the supply pins. The supply voltage must not exceed 3.45 V or drop below 3.15 V. Each supply pin must be decoupled to ground with at least one low inductance, surface-mount ceramic capacitor of 0.1 μF placed as close as possible to the ADRF6516 device.

The ADRF6516 has two separate supplies: an analog supply and a digital supply. Take care to separate the analog and digital supplies with a large surface-mount inductor of 33 μH . Decouple each supply separately to its respective ground through a 10 μF capacitor.

INPUT SIGNAL PATH

Each signal path has input buffers, accessed through the INP1, INM1, INP2, and INM2 pins, that set a differential input impedance of 1600 Ω . These inputs sit at a nominal common-mode voltage around midsupply.

The inputs can be dc-coupled or ac-coupled. If using direct dc coupling, the common-mode voltage, V_{CM} , can range from 1.1 V to 1.8 V. The VICM pin can be used as a reference common-mode voltage for driving a high impedance sensing node of the preceding cascaded part (VICM has a 7 k Ω impedance).

For example, the high impedance VOCCM input pin of the ADRF6806 quadrature demodulator can be directly connected to the VICM pin of the ADRF6516. This gives the ADRF6806 the optimal common-mode voltage reference to drive the ADRF6516.

OUTPUT SIGNAL PATH

The low impedance (30 Ω) output buffers are designed to drive a high impedance load, such as an ADC input or another amplifier stage. The output pins—OPP1, OPM1, OPP2, and OPM2—sit at a nominal output common-mode voltage of $V_{\text{PS}}/2$, but can be driven to a voltage of 0.7 V to 2.8 V by applying the desired common-mode voltage to the high impedance VOCCM pin.

DC OFFSET COMPENSATION LOOP ENABLED

When the dc offset compensation loop is enabled via the OFDS pin, the ADRF6516 can null the output differential dc level. The loop is enabled by pulling the OFDS pin low to ground. The offset compensation loop creates a high-pass corner frequency, which is proportional to the value of the capacitors that are connected from the OFS1 and OFS2 pins to ground. For more information about setting the high-pass corner frequency, see the DC Offset Compensation Loop section.

COMMON-MODE BYPASSING

The ADRF6516 common-mode pins, VICM and VOCCM, must be decoupled to ground. Use at least one low inductance, surface-mount ceramic capacitor with a value of 0.1 μF to decouple the common-mode pins.

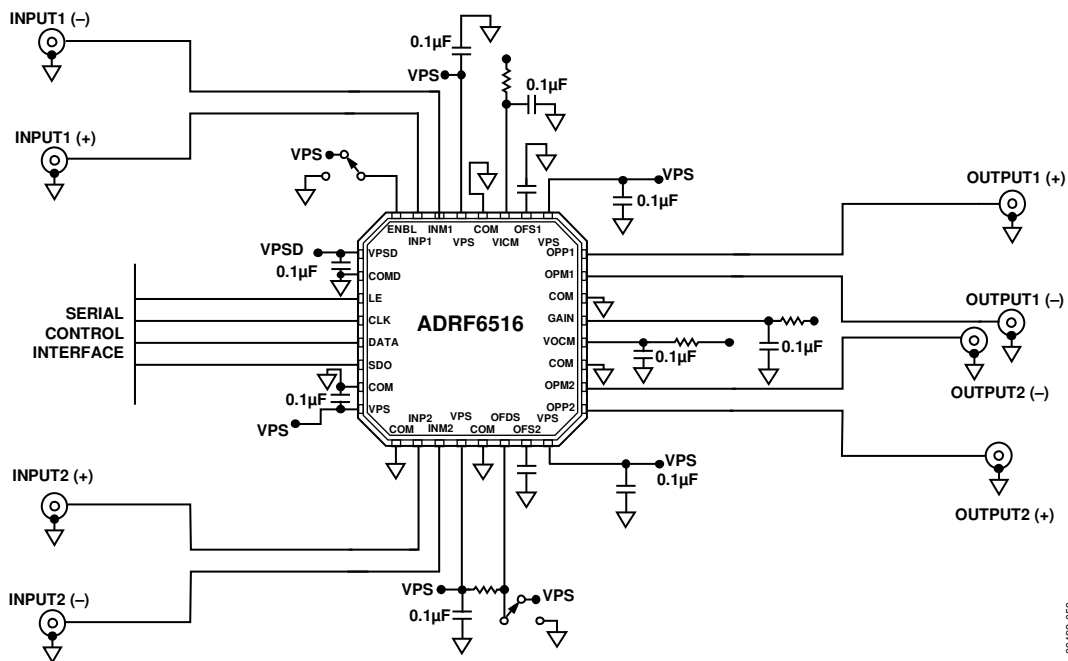

Figure 51. Basic Connections

09422-053

SERIAL PORT CONNECTIONS

The ADRF6516 has a SPI port to control the gain and filter bandwidth settings. Data can be written to the internal 8-bit register and read from the register. It is recommended that low-pass RC filtering be placed on the SPI lines to filter out any high frequency glitches. See Figure 58, the evaluation board schematic, for an example of a low-pass RC filter.

ENABLE/DISABLE FUNCTION

To enable the ADRF6516, the ENBL pin must be pulled high. Driving the ENBL pin low disables the device, reducing current consumption to approximately 9 mA at room temperature.

ERROR VECTOR MAGNITUDE (EVM) PERFORMANCE

Error vector magnitude (EVM) is a measure used to quantify the performance of a digital radio transmitter or receiver by measuring the fidelity of the digital signal transmitted or received. Various imperfections in the link, such as magnitude and phase imbalance, noise, and distortion, cause the constellation points to deviate from their ideal locations.

In general, a receiver exhibits three distinct EVM limitations vs. received input signal power. As signal power increases, the distortion components increase.

- At large enough signal levels, where the distortion components due to the harmonic nonlinearities in the device are falling in-band, EVM degrades as signal levels increase.
- At medium signal levels, where the signal chain behaves in a linear manner and the signal is well above any notable noise contributions, EVM has a tendency to reach an optimal level determined dominantly by either the quadrature accuracy and IQ gain match of the signal chain or the precision of the test equipment.
- As signal levels decrease, such that noise is a major contributor, EVM performance vs. the signal level exhibits a decibel-for-decibel degradation with decreasing signal level. At these lower signal levels, where noise is the dominant limitation, decibel EVM is directly proportional to the SNR.

EVM TEST SETUP

The basic setup to test EVM for the ADRF6516 consisted of an Agilent E4438C used as a signal source and a Hewlett-Packard 89410A vector signal analyzer (VSA) used to sample and calculate the EVM of the signal. The E4438C IQ baseband differential outputs drove the ADRF6516 inputs. The I and Q outputs of the ADRF6516 were loaded with 1 kΩ differential impedances and connected differentially to two AD8130 differential amplifiers to convert the signals into single-ended signals. The single-ended signals were connected to the input channels of the VSA.

EFFECT OF FILTER BANDWIDTH ON EVM

Take care when selecting the filter bandwidth. In a digital transceiver, the modulated signal is filtered by a pulse shaping filter (such as a root-raised cosine filter) at both the transmit and receive ends to guard against intersymbol interference (ISI). If additional filtering of the modulated signal is done, the signal must be within the pass band of the filter. When the corner frequency of the ADRF6516 filter begins to encroach on the modulated signal, ISI is introduced and degrades EVM, which can lead to loss of signal lock.

Figure 52 shows that a digitally modulated QAM baseband signal with a bandwidth at 9.45 MHz has excellent EVM even at a filter corner frequency of 8 MHz. Further reduction in the corner frequency leads to complete loss of lock. As RF input power was swept, the ADRF6516 attained an EVM of less than -45 dB over an input power range of approximately 20 dB.

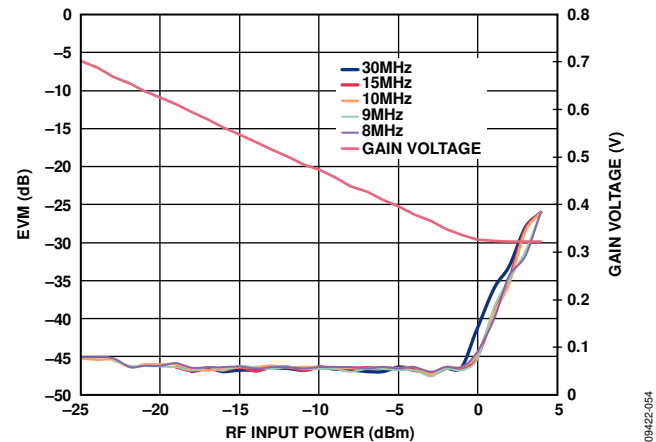

Figure 52. EVM vs. RF Input Power at Several Filter Corner Settings (256-QAM, 14 MSPS Signal with $\alpha = 0.35$; Output Differential Signal Level Held to 700 mV p-p; OFDS Pulled High)

Figure 53 shows the degradation that a fixed filter corner has on EVM as the signal bandwidth corner is increased in fine increments until loss of signal lock occurs.

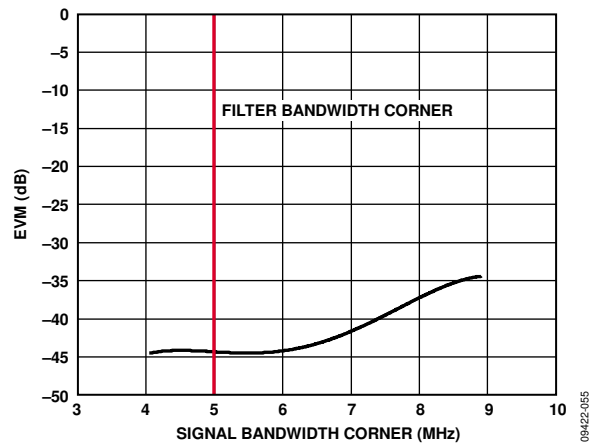

Figure 53. EVM vs. Signal Bandwidth Corner at a Filter Corner of 5 MHz and a 16-QAM Signal with $\alpha = 0.35$

EFFECT OF OUTPUT VOLTAGE LEVELS ON EVM

Output voltage level can affect EVM greatly when the signal is compressed. When changing the output voltage levels of the ADRF6516, take care that the output signal is not in compression, which causes EVM degradation.

Figure 54 show EVM performance vs. RF input power for several maximum differential I and Q output voltage levels of 350 mV p-p up to 2.4 V p-p. For the lower maximum differential output voltage levels, the EVM is less than -45 dB over approximately 20 dB of input power range.

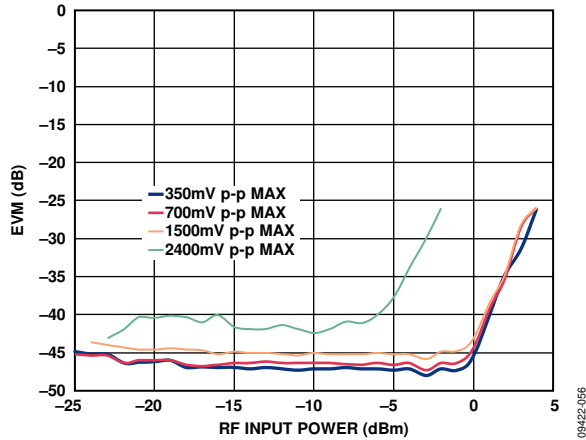

Figure 54. EVM vs. RF Input Power at Several Output Maximum Differential Voltage Levels (Filter Corner = 10 MHz, OFDS Pulled High)

For the largest tested maximum differential output voltage level of 2.4 V p-p, the ADRF6516 begins to compress the signal. This compression causes EVM to degrade, but it still remains below -40 dB, albeit over a truncated input power range. At the high end of the input power range, the signal is in full compression and EVM is large. Given that the gain is near its minimum, the input signal level must be lowered to bring the output signal out of full compression and into the proper linear operating region.

EFFECT OF C_{OFS} VALUE ON EVM

When enabled, the dc offset compensation loop effectively nulls any information below the high-pass corner set by the C_{OFS} capacitor. However, loss of the low frequency information of the modulated signal can degrade the EVM in some cases.

As the signal bandwidth becomes larger, the percentage of information that is corrupted by the high-pass corner becomes smaller. In such cases, it is important to select a C_{OFS} capacitor that is large enough to minimize the high-pass corner frequency, which prevents loss of information and degraded EVM.

Figure 55 shows degradation of the EVM vs. RF input power as the C_{OFS} capacitor value becomes smaller, which increases the high-pass corner for the dc offset compensation loop.

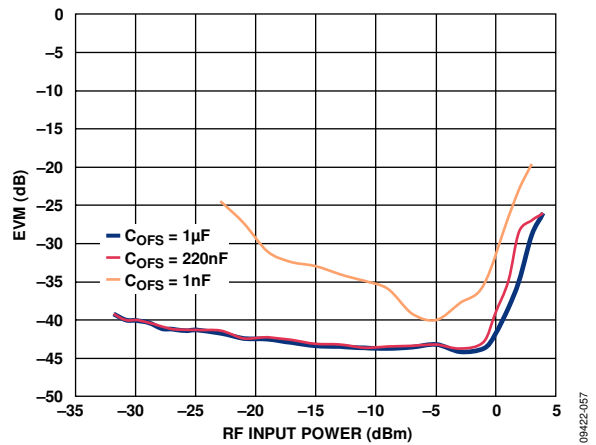

Figure 55. EVM vs. RF Input Power at Several C_{OFS} Values (Filter Corner = 10 MHz, 256-QAM, 14 MSPS Signal with $\alpha = 0.35$; Output Differential Signal Level Held to 700 mV p-p; OFDS Pulled Low)

Figure 56 shows the effect that C_{OFS} has on several modulated signal bandwidths. The modulated bandwidth was swept while using 1000 pF and 1 µF values for C_{OFS}. Total gain was set to 15 dB, so the high-pass filter corner of the 1000 pF capacitor is 26.67 kHz, and the high-pass filter corner of the 1 µF capacitor is 26.67 Hz. It is recommended that at moderate signal bandwidths, a 1 µF capacitor for C_{OFS} be used to obtain the best EVM when using the dc offset compensation loop.

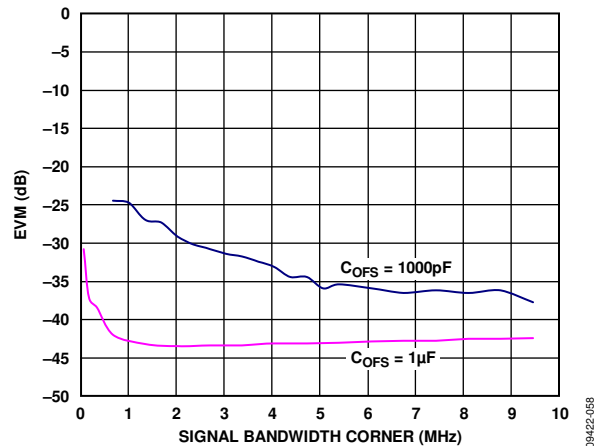

Figure 56. EVM vs. Signal Bandwidth Corner with C_{OFS} = 1 µF and C_{OFS} = 1000 pF (Filter Corner = 10 MHz)

EVALUATION BOARD

An evaluation board is available for testing the [ADRF6516](#). The evaluation board schematic is shown in Figure 58. Table 6 provides the component values and suggestions for modifying the component values for the various modes of operation.

EVALUATION BOARD CONTROL SOFTWARE

The [ADRF6516](#) evaluation board is controlled through the parallel port on a PC. The parallel port is programmed via the [ADRF6516](#) evaluation software. This software controls the filter corner frequency, as well as the minimum and maximum gains for each amplifier in the [ADRF6516](#). For information about the register map, see Table 4 and Table 5. For information about SPI port timing and control, see Figure 2 and Figure 3.

After the evaluation software is downloaded and installed, start the basic user interface to program the filter corner and gain values (see Figure 57).

To program the filter corner, do one of the following:

- Click the arrow in the **Frequency Select** section of the window, select the desired corner frequency from the menu, and click **Write Bits**.
- Click **Freq +1 MHz** or **Freq -1 MHz** to increment or decrement the corner frequency in 1 MHz steps from the current corner frequency.

To program the preamplifier gain, the VGA maximum gain, and the postamplifier gain, move the slider switch in the appropriate section of the window to the desired gain.

- The preamplifier gain can be set to 3 dB or 6 dB.
- The VGA maximum gain can be set to 22 dB or 28 dB.
- The postamplifier gain can be set to 6 dB or 12 dB.

When the user clicks the **Write Bits** button, a write operation is executed, immediately followed by a read operation. The updated information is displayed in the **Current Pre-Amp Gain**, **Current Frequency**, **Current VGA Max Gain**, and **Current Post-Amp Gain** fields.

When the parallel port is updated with a read/write operation, the current cumulative maximum gain of all the amplifiers is displayed in the **Maximum Gain** field. (The analog VGA gain is not included in this value.)

Because the speed of the parallel port varies from PC to PC, the **Clock Stretch** function can be used to change the effective frequency of the CLK line. The CLK line has a scalar range from 1 to 10; 10 is the fastest speed, and 1 is the slowest.

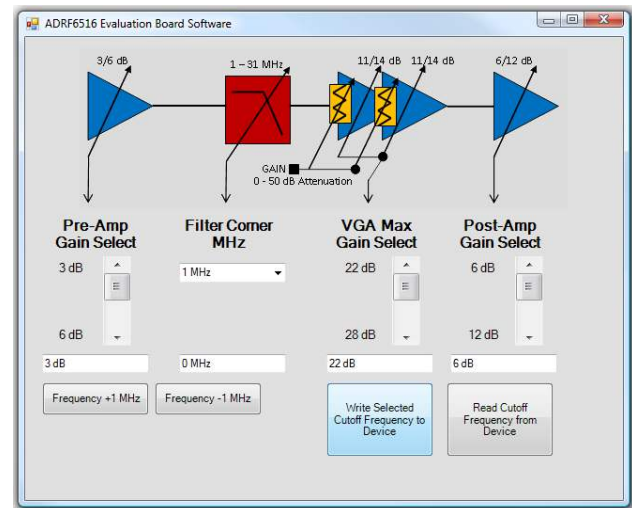

Figure 57. [ADRF6516](#) Evaluation Software

SCHEMATICS AND ARTWORK

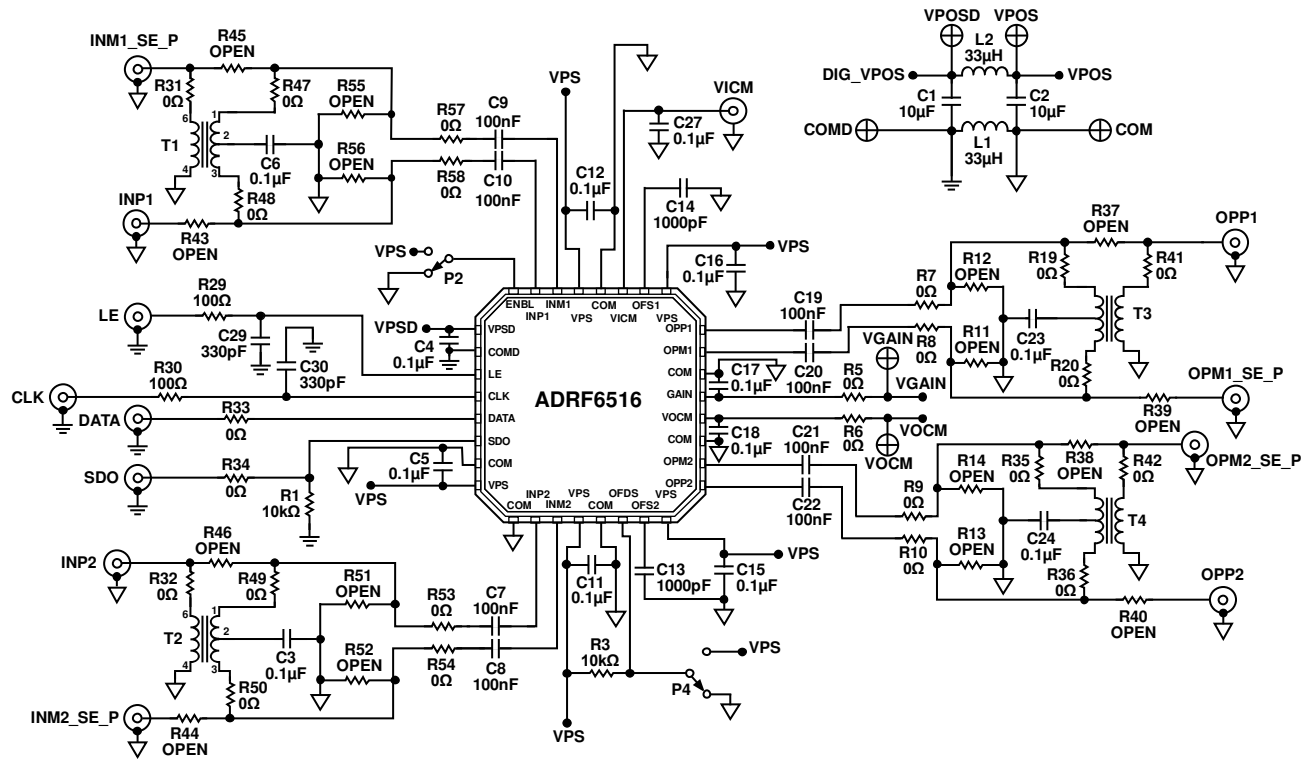

Figure 58. Evaluation Board Schematic

084422-061

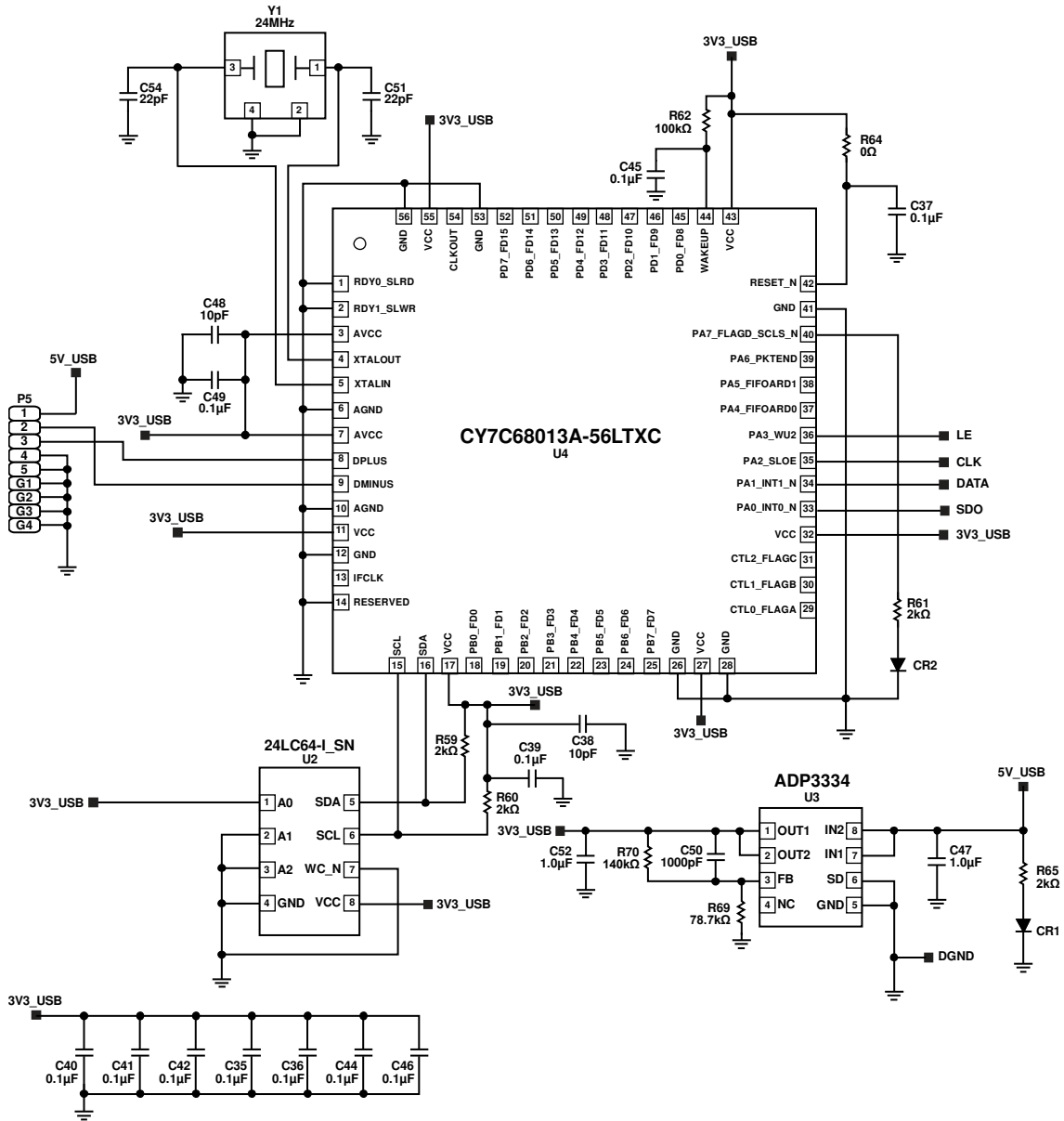

Figure 59. USB Evaluation Board Schematic

09422-159

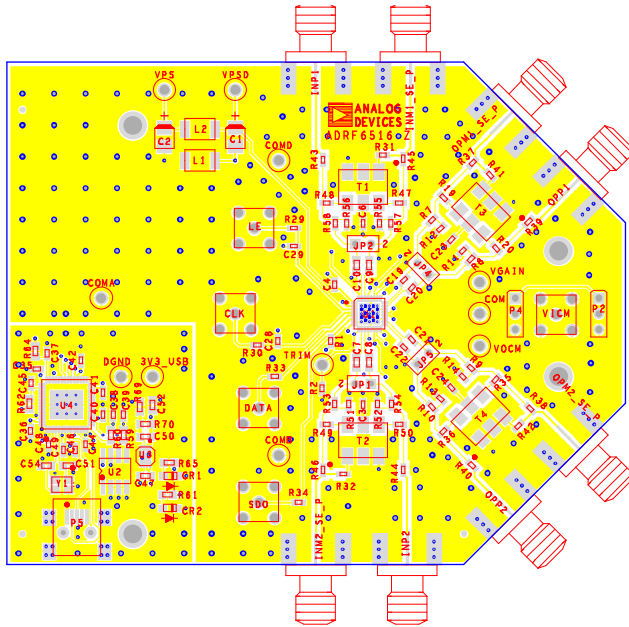

Figure 60. Top Layer Silkscreen

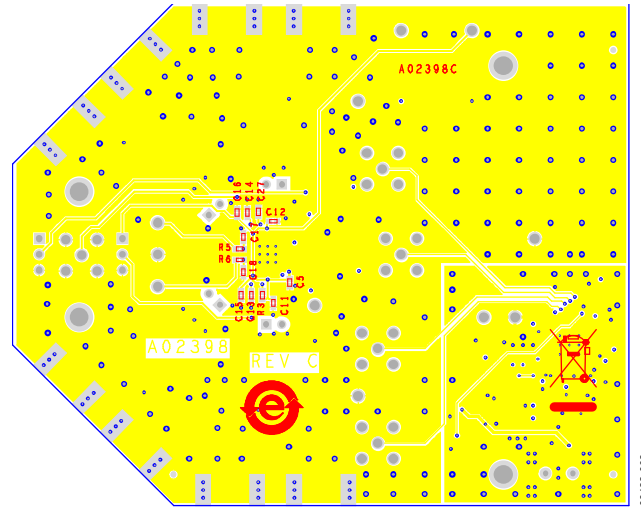

Figure 61. Component Side Layout

Table 6. Evaluation Board Configuration Options

Components	Function	Default Conditions
C1, C2, C4, C5, C11, C12, C15, C16, L1, L2, R2	Power supply and ground decoupling. Nominal supply decoupling consists of a 0.1 μF capacitor to ground.	C1, C2 = 10 μF (Size 1210) C4, C5, C11, C12, C15, C16 = 0.1 μF (Size 0402) L1, L2 = 33 μH (Size 1812) R2 = 1 k Ω (Size 0402)
T1, T2, C3, C6, C7 to C10, R31, R32, R43 to R58	Input interface. Input SMAs INP1, INM1_SE_P, INP2_SE_P, and INM2 are used to drive the part differentially by bypassing the baluns. Using only INM1_SE_P and INP2_SE_P in conjunction with the baluns enables single-ended operation. The default configuration of the evaluation board is for single-ended operation. T1 and T2 are 8:1 impedance ratio baluns that transform a single-ended signal in a 50 Ω system into a balanced differential signal in a 400 Ω system. R31, R32, R47, R48, R49, and R50 are populated for appropriate balun interface. R51 to R58 are provided for generic placement of matching components. To bypass the T1 and T2 baluns for differential interfacing, remove the balun interfacing resistors R31, R32, R47, R48, R49, and R50, and populate R43, R44, R45, and R46 with 0 Ω resistors.	T1, T2 = ADT8-1T+ (Mini-Circuits) C3, C6 = 0.1 μF (Size 0402) C7 to C10 = 100 nF (Size 0602) R31, R32, R47 to R50, R53, R54, R57, R58 = 0 Ω (Size 0402) R43 to R46, R51, R52, R55, R56 = open (Size 0402)
T3, T4, C19 to C24, R7 to R14, R19, R20, R35 to R42	Output interface. Output SMAs OPP1_SE_P, OPM1, OPP2, and OPM2_SE_P are used to obtain differential signals from the part when the output baluns are bypassed. Using OPP1_SE_P, OPM2_SE_P, and the baluns, the user can obtain single-ended output signals. The default configuration of the evaluation board is for single-ended operation. T3 and T4 are 8:1 impedance ratio baluns that transform a differential signal in a 400 Ω system into a single-ended signal in a 50 Ω system. R7, R8, R9, R10, R19, R20, R35, R36, R41, and R42 are populated for appropriate balun interface. R7 to R14 are provided for generic placement of matching components. To bypass the T3 and T4 baluns for differential interfacing, remove the balun interfacing resistors R19, R20, R35, R36, R41, and R42, and populate R37, R38, R39, and R40 with 0 Ω resistors.	T3, T4 = ADT8-1T+ (Mini-Circuits) C19 to C22 = 100 nF (Size 0402) C23, C24 = 0.1 μF (Size 0402) R7 to R10, R19, R20, R35, R36, R41, R42 = 0 Ω (Size 0402) R11 to R14, R37 to R40 = open (Size 0402)

Components	Function	Default Conditions
P2	Enable interface. The ADRF6516 is powered up by applying a logic high voltage to the ENBL pin (Jumper P2 is connected to VPS).	P2 = installed for enable
P1, C28, C29, R1, R29, R30, R33, R34	Serial control interface. The digital interface sets the corner frequency, the preamplifier gain, the postamplifier gain, and the VGA maximum gain of the device using the serial interface via the LE, CLK, DATA, and SDO pins. RC filter networks are provided on the CLK and LE lines to filter the PC signals. CLK, DATA, and LE signals can be observed via SMB connectors for debug purposes.	P1 = installed R1 = 10 k Ω (Size 0402) C28, C29 = 330 pF (Size 0402) R29, R30 = 100 Ω (Size 0402) R33, R34 = 0 Ω (Size 0402)
P4, C13, C14, R3	DC offset compensation loop. The dc offset compensation loop is enabled (low) with Jumper P4. When enabled, the C13 and C14 capacitors are connected to circuit common. The high-pass corner frequency is expressed as follows: $f_{HP} \text{ (Hz)} = 6.7 \times (\text{Post Filter Linear Gain}/C_{OP5} \text{ (}\mu\text{F)})$	P4 = installed C13, C14 = 1000 pF (Size 0402) R3 = 10 k Ω (Size 0402)
C27	Input common-mode setpoint. The input common-mode voltage can be set externally when applied to the VICM pin. If the VICM pin is left open, the input common-mode voltage defaults to VPS/2.	C27 = 0.1 μF (Size 0402)
C18, R6	Output common-mode setpoint. The output common-mode voltage can be set externally when applied to the VOXM pin. If the VOXM pin is left open, the output common-mode voltage defaults to VPS/2.	C18 = 0.1 μF (Size 0402) R6 = 0 Ω (Size 0402)
C17, R5	Analog gain control. The range of the GAIN pin is from 0 V to 1 V, creating a gain scaling of 15 mV/dB.	C17 = 0.1 μF (Size 0402) R5 = 0 Ω (Size 0402)
U2, U3, U4, P5	Cypress Microcontroller, EEPROM, and LDO	U2 = Microchip MICRO24LC64 U3 = Analog Devices ADP3334ACPZ U4 = Cypress Semiconductor CY7C68013A-56LTXC P5 = Mini USB connector
C35, C36, C40, C41, C42, C44, C46	3.3 V supply decoupling. Several capacitors are used for decoupling on the 3.3 V supply.	C35, C36, C40, C41, C42, C44, C46 = 0.1 μF (0402)
C48, C49, C45, C56, C57, C58, R59, R60, R61, R62, R64, CR2	Cypress and EEPROM components.	C57, C48 = 10 pF (0402) C56, C58, C45, C49 = 0.1 μF (0402) R59, R60, R61 = 2 k Ω (0402) R62, R64 = 100 k Ω (0402) CR2 = ROHM SML-21OMTT86
C47, C50, C52, R65, R69, R70, CR1	LDO components	C47, C52 = 1 μF (0402) C50 = 1000 pF (0402) R65 = 2 k Ω (0402) R69 = 78.7 k Ω (0402) R70 = 140 k Ω (0402) CR1 = ROHM SML-21OMTT86
Y1, C51, C54	Crystal oscillator and components. 24 MHz crystal oscillator.	Y1 = NDK NX3225SA-24MHz C51, C54 = 22 pF (0402)

OUTLINE DIMENSIONS

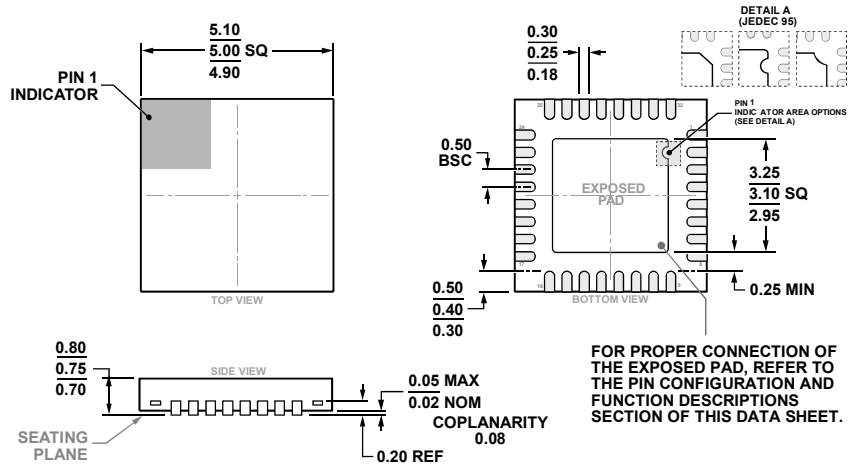

COMPLIANT TO JEDEC STANDARDS MO-220-WHHD
 Figure 62. 32-Lead Lead Frame Chip Scale Package [LFCSP]
 5 mm × 5 mm Body and 0.75 mm Package Height
 (CP-32-7)
 Dimensions shown in millimeters

ORDERING GUIDE

Model ¹	Temperature Range	Package Description	Package Option
ADRF6516ACPZ-R7	-40°C to +85°C	32-Lead LFCSP, 7" Tape and Reel	CP-32-7
ADRF6516-EVALZ		Evaluation Board	

¹ Z = RoHS Compliant Part.