



CERAMIC

Low Pass Filter

LFCN-5000D+

Mini-Circuits

50Ω DC to 5000 MHz

FEATURES

- Excellent power handling, 9W
- Small size
- 7 sections
- Temperature stable
- LTCC construction
- Protected by U.S. Patent 6,943,646



Generic photo used for illustration purposes only

CASE STYLE: FV1206

+RoHS Compliant

The +Suffix identifies RoHS Compliance. See our web site for RoHS Compliance methodologies and qualifications

APPLICATIONS

- Harmonic rejection
- VHF/UHF transmitters/receivers
- Lab use

ELECTRICAL SPECIFICATIONS^{1,2} AT 25°C

Parameter	F#	Frequency (MHz)	Min.	Typ.	Max.	Units	
Passband	Insertion Loss	DC-F1	DC-5000	—	—	1.0	dB
	Freq. Cut-Off	F2	5580	—	3.0	—	dB
	VSWR	DC-F1	DC-5000	—	1.2	—	:1
Stop Band	Rejection Loss	F3	6850	20	—	—	dB
		F4-F5	7050	—	30	—	
	VSWR	F6	18000	—	20	—	:1
		F3-F6	6850-18000	—	20	—	

1. DC Resistance to ground is 100 Mohms min.

2. Measured on Mini-Circuits Characterization Test Board TB-270.

MAXIMUM RATINGS

Parameter	Ratings
Operating temperature	-55°C to 100°C
Storage temperature	-55°C to 100°C
RF Power Input ³	9 W max. at 25°C
Max. DC Voltage at pins 1&3	25 VDC
DC Current Input to Output	0.5A max. at 25°C

3. Derate linearly to 3W at 100°C ambient.

Permanent damage may occur if any of these limits are exceeded.

TYPICAL FREQUENCY RESPONSE

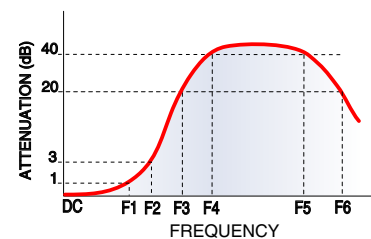

FUNCTIONAL SCHEMATIC

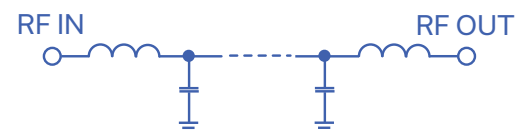

REV. C
ECO-011761
LFCN-5000D+
AD/CP/AM
220202





CERAMIC

Low Pass Filter

LFCN-5000D+

PIN CONNECTIONS

RF IN	1
RF OUT	3
GROUND	2,4

PRODUCT MARKING: N/A

DEMO BOARD MCL P/N: TB-270
SUGGESTED PCB LAYOUT (PL-137)

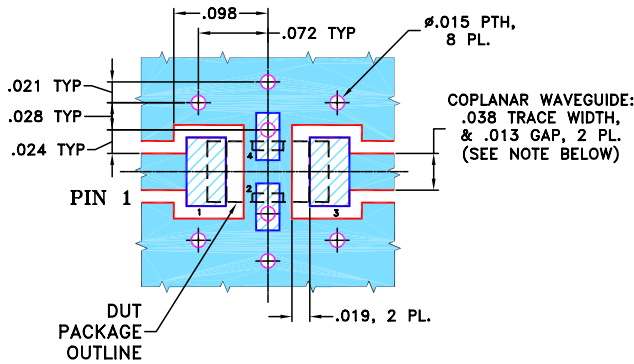

- NOTES:**
1. COPLANAR WAVEGUIDE PARAMETERS ARE SHOWN FOR ROGERS RO4350B WITH THICKNESS .020" ± .0015". COPPER: 1/2 OZ. EACH SIDE. FOR OTHER MATERIALS TRACE WIDTH & GAP MAY NEED TO BE MODIFIED.
 2. BOTTOM SIDE OF THE PCB IS CONTINUOUS GROUND PLANE.

- DENOTES PCB COPPER LAYOUT WITH SMOBC (SOLDER MASK OVER BARE COPPER)
- DENOTES COPPER LAND PATTERN FREE OF SOLDER MASK

OUTLINE DRAWING

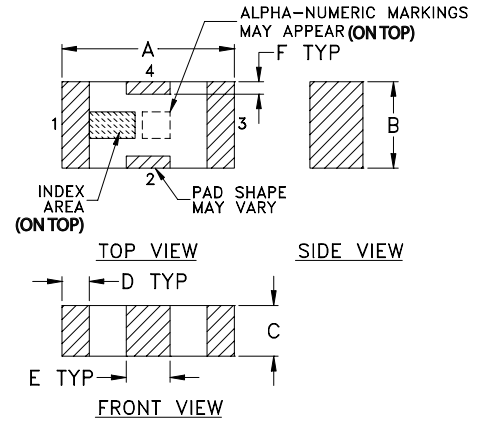

PCB Land Pattern

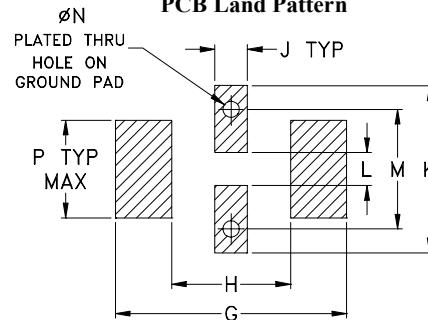

Suggested Layout,
Tolerance to be within ±.002

OUTLINE DIMENSIONS (Inches mm)

A	B	C	D	E	F	G
.126	.063	.037	.020	.032	.009	.169
3.20	1.60	0.94	0.51	0.81	0.23	4.29

H	J	K	L	M	N	P	wt
.087	.024	.122	.024	.087	.012	.071	grams
2.21	0.61	3.10	0.61	2.21	0.30	1.80	.020

TAPE & REEL INFORMATION: F71



CERAMIC

Low Pass Filter

LFCN-5000D+

TYPICAL PERFORMANCE DATA AT 25°C

Frequency (MHz)	Insertion Loss (dB)	VSWR (:1)
50.00	0.01	1.01
500.00	0.10	1.03
1000.00	0.14	1.04
2000.00	0.26	1.07
3000.00	0.31	1.15
4000.00	0.51	1.25
5000.00	0.68	1.05
5800.00	4.91	5.30
6830.00	40.67	22.58
8000.00	28.12	31.03
11000.00	32.43	157.93
13000.00	25.15	1.71
15000.00	24.88	29.46
18000.00	18.17	26.33
20000.00	23.63	8.43

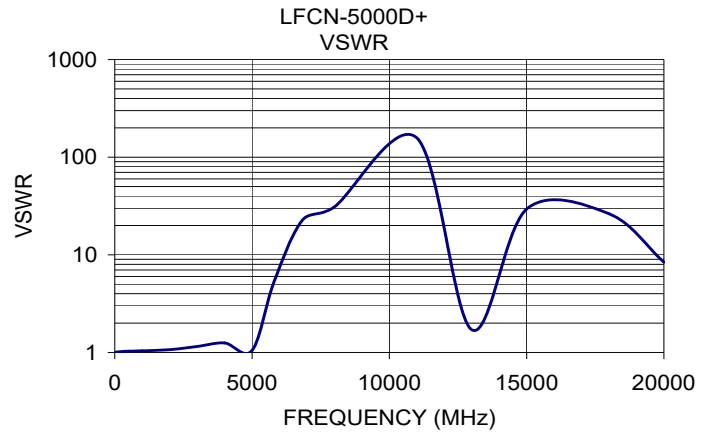
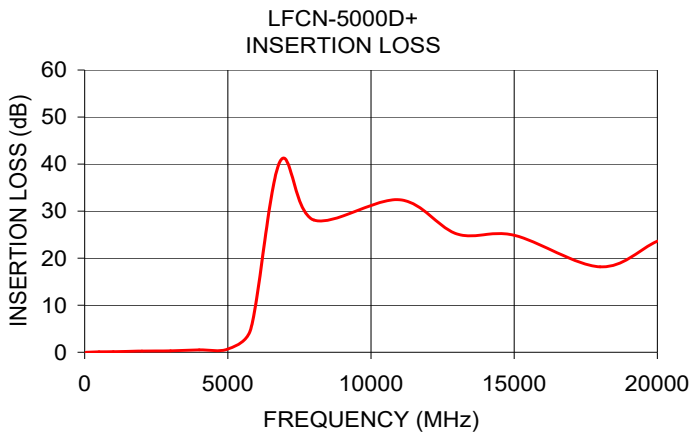

NOTES

- A. Performance and quality attributes and conditions not expressly stated in this specification document are intended to be excluded and do not form a part of this specification document.
- B. Electrical specifications and performance data contained in this specification document are based on Mini-Circuit's applicable established test performance criteria and measurement instructions.
- C. The parts covered by this specification document are subject to Mini-Circuits standard limited warranty and terms and conditions (collectively, "Standard Terms"); Purchasers of this part are entitled to the rights and benefits contained therein. For a full statement of the standard. Terms and the exclusive rights and remedies thereunder, please visit Mini-Circuits' website at www.minicircuits.com/MCLStore/terms.jsp

