

# FAN5340

## Synchronous Constant-Current Series Boost LED Driver with PWM Brightness Control and Integrated Load Disconnect

### Features

- Synchronous Current-Mode Boost Converter
- Up to 500mW Output Power
- Supports 2, 3, or 4 LEDs in Series
- 2.7V to 4.8V Input Voltage Range
- 1.2MHz Fixed Switching Frequency
- 1mA Maximum Quiescent Current
- Soft-Start Capability
- Input Under-Voltage Lockout (UVLO)
- Output Over-Voltage Protection (OVP)
- Short-Circuit Detection
- Thermal Shutdown (TSD) Protection
- 8-Lead 3.00 x 3.00mm MLP
- 8-Bump 1.57 x 1.57mm WLCSP

### Applications

- Cellular Phones, Smart Phones
- Pocket PCs
- WLAN DC-DC Converter Modules
- PDA, DSC, PMP, and MP3 Players

### Description

The FAN5340 is a synchronous constant-current LED driver capable of efficiently delivering up to 500mW to a string of up to four LEDs in series. Optimized for small form-factor applications, the 1.2MHz fixed switching frequency allows the use of chip inductors and capacitors.

For safety, the device features integrated short-circuit detection plus over-voltage and thermal shutdown protections. In addition, input under-voltage lockout protection is triggered if the battery voltage is low.

Brightness (dimming) control is implemented by applying a PWM signal of 300Hz to 1kHz on the EN pin. During shutdown, the FAN5340 disconnects the LED anodes from the output of the boost regulator, which holds the boost regulator's voltage on C<sub>OUT</sub>, reducing audible noise from the PWM dimming and removing power from the LED string.

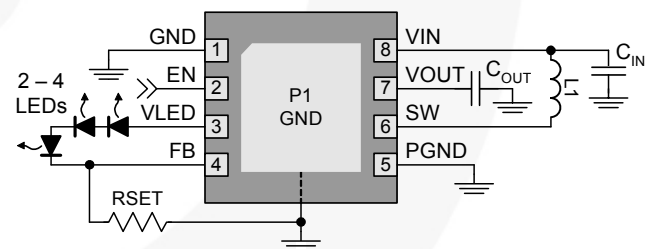

Figure 1. Typical Application

### Ordering Information

Part Number	Operating Temperature Range	Package	Packing
FAN5340UCX	-40 to 85°C	8-Bump, 1.57 x 1.57mm Wafer Level Chip-Scale Package (WLCSP)	Tape and Reel
FAN5340MPX (Preliminary)	-40 to 85°C	8-Lead, 3.00 x 3.00mm Molded Leadless Package (MLP)	Tape and Reel

## Block Diagrams

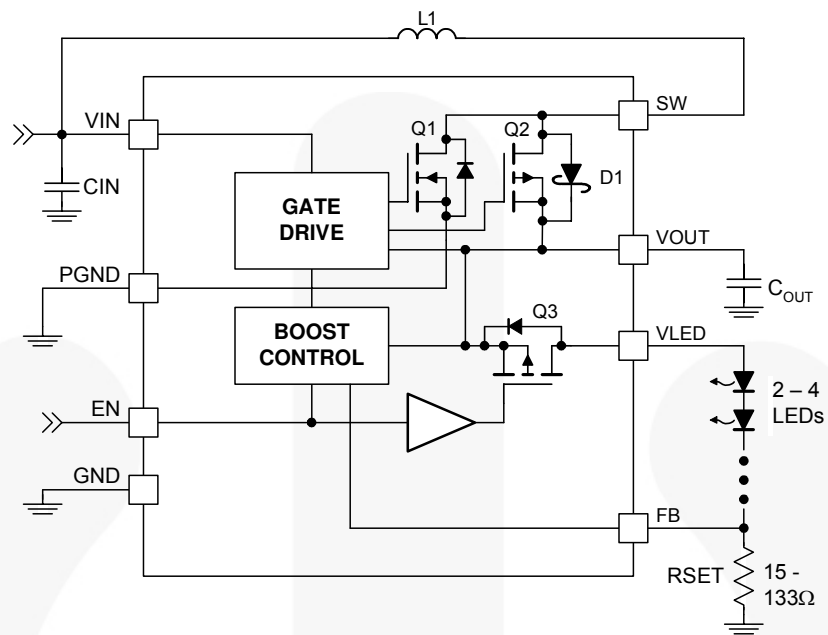

Figure 2. Block Diagram

Table 1. Recommended External Components

Component	Description	Vendor	Parameter	Min.	Typ.	Max.	Units
L1	22 $\mu$ H Nominal	Murata LQH3NPN220MGOK	L <sup>(1)</sup>		22		$\mu$ H
			DCR (Series R)		1100		m $\Omega$
C <sub>OUT</sub>	4.7 $\mu$ F X5R or Better		C		4.7		$\mu$ F
C <sub>IN</sub>	4.7 $\mu$ F X5R or Better		C		4.7		$\mu$ F

**Note:**

1. Minimum L (inductance) incorporates tolerance, temperature, and DC bias effects (L decreases with increasing current).

## Pin Configuration

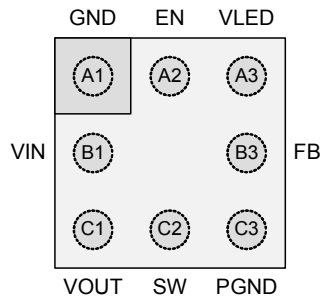

Figure 3. WLCSP Package, Top View

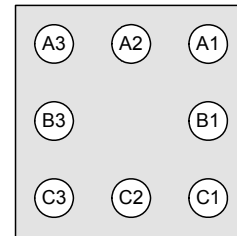

Figure 4. WLCSP Package, Bottom View

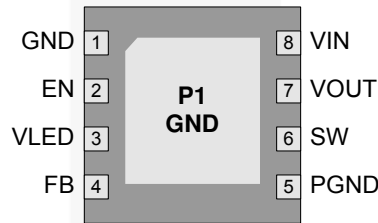

Figure 5. 8-Pin 3 x 3mm MLP, Top View

## Pin Definitions

Pin #		Name	Description
CSP	MLP		
A1	1	GND	<b>Analog Ground.</b> All signals are referenced to this pin.
A2	2	EN	<b>Enable / PWM Brightness Control.</b> A logic LOW on this pin shuts down the IC, disconnects the LEDs from VOUT, and reduces the current consumption of the IC. This terminal has an internal pull-down resistor of 300kΩ.
A3	3	VLED	<b>LED String Output.</b> Connected to the anode of a series string of two to four LEDs.
B3	4	FB	<b>Current Feedback.</b> The boost regulator regulates this pin to 0.5V to control the LED string current. Tie this pin via a current-setting resistor ( $R_{SET}$ ) to GND and the cathode of the LED string.
C3	5	PGND	<b>Power Ground.</b> The boost switch and gate drivers are grounded at this pin.
C2	6	SW	<b>Switching Node.</b> Tie inductor L1 from $V_{IN}$ to this pin.
C1	7	VOUT	<b>Boost Output Voltage.</b> Output of the boost regulator.
B1	8	VIN	<b>Input Voltage.</b>

## Absolute Maximum Ratings

Stresses exceeding the absolute maximum ratings may damage the device. The device may not function or be operable above the recommended operating conditions and stressing the parts to these levels is not recommended. In addition, extended exposure to stresses above the recommended operating conditions may affect device reliability. The absolute maximum ratings are stress ratings only.

Symbol	Parameter	Min.	Max.	Units	
$V_{IN}$	VIN	-0.3	6.0	V	
$V_{FB}, V_{EN}$	FB, EN Pins	-0.3	$V_{IN} + 0.3$	V	
$V_{SW}$	SW Pin	-0.3	24.0	V	
$V_{OUT}$	VOUT Pin	-0.3	24.0	V	
ESD	Electrostatic Discharge Protection Level	Human Body Model per JESD22-A114	4.0		kV
		Charged Device Model per JESD22-C101	1.5		
$T_J$	Junction Temperature	-40	+150	°C	
$T_{STG}$	Storage Temperature	-65	+150	°C	
$T_L$	Lead Soldering Temperature, 10 Seconds		+260	°C	

## Recommended Operating Conditions

The Recommended Operating Conditions table defines the conditions for actual device operation. Recommended operating conditions are specified to ensure optimal performance to the datasheet specifications. Fairchild does not recommend exceeding them or designing to absolute maximum ratings.

Symbol	Parameter	Min.	Typ.	Max.	Units
$V_{IN}$	VIN Supply Voltage	2.7		4.8	V
$V_{OUT}$	VOUT Voltage	6.2		16.0	V
$I_{OUT}$	VOUT Load Current	5		40	mA
$f_{EN\_PWM}$	EN pin PWM Dimming Frequency	100	300	1000	Hz
$T_A$	Ambient Temperature	-40		+85	°C
$T_J$	Junction Temperature	-40		+125	°C

## Thermal Properties

Junction-to-ambient thermal resistance is a function of application and board layout. This data is measured with four-layer 2s2p evaluation boards in accordance to JEDEC standard JESD51. Special attention must be paid not to exceed junction temperature  $T_{J(max)}$  at a given ambient temperature  $T_A$ .

Symbol	Parameter	Typ.	Units
$\theta_{JA}$	Junction-to-Ambient Thermal Resistance	WLCSP Package	110 °C/W
		MLP Package	49 °C/W

## Electrical Specifications

$V_{IN} = 2.7V$  to  $4.8V$  and  $T_A = -40^{\circ}C$  to  $+85^{\circ}C$  unless otherwise noted. Typical values are at  $T_A = 25^{\circ}C$  and  $V_{IN} = 3.6V$ .

Symbol	Parameter	Conditions	Min.	Typ.	Max.	Units
<b>Power Supplies</b>						
$I_Q$	Quiescent Current	EN = $V_{IN}$ , Device Not Switching			1	mA
$I_{SD}$	Shutdown Supply Current	EN = GND, $V_{IN} = 3.6V$		0.3	1.0	$\mu A$
$V_{UVLO}$	Under-Voltage Lockout	$V_{IN}$ Rising	2.30	2.40	2.50	V
		$V_{IN}$ Falling	2.00	2.15	2.25	V
$V_{UVHYST}$	Under-Voltage Lockout Hysteresis			250		mV
<b>EN: Enable Pin</b>						
$V_{IH}$	HIGH-Level Input Voltage		1.2			V
$V_{IL}$	LOW-Level Input Voltage				0.4	V
$R_{EN}$	EN Pull-Down Resistance		200	300	400	$k\Omega$
$t_{SD}$	EN Low to Shutdown Delay	From Falling Edge of EN	20		80	ms
<b>Feedback and Reference</b>						
$V_{FB}$	Feedback Voltage		480	500	520	mV
$I_{FB}$	Feedback Input Current	$V_{FB} = 500mV$		0.1	1.0	$\mu A$
<b>Power Outputs</b>						
$R_{DS(ON)_Q1}$	Boost Switch On-Resistance	$V_{IN} = 3.6V, V_{OUT} = 10V, I_{SW} = 100mA$		600		$m\Omega$
		$V_{IN} = 2.7V, V_{OUT} = 10V, I_{SW} = 100mA$		850		
$R_{DS(ON)_Q2}$	Synchronous Rectifier On-Resistance	$V_{OUT} = 10V, I_{SW} = 100mA$		2.0		$\Omega$
$R_{DS(ON)_Q3}$	Load Switch On-Resistance	$V_{OUT} = 10V, I_{LED} = 10mA$		2.8		$\Omega$
$I_{SW(OFF)}$	SW Node Leakage <sup>(2)</sup>	EN = 0, $V_{IN} = V_{SW} = V_{OUT} = 5.5V$ , $V_{LED} = 0$		0.1	1.0	$\mu A$
$I_{LIM-PK}$	Boost Switch Peak Current Limit	$V_{IN} = 3.6V$	325	400	475	mA
<b>Oscillator</b>						
$f_{SW}$	Boost Regulator Switching Frequency		1.0	1.2	1.4	MHz
<b>PWM Dimming</b>						
$D_{PWM}$	PWM Duty Cycle <sup>(3)</sup>	PWM Dimming Frequency $\leq 1kHz$	1.0		100	%
<b>Output and Protection</b>						
$V_{OVP}$	Boost Output Over-Voltage Protection		18.0	19.0	20.0	V
$V_{OVPHYST}$	OVP Hysteresis			0.8		V
$V_{THSC}$	$V_{LED}$ Short-Circuit Detection Threshold	$V_{OUT}$ Falling		$V_{IN} - 1.5$		V
		$V_{OUT}$ Rising		$V_{IN} - 1.3$		V
$D_{MAX}$	Maximum Boost Duty Cycle <sup>(3)</sup>		85			%
$D_{MIN}$	Minimum Boost Duty Cycle <sup>(3)</sup>				20	%
$T_{SD}$	Thermal Shutdown			150		$^{\circ}C$
$T_{HYS}$	Thermal Shutdown Hysteresis			25		$^{\circ}C$

### Notes:

- SW leakage current includes the leakage current of three internal switches; SW to GND,  $V_{OUT}$  to  $V_{LED}$ , and SW to  $V_{OUT}$ .
- Guaranteed by design.

## Typical Characteristics

$V_{IN} = 3.6V$ ,  $T_A = 25^\circ C$ ,  $I_{LED} = 20mA$ ,  $L = 22\mu H$ ,  $C_{OUT} = 4.7\mu F$ .

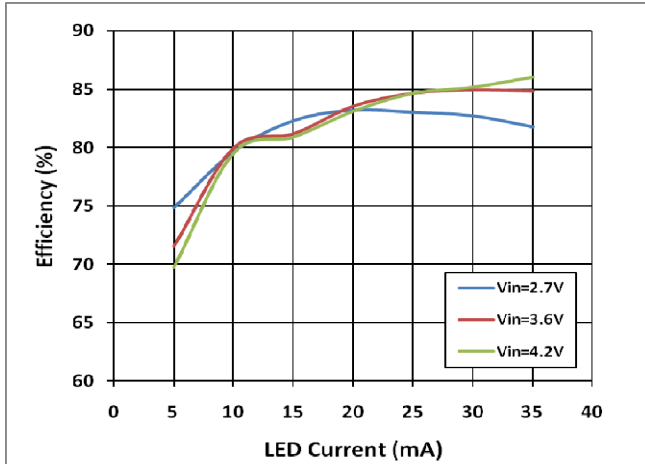

Figure 6. Efficiency vs. LED Current: Two LEDs

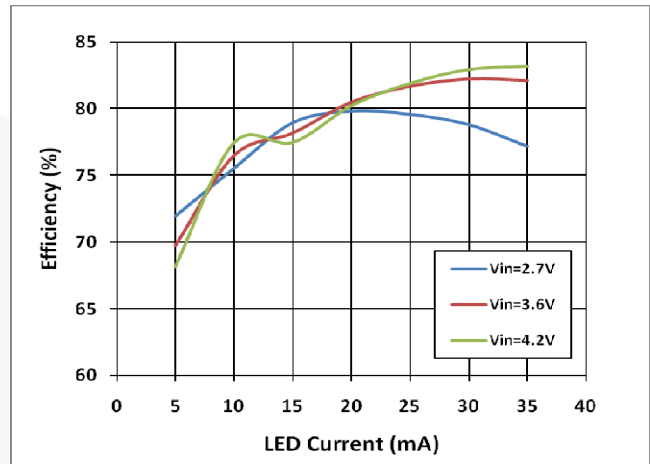

Figure 7. Efficiency vs. LED Current: Three LEDs

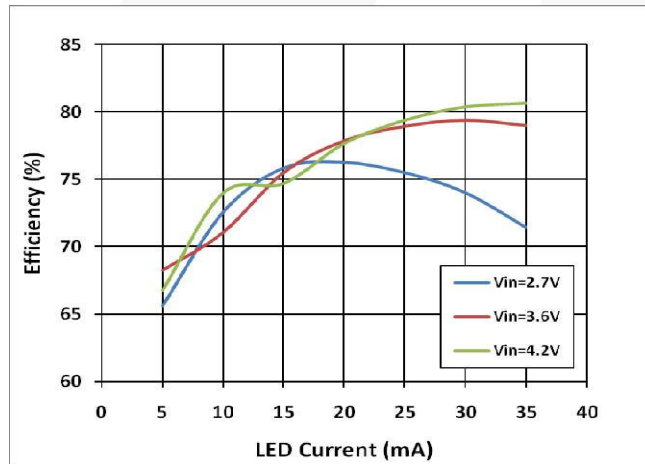

Figure 8. Efficiency vs. LED Current: Four LEDs

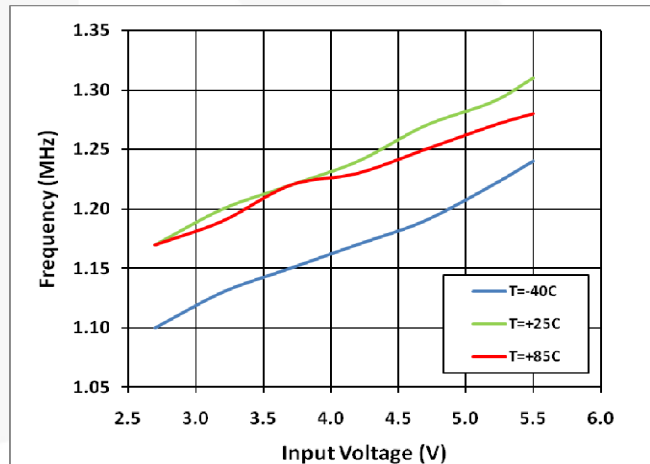

Figure 9.  $f_{sw}$  vs. Input Voltage vs. Temperature

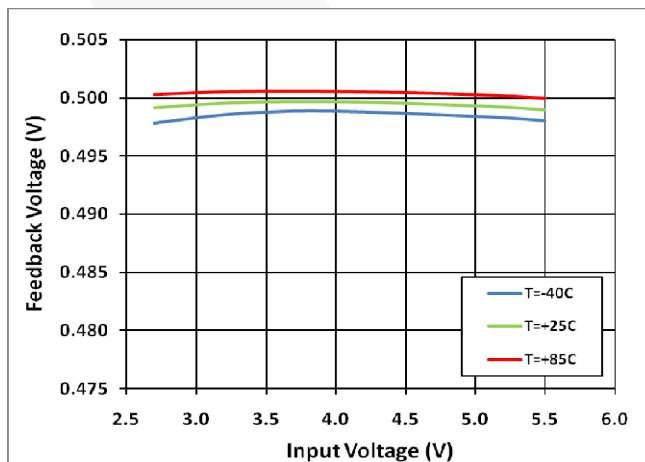

Figure 10. FB Voltage vs. Input Voltage vs. Temperature

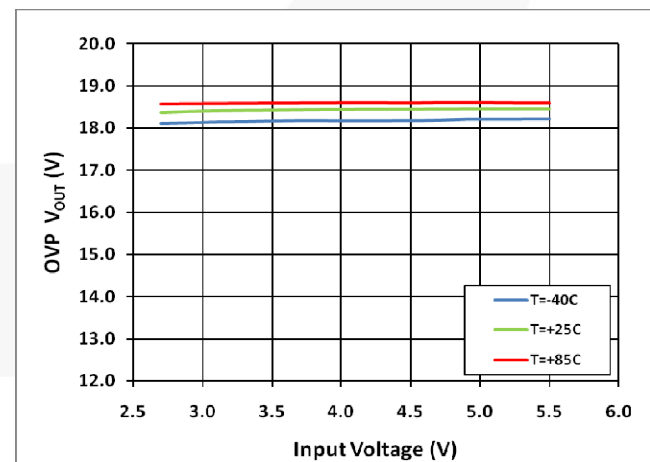

Figure 11. OVP vs. Input Voltage vs. Temperature

Typical Characteristics (Continued)

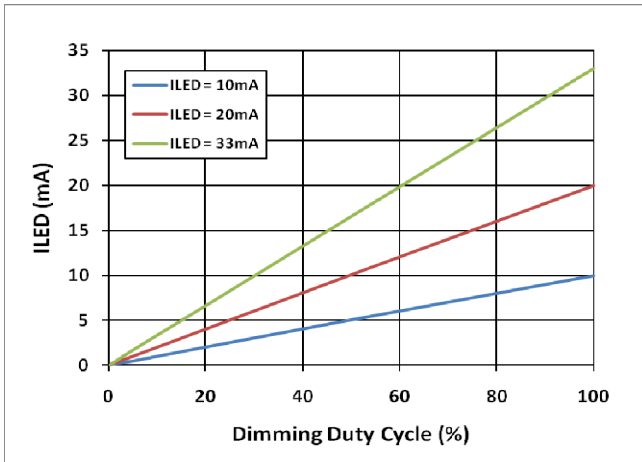

Figure 12. PWM Linearity Over Full Dimming Duty Cycle Range, Four LEDs

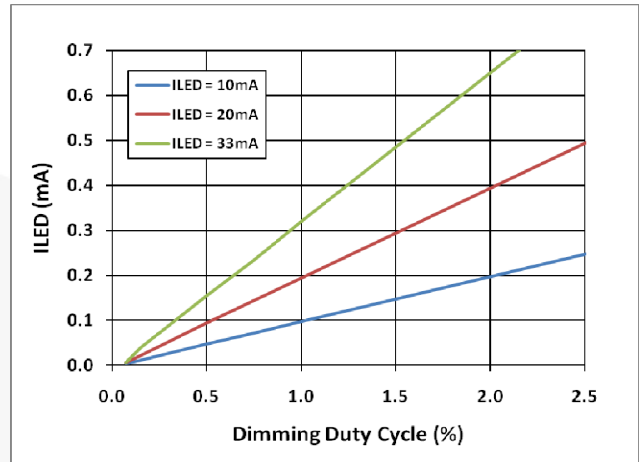

Figure 13. PWM Linearity with Dimming Duty Cycle <2.5%, Four LEDs

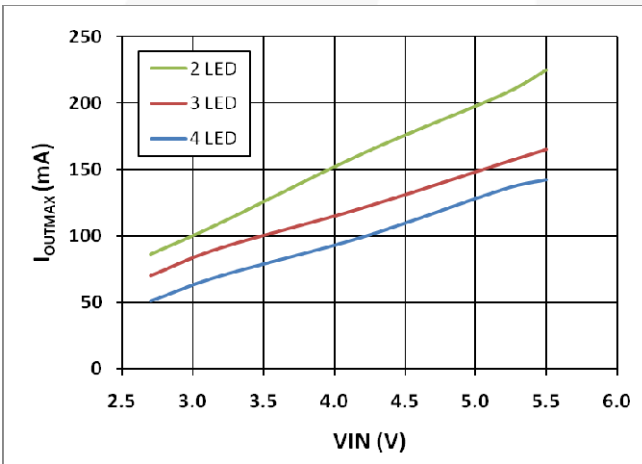

Figure 14. Maximum Output Current at VOUT

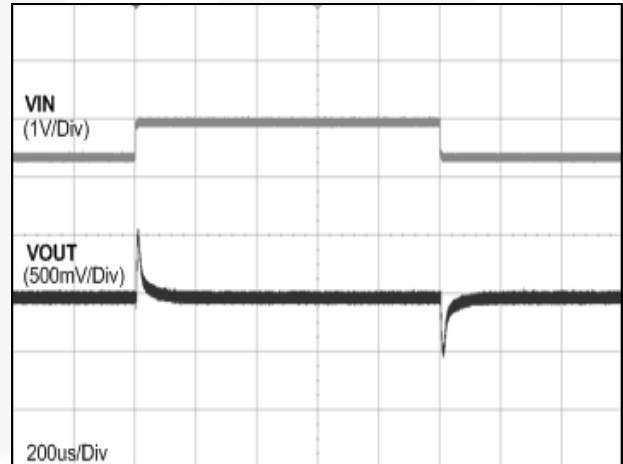

Figure 15. Line Transient with 10µs Line Step, Four LEDs

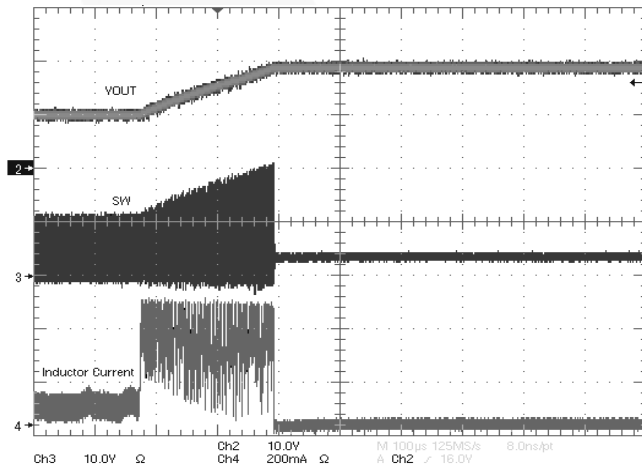
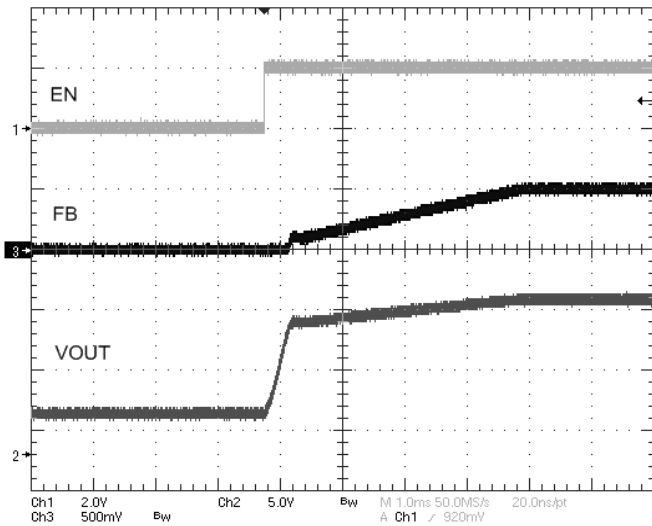
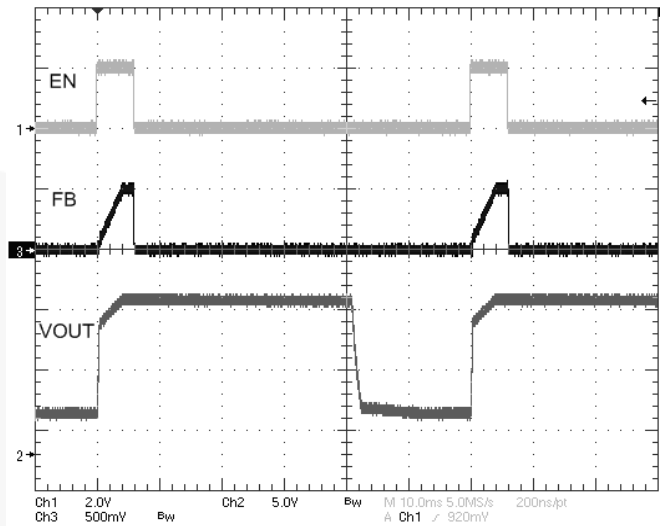

Figure 16. Over-Voltage Protection: Soft-Start into Open LED String

**Typical Characteristics** (Continued)



**Figure 17. Cold-Start Waveform with 100% Duty Cycle at 1ms/Div.**



**Figure 18. Cold-Start Waveform with 100% Duty Cycle Showing Startup, Shutdown and Startup at 10ms/Div**

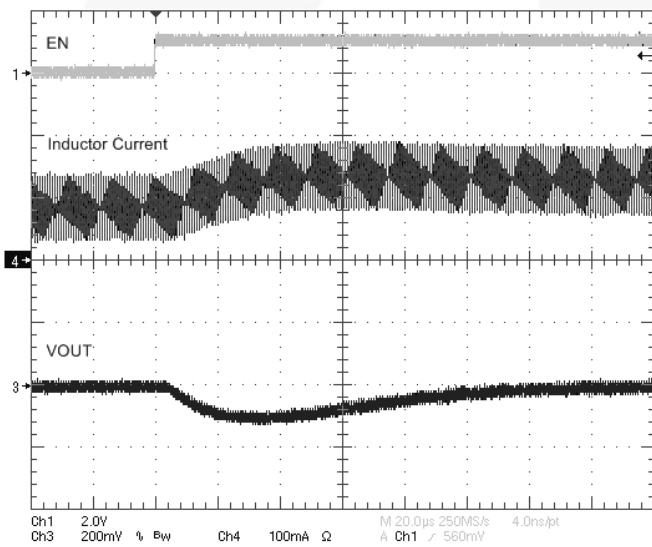

**Figure 19. FAN5340  $I_{LOAD}$  Step from 20mA to 30mA by Enabling FAN5640 at 10mA, Three LEDs**

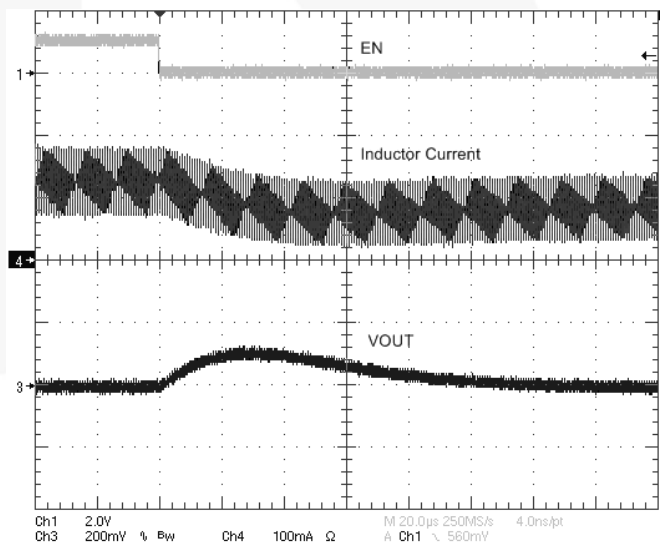

**Figure 20. FAN5340  $I_{LOAD}$  Step from 30mA to 20mA by Disabling FAN5640 at 10mA, Three LEDs**





## Circuit Description

### Overview

The FAN5340 is an inductive current-mode boost serial LED driver that achieves LED current regulation by maintaining 0.5V across  $R_{SET}$ . The current through the LED string ( $I_{LED}$ ) is therefore:

$$I_{LED} = \frac{0.5}{R_{SET}} \quad (1)$$

While the forward-voltage across the LEDs determines  $V_{OUT}$ , the FAN5340's boost regulator output can also support additional loads on  $V_{OUT}$  (see Figure 21) provided its input current limit is not exceeded.

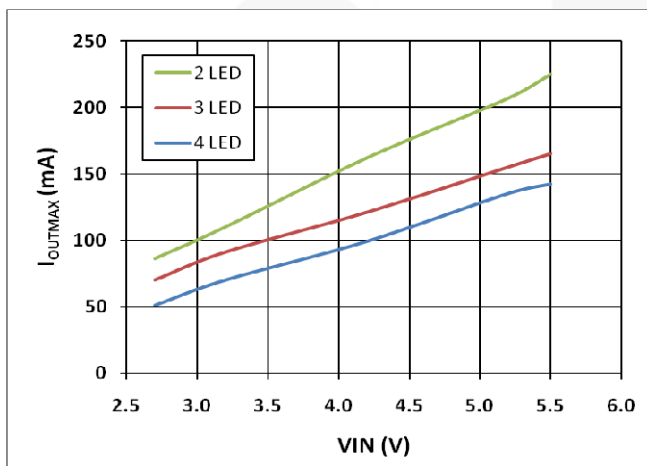

Figure 21. Maximum Output Current vs. Input Voltage

### UVLO and Soft-Start

If EN has been LOW for more than 20ms, the IC initiates a “cold start” soft-start cycle when EN rises, provided  $V_{IN}$  is above the UVLO threshold. The soft-start circuit ramps the voltage reference to the error amplifier to control inrush current.

### PWM Dimming

When EN goes LOW, the IC turns off a MOSFET (Q3 in Figure 2), which disconnects the LED load, preventing  $C_{OUT}$  from being discharged when EN is LOW. As long as EN is low for less than 20ms, the regulator's main regulation loop quickly regains control when EN returns to a HIGH state.

### Short-Circuit Detection

If  $V_{OUT}$  falls below  $V_{IN} - 1.5V$ , Q3 turns off and remains off until  $V_{OUT}$  recovers to at least  $V_{IN} - 1.3V$ .

### Over-Voltage Protection

If the LED string is open circuit, FB remains at 0V and the output voltage continues to increase in the absence of an Over-Voltage Protection (OVP) circuit. The FAN5340's OVP circuit disables the boost regulator when  $V_{OUT}$  exceeds 19.0V and continues to keep the regulator off until  $V_{OUT}$  drops below 18.2V.

### Thermal Shutdown

If the die temperature exceeds 150°C, a reset occurs and remains in effect until the die cools to 125°C, at which time the circuit is allowed to begin the soft-start sequence.

## Applications

### Using VOUT to Drive Additional LED Strings

The VOUT pin can be used as a supply for simple current sources (shown in Figure 22 using the FAN5640) or discrete current sinks. To avoid dragging  $V_{OUT}$  down when the EN pin is LOW, the auxiliary strings should not be enabled unless the EN pin is HIGH. The auxiliary strings can therefore be PWM dimmed using either the same line as the EN line as shown below or enabled separately, but within the on-time of the FAN5340.

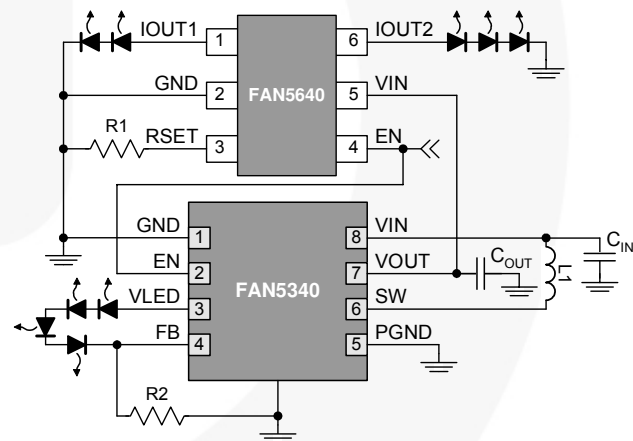
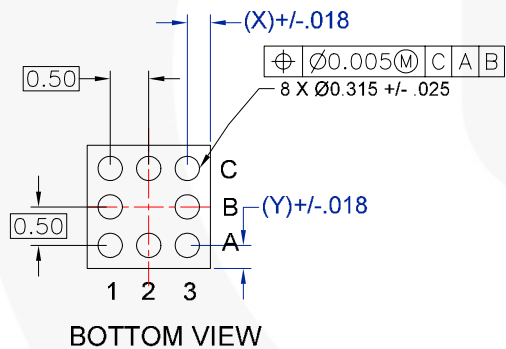
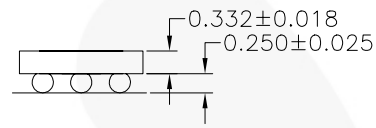
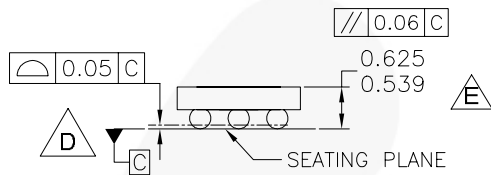
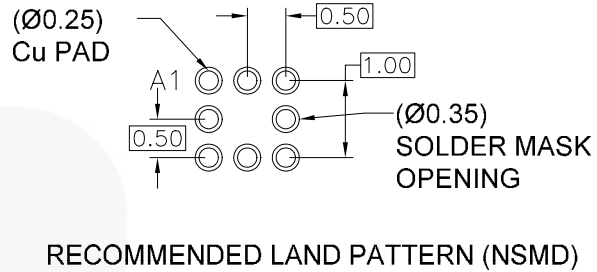
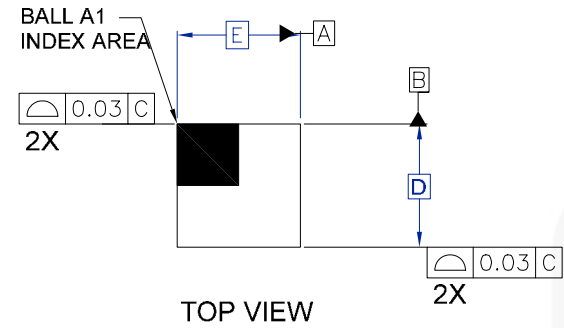

Figure 22. Driving Additional LED Strings

If using  $V_{OUT}$  to drive additional loads, care should be taken not to exceed the input current limit. This limitation is shown in Figure 21 for a typical IC. The total load ( $I_{OUT1} + I_{OUT2} + I_{LED}$ ) should always remain below 70% of the value in Figure 21.

## Physical Dimensions



### NOTES:

- A. NO JEDEC REGISTRATION APPLIES.
- B. DIMENSIONS ARE IN MILLIMETERS.
- C, DIMENSIONS AND TOLERANCES PER ASME Y14.5M, 1994
- D. DATUM C, THE SEATING PLANE, IS DEFINED BY THE SPHERICAL CROWNS OF THE BALLS.
- E. PACKAGE TYPICAL HEIGHT IS 582 MICRONS ± 43 MICRONS (539-625 MICRONS).
- F. FOR DIMENSIONS D, E, X, AND Y SEE PRODUCT DATASHEET.
- G. BALL COMPOSITION: Sn95.5-Ag3.9-Cu0.6
- I. DRAWING FILENAME: MKT-UC008ABrev2.

## Product-Specific Dimensions

Product	D	E	X	Y
FAN5340UC	1.570	1.570	0.285	0.285

**Figure 23. 8-Bump, 1.57 x 1.57mm Wafer Level Chip-Scale Package (WLCSP)**

Package drawings are provided as a service to customers considering Fairchild components. Drawings may change in any manner without notice. Please note the revision and/or date on the drawing and contact a Fairchild Semiconductor representative to verify or obtain the most recent revision. Package specifications do not expand the terms of Fairchild's worldwide terms and conditions, specifically the warranty therein, which covers Fairchild products.

Always visit Fairchild Semiconductor's online packaging area for the most recent package drawings:  
<http://www.fairchildsemi.com/packaging/>

**Physical Dimensions (Continued)**

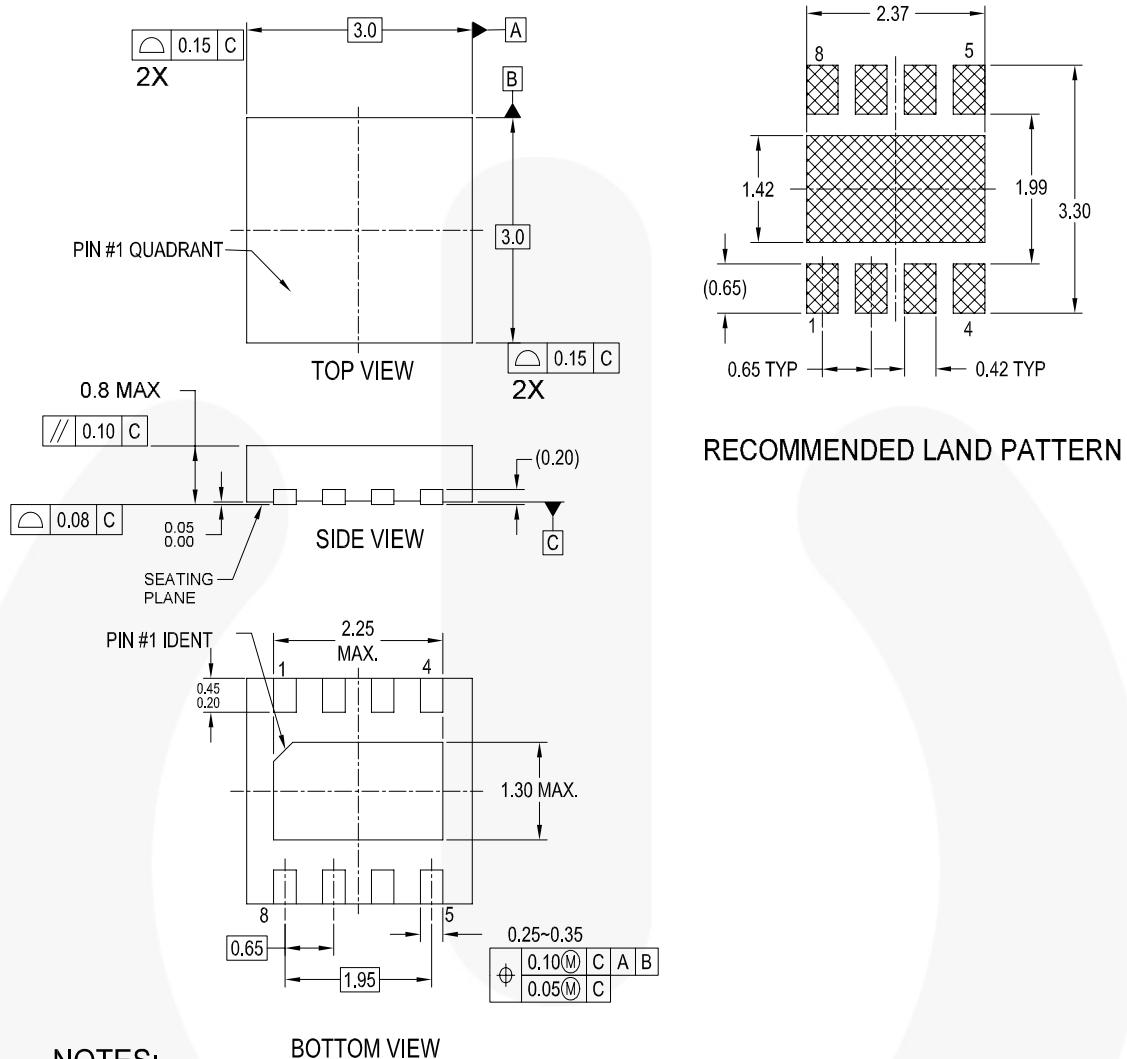

**NOTES:**

- A. CONFORMS TO JEDEC REGISTRATION MO-229, VARIATION VEEC, DATED 11/2001
- B. DIMENSIONS ARE IN MILLIMETERS.
- C. DIMENSIONS AND TOLERANCES PER ASME Y14.5M, 1994
- D. FILENAME: MKT-MLP08Drev2

**Figure 24. 8-Pin, 3 x 3mm Molded Leadless Package (MLP)**

Package drawings are provided as a service to customers considering Fairchild components. Drawings may change in any manner without notice. Please note the revision and/or date on the drawing and contact a Fairchild Semiconductor representative to verify or obtain the most recent revision. Package specifications do not expand the terms of Fairchild's worldwide terms and conditions, specifically the warranty therein, which covers Fairchild products.

Always visit Fairchild Semiconductor's online packaging area for the most recent package drawings:  
<http://www.fairchildsemi.com/packaging/>



**TRADEMARKS**

The following includes registered and unregistered trademarks and service marks, owned by Fairchild Semiconductor and/or its global subsidiaries, and is not intended to be an exhaustive list of all such trademarks.

AccuPower™  
 Auto-SPM™  
 Build it Now™  
 CorePLUS™  
 CorePOWER™  
 CROSSVOL7™  
 CTL™  
 Current Transfer Logic™  
 DEUXPEED®  
 Dual Cool™  
 EcoSPARK®  
 EfficientMax™  
 ESBC™  
  
 Fairchild®  
 Fairchild Semiconductor®  
 FACT Quiet Series™  
 FACT®  
 FAST®  
 FastvCore™  
 FETBench™  
 FlashWriter®  
 FPS™

F-PFST™  
 FRFET®  
 Global Power Resource™  
 Green FPS™  
 Green FPS™ e-Series™  
 Gmax™  
 GTO™  
 IntelliMAX™  
 ISOPLANAR™  
 MegaBuck™  
 MICROCOUPLER™  
 MicroFET™  
 MicroPak™  
 MicroPak2™  
 MillerDrive™  
 MotionMax™  
 Motion-SPM™  
 OptoHiT™  
 OPTOLOGIC®  
 OPTOPLANAR®  
  
 PDP SPM™

Power-SPM™  
 PowerTrench®  
 PowerXS™  
 Programmable Active Droop™  
 QFET®  
 QST™  
 Quiet Series™  
 RapidConfigure™  
  
 Saving our world, 1mW/W/kW at a time™  
 SignalWise™  
 SmartMax™  
 SMART START™  
 SPM®  
 STEALTH™  
 SuperFET™  
 SuperSOT™-3  
 SuperSOT™-6  
 SuperSOT™-8  
 SupreMOS™  
 SyncFET™  
 Sync-Lock™

  
 SYSTEM GENERAL®  
 The Power Franchise®  
  
 the power franchise®  
 TinyBoost™  
 TinyBuck™  
 TinyCalc™  
 TinyLogic®  
 TINYOPTO™  
 TinyPower™  
 TinyPWM™  
 TinyWire™  
 TriFault Detect™  
 TRUECURRENT™\*  
 u.SerDes™  
  
 SerDes™  
 UHC®  
 Ultra FRFET™  
 UniFET™  
 VCX™  
 VisualMax™  
 XS™

\* Trademarks of System General Corporation, used under license by Fairchild Semiconductor.

**DISCLAIMER**

FAIRCHILD SEMICONDUCTOR RESERVES THE RIGHT TO MAKE CHANGES WITHOUT FURTHER NOTICE TO ANY PRODUCTS HEREIN TO IMPROVE RELIABILITY, FUNCTION, OR DESIGN. FAIRCHILD DOES NOT ASSUME ANY LIABILITY ARISING OUT OF THE APPLICATION OR USE OF ANY PRODUCT OR CIRCUIT DESCRIBED HEREIN; NEITHER DOES IT CONVEY ANY LICENSE UNDER ITS PATENT RIGHTS, NOR THE RIGHTS OF OTHERS. THESE SPECIFICATIONS DO NOT EXPAND THE TERMS OF FAIRCHILD'S WORLDWIDE TERMS AND CONDITIONS, SPECIFICALLY THE WARRANTY THEREIN, WHICH COVERS THESE PRODUCTS.

**LIFE SUPPORT POLICY**

FAIRCHILD'S PRODUCTS ARE NOT AUTHORIZED FOR USE AS CRITICAL COMPONENTS IN LIFE SUPPORT DEVICES OR SYSTEMS WITHOUT THE EXPRESS WRITTEN APPROVAL OF FAIRCHILD SEMICONDUCTOR CORPORATION.

As used herein:

1. Life support devices or systems are devices or systems which, (a) are intended for surgical implant into the body or (b) support or sustain life, and (c) whose failure to perform when properly used in accordance with instructions for use provided in the labeling, can be reasonably expected to result in a significant injury of the user.
2. A critical component in any component of a life support, device, or system whose failure to perform can be reasonably expected to cause the failure of the life support device or system, or to affect its safety or effectiveness.

**ANTI-COUNTERFEITING POLICY**

Fairchild Semiconductor Corporation's Anti-Counterfeiting Policy. Fairchild's Anti-Counterfeiting Policy is also stated on our external website, [www.fairchildsemi.com](http://www.fairchildsemi.com), under Sales Support.

Counterfeiting of semiconductor parts is a growing problem in the industry. All manufacturers of semiconductor products are experiencing counterfeiting of their parts. Customers who inadvertently purchase counterfeit parts experience many problems such as loss of brand reputation, substandard performance, failed applications, and increased cost of production and manufacturing delays. Fairchild is taking strong measures to protect ourselves and our customers from the proliferation of counterfeit parts. Fairchild strongly encourages customers to purchase Fairchild parts either directly from Fairchild or from Authorized Fairchild Distributors who are listed by country on our web page cited above. Products customers buy either from Fairchild directly or from Authorized Fairchild Distributors are genuine parts, have full traceability, meet Fairchild's quality standards for handling and storage and provide access to Fairchild's full range of up-to-date technical and product information. Fairchild and our Authorized Distributors will stand behind all warranties and will appropriately address any warranty issues that may arise. Fairchild will not provide any warranty coverage or other assistance for parts bought from Unauthorized Sources. Fairchild is committed to combat this global problem and encourage our customers to do their part in stopping this practice by buying direct or from authorized distributors.

**PRODUCT STATUS DEFINITIONS**

**Definition of Terms**

Datasheet Identification	Product Status	Definition
Advance Information	Formative / In Design	Datasheet contains the design specifications for product development. Specifications may change in any manner without notice.
Preliminary	First Production	Datasheet contains preliminary data; supplementary data will be published at a later date. Fairchild Semiconductor reserves the right to make changes at any time without notice to improve design.
No Identification Needed	Full Production	Datasheet contains final specifications. Fairchild Semiconductor reserves the right to make changes at any time without notice to improve the design.
Obsolete	Not In Production	Datasheet contains specifications on a product that is discontinued by Fairchild Semiconductor. The datasheet is for reference information only.

Rev. 148