

ORDER NO.	WOODHEAD NO.	COLOR
130147-0227	26W48-P	YELLOW

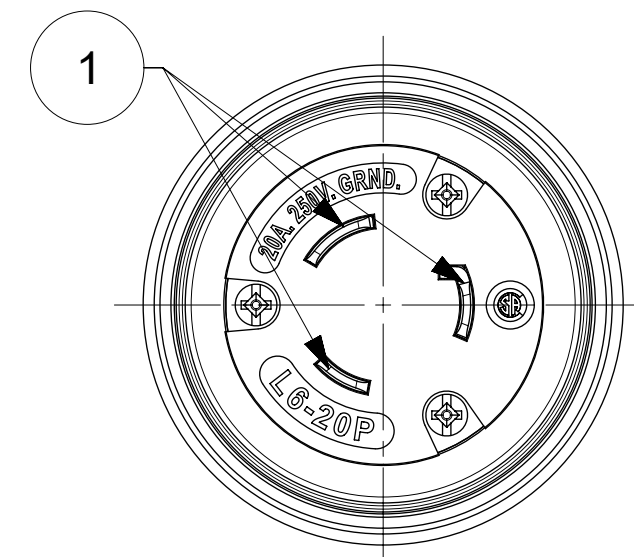

FACE VIEW

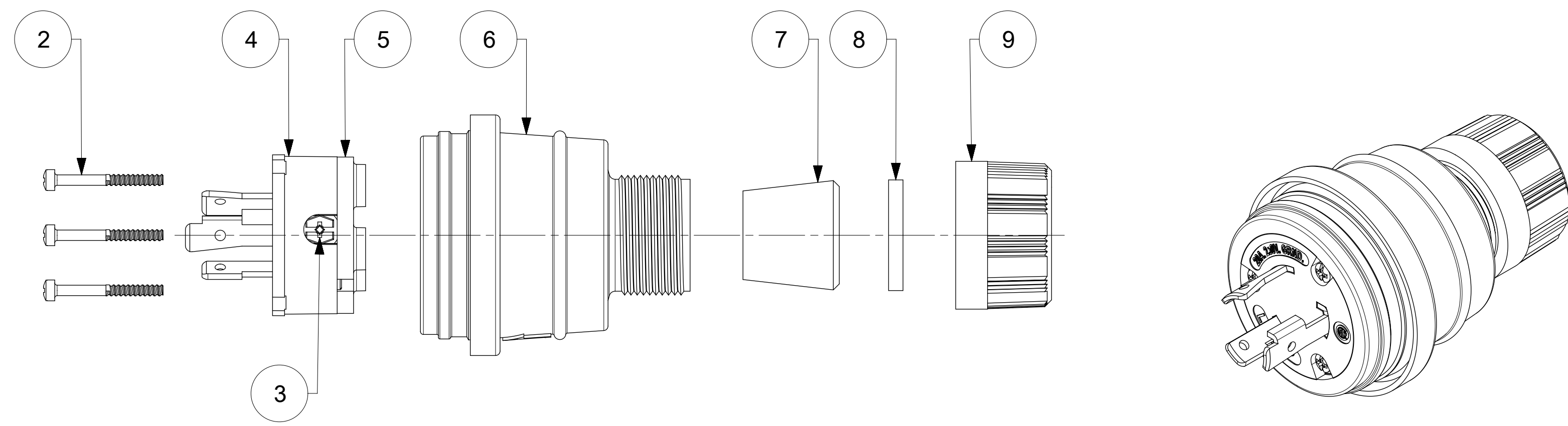
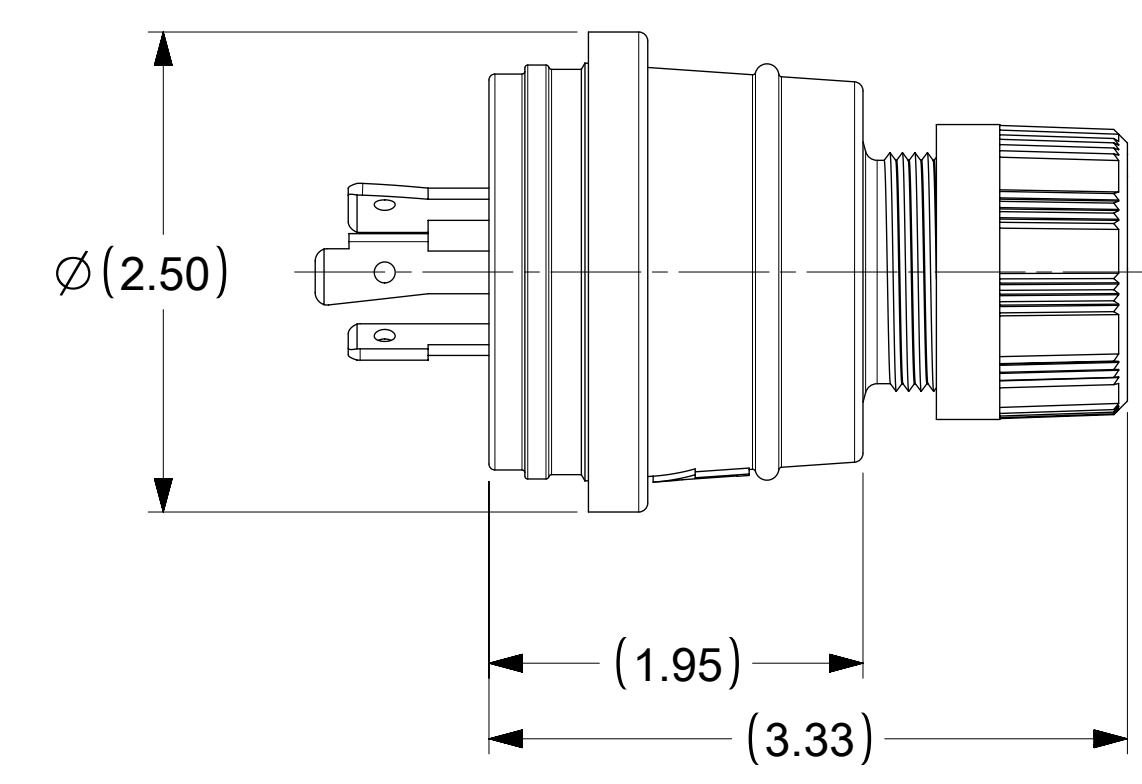

ITEM NO.	DESCRIPTIONS	MATERIAL	QTY.
1	BLADE	BRASS, NICKEL PLATED	3
2	RETAINING SCREWS	STAINLESS STEEL	3
3	CLAMP AND TERMINAL SCREW ASSY	BRASS, ZINC PLATED	3
4	INSERT	NYLON	1
5	TERMINAL COVER	POLYCARBONATE	1
6	HOUSING	SILICON WITH NYLON THREAD	1
7	GROMMET	RUBBER	1
8	FRICTION RING	NYLON	1
9	COMPRESSION NUT	NYLON	1

SYMBOLS		THIS DRAWING CONTAINS INFORMATION THAT IS PROPRIETARY TO MOLEX ELECTRONIC TECHNOLOGIES, LLC AND SHOULD NOT BE USED WITHOUT WRITTEN PERMISSION	
▽ = 0	DIMENSION UNITS	SCALE	CURRENT REV DESC: RELEASED
▽ = 0	INCH	NTS	
▽ = 0	GENERAL TOLERANCES (UNLESS SPECIFIED)		
▽ = 0	ANGULAR TOL	± °	
▽ = 0	4 PLACES	±	EC NO: 614203
▽ = 0	3 PLACES	±	DRWN: DSOPPIN 2018/12/12
▽ = 0	2 PLACES	±	CHK'D: DNGUYEN62 2019/03/25
▽ = 0	1 PLACE	±	APPR: HKNEELAND 2019/03/27
▽ = 0	0 PLACES	±	INITIAL REVISION:
▽ = 0	DRAFT WHERE APPLICABLE MUST REMAIN WITHIN DIMENSIONS		DRWN: DSOPPIN 2018/12/12
▽ = 0	THIRD ANGLE PROJECTION		APPR: HKNEELAND 2019/03/27
	DRAWING	SERIES	DOCUMENT NUMBER
	C-SIZE	130147	1301470227
	MATERIAL NUMBER	CUSTOMER	DOC TYPE DOC PART REVISION
	SEE TABLE	GENERAL MARKET	PSD 000 A
			SHEET NUMBER
			1 OF 1