

MODEL: SJ-3502-SMT-TR | **DESCRIPTION:** MID MOUNT AUDIO JACK**FEATURES**

- mid mount for low profile applications
- shielded
- no internal switches

**SPECIFICATIONS**

parameter	conditions/description	min	typ	max	units
rated input voltage			12		Vdc
rated input current				1	A
contact resistance	between terminal and mating plug between terminal in a closed circuit			50 30	mΩ mΩ
insulation resistance	at 500 Vdc	100			MΩ
voltage withstand	for 1 minute			500	Vac
insertion/withdrawal force		0.3		3	kg
operating temperature		-25		85	°C
life	at a rate of 24 cycles/minute		5,000		cycles
flammability rating	UL94V-0				
RoHS	yes				

SOLDERABILITY

parameter	conditions/description	min	typ	max	units
reel storage	10~30°C, <70% humidity				°C
reflow soldering ¹	see reflow profile	255	260		°C
drying conditions ²	parts in reel: bake at 110°C for 4 hours parts removed from reel: bake at 110°C for 4 hours				

- Note:
1. CUI Devices recommends to solder within 72 hours from opening vacuum packaging at a temperature <30°C & relative humidity <60%.
 2. When exceeding floor life by >240 hours.

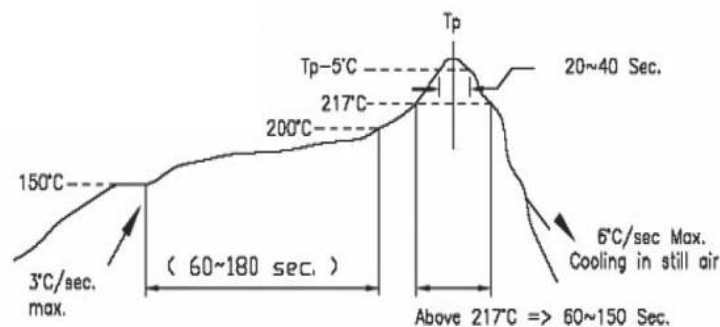

- * Time 25°C to Peak Temp. ---- 8 Minutes Max.
- * Time within 5°C of Actual Peak Temp. -- 20~40 Seconds

MECHANICAL DRAWING

units: mm
 tolerance:
 X.X ±0.2 mm
 X.XX ±0.10 mm
 X.XXX ±0.050 mm
 PCB: ±0.05 mm
 unless otherwise specified

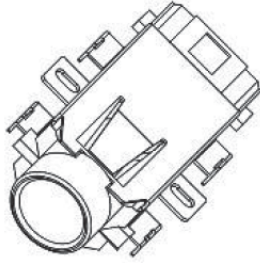

DESCRIPTION	MATERIAL	PLATING/COLOR
terminal 1	stainless steel	silver
terminal 2	copper alloy	silver
terminal 3	copper alloy	silver
housing	PA6T [UL94V-0]	black

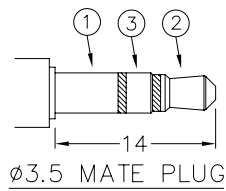
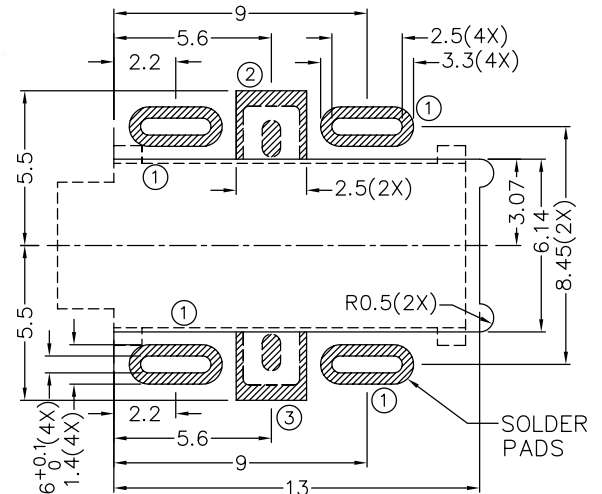
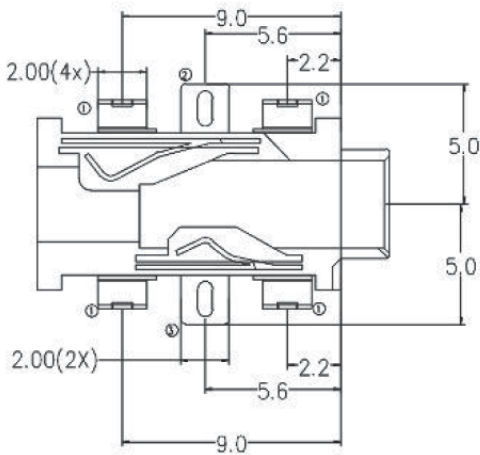
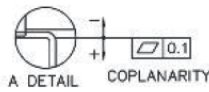
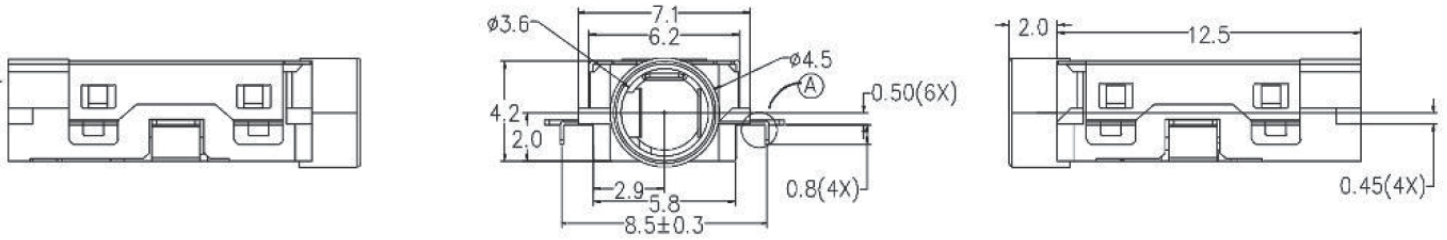

Model No.	SJ-3502-SMT-TR
Schematic	
PIN	
1	sleeve
2	tip
3	ring

PACKAGING

units: mm

Reel Size: $\varnothing 381$ mm
Reel QTY: 1,200 pcs per reel

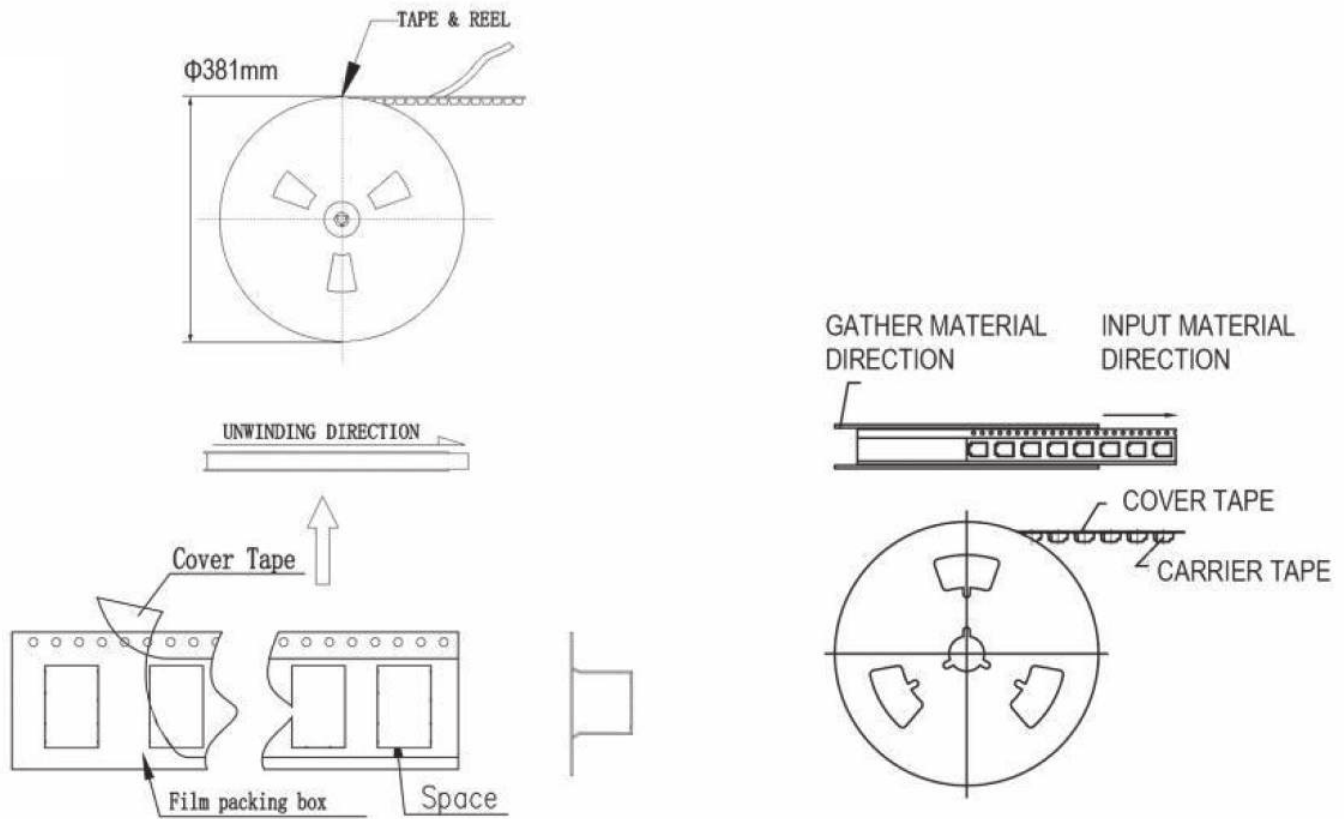

REVISION HISTORY

rev.	description	date
1.0	initial release	06/28/2011
1.01	added TR package option, updated spec.	11/28/2012
1.02	added storage and drying conditions, and tape and reel packaging details	02/16/2018
1.03	added detail to PCB layout recommendation	08/06/2019
1.04	brand update	10/08/2019
1.05	product reengineered for improved manufacturability and production yield, see PCN for details	07/10/2023

The revision history provided is for informational purposes only and is believed to be accurate.



CUI Devices offers a one (1) year limited warranty. Complete warranty information is listed on our website.

CUI Devices reserves the right to make changes to the product at any time without notice. Information provided by CUI Devices is believed to be accurate and reliable. However, no responsibility is assumed by CUI Devices for its use, nor for any infringements of patents or other rights of third parties which may result from its use.

CUI Devices products are not authorized or warranted for use as critical components in equipment that requires an extremely high level of reliability. A critical component is any component of a life support device or system whose failure to perform can be reasonably expected to cause the failure of the life support device or system, or to affect its safety or effectiveness.

cuiddevices.com