



PCB Mount as small as
3.5"L x 2.5"W x 0.98"H



Chassis 4.76"L x 2.56"W x 1.0"H

- Single / Dual / Triple Outputs
- Universal 90 to 264VAC Input
- 3.3VDC to 24VDC Outputs
- 4,000VAC Input to Output Isolation
- PCB and Chassis Mount Packages
- Full Safety Approvals



Model Number	Output Voltage	Output Amps	Output Watts
SINGLE OUTPUT - PCB Mount			
MSMA-0300	3.3 VDC	7.5	25W
MSMA-0301	5 VDC	6	30W
MSMA-0302	12 VDC	2.5	30W
MSMA-0303	15 VDC	2	30W
MSMA-0305	24 VDC	1.25	30W
SINGLE OUTPUT - Chassis Mount			
MSMC-0300	3.3 VDC	7.5	25W
MSMC-0301	5 VDC	6	30W
MSMC-0302	12 VDC	2.5	30W
MSMC-0303	15 VDC	2	30W
MSMC-0305	24 VDC	1.25	30W
SINGLE OUTPUT - DIN Rail Mount			
MSMC-0300/DRL	3.3 VDC	7.5	25W
MSMC-0301/DRL	5 VDC	6	30W
MSMC-0302/DRL	12 VDC	2.5	30W
MSMC-0303/DRL	15 VDC	2	30W
MSMC-0305/DRL	24 VDC	1.25	30W



PCB Mount as small as
3.5"L x 2.5"W x 0.98"H



Chassis 4.76"L x 2.56"W x 1.0"H

- Single / Dual / Triple Outputs
- Universal 90 to 264VAC Input
- 3.3VDC to 24VDC Outputs
- 4,000VAC Input to Output Isolation
- PCB and Chassis Mount Packages
- Full Safety Approvals



Model Number	Output Voltage	Output Amps	Output Watts
DUAL OUTPUT - PCB Mount			
MDMA-0306	±12 VDC	±1.25	30W
MDMA-0307	±15 VDC	±1	30W
MDMA-0308	+5/12 VDC	3/1.25	30W
DUAL OUTPUT - Chassis Mount			
MDMC-0306	±12 VDC	±1.25	30W
MDMC-0307	±15 VDC	±1	30W
MDMC-0308	+5/12 VDC	3/1.25	30W
DUAL OUTPUT - DIN Rail Mount			
MDMC-0306/DRL	±12 VDC	±1.25	30W
MDMC-0307/DRL	±15 VDC	±1	30W
MDMC-0308/DRL	+5/12 VDC	3/1.25	30W
TRIPLE OUTPUT - PCB Mount			
MTMA-0309	+5,±12 VDC	3,0.63/0.63	30W
MTMA-0311	+5,±15 VDC	3,0.5/0.5	30W
TRIPLE OUTPUT - Chassis Mount			
MTMC-0309	+5,±12 VDC	3,0.63/0.63	30W
MTMC-0311	+5,±15 VDC	3,0.5/0.5	30W
TRIPLE OUTPUT - DIN Rail Mount			
MTMC-0309/DRL	+5,±12 VDC	3,0.63/0.63	30W
MTMC-0311/DRL	+5,±15 VDC	3,0.5/0.5	30W

INPUT SPECIFICATIONS

Input Voltage	90-264VAC; Nominal: 100-240VAC
Input Frequency	47-440 Hz, Nominal: 50-60Hz
Inrush Current (100V / 200V)	Cold Start, 20A / 40A, typ
Leakage Current	<0.3mA @ 264VAC, 50Hz

OUTPUT SPECIFICATIONS

Output Voltage/Current	See Specific Model
Initial Accuracy	±1%, adjustable
Voltage Adjust	±6%, typ
Load Regulation (20%-100%)	±0.3%, typ
Line Regulation	±0.3%, typ
Cross Regulation	±3%, typ
Temperature Coefficient	±0.03%/°C
Ripple/Noise(20Mhz BW)	150mV Pk-Pk, typ
Overvoltage Protection	Clamp, 130-150% *
Hold Up Time	30mS, typ
Short Circuit Protection	Continuous, self-recovering *
Current Limit	130% typ, self-recovering

GENERAL SPECIFICATIONS

On/Off Control	Open Collector
	Logic "1"/Open=ON
	Logic "0"/GND=OFF
Input-Out Isolation	4000VAC
Output-Ground Isolation	1000VAC
Input-Ground Isolation	2500VAC
Operating Frequency	140 Khz, typ., fixed
Efficiency (@ Full Load)	75 - 80%, typ (3.3V: 70% typ.)
Safety UL/cUL:	ANSI/AAMI ES60601-1 3rd ed.
	CSA C22.2 No. 60601-1 3rd ed.
UL-EU:	EN60601-1 3rd ed.
CB:	IEC60601-1 3rd ed.
CE:	EN60601-1-2
EMI	EN55011 Class B

All specifications are typical at nominal input, full load, and 25DegC unless otherwise noted

ENVIRONMENTAL SPECIFICATIONS

Oper. Temperature	0 to +50°C FL See Derate *
	(Free-air Convection)
Relative Humidity	0-95%, Non-Condensing
Storage Temperature	-25 to +71°C *
MTBF, Single/Multi Output	180,000 Hrs/110,000 Hrs
	Mil Std 217, 25C

PHYSICAL SPECIFICATIONS

Case Material	Rynite, 94V-0 Rated
Construction	Encapsulated, Soft Pot
Size PCB Mount	Single O/P: 3.5" x 2.5" x 0.98"
	Multi O/P: 4.06" x 2.5" x 0.98"
Chassis Mount	Single O/P: 4.76" x 2.56" x 1.0"
	Multi O/P: 5.34" x 2.56" x 1.0"
Weight PCB / CHASSIS	
Singles	10.4 oz (295g) / 13.4 oz (380g)
Duals/Triples	12.1 oz (343g) / 15.4 oz (437g)

* These are stress ratings. Exposure of the devices to any of these conditions may adversely affect long term reliability. Proper operation under conditions other than the standard operating conditions is neither warranted nor implied.

MECHANICAL DIMENSIONS - PCB MOUNT - SINGLE OUTPUT

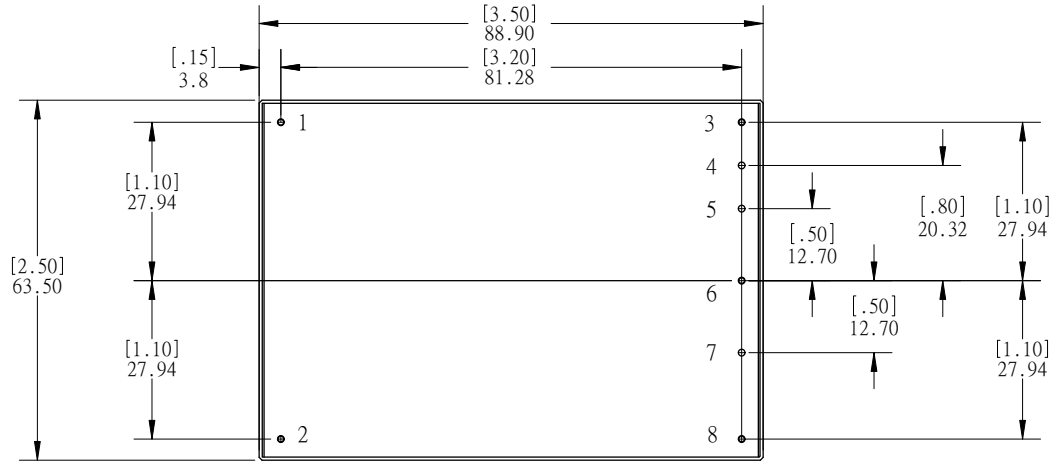

PIN - OUT VIEWED FROM BOTTOM

Model Type/Pin#	Single
1	AC HI
2	AC LO
3	No Pin
4	No Pin
5	No Pin
6	-Vout
7	No Pin
8	+Vout

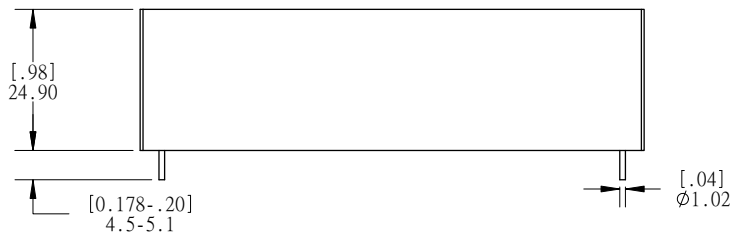

NOTES:
1. All dimension in mm [inch].
2. tolerance : .XX±0.254 [0.01].
.XXX±0.13[0.005].

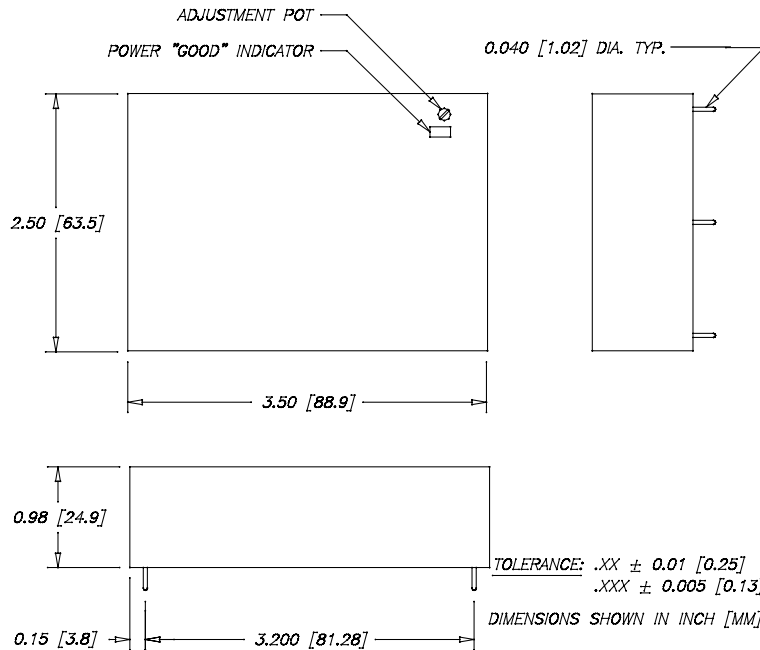

MECHANICAL DIMENSIONS - PCB MOUNT - DUAL & TRIPLE OUTPUT

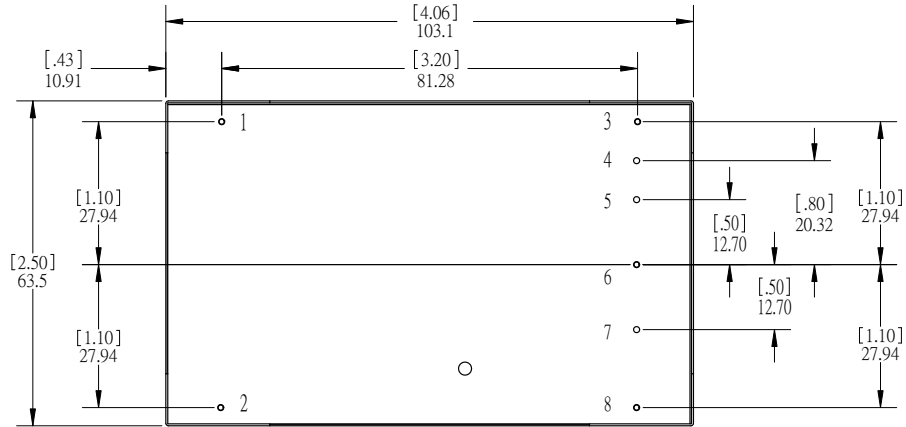

PIN-OUT VIEWED FROM BOTTOM

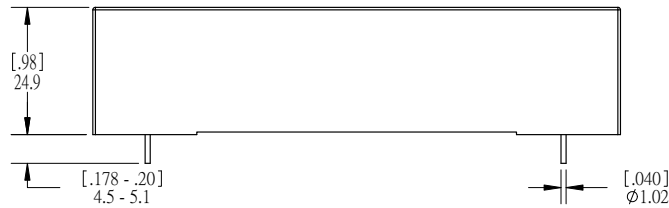

Model Type/Pin#	Dual Matched	Dual (5/12V)	Triple
1	AC HI	AC HI	AC HI
2	AC LO	AC LO	AC LO
3	-Vout	COM	-Vout
4	No Pin	No Pin	No Pin
5	No Pin	No Pin	+5VRTN
6	COM	+5Vout	+/-COM
7	No Pin	No Pin	+5Vout
8	+Vout	+12Vout	+Vout

- NOTES :
1. All dimension in mm [inch] .
 2. tolerance : .XX±0.254 [0.01] ;
.XXX±0.13[0.005].

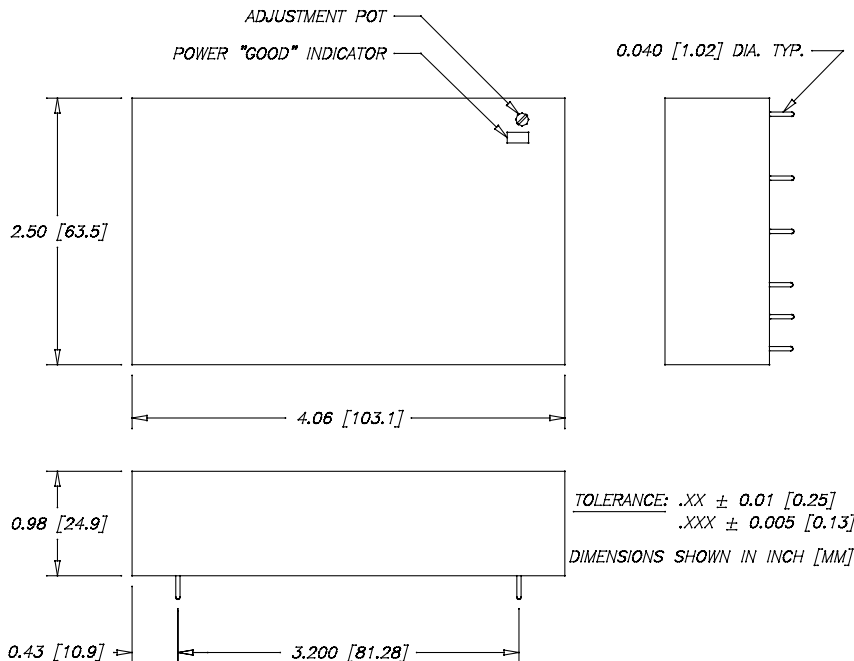

MECHANICAL DIMENSIONS - CHASSIS MOUNT

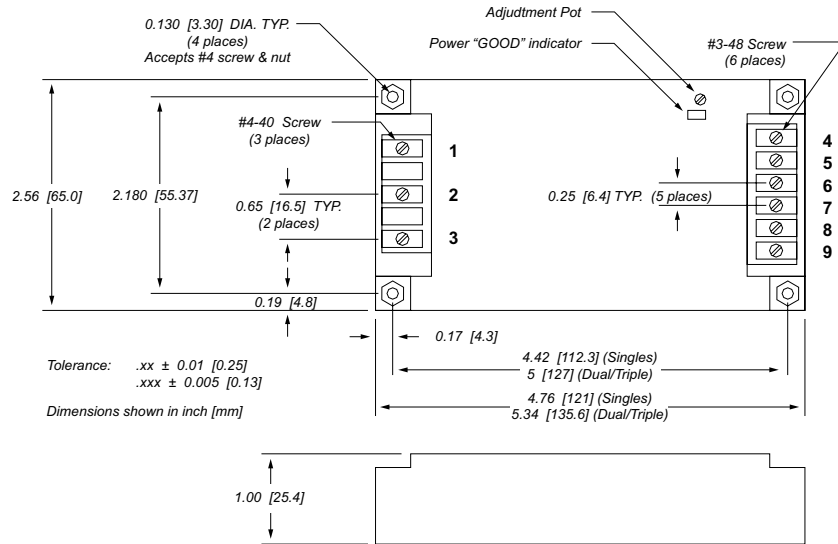

MECHANICAL DIMENSIONS - DIN RAIL

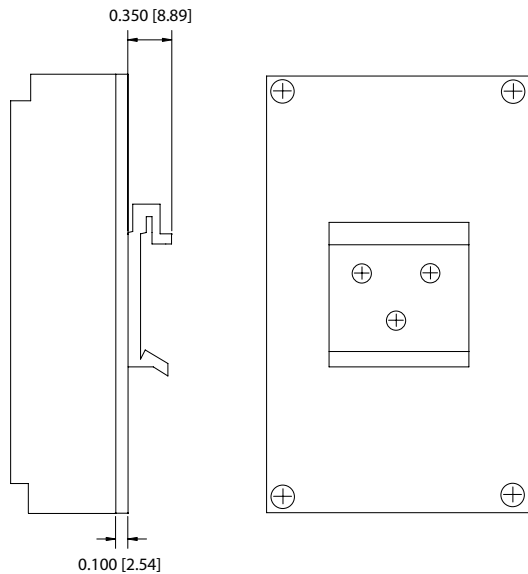

Model Type / Pin#	Match			
	Single	Dual	Unmatch Dual	Triple
1	AC LO	AC LO	AC LO	AC LO
2	GND	GND	GND	GND
3	AC HI	AC HI	AC HI	AC HI
4	+Vout	+Vout	+12Vout	+Vout
5	+Vout	Com	+5Vout	+5Vout
6	-Vout	Com	+5Vout	± Com
7	-Vout	-Vout	Com	+5V Ret
8	N/C	N/C	Com	-Vout
9	Ctrl	Ctrl	Ctrl	Ctrl

DIN Rail mounting kit available for Chassis-mount modules.
 - For 30 watt single outputs specify part # M-DRL-30S
 - For 30 watt dual/single outputs specify part # M-DRL-30T
 Kit includes mounting plate, DIN Rail cliip and assembly hardware.

DERATE CURVE

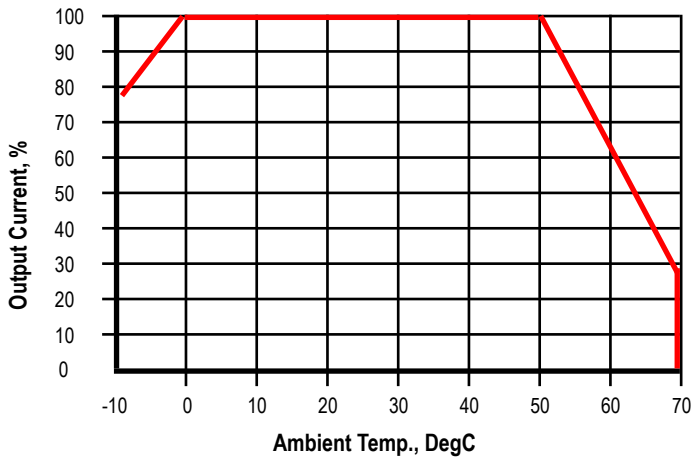

EFFICIENCY CURVE

