

IEC Appliance Inlet C14 with Filter, Fuseholder 1- or 2-pole, Line Switch 2-pole, for PCB Mounting



See below:  
[Approvals and Compliances](#)

**Description**

- Panel mount :  
Screw-on mounting on PCB , rear-side
- 4 Functions :  
Appliance Inlet Protection class I , Line Switch 2-pole , Fuseholder for fuse-links 5 x 20 mm 1- or 2-pole , Line filter in standard and medical version
- V-Lock notch standard
- PCB terminals

**Unique Selling Proposition**

- Most compact power entry module
- Attractive flat design
- Switch for highest inrush current
- V-Lock cord retaining

**Characteristics**

- Ultra-compact design. Ideal for low profile designs
- All single elements are already wired
- For added safety "Extra-Safe" fuse drawers are available
- Ideal for application with high transient loads
- For applications according IEC/UL 62368-1 we recommend variants with bleed resistor  
Suitable for use in medical equipment according to IEC/UL 60601-1 (1 MOOP, 1 MOPP)

**Other versions on request**

- Fuse drawer 1-pole, plus spare fuse case
- Fuse drawer 2-pole, with shorting bar
- Other rocker marking
- Line switch, illuminated
- Line switch 1-pole
- Medical Version (M80)
- Protection class II, 70°C

**References**

Alternative: version without line filter [DD21](#)  
 Alternative: Standard version

**Weblinks**

[pdf data sheet](#), [html datasheet](#), [General Product Information](#), [Approvals](#), [Distributor-Stock-Check](#), [Accessories](#), [Detailed request for product](#)

**Technical Data**

Ratings IEC	1 - 10A @ Ta 40 °C / 250VAC; 50Hz	Appliance inlet/-outlet	C14 acc. to IEC 60320-1
Ratings UL/CSA	1 - 10A @ Ta 40 °C / 250VAC; 50/60Hz	Fuseholder	UL 498 CSA C22.2 no. 42 (for cold conditions) pin-temperature 70 °C, 10A, Protection Class I
Leakage Current	standard < 0.5 mA (250 V / 60Hz) medical < 5 µA (250 V / 60 Hz)	Rated Power Acceptance @ Ta 23 °C	1-/2-pole, Shocksafe category PC2 acc. to IEC 60127-6, for fuse-links 5 x 20mm
Dielectric Strength	> 1.7 kVDC between L-N > 2.7 kVDC between L/N-PE Test voltage (1 min/50Hz)	Power Acceptance @ Ta > 23°C	5 x 20: 2W (1 pole)/ 1.6W (2-pole) per pole
Allowable Operation Temperature	-25 °C to 85 °C	Line Switch	Admissible power acceptance at higher ambient temperature see derating curves
Climatic Category	25/085/21 acc. to IEC 60068-1	Line Filter	Rocker switch 2-pole, non-illuminated, acc. to IEC 61058-1 <a href="#">Technical Details</a>
IP-Protection	front side IP40 acc. to IEC 60529	Material	Standard and Medical Version, IEC 60939, UL 1283, CSA C22.2 no. 8 <a href="#">Technical Details</a>
Protection Class	Suitable for appliances with protection class I acc. to IEC 61140	MTBF	> 2'000'000 h acc. to MIL-HB-217 F
Terminal	For PCB mounting 3 mm additional quick connect 6.3 x 0.8 mm		
Panel Thickness S	Screw-on mounting: max 3mm Mounting screw torque max 0.5Nm		
Material	Thermoplastic, black, UL 94V-0		

**Approvals and Compliances**



Detailed information on product approvals, code requirements, usage instructions and detailed test conditions can be looked up in [Details about Approvals](#)

SCHURTER products are designed for use in industrial environments. They have approvals from independent testing bodies according to national and international standards. Products with specific characteristics and requirements such as required in the automotive sector according to IATF 16949, medical technology according to ISO 13485 or in the aerospace industry can be offered exclusively with customer-specific, individual agreements by SCHURTER.

## Approvals









The approval mark is used by the testing authorities to certify compliance with the safety requirements placed on electronic products.

Approval Reference Type: DD22

Approval Logo	Certificates	Certification Body	Description
	<a href="#">VDE Approvals</a>	VDE	Certificate Number: 40001522
	<a href="#">UL Approvals</a>	UL	UR File Number: E72928



## Product standards

Product standards that are referenced

Organization	Design	Standard	Description
	Designed according to	IEC 60320-1	Appliance couplers for household and similar general purposes
	Designed according to	IEC 60939	Passive filters for suppressing electromagnetic interference
	Designed according to	IEC 60127-6	Miniature fuses. Part 6. Fuse-holders for miniature fuse-links
	Designed according to	IEC 61058-1	Switches for appliances. Part 1. General requirements
	Designed according to	UL 498	Standard for Attachment Plugs and Receptacles
	Designed according to	UL 1283	Electromagnetic interference filters
	Designed according to	CSA C22.2 no. 42	General Use Receptacles, Attachment Plugs, and Similar Wiring Devices
	Designed according to	CSA C22.2 no. 8	Electromagnetic interference (EMI) filters









## Application standards

Application standards where the product can be used

Organization	Design	Standard	Description
	Suitable for applications acc.	IEC/UL 62368-1	Audio/video, information and communication technology equipment - Part 1: Safety requirements
	Suitable for applications acc.	IEC 60601-1	Medical electrical equipment - Part 1: General requirements for basic safety and essential performance
	Suitable for applications acc.	IEC 60335-1	Safety of electrical appliances for household and similar purposes. Meets the requirements for appliances in unattended use. This includes the enhanced requirements of glow wire tests acc. to IEC 60695-2-11 or -12 & -13.

### Compliances

The product complies with following Guide Lines

Identification	Details	Initiator	Description
	<a href="#">CE declaration of conformity</a>	SCHURTER AG	The CE marking declares that the product complies with the applicable requirements laid down in the harmonisation of Community legislation on its affixing in accordance with EU Regulation 765/2008.
	<a href="#">UKCA declaration of conformity</a>	SCHURTER AG	The UKCA marking declares that the product complies with the applicable requirements laid down in the British Amendment of Regulation (EC) 765/2008.
	RoHS	SCHURTER AG	Directive RoHS 2011/65/EU, Amendment (EU) 2015/863
	China RoHS	SCHURTER AG	The law SJ / T 11363-2006 (China RoHS) has been in force since 1 March 2007. It is similar to the EU directive RoHS.
	REACH	SCHURTER AG	On 1 June 2007, Regulation (EC) No 1907/2006 on the Registration, Evaluation, Authorization and Restriction of Chemicals 1 (abbreviated as "REACH") entered into force.
		SCHURTER AG	V-Lock system are based on a matching plug-dose combination. The connector is equipped with a notch intended for use with the latching cordset. The cord latching system prevents against accidental removal of the cordset.
	<a href="#">White Paper Glow wire test</a>	SCHURTER AG	Meets the requirements of IEC 60335-1 for appliances in unattended use. This includes the enhanced requirements of glow wire tests acc. to IEC 60695-2-11 or -12 &-13.
	<a href="#">Medical Equipment</a>	SCHURTER AG	Suitable for use in medical equipment according to IEC/UL 60601-1 (1 MOOP, 1 MOPP)

### Dimension [mm]

Screw-on version

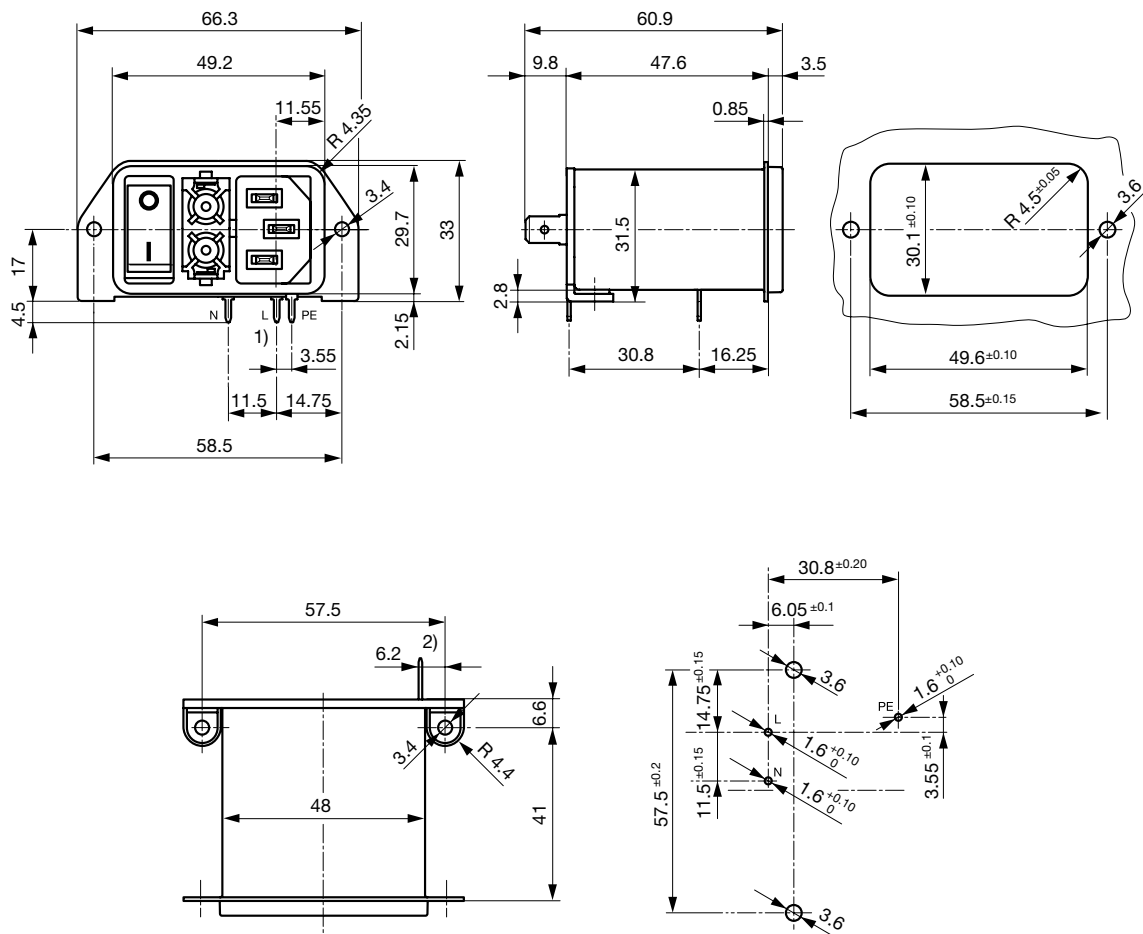

1) all terminals with 1.25 x 0.8  
 2) Quick connect terminal 6.3 x 0.8

**Technical Data of Filter-Components**

Rated Current [A]	Filter-Type	Inductances L [mH]	Capacitance CX [nF]	Capacitance CY [nF]	R [MΩ]
1	Standard version	2 x 10	100	2.2	1
2	Standard version	2 x 4	100	2.2	1
4	Standard version	2 x 1.5	100	2.2	1
6	Standard version	2 x 0.8	100	2.2	1
10	Standard version	2 x 0.3	100	2.2	1
1	Medical Version (M5)	2 x 10	100	-	1
2	Medical Version (M5)	2 x 4	100	-	1
4	Medical Version (M5)	2 x 1.5	100	-	1
6	Medical Version (M5)	2 x 0.8	100	-	1
10	Medical Version (M5)	2 x 0.3	100	-	1

**Diagrams**

Medical Version (M5)  
 Non-illuminated

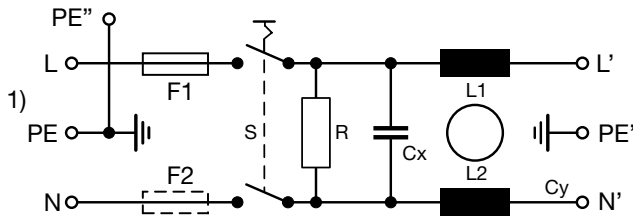

1) Line  
 2) Load

Filter Standard  
 Non-illuminated

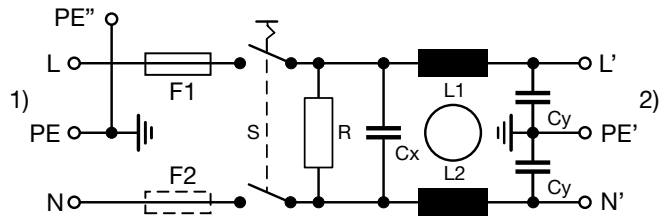

1) Line  
 2) Load

**Derating Curves**

2-pole

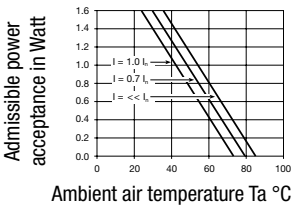

1-pole

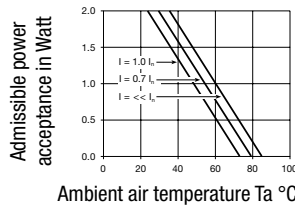

**Attenuation Loss**

--- 50Ω differential mode \_\_\_\_ 50Ω common mode

Standard version

10 A

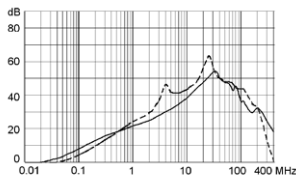

6 A

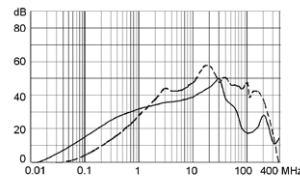

4 A

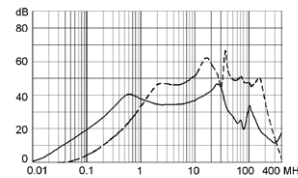

2 A

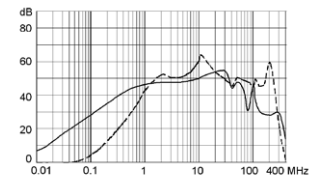

1 A

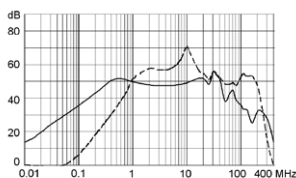

Medical version (M5)

10 A

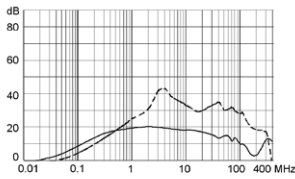

6 A

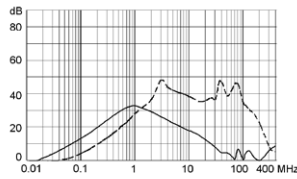

4 A

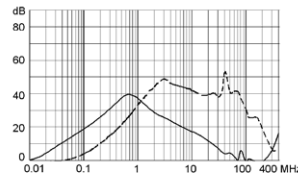

2 A

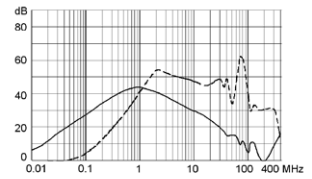

1 A

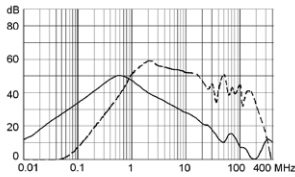

All Variants

Rated Current [A]	Filter-Type	Fuseholder	Line Switch	Illumination	Order Number
1	Standard version	1-pole	2-pole	non-illuminated	DD22.1111.1111
2	Standard version	1-pole	2-pole	non-illuminated	DD22.2111.1111
4	Standard version	1-pole	2-pole	non-illuminated	DD22.4111.1111
6	Standard version	1-pole	2-pole	non-illuminated	DD22.6111.1111
10	Standard version	1-pole	2-pole	non-illuminated	DD22.9111.1111
1	Standard version	2-pole	2-pole	non-illuminated	DD22.1121.1111
2	Standard version	2-pole	2-pole	non-illuminated	DD22.2121.1111
4	Standard version	2-pole	2-pole	non-illuminated	DD22.4121.1111
6	Standard version	2-pole	2-pole	non-illuminated	DD22.6121.1111
10	Standard version	2-pole	2-pole	non-illuminated	DD22.9121.1111
1	Medical Version (M5)	2-pole	2-pole	non-illuminated	DD22.1321.1111
2	Medical Version (M5)	2-pole	2-pole	non-illuminated	DD22.2321.1111
4	Medical Version (M5)	2-pole	2-pole	non-illuminated	DD22.4321.1111
6	Medical Version (M5)	2-pole	2-pole	non-illuminated	DD22.6321.1111
10	Medical Version (M5)	2-pole	2-pole	non-illuminated	DD22.9321.1111

Availability for all products can be searched real-time: <https://www.schurter.com/en/Stock-Check/Stock-Check-SCHURTER>

The fuse drawer is not included and must be ordered separately (see required accessory).

Packaging unit

20 Pcs

Required Accessory

Description

Fusedrawer\_2  
 Fusedrawer for Fuse Links 5x20 mm, with or without Voltage Selector Insert



Fingergrip, 2-pole	4301.1401
Extra-Safe, 2-pole	4301.1403
Fingergrip, 1-pole	4301.1405
Extra-Safe, 1-pole	4301.1407

...

**Mating Outlets/Connectors**

**Category / Description**

[Appliance Outlet Overview complete](#)



4787, Mounting: Screw-on mounting, Appliance Outlet: IEC Solder terminals, 10 A, Suitable for appliances with protection class I	4787
4788, Mounting: Snap-in version, Appliance Outlet: IEC Solder / Quick Connect, 10 A, Suitable for appliances with protection class I	4788
IEC Appliance Outlet F or H, Screw-on Mounting, Front Side, Solder, PCB or Quick-connect Terminal	5091

[Connector Overview complete](#)



4782 Mounting: Power Cord, 3 x 1 mm <sup>2</sup> / 3 x 18 AWG, Cable, Connector: IEC C13	4782
4785 Mounting: Power Cord, 3 x 1 mm <sup>2</sup> / 3 x 18 AWG, Cable, Connector: IEC C13	4785
4300-06 Mounting: Power Cord, 3 x 1 mm <sup>2</sup> / 3 x 18 AWG, Cable, Connector: IEC C13	4300-06
4781 Mounting: Power Cord, Cable, Connector: IEC C15	4781
4784 Mounting: Power Cord, 3 x 1 mm <sup>2</sup> / 3 x 18 AWG, Cable, Connector: IEC C15	4784

**Mating Outlets/Connectors shuttered**

[Connector Overview complete](#)



4783 Mounting: Power Cord, 3 x 1 mm <sup>2</sup> / 3 x 18 AWG, Cable, Connector: IEC C13	4783
--	------

[Power Cord Overview complete](#)



VAC13KS, Overview, V-Lock cord retaining, diverse Connector IEC C13, diverse, black	VAC13KS
---	---------